



# NM-Germany

## PISTON & RINGS FOR EUROPEAN MOTORS

Kolben & Ringe  
für europäische Motoren

Pistón & Anillos  
para los motores de europeo

Piston & Segments  
pour les moteurs européens



# EK1

# CUSTOMER'S RESPONSIBILITY

## Verantwortung des Kunden

Dieser Katalog dient lediglich zur Referenz. Obwohl jede Anstrengung unternommen wurde, um sicherzustellen, dass die in diesem Katalog aufgeführten Informationen zutreffend sind, übernimmt NM-Germany keine Verantwortung für eventuelle Fehler und/ oder Auslassungen und haftet nicht für direkte oder indirekte Schäden, die aus der Nutzung dieser Informationen resultieren. Wir freuen uns über Feedback bezüglich eventuellen Fehlern oder Ergänzungen in diesem Katalog.

Für die technisch richtige Verwendung der Artikel ist der Kunde verantwortlich. Wichtige Informationen ergeben sich aus den technischen Hinweisen der Fahrzeughersteller. In Zweifelsfällen beraten wir Sie gern. Bitte sprechen Sie uns an unter:

**Tel.:** + 49 (0) 2568 / 93 44 -0  
**Fax:** + 49 (0) 2568 / 93 44 11  
**E-Mail:** [info@nm-germany.com](mailto:info@nm-germany.com)

MfG,  
Ihr



**NM-Germany**  
Engine Components Team



## Customer's responsibility

This is a parts reference catalogue only. Whilst every endeavor has been made to ensure the accuracy of the information, no liability will be accepted for any errors or omissions. Accordingly, claims originating from information contained in this catalogue cannot be recognized. We would be pleased to receive any advice on any errors or additions which may come to your attention.

Responsibility for correct technical use complying with standards and specifications shall be borne by the customers. Important advice may also be obtained from the technical information by car manufacturers. In case of any doubt feel free to contact us.

**Phone:** + 49 (0) 2568 / 93 44 -0  
**Fax:** + 49 (0) 2568 / 93 44 11  
**E-Mail:** [info@nm-germany.com](mailto:info@nm-germany.com)

Sincerely,  
Yours



**NM-Germany**  
Engine Components Team



# PISTON TERMINOLOGY

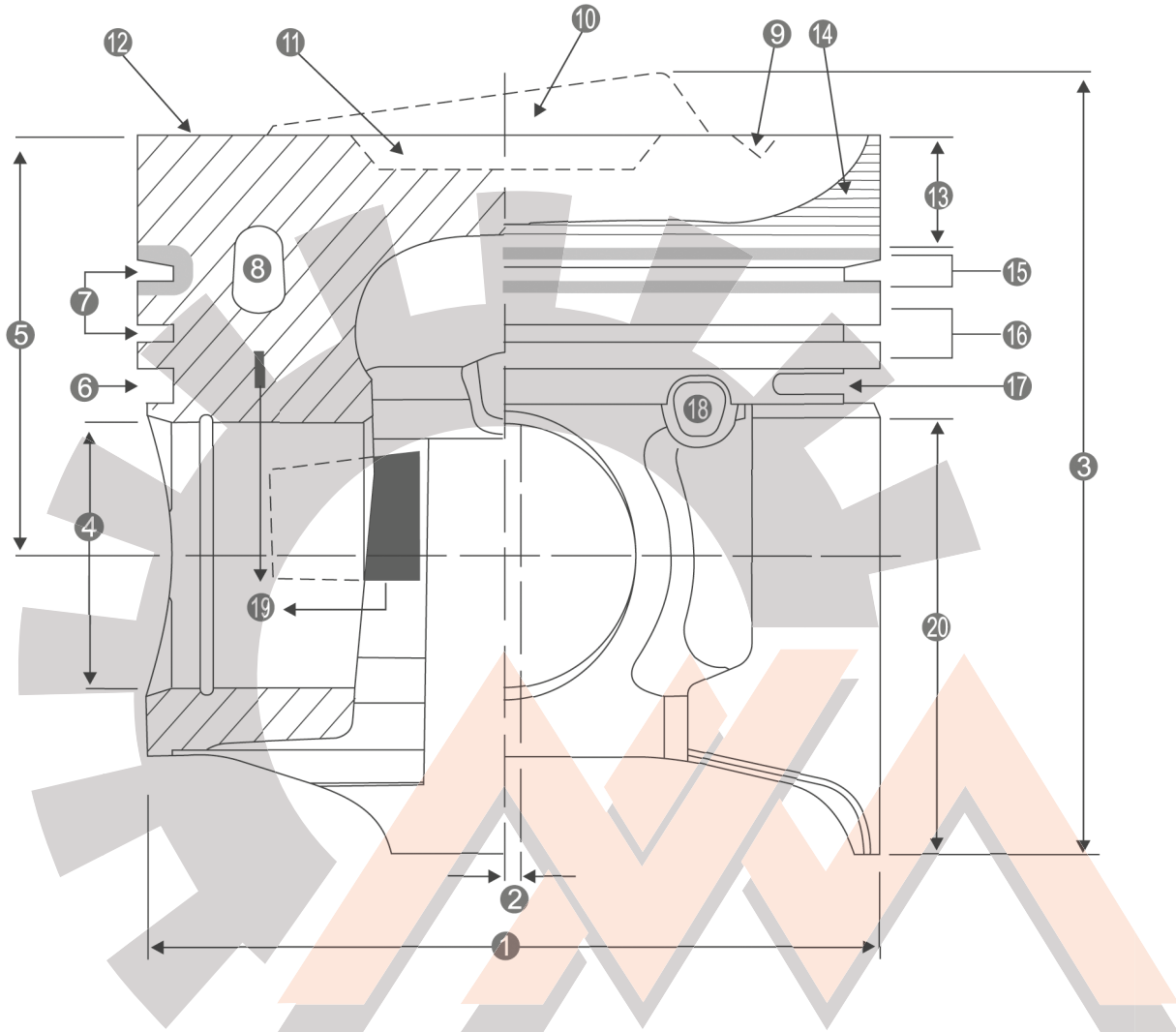

- |   |                           |
|---|---------------------------|
| ① Piston skirt diameter                   | ⑪ Combustion-chamber bowl |
| ② Piston offset                           | ⑫ Piston crown            |
| ③ Total piston length                     | ⑬ Top land                |
| ④ Piston pin hole diameter                | ⑭ Anti-scuff bands        |
| ⑤ Compression height                      | ⑮ Alfin (Ring carrier)    |
| ⑥ Oil ring groove                         | ⑯ Ring land               |
| ⑦ Top and second compression ring grooves | ⑰ Oil slit groove         |
| ⑧ Oil gallery (Oil cooling channel)       | ⑱ Oil return hole         |
| ⑨ Valve recess depth                      | ⑲ Hidden steel struts     |
| ⑩ Crown chamber                           | ⑳ Skirt area              |



**NM-Germany**  
Engine Components

# LINER / SLEEVE TERMINOLOGY

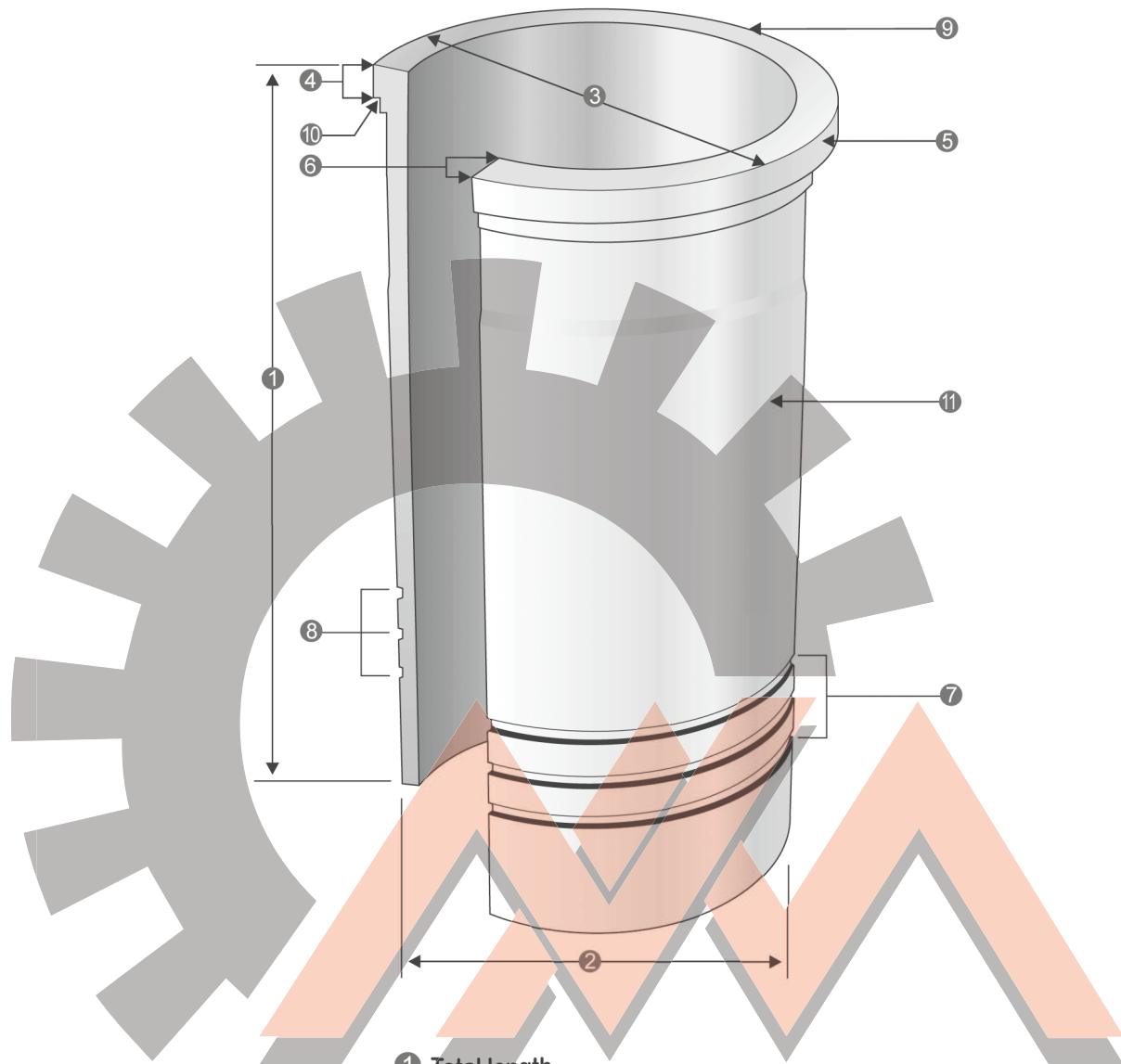

- ① Total length
- ② Outside diameter
- ③ Flange diameter (Register diameter)
- ④ Flange depth (Collar height)
- ⑤ Flange
- ⑥ Top land width
- ⑦ Sealing area
- ⑧ O-Ring groove
- ⑨ Firewall
- ⑩ Machining relief
- ⑪ Barrel



**NM-Germany**  
Engine Components

# PISTON RINGS TERMINOLOGY

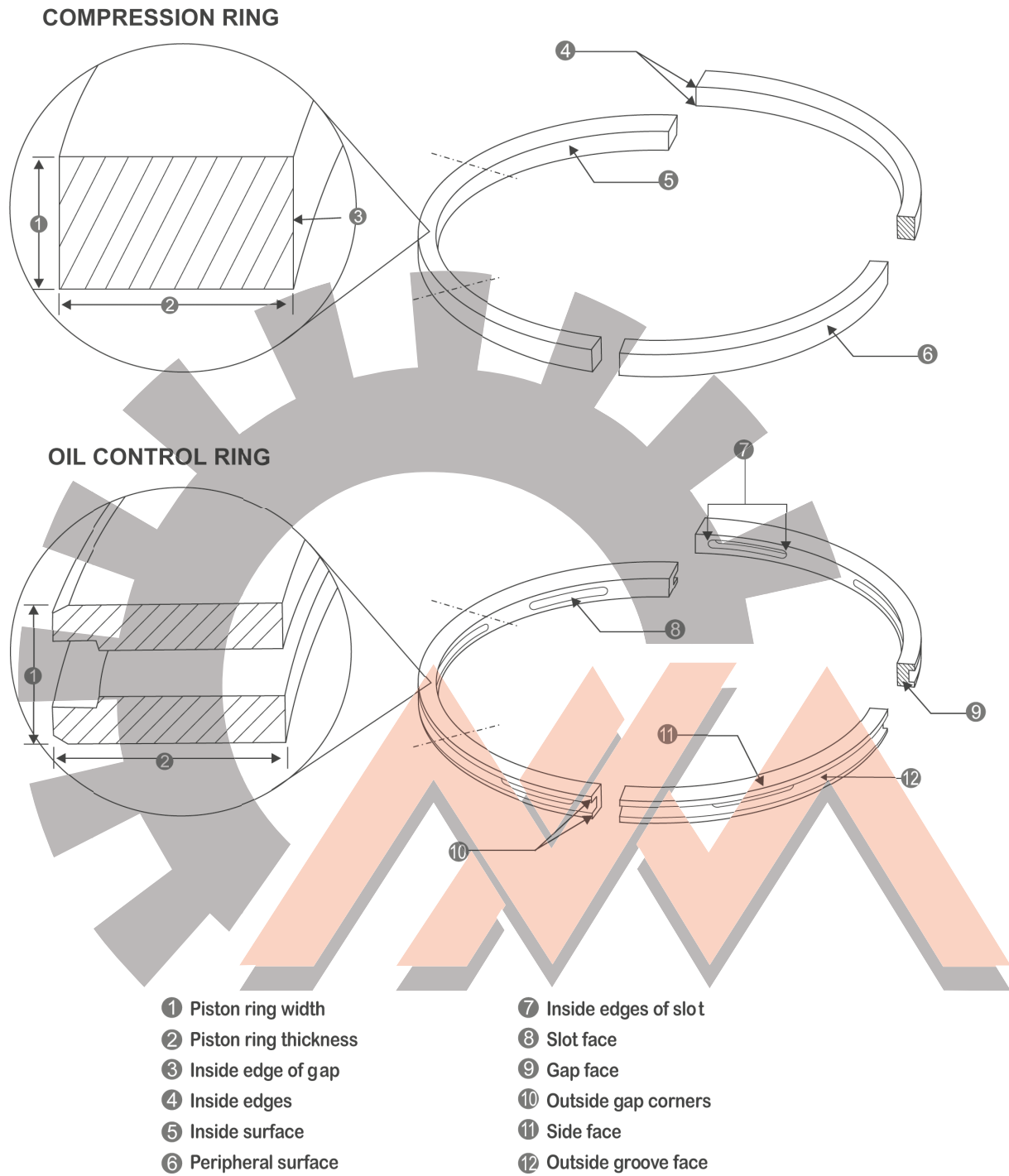

**NM-Germany**  
 Engine Components

# GUIDE TO ART. NUMBERS

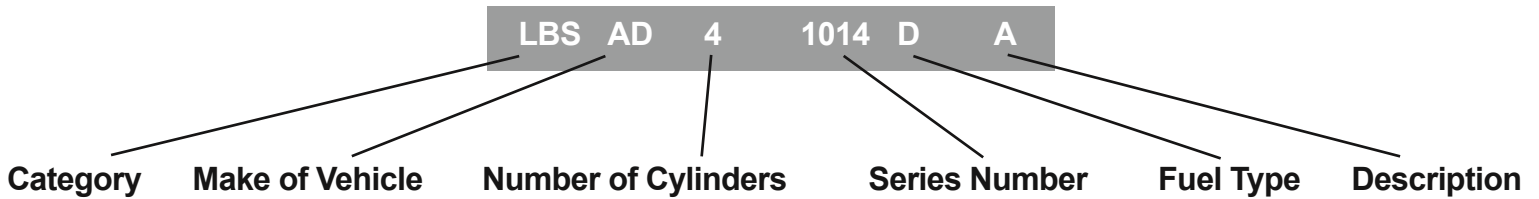

Category	Description of Engine and Liner/ Sleeve:
----------	--

**LBS = LINER KIT**  
 Liner Kit  
 camisas de los cilindros  
 Лайнер комплект  
 LBS = LB + KBS

**C = Chromed liner**  
**F = Fully-finished liner**  
**P = Semi-finished sleeve, w/ out flange**  
**S = Semi-finished sleeve**

**LB = CYL. LINER**  
 Zylinderlaufbuchse  
 camisas de los cilindros  
 втулка цилиндра

**Description of Piston:**

**A = Alfin**  
**B = Alfin and with oil gallery**  
**G = Oil gallery**

**KBS = PISTON + RINGS**  
 Kolben + Ringe  
 Pistón + Anillos  
 поршень и кольца

**Make of Vehicle**

AR-Alfa Romeo	LD-Lada
AO-ARO	LA-Lancia
AD-Audi	LR-Land Rover
AU-Austin Morris	MB-Mercedes Benz
BD-Bedford	OP-Opel Vauxhall
BM-BMW	PY-Paykan
BM-BMW_mini	PG-Peugeot
CH-Chevrolet	PS-Porsche
CS-Chrysler	RN-Renault
CI-Citroen	SA-SAAB
FI-Fiat	ST-Seat
FO-Ford	SK-Skoda
FS-FSO	TB-Talbot
GM-General Motors	VM-VM
HN-Holden	VW-VolksWagen
JG-Jaguar	VO-Volvo
JE-Jeep	ZA-Zastava

**KB = PISTON SET**  
 Kolben Set  
 Pistón Set  
 поршневой

**KR = RINGS SET**  
 Ring Set  
 Anillos Set  
 кольца

**PB = PIN**  
 Pin  
 Perno  
 Пин

**Fuel Type**

**D = DIESEL**  
**G = GASOLINE**



**Modell**  
Model/ Modelo/ Модель

**Seite**  
Page/ Página/ Страница



<b>ALFA ROMEO</b>	<b>8</b>
<b>ARO</b>	<b>13</b>
<b>AUDI</b>	<b>14</b>
<b>AUSTIN MORRIS</b>	<b>37</b>
<b>BEDFORD</b>	<b>39</b>
<b>BMW</b>	<b>40</b>
<b>BMW MINI R50</b>	<b>53</b>
<b>CHEVROLET</b>	<b>54</b>
<b>CHRYSLER</b>	<b>58</b>
<b>CITROEN</b>	<b>62</b>
<b>FIAT IVECO</b>	<b>72</b>
<b>FORD</b>	<b>96</b>
<b>FSO</b>	<b>126</b>
<b>GENERAL MOTORS</b>	<b>127</b>
<b>HOLDEN</b>	<b>129</b>
<b>JAGUAR</b>	<b>131</b>
<b>JEEP</b>	<b>132</b>
<b>LADA</b>	<b>133</b>
<b>LANCIA</b>	<b>139</b>
<b>LAND ROVER</b>	<b>144</b>
<b>MERCEDES BENZ</b>	<b>150</b>
<b>OPEL VAUXHALL</b>	<b>172</b>
<b>PAYKAN</b>	<b>204</b>
<b>PEUGEOT</b>	<b>205</b>
<b>PORSCHE</b>	<b>220</b>
<b>RENAULT</b>	<b>221</b>
<b>SAAB</b>	<b>242</b>
<b>SEAT</b>	<b>245</b>
<b>SKODA</b>	<b>259</b>
<b>TALBOT</b>	<b>269</b>
<b>VM</b>	<b>271</b>
<b>VOLKSWAGEN</b>	<b>272</b>
<b>VOLVO</b>	<b>308</b>
<b>ZASTAVA</b>	<b>315</b>







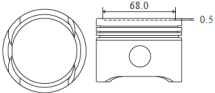

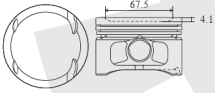

**GASOLINE**

ENGINE TYPE Motortyp Type de Moteur Tipo de motor Тип двигателя	LINER KIT Liner Kit Kit de Chemise Camisas de los cilindros лайнер комплект	CYL. LINER Zylinderlaufbuchse Chemise Camisas de los cilindros втулка цилиндра	PISTON + RINGS Kolben + Ringe Piston + Segments Pistón Set Поршень и кольца	PISTON SET Kolben Set Set de Piston Pistón Set поршеньой	RINGS SET Kolben Set Segments de Piston Anillos Set кольца	PIN Pin Axe Perno Пин
<b>AR 67106</b> 4 Cyl 82.0 mm Bore Ø 1,747 cc		Length: Outside Ø: Flange Ø: flange depth	Length: 60.15 Comp: 36.15 Height: -0.5 -3.8	skirt MOS2 treated	Top: 1.5 2nd: 1.5 3rd: 1st oil: 3.0 2nd oil:	Ø: 20.0 Length: 52.0
		Reference no.:	Reference no.:	Reference no.:	Reference no.:	O-RING
			<b>M-0630300</b>		<b>M-00944N0</b> <b>M-06303N0</b>	
NM-Germany Article no. Artikelnummer/ Modelo Número / статья НОМЕР	NM-Germany Article no.	NM-Germany Article no.	NM-Germany Article no.	NM-Germany Article no.	NM-Germany Article no.	NM-Germany Article no.
			<b>KBSAR40007G</b>	<b>KBAR40007G</b>	<b>KRAR40007G</b>	

**GASOLINE**

ENGINE TYPE Motortyp Type de Moteur Tipo de motor Тип двигателя	LINER KIT Liner Kit Kit de Chemise Camisas de los cilindros лайнер комплект	CYL. LINER Zylinderlaufbuchse Chemise Camisas de los cilindros втулка цилиндра	PISTON + RINGS Kolben + Ringe Piston + Segments Pistón Set Поршень и кольца	PISTON SET Kolben Set Set de Piston Pistón Set поршеньой	RINGS SET Kolben Set Segments de Piston Anillos Set кольца	PIN Pin Axe Perno Пин
<b>AR 32301</b> <b>AR 34103</b> <b>M 647 CA</b> 4 Cyl 83.0 mm Bore Ø 1,969 cc		Length: Outside Ø: Flange Ø: flange depth	Length: 56.0 Comp: 32.1 Height: -1.6 -4.1	skirt MOS2 treated	Top: 1.2 2nd: 1.5 3rd: 1st oil: 3.0 2nd oil:	Ø: 20.0 Length: 52.0
		Reference no.:	Reference no.:	Reference no.:	Reference no.:	O-RING
			<b>A-24100</b> <b>M-0635500</b> <b>N-8711090000</b>	<b>5 895 171</b> <b>5 896 126</b> <b>606 038 05</b> <b>606 038 06</b> <b>606 038 07</b>	<b>A-R60020</b> <b>G-0811090000</b> <b>M-06355N0</b>	
NM-Germany Article no. Artikelnummer/ Modelo Número / статья НОМЕР	NM-Germany Article no.	NM-Germany Article no.	NM-Germany Article no.	NM-Germany Article no.	NM-Germany Article no.	NM-Germany Article no.
			<b>KBSAR40008G</b>	<b>KBAR40008G</b>	<b>KRAR40008G</b>	

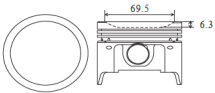
**GASOLINE**



ENGINE TYPE Motortyp Type de Moteur Tipo de motor Тип двигателя	LINER KIT Liner Kit Kit de Chemise Camisas de los cilindros лайнер комплект	CYL. LINER Zylinderlaufbuchse Chemise Camisas de los cilindros втулка цилиндра	PISTON + RINGS Kolben + Ringe Piston + Segments Pistón Set Поршень и кольца	PISTON SET Kolben Set Set de Piston Pistón Set поршеньой	RINGS SET Kolben Set Segments de Piston Anillos Set кольца	PIN Pin Axe Perno Пин
<b>301.24</b> <b>301.28</b> <b>301.98</b> 4 Cyl 84.0 mm Bore Ø 1,490 cc		Length: Outside Ø: Flange Ø: flange depth	Length: 67.5 Comp: 34.5 Height: -6.3		Top: 1.5 2nd: 1.75 3rd: 1st oil: 4.0 2nd oil:	Ø: 21.0 Length: 63.4
		Reference no.:	Reference no.:	Reference no.:	Reference no.:	O-RING
			<b>A-24157</b>		<b>A-R46470</b> <b>G-0810900010</b>	
NM-Germany Article no. Artikelnummer/ Modelo Número / статья НОМЕР	NM-Germany Article no.	NM-Germany Article no.	NM-Germany Article no.	NM-Germany Article no.	NM-Germany Article no.	NM-Germany Article no.
			<b>KBSAR40009G</b>	<b>KBAR40009G</b>	<b>KRAR40009G</b>	

ENGINE TYPE	LINER KIT	CYL. LINER	PISTON + RINGS			PISTON SET	RINGS SET	PIN
Motorotyp Type de Moteur Tipo de motor Тип двигателя	Liner Kit Kit de Chemise Camisas de los cilindros лайнер комплект	Zylinderlaufbuchse Chemise Camisas de los cilindros втулка цилиндра	Kolben + Ringe Piston + Segments Pistón Set Поршень и кольца			Kolben Set Set de Piston Pistón Set поршневой	Kolben Set Segments de Piston Anillos Set кольца	Pin Axe Perno Пин
<b>HR TURBO VM TURBO</b> 4 Cyl 92.0 mm Bore Ø 2,499 cc	<b>A-ASA2460 K-92286961 K-92286971 M-4891390 N-8911010000</b>	Length: 168.0	Length: 86.1			alfin head and top ring land anodized	Top: 2.5	Ø: 30.0
		Outside Ø: 103.0	Comp: 51.1				double key-stone	Length: 75.5
		Flange Ø: 110.0	Height: -2.3				2nd: 2.0	
		flange depth 8.9 +1.2		Height: -3.9			3rd: 4.0	
			Reference no.:	Reference no.:	Reference no.:	Reference no.:	O-RING	
			<b>A-SJ351453 G-1467642000 K-89500110 M-489WN01</b>	<b>K-92286600 K-92286700 M-4891300</b>		<b>A-R47730 G-0811010000 K-80000110000 M-48912N0</b>	<b>ORAR40010DA</b>	
NM-Germany Article no. Artikelnummer/ Modelo Número / статья НОМЕР	NM-Germany Article no.	NM-Germany Article no.	NM-Germany Article no.	NM-Germany Article no.	NM-Germany Article no.	NM-Germany Article no.	NM-Germany Article no.	
	<b>LBSAR40010DFA</b>	<b>LBAR40010DFA</b>	<b>KBSAR40010DA</b>	<b>KBAR40010DA</b>	<b>KBAR40010DA</b>	<b>KRAR40010DA</b>		

ENGINE TYPE	LINER KIT	CYL. LINER	PISTON + RINGS			PISTON SET	RINGS SET	PIN
Motorotyp Type de Moteur Tipo de motor Тип двигателя	Liner Kit Kit de Chemise Camisas de los cilindros лайнер комплект	Zylinderlaufbuchse Chemise Camisas de los cilindros втулка цилиндра	Kolben + Ringe Piston + Segments Pistón Set Поршень и кольца			Kolben Set Set de Piston Pistón Set поршневой	Kolben Set Segments de Piston Anillos Set кольца	Pin Axe Perno Пин
<b>RG</b> 4 Cyl 92.0 mm Bore Ø 2,499 cc	<b>M-0637390</b>	Length: 168.0	Length: 81.3			alfin and with oil gallery	Top: 2.5	Ø: 30.0
		Outside Ø: 103.0	Comp: 51.2				double key-stone	Length: 74.2
		Flange Ø: 110.0	Height: -0.8				2nd: 1.5	
		flange depth 8.9 +1.2		Height: -3.75			3rd: 2.0	
			Reference no.:	Reference no.:	Reference no.:	Reference no.:	O-RING	
			<b>A-SJ351453 G-1467642000 K-89500110 M-489WN01</b>	<b>M-0637300</b>		<b>A-R67370 G-0813410000</b>	<b>ORAR40011DB</b>	
NM-Germany Article no. Artikelnummer/ Modelo Número / статья НОМЕР	NM-Germany Article no.	NM-Germany Article no.	NM-Germany Article no.	NM-Germany Article no.	NM-Germany Article no.	NM-Germany Article no.	NM-Germany Article no.	
	<b>LBSAR40011DFB</b>	<b>LBAR40011DFB</b>	<b>KBSAR40011DB</b>	<b>KBAR40011DB</b>	<b>KBAR40011DB</b>	<b>KRAR40011DB</b>		

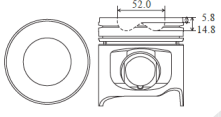

ENGINE TYPE	LINER KIT	CYL. LINER	PISTON + RINGS			PISTON SET	RINGS SET	PIN
Motorotyp Type de Moteur Tipo de motor Тип двигателя	Liner Kit Kit de Chemise Camisas de los cilindros лайнер комплект	Zylinderlaufbuchse Chemise Camisas de los cilindros втулка цилиндра	Kolben + Ringe Piston + Segments Pistón Set Поршень и кольца			Kolben Set Set de Piston Pistón Set поршневой	Kolben Set Segments de Piston Anillos Set кольца	Pin Axe Perno Пин
<b>8140.61</b> 4 Cyl 93.0 mm Bore Ø 2,445 cc	<b>(A) K-93378970 M-0079890 consists of (C)</b>  <b>(B) K-93378971 M-0079892 consists of (D)</b>	Length: 167.0	(C) 167.3	(D)		alfin head anodized	Top: 3.0	Ø: 32.0
		Outside Ø: 96.0	96.0	Comp: 54.7			2nd: 2.0	Length: 74.4
		Flange Ø: 98.9	98.9	Height: -2.0			3rd: 4.0	
		flange depth 5.0					1st oil: 4.0	
			Reference no.:	Reference no.:	Reference no.:	Reference no.:	O-RING	
			<b>(C) A-SU351407 K-89066190 M-007WV39</b>	<b>(D) G-1402256000 K-89183190 M-007WV43</b>	<b>A-A350663 K-93378700 M-0079800 N-8721450000</b>	<b>A-R47010 G-0821450010 K-800007040000 M-00798V0</b>		
NM-Germany Article no. Artikelnummer/ Modelo Número / статья НОМЕР	NM-Germany Article no.	NM-Germany Article no.	NM-Germany Article no.	NM-Germany Article no.	NM-Germany Article no.	NM-Germany Article no.	NM-Germany Article no.	
	<b>LBSAR40012DPA (A) LBSAR40012DSA (B)</b>	<b>LBAR40012DP (C) LBAR40012DS (D)</b>	<b>KBSAR40012DBA</b>	<b>KBAR40012DBA</b>	<b>KBAR40012DBA</b>	<b>KRAR40012DB</b>		

**DIESEL**



ENGINE TYPE Motortyp Type de Moteur Tipo de motor Тип двигателя	LINER KIT Liner Kit Kit de Chemise Camisas de los cilindros лайнер комплект	CYL. LINER Zylinderlaufbuchse Chemise Camisas de los cilindros втулка цилиндра	PISTON + RINGS Kolben + Ringe Piston + Segments Pistón Set Поршень и кольца	PISTON SET Kolben Set Set de Piston Pistón Set поршеньной	RINGS SET Kolben Set Segments de Piston Anillos Set кольца	PIN Pin Axe Perno Пин
<b>8140.21.200 TURBO</b> <b>8144.21.200 TURBO</b>	<b>K-93123960</b> <b>M-0080592</b>			alfin	Top: 3.0 double key-stone 2nd: 2.0 3rd: 3.0 1st oil: 2nd oil:	Ø: 32.0 Length: 75.2
<b>4 Cyl</b> <b>93.0 mm Bore Ø</b> <b>2,445 cc</b>		Length: 171.0 Outside Ø: 96.0 Flange Ø: 98.9 flange depth 5.0	Length: 97.65 Comp: 59.65 Height: -5.8 -14.8			
						
NM-Germany Article no. Artikelnummer/ Modelo Número / статья НОМЕР	NM-Germany Article no.	NM-Germany Article no.	NM-Germany Article no.	NM-Germany Article no.	NM-Germany Article no.	NM-Germany Article no.
	LBSAR40013DSA	LBAR40013DSA	KBSAR40013DA	KBAR40013DA	KRAR40013DA	

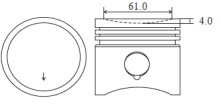



**GASOLINE**

ENGINE TYPE Motortyp Type de Moteur Tipo de motor Тип двигателя	LINER KIT Liner Kit Kit de Chemise Camisas de los cilindros лайнер комплект	CYL. LINER Zylinderlaufbuchse Chemise Camisas de los cilindros втулка цилиндра	PISTON + RINGS Kolben + Ringe Piston + Segments Pistón Set Поршень и кольца		PISTON SET Kolben Set Set de Piston Pistón Set поршневой	RINGS SET Kolben Set Segments de Piston Anillos Set кольца	PIN Pin Axe Perno Пин
<b>HB</b> <b>HD</b> 4 Cyl 69.5 mm Bore Ø 1,093 cc 				STD	O/S	Top: 1.75 2nd: 2.0 3rd: 1st oil: 4.0 2nd oil:	Ø: 20.0 Length: 58.0
			Length:	67.2	66.95		
			Outside Ø:	40.2	39.95		
		Flange Ø:		-4.0	-4.0		
		flange depth					
			Reference no.:	Reference no.:	Reference no.:	Reference no.:	O-RING
				<b>K-93159600</b> <b>M-0294400</b> <b>N-8710870000</b>		<b>G-0810870000</b> <b>K-800000240000</b> <b>M-02943N0</b>	
NM-Germany Article no. Artikelnummer/ Modelo Número / статья НОМЕР	NM-Germany Article no.	NM-Germany Article no.	NM-Germany Article no.	NM-Germany Article no.	NM-Germany Article no.	NM-Germany Article no.	NM-Germany Article no.
			<b>KBSAD40017G</b>	<b>KBAD40017G</b>	<b>KRAD40017G</b>		

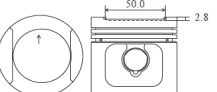

**GASOLINE**

ENGINE TYPE Motortyp Type de Moteur Tipo de motor Тип двигателя	LINER KIT Liner Kit Kit de Chemise Camisas de los cilindros лайнер комплект	CYL. LINER Zylinderlaufbuchse Chemise Camisas de los cilindros втулка цилиндра	PISTON + RINGS Kolben + Ringe Piston + Segments Pistón Set Поршень и кольца		PISTON SET Kolben Set Set de Piston Pistón Set поршневой	RINGS SET Kolben Set Segments de Piston Anillos Set кольца	PIN Pin Axe Perno Пин	
<b>FY</b> <b>FZ</b> <b>HH</b> 4 Cyl 75.0 mm Bore Ø 1,272 cc 	<b>M-0294890</b>			STD	O/S	Top: 1.75 2nd: 2.0 3rd: 1st oil: 4.0 2nd oil:	Ø: 20.0 Length: 63.0	
			Length:	133.0	65.6	65.3		
			Outside Ø:	78.0	38.6	38.3		
		Flange Ø:	81.0		+0	+0		
		flange depth	4.5					
			Reference no.:	Reference no.:	Reference no.:	Reference no.:	O-RING	
			<b>M-029WV19</b>	<b>K-93084600</b> <b>M-0294800</b>		<b>G-0840420000</b> <b>K-800000440000</b> <b>M-02948N0</b>		
NM-Germany Article no. Artikelnummer/ Modelo Número / статья НОМЕР	NM-Germany Article no.	NM-Germany Article no.	NM-Germany Article no.	NM-Germany Article no.	NM-Germany Article no.	NM-Germany Article no.	NM-Germany Article no.	
	<b>LBSAD40018GS</b>	<b>LBAD40018GS</b>	<b>KBSAD40018G</b>	<b>KBAD40018G</b>	<b>KRAD40018DG</b>			

**GASOLINE**

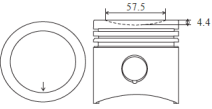

ENGINE TYPE Motortyp Type de Moteur Tipo de motor Тип двигателя	LINER KIT Liner Kit Kit de Chemise Camisas de los cilindros лайнер комплект	CYL. LINER Zylinderlaufbuchse Chemise Camisas de los cilindros втулка цилиндра	PISTON + RINGS Kolben + Ringe Piston + Segments Pistón Set Поршень и кольца		PISTON SET Kolben Set Set de Piston Pistón Set поршневой	RINGS SET Kolben Set Segments de Piston Anillos Set кольца	PIN Pin Axe Perno Пин
<b>EP</b> 4 Cyl 75.0 mm Bore Ø 1,297 cc 						Top: 1.5 2nd: 1.75 3rd: 1st oil: 3.0 2nd oil:	Ø: 20.0 Length: 57.0
			Length:	71.8			
			Outside Ø:	39.8			
		Flange Ø:		-2.8			
		flange depth					
			Reference no.:	Reference no.:	Reference no.:	Reference no.:	O-RING
				<b>K-93892600</b> <b>M-0341900</b>		<b>G-0840870000</b> <b>K-800000340000</b> <b>M-03419N0</b>	
NM-Germany Article no. Artikelnummer/ Modelo Número / статья НОМЕР	NM-Germany Article no.	NM-Germany Article no.	NM-Germany Article no.	NM-Germany Article no.	NM-Germany Article no.	NM-Germany Article no.	NM-Germany Article no.
			<b>KBSAD40019G</b>	<b>KBAD40019G</b>	<b>KRAD40019G</b>		

**GASOLINE**

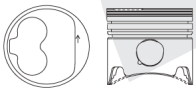

ENGINE TYPE Motortyp Type de Moteur Tipo de motor Тип двигателя	LINER KIT Liner Kit Kit de Chemise Camisas de los cilindros лайнер комплект	CYL. LINER Zylinderlaufbuchse Chemise Camisas de los cilindros втулка цилиндра	PISTON + RINGS Kolben + Ringe Piston + Segments Pistón Set Поршень и кольца		PISTON SET Kolben Set Set de Piston Pistón Set поршневой	RINGS SET Kolben Set Segments de Piston Anillos Set кольца	PIN Pin Axe Perno Пин
<b>EP ZA ZF</b> 4 Cyl 75.0 mm Bore Ø 1,297 cc  		Length: Outside Ø: Flange Ø: flange depth	STD	O/S		Top: 2.0 2nd: 2.5 3rd: 1st oil: 4.0 2nd oil: Length: 62.7	Ø: 22.0  Length: 62.7
			Length: 77.5	77.2			
			Comp: 45.5	45.2			
Reference no.:		Reference no.:		Reference no.:	Reference no.:	O-RING	
		<b>K-92243600 M-0341800</b>			<b>G-0810880000 K-800000540000 M-03418N0</b>		
NM-Germany Article no. Artikelnummer/ Modelo Número / статья НОМЕР	NM-Germany Article no.	NM-Germany Article no.	NM-Germany Article no.	NM-Germany Article no.	NM-Germany Article no.	NM-Germany Article no.	
			<b>KBSAD40020G</b>	<b>KBAD40020DG</b>	<b>KRAD40020DG</b>		

AUDI



**DIESEL**

ENGINE TYPE Motortyp Type de Moteur Tipo de motor Тип двигателя	LINER KIT Liner Kit Kit de Chemise Camisas de los cilindros лайнер комплект	CYL. LINER Zylinderlaufbuchse Chemise Camisas de los cilindros втулка цилиндра	PISTON + RINGS Kolben + Ringe Piston + Segments Pistón Set Поршень и кольца		PISTON SET Kolben Set Set de Piston Pistón Set поршневой	RINGS SET Kolben Set Segments de Piston Anillos Set кольца	PIN Pin Axe Perno Пин
<b>CY/DE TURBO NC RA/SB TURBO</b> 4/5 Cyl 76.5 mm Bore Ø 1,588 cc 1,986 cc  	<b>K-90732960 M-0297990</b>	Length: 145.0 Outside Ø: 79.5 Flange Ø: 81.5 flange depth 4.7	STD	O/S	alfin head anodized fits tapered con. rod	Top: 1.75 2nd: 2.0 3rd: 1st oil: 3.0 2nd oil: Length: 64.0	Ø: 24.0  Length: 64.0
			Length: 71.7	71.45			
			Comp: 41.7	41.45			
Reference no.:		Reference no.:		Reference no.:	Reference no.:	O-RING	
		<b>G-140283600 K-89163190 M-029WV13</b>		<b>K-90732600 M-0297900 N-8710980010</b>	<b>A-R43850 A-R45270 G-0810950000 G-0810980000 K-800000610000 M-02954/55N0</b>		
NM-Germany Article no. Artikelnummer/ Modelo Número / статья НОМЕР	NM-Germany Article no.	NM-Germany Article no.	NM-Germany Article no.	NM-Germany Article no.	NM-Germany Article no.	NM-Germany Article no.	
	<b>LBSAD450021DSA</b>	<b>LBAD450021DSA</b>	<b>KBSAD450021DA</b>	<b>KBAD450021DA</b>	<b>KRAD450021DA</b>		

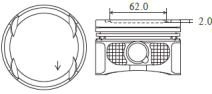

**DIESEL**

ENGINE TYPE Motortyp Type de Moteur Tipo de motor Тип двигателя	LINER KIT Liner Kit Kit de Chemise Camisas de los cilindros лайнер комплект	CYL. LINER Zylinderlaufbuchse Chemise Camisas de los cilindros втулка цилиндра	PISTON + RINGS Kolben + Ringe Piston + Segments Pistón Set Поршень и кольца		PISTON SET Kolben Set Set de Piston Pistón Set поршневой	RINGS SET Kolben Set Segments de Piston Anillos Set кольца	PIN Pin Axe Perno Пин
<b>CN/CR CY/JK</b> 4/5 Cyl 76.5 mm Bore Ø 1,588 cc 1,986 cc  	<b>K-93260960 M-0295590</b>	Length: 145.0 Outside Ø: 79.5 Flange Ø: 81.5 flange depth 4.7	Length: 71.7		alfin	Top: 1.75 2nd: 2.0 3rd: 1st oil: 3.0 2nd oil: Length: 64.0	Ø: 24.0  Length: 64.0
			Comp: 41.7				
			Height: -1.6				
Reference no.:		Reference no.:		Reference no.:	Reference no.:	O-RING	
		<b>G-140283600 K-89163190 M-029WV13</b>		<b>K-93260600 M-0295500 N-8710950000</b>	<b>A-R43850 A-R45270 G-0810950000 G-0810980000 K-800000610000 M-02954/55N0</b>		
NM-Germany Article no. Artikelnummer/ Modelo Número / статья НОМЕР	NM-Germany Article no.	NM-Germany Article no.	NM-Germany Article no.	NM-Germany Article no.	NM-Germany Article no.	NM-Germany Article no.	
	<b>LBSAD450022DSA</b>	<b>LBAD450022DSA</b>	<b>KBSAD450022DA</b>	<b>KBAD450022DA</b>	<b>KRAD450022DA</b>		

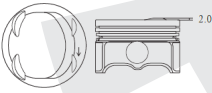

## GASOLINE

ENGINE TYPE Motortyp Type de Moteur Tipo de motor Тип двигателя	LINER KIT Liner Kit Kit de Chemise Camisas de los cilindros лайнер комплект	CYL. LINER Zylinderlaufbuchse Chemise Camisas de los cilindros втулка цилиндра	PISTON + RINGS Kolben + Ringe Piston + Segments Pistón Set Поршень и кольца		PISTON SET Kolben Set Set de Piston Pistón Set поршневой	RINGS SET Kolben Set Segments de Piston Anillos Set кольца	PIN Pin Axe Perno Пин
<b>AUA</b> 4 Cyl 76.5 mm Bore Ø 1,390 cc 		Length: Outside Ø: Flange Ø: flange depth	STD	O/S	skirt MOS2 treated	Top: 1.2	Ø: 17.0 Length: 54.0
			Length: 50.0	49.75		2nd: 1.5	
			Comp: 29.0	28.75		3rd: 2.5	
Reference no.:		Reference no.:		Reference no.:	Reference no.:	O-RING	
		<b>K-99562600</b> <b>M-0306100</b> <b>N-8711610000</b>			<b>A-R60280</b> <b>G-0850280000</b> <b>K-800026140000</b> <b>M-03032N0</b>		
NM-Germany Article no. Artikelnummer/ Modelo Número / статья НОМЕР	NM-Germany Article no.	NM-Germany Article no.	NM-Germany Article no.	NM-Germany Article no.	NM-Germany Article no.	NM-Germany Article no.	NM-Germany Article no.
			<b>KBSAD40023DG</b>	<b>KBAD40023G</b>	<b>KRAD40023DG</b>		

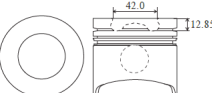

## GASOLINE

ENGINE TYPE Motortyp Type de Moteur Tipo de motor Тип двигателя	LINER KIT Liner Kit Kit de Chemise Camisas de los cilindros лайнер комплект	CYL. LINER Zylinderlaufbuchse Chemise Camisas de los cilindros втулка цилиндра	PISTON + RINGS Kolben + Ringe Piston + Segments Pistón Set Поршень и кольца		PISTON SET Kolben Set Set de Piston Pistón Set поршневой	RINGS SET Kolben Set Segments de Piston Anillos Set кольца	PIN Pin Axe Perno Пин
<b>CAXC</b> <b>CMSA</b> 4 Cyl 76.5 mm Bore Ø 1,390 cc 		Length: Outside Ø: Flange Ø: flange depth	Length: 50.21			Top: 1.2	Ø: 19.0 Length: 52.0
			Comp: 29.22			2nd: 1.2	
			Height: 2.0			3rd: 2.0	
Reference no.:		Reference no.:		Reference no.:	Reference no.:	O-RING	
		<b>K-40477600</b>		<b>03C 107 065 AP</b>	<b>K-800073340000</b>		
NM-Germany Article no. Artikelnummer/ Modelo Número / статья НОМЕР	NM-Germany Article no.	NM-Germany Article no.	NM-Germany Article no.	NM-Germany Article no.	NM-Germany Article no.	NM-Germany Article no.	NM-Germany Article no.
			<b>KBSAD40024G</b>	<b>KBAD40024G</b>	<b>KRAD40024G</b>		



## DIESEL

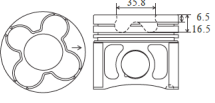

ENGINE TYPE Motortyp Type de Moteur Tipo de motor Тип двигателя	LINER KIT Liner Kit Kit de Chemise Camisas de los cilindros лайнер комплект	CYL. LINER Zylinderlaufbuchse Chemise Camisas de los cilindros втулка цилиндра	PISTON + RINGS Kolben + Ringe Piston + Segments Pistón Set Поршень и кольца		PISTON SET Kolben Set Set de Piston Pistón Set поршневой	RINGS SET Kolben Set Segments de Piston Anillos Set кольца	PIN Pin Axe Perno Пин
<b>AKF TURBO</b> 8 Cyl 78.3 mm Bore Ø 3,328 cc 		Length: Outside Ø: Flange Ø: flange depth	Length: 71.8		alfin and with oil gallery skirt MOS2 treated fits tapered con. rod	Top: 2.0	Ø: 26.0 Length: 58.0
			Comp: 47.8			double key- stone	
			Height: -12.85			2nd: 2.0	
Reference no.:		Reference no.:		Reference no.:	Reference no.:	O-RING	
		<b>M-0331500</b>			<b>M-03315N0</b>		
NM-Germany Article no. Artikelnummer/ Modelo Número / статья НОМЕР	NM-Germany Article no.	NM-Germany Article no.	NM-Germany Article no.	NM-Germany Article no.	NM-Germany Article no.	NM-Germany Article no.	NM-Germany Article no.
			<b>KBSAD80025DB</b>	<b>KBAD80025DB</b>	<b>KRAD80025DB</b>		

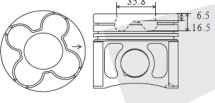

ENGINE TYPE Motortyp Type de Moteur Tipo de motor Тип двигателя	LINER KIT Liner Kit Kit de Chemise Camisas de los cilindros лайнер комплект	CYL. LINER Zylinderlaufbuchse Chemise Camisas de los cilindros втулка цилиндра	PISTON + RINGS Kolben + Ringe Piston + Segments Pistón Set Поршень и кольца		PISTON SET Kolben Set Set de Piston Pistón Set поршневой	RINGS SET Kolben Set Segments de Piston Anillos Set кольца	PIN Pin Axe Perno Пин
<b>AFB TURBO AKN TURBO</b> 6 Cyl 78.3 mm Bore Ø 2,496 cc  		Length: 155.0 Outside Ø: 82.0 Flange Ø: 84.0 flange depth 3.0	STD	O/S	alfin and with oil gallery skirt MOS2 treated	Top: 1.75 2nd: 2.0 3rd: 3.0 1st oil: 2nd oil:	Ø: 26.0 Length: 65.5
			Length: 71.83	71.58			
			Comp: 47.83	47.58			
Reference no.:		Reference no.:		Reference no.:	Reference no.:	O-RING	
		K-99776600 M-0334000			A-R66900 G-0810300000 K-800051540000 M-03340V0		
NM-Germany Article no. Artikelnummer/ Modelo Número / статья НОМЕР	NM-Germany Article no.	NM-Germany Article no.	NM-Germany Article no.	NM-Germany Article no.	NM-Germany Article no.	NM-Germany Article no.	
	LBSAD60026DSB (for cyl 1/2/3)	LBAD60026DSB	KBSAD60026DB (for cyl 1/2/3)	KBAD60026DB (for cyl 1/2/3)	KRAD60026DB		

AUDI

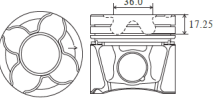
DIESEL							
ENGINE TYPE Motortyp Type de Moteur Tipo de motor Тип двигателя	LINER KIT Liner Kit Kit de Chemise Camisas de los cilindros лайнер комплект	CYL. LINER Zylinderlaufbuchse Chemise Camisas de los cilindros втулка цилиндра	PISTON + RINGS Kolben + Ringe Piston + Segments Pistón Set Поршень и кольца		PISTON SET Kolben Set Set de Piston Pistón Set поршневой	RINGS SET Kolben Set Segments de Piston Anillos Set кольца	PIN Pin Axe Perno Пин
<b>AFB TURBO AKN TURBO</b> 6 Cyl 78.3 mm Bore Ø 2,496 cc  		Length: 155.0 Outside Ø: 82.0 Flange Ø: 84.0 flange depth 3.0	STD	O/S	alfin and with oil gallery skirt MOS2 treated	Top: 1.75 2nd: 2.0 3rd: 3.0 1st oil: 2nd oil:	Ø: 26.0 Length: 65.5
			Length: 71.83	71.58			
			Comp: 47.83	47.58			
Reference no.:		Reference no.:		Reference no.:	Reference no.:	O-RING	
		K-99777600 M-0334100			A-R66900 G-0810300000 K-800051540000 M-03340V0		
NM-Germany Article no. Artikelnummer/ Modelo Número / статья НОМЕР	NM-Germany Article no.	NM-Germany Article no.	NM-Germany Article no.	NM-Germany Article no.	NM-Germany Article no.	NM-Germany Article no.	
	LBSAD60027DSB (for cyl 4/5/6)	LBAD60027DSB	KBSAD60027DB (for cyl 4/5/6)	KBAD60027DB (for cyl 4/5/6)	KRAD60027DB		

DIESEL							
ENGINE TYPE Motortyp Type de Moteur Tipo de motor Тип двигателя	LINER KIT Liner Kit Kit de Chemise Camisas de los cilindros лайнер комплект	CYL. LINER Zylinderlaufbuchse Chemise Camisas de los cilindros втулка цилиндра	PISTON + RINGS Kolben + Ringe Piston + Segments Pistón Set Поршень и кольца		PISTON SET Kolben Set Set de Piston Pistón Set поршневой	RINGS SET Kolben Set Segments de Piston Anillos Set кольца	PIN Pin Axe Perno Пин
<b>AKE/AYM TURBO BAU/BCZ/BFC TURBO</b> 6 Cyl 78.3 mm Bore Ø 2,496 cc  		Length: 155.0 Outside Ø: 82.0 Flange Ø: 84.0 flange depth 3.0	STD	O/S	alfin and with oil gallery skirt MOS2 treated fits tapered con. rod	Top: 1.75 2nd: 2.0 3rd: 3.0 1st oil: 2nd oil:	Ø: 26.0 Length: 58.0
			Length: 71.83	71.83			
			Comp: 47.83	47.58			
Reference no.:		Reference no.:		Reference no.:	Reference no.:	O-RING	
		K-99534600 M-0334200			A-R66900 G-0810300000 K-800051540000 M-03340V0		
NM-Germany Article no. Artikelnummer/ Modelo Número / статья НОМЕР	NM-Germany Article no.	NM-Germany Article no.	NM-Germany Article no.	NM-Germany Article no.	NM-Germany Article no.	NM-Germany Article no.	
	LBSAD60028DSB (for cyl 1/2/3)	LBAD60028DSB	KBSAD60028DB (for cyl 1/2/3)	KBAD60028DB (for cyl 1/2/3)	KRAD60028DB		

## DIESEL

ENGINE TYPE Motortyp Type de Moteur Tipo de motor Тип двигателя	LINER KIT Liner Kit Kit de Chemise Camisas de los cilindros лайнер комплект	CYL. LINER Zylinderlaufbuchse Chemise Camisas de los cilindros втулка цилиндра	PISTON + RINGS Kolben + Ringe Piston + Segments Pistón Set Поршень и кольца		PISTON SET Kolben Set Set de Piston Pistón Set поршень	RINGS SET Kolben Set Segments de Piston Anillos Set кольца	PIN Pin Axe Perno Пин	
<b>AKE/AYM TURBO</b> <b>BAU/BCZ/BFC TURBO</b> <b>6 Cyl</b> <b>78.3 mm Bore Ø</b> <b>2,496 cc</b>		Length: 155.0 Outside Ø: 82.0 Flange Ø: 84.0 flange depth 3.0	STD	O/S	alfin and with oil gallery skirt MOS2 treated fits tapered con. rod	Top: 1.75 2nd: 2.0 3rd: 3.0 1st oil: 3.0 2nd oil:	Ø: 26.0 Length: 58.0	
			Length: 71.83	71.83		Length: 47.83		47.58
			Comp: 47.83	47.58		Height: -1.38		-1.38
Reference no.:		Reference no.:		Reference no.:	Reference no.:	O-RING		
				<b>K-99535600</b> <b>M-0334300</b>		<b>A-R66900</b> <b>G-0810300000</b> <b>K-800051540000</b> <b>M-03340V0</b>		
NM-Germany Article no. Artikelnummer/ Modelo Número / статья НОМЕР	NM-Germany Article no.	NM-Germany Article no.	NM-Germany Article no.	NM-Germany Article no.	NM-Germany Article no.	NM-Germany Article no.	NM-Germany Article no.	
	<b>LBSAD60029DSB</b> (for cyl 4/5/6)	<b>LBAD60029DSB</b>	<b>KBSAD60029DB</b> (for cyl 4/5/6)	<b>KBAD60029DB</b> (for cyl 4/5/6)	<b>KRAD60029DB</b>			

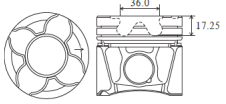

## DIESEL

ENGINE TYPE Motortyp Type de Moteur Tipo de motor Тип двигателя	LINER KIT Liner Kit Kit de Chemise Camisas de los cilindros лайнер комплект	CYL. LINER Zylinderlaufbuchse Chemise Camisas de los cilindros втулка цилиндра	PISTON + RINGS Kolben + Ringe Piston + Segments Pistón Set Поршень и кольца		PISTON SET Kolben Set Set de Piston Pistón Set поршень	RINGS SET Kolben Set Segments de Piston Anillos Set кольца	PIN Pin Axe Perno Пин	
<b>BDG TURBO</b> <b>BDH TURBO</b> <b>6 Cyl</b> <b>78.3 mm Bore Ø</b> <b>2,496 cc</b>	<b>K-99542600</b> <b>A-R66900</b> <b>G-0810300000</b> <b>K-800051540000</b> <b>M-03340V0</b>	Length: 155.0 Outside Ø: 82.0 Flange Ø: 84.0 flange depth 3.0	STD	O/S	alfin and with oil gallery skirt MOS2 treated fits tapered con. rod	Top: 1.75 2nd: 2.0 3rd: 3.0 1st oil: 3.0 2nd oil:	Ø: 26.0 Length: 58.0	
			Length: 71.83	71.58		Length: 47.83		47.58
			Comp: 47.83	47.58		Height: -1.38		-1.38
Reference no.:		Reference no.:		Reference no.:	Reference no.:	O-RING		
NM-Germany Article no. Artikelnummer/ Modelo Número / статья НОМЕР	NM-Germany Article no.	NM-Germany Article no.	NM-Germany Article no.	NM-Germany Article no.	NM-Germany Article no.	NM-Germany Article no.	NM-Germany Article no.	
	<b>LBSAD60030DSB</b> (for cyl 1/2/3)	<b>LBAD60030DSB</b>	<b>KBSAD60030DB</b> (for cyl 1/2/3)	<b>KBAD60030DB</b> (for cyl 1/2/3)	<b>KRAD60030DB</b>			

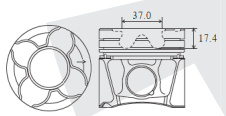

## DIESEL

ENGINE TYPE Motortyp Type de Moteur Tipo de motor Тип двигателя	LINER KIT Liner Kit Kit de Chemise Camisas de los cilindros лайнер комплект	CYL. LINER Zylinderlaufbuchse Chemise Camisas de los cilindros втулка цилиндра	PISTON + RINGS Kolben + Ringe Piston + Segments Pistón Set Поршень и кольца		PISTON SET Kolben Set Set de Piston Pistón Set поршень	RINGS SET Kolben Set Segments de Piston Anillos Set кольца	PIN Pin Axe Perno Пин	
<b>BDG TURBO</b> <b>BDH TURBO</b> <b>6 Cyl</b> <b>78.3 mm Bore Ø</b> <b>2,496 cc</b>	<b>K-99543600</b> <b>A-R66900</b> <b>G-0810300000</b> <b>K-800051540000</b> <b>M-03340V0</b>	Length: 155.0 Outside Ø: 82.0 Flange Ø: 84.0 flange depth 3.0	STD	O/S	alfin and with oil gallery skirt MOS2 treated fits tapered con. rod	Top: 1.75 2nd: 2.0 3rd: 3.0 1st oil: 3.0 2nd oil:	Ø: 26.0 Length: 58.0	
			Length: 71.83	71.58		Length: 47.83		47.58
			Comp: 47.83	47.58		Height: -1.38		-1.38
Reference no.:		Reference no.:		Reference no.:	Reference no.:	O-RING		
NM-Germany Article no. Artikelnummer/ Modelo Número / статья НОМЕР	NM-Germany Article no.	NM-Germany Article no.	NM-Germany Article no.	NM-Germany Article no.	NM-Germany Article no.	NM-Germany Article no.	NM-Germany Article no.	
	<b>LBSAD60031DSB</b> (for cyl 4/5/6)	<b>LBAD60031DSB</b>	<b>KBSAD60031DB</b> (for cyl 4/5/6)	<b>KBAD60031DB</b> (for cyl 4/5/6)	<b>KRAD60031DB</b>			

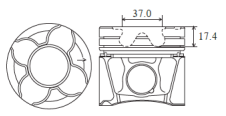

**DIESEL**

ENGINE TYPE Motortyp Type de Moteur Tipo de motor Тип двигателя	LINER KIT Liner Kit Kit de Chemise Camisas de los cilindros лайнер комплект	CYL. LINER Zylinderlaufbuchse Chemise Camisas de los cilindros втулка цилиндра	PISTON + RINGS Kolben + Ringe Piston + Segments Pistón Set Поршень и кольца		PISTON SET Kolben Set Set de Piston Pistón Set поршневой	RINGS SET Kolben Set Segments de Piston Anillos Set кольца	PIN Pin Axe Perno Пин
<b>1Z/AFN/AGR TURBO</b> <b>AHF/ALH/ASV TURBO</b>  <b>4 Cyl</b> <b>79.5 mm Bore Ø</b> <b>1,896 cc</b>	<b>K-94427970</b>			STD 0.50 0.25 1.00	alfin top ring land and skirt MOS2 treated pin bushing inserted	Top: 1.75 2nd: 2.0 3rd: 3.0 1st oil: 2nd oil: 3.0	Ø: 26.0 Length: 66.0
		Length: 152.0 Outside Ø: 82.5 Flange Ø: 85.5 flange depth 4.7	Length: 71.8 71.8 Comp: 45.8 45.55 Height: -8.8 -8.8 -17.75 -17.75				
		<b>Reference no.:</b>	<b>Reference no.:</b>	<b>Reference no.:</b>		<b>Reference no.:</b>	
		<b>A-SU351317</b> <b>G-1402795000</b> <b>K-89434190</b> <b>M-029WV20</b>	<b>K-94427700</b> <b>M-0304000</b> <b>N-8711490095</b>		<b>A-R60370</b> <b>G-0811490000</b> <b>K-800000810000</b> <b>K-800051640000</b> <b>M-03020N0</b>		
NM-Germany Article no. Artikelnummer/ Modelo Número / статья НОМЕР	NM-Germany Article no.	NM-Germany Article no.	NM-Germany Article no.	NM-Germany Article no.	NM-Germany Article no.	NM-Germany Article no.	NM-Germany Article no.
	<b>LBSAD40032DSA</b> (for cyl 1/2)	<b>LBAD40032DSA</b>	<b>KBSAD40032DA</b> (for cyl 1/2)	<b>KBAD40032DA</b> (for cyl 1/2)	<b>KRAD40032DA</b>		

AUDI

**DIESEL**

ENGINE TYPE Motortyp Type de Moteur Tipo de motor Тип двигателя	LINER KIT Liner Kit Kit de Chemise Camisas de los cilindros лайнер комплект	CYL. LINER Zylinderlaufbuchse Chemise Camisas de los cilindros втулка цилиндра	PISTON + RINGS Kolben + Ringe Piston + Segments Pistón Set Поршень и кольца		PISTON SET Kolben Set Set de Piston Pistón Set поршневой	RINGS SET Kolben Set Segments de Piston Anillos Set кольца	PIN Pin Axe Perno Пин
<b>1Z/AFN/AGR TURBO</b> <b>AHF/ALH/ASV TURBO</b>  <b>4 Cyl</b> <b>79.5 mm Bore Ø</b> <b>1,896 cc</b>	<b>K-94428970</b>			STD 0.50 0.25 1.00	alfin top ring land and skirt MOS2 treated pin bushing inserted	Top: 1.75 2nd: 2.0 3rd: 3.0 1st oil: 2nd oil: 3.0	Ø: 26.0 Length: 66.0
		Length: 152.0 Outside Ø: 82.5 Flange Ø: 85.5 flange depth 4.7	Length: 71.8 71.8 Comp: 45.8 45.55 Height: -8.8 -8.8 -17.75 -17.75				
		<b>Reference no.:</b>	<b>Reference no.:</b>	<b>Reference no.:</b>		<b>Reference no.:</b>	
		<b>A-SU351317</b> <b>G-1402795000</b> <b>K-89434190</b> <b>M-029WV20</b>	<b>K-94428700</b> <b>M-0304100</b> <b>N-8711490090</b>		<b>A-R60370</b> <b>G-0811490000</b> <b>K-800000810000</b> <b>K-800051640000</b> <b>M-03020N0</b>		
NM-Germany Article no. Artikelnummer/ Modelo Número / статья НОМЕР	NM-Germany Article no.	NM-Germany Article no.	NM-Germany Article no.	NM-Germany Article no.	NM-Germany Article no.	NM-Germany Article no.	NM-Germany Article no.
	<b>LBSAD40033DSA</b> (for cyl 3/4)	<b>LBAD40033DSA</b>	<b>KBSAD40033DA</b> (for cyl 3/4)	<b>KBAD40033DA</b> (for cyl 3/4)	<b>KRAD40033DA</b>		

**DIESEL**

ENGINE TYPE Motortyp Type de Moteur Tipo de motor Тип двигателя	LINER KIT Liner Kit Kit de Chemise Camisas de los cilindros лайнер комплект	CYL. LINER Zylinderlaufbuchse Chemise Camisas de los cilindros втулка цилиндра	PISTON + RINGS Kolben + Ringe Piston + Segments Pistón Set Поршень и кольца		PISTON SET Kolben Set Set de Piston Pistón Set поршневой	RINGS SET Kolben Set Segments de Piston Anillos Set кольца	PIN Pin Axe Perno Пин
<b>1Y</b> <b>3D/AAS</b>  <b>4/5 Cyl</b> <b>79.5 mm Bore Ø</b> <b>1,896 cc 2,370 cc</b>	<b>K-91386960</b> <b>M-0298290</b>			STD 0.50 0.25 1.00	alfin	Top: 1.75 2nd: 2.0 3rd: 3.0 1st oil: 2nd oil: 3.0	Ø: 24.0 Length: 64.0
		Length: 152.0 Outside Ø: 82.5 Flange Ø: 85.5 flange depth 4.7	Length: 65.7 65.7 Comp: 39.65 39.4 Height: -1.9 -1.9				
		<b>Reference no.:</b>	<b>Reference no.:</b>	<b>Reference no.:</b>		<b>Reference no.:</b>	
		<b>A-SU351317</b> <b>G-1402795000</b> <b>K-89434190</b> <b>M-029WV20</b>	<b>K-91386600</b> <b>M-0298200</b> <b>N-8799010040</b>		<b>A-R60370</b> <b>G-0811490000</b> <b>K-800000810000</b> <b>K-800051640000</b> <b>M-03020N0</b>		
NM-Germany Article no. Artikelnummer/ Modelo Número / статья НОМЕР	NM-Germany Article no.	NM-Germany Article no.	NM-Germany Article no.	NM-Germany Article no.	NM-Germany Article no.	NM-Germany Article no.	NM-Germany Article no.
	<b>LBSAD450034DSA</b>	<b>LBAD450034DSA</b>	<b>KBSAD450034DA</b>	<b>KBAD450034DA</b>	<b>KRAD450034DA</b>		

## DIESEL

ENGINE TYPE Motortyp Type de Moteur Tipo de motor Тип двигателя	LINER KIT Liner Kit Kit de Chemise Camisas de los cilindros лайнер комплект	CYL. LINER Zylinderlaufbuchse Chemise Camisas de los cilindros втулка цилиндра	PISTON + RINGS Kolben + Ringe Piston + Segments Pistón Set Поршень и кольца		PISTON SET Kolben Set Set de Piston Pistón Set поршень	RINGS SET Kolben Set Segments de Piston Anillos Set кольца	PIN Pin Axe Perno Пин
<b>AAZ TURBO</b> 4 Cyl 79.5 mm Bore Ø 1,896 cc	<b>K-91429960</b> <b>M-0299690</b>	Length: 152.0 Outside Ø: 82.5 Flange Ø: 85.5 flange depth 4.7	STD	0.50	alfin head anodized skirt MOS2 treated	Top: 1.75 2nd: 2.0 3rd: 3.0 1st oil: 2nd oil:	Ø: 26.0 Length: 66.0
			0.25	1.00			
			Length: 71.65	71.65			
		Comp: 45.65	45.4				
		Height: -1.9	-1.9				
		Reference no.:		Reference no.:	Reference no.:	Reference no.:	O-RING
		<b>A-SU351317</b> <b>G-1402795000</b> <b>K-89434190</b> <b>M-029WV20</b>		<b>K-91429600</b> <b>M-0299600</b> <b>N-8799010010</b>	<b>A-R60370</b> <b>G-0811490000</b> <b>K-800000810000</b> <b>K-800051640000</b> <b>M-03020N0</b>		
NM-Germany Article no. Artikelnummer/ Modelo Número / статья НОМЕР		NM-Germany Article no.		NM-Germany Article no.	NM-Germany Article no.	NM-Germany Article no.	NM-Germany Article no.
		<b>LBSAD40035DSA</b>		<b>LBAD40035DSA</b>	<b>KBSAD40035DA</b>	<b>KBAD40035DA</b>	<b>KRAD40035DA</b>

## DIESEL



ENGINE TYPE Motortyp Type de Moteur Tipo de motor Тип двигателя	LINER KIT Liner Kit Kit de Chemise Camisas de los cilindros лайнер комплект	CYL. LINER Zylinderlaufbuchse Chemise Camisas de los cilindros втулка цилиндра	PISTON + RINGS Kolben + Ringe Piston + Segments Pistón Set Поршень и кольца		PISTON SET Kolben Set Set de Piston Pistón Set поршень	RINGS SET Kolben Set Segments de Piston Anillos Set кольца	PIN Pin Axe Perno Пин
<b>ASZ TURBO</b> <b>AVF TURBO</b> <b>AWX TURBO</b> 4 Cyl 79.5 mm Bore Ø 1,896 cc		Length: 152.0 Outside Ø: 82.5 Flange Ø: 85.5 flange depth 4.7	STD	O/S	alfin and with oil gallery skirt MOS2 treated pin bushing inserted fits tapered con. rod	Top: 1.75 2nd: 2.0 3rd: 3.0 1st oil: 2nd oil:	Ø: 26.0 Length: 66.0
			69.8	69.55			
			Length: 69.8	69.55			
		Comp: 45.8	45.55				
		Height: -10.3	-10.3				
		Height: -17.5	-17.5				
		Reference no.:		Reference no.:	Reference no.:	Reference no.:	O-RING
		<b>A-SU351317</b> <b>G-1402795000</b> <b>K-89434190</b> <b>M-029WV20</b>		<b>K-99470600</b> <b>M-0308600</b> <b>N-8711490045</b>	<b>A-R60370</b> <b>G-0811490000</b> <b>K-800000810000</b> <b>K-800051640000</b> <b>M-03020N0</b>		
NM-Germany Article no. Artikelnummer/ Modelo Número / статья НОМЕР		NM-Germany Article no.		NM-Germany Article no.	NM-Germany Article no.	NM-Germany Article no.	NM-Germany Article no.
		<b>LBSAD40036DSB</b> (for cyl 1/2)		<b>LBAD40036DSB</b>	<b>KBSAD40036DB</b> (for cyl 1/2)	<b>KBAD40036DB</b> (for cyl 1/2)	<b>KRAD40036DB</b>

## DIESEL



ENGINE TYPE Motortyp Type de Moteur Tipo de motor Тип двигателя	LINER KIT Liner Kit Kit de Chemise Camisas de los cilindros лайнер комплект	CYL. LINER Zylinderlaufbuchse Chemise Camisas de los cilindros втулка цилиндра	PISTON + RINGS Kolben + Ringe Piston + Segments Pistón Set Поршень и кольца		PISTON SET Kolben Set Set de Piston Pistón Set поршень	RINGS SET Kolben Set Segments de Piston Anillos Set кольца	PIN Pin Axe Perno Пин
<b>ASZ TURBO</b> <b>AVF TURBO</b> <b>AWX TURBO</b> 4 Cyl 79.5 mm Bore Ø 1,896 cc		Length: 152.0 Outside Ø: 82.5 Flange Ø: 85.5 flange depth 4.7	STD	O/S	alfin and with oil gallery skirt MOS2 treated pin bushing inserted fits tapered con. rod	Top: 1.75 2nd: 2.0 3rd: 3.0 1st oil: 2nd oil:	Ø: 26.0 Length: 66.0
			69.8	69.55			
			Length: 69.8	69.55			
		Comp: 45.8	45.55				
		Height: -10.3	-10.3				
		Height: -17.5	-17.5				
		Reference no.:		Reference no.:	Reference no.:	Reference no.:	O-RING
		<b>A-SU351317</b> <b>G-1402795000</b> <b>K-89434190</b> <b>M-029WV20</b>		<b>K-99471600</b> <b>M-0308700</b> <b>N-8711490046</b>	<b>A-R60370</b> <b>G-0811490000</b> <b>K-800000810000</b> <b>K-800051640000</b> <b>M-03020N0</b>		
NM-Germany Article no. Artikelnummer/ Modelo Número / статья НОМЕР		NM-Germany Article no.		NM-Germany Article no.	NM-Germany Article no.	NM-Germany Article no.	NM-Germany Article no.
		<b>LBSAD40037DSB</b> (for cyl 3/4)		<b>LBAD40037DSB</b>	<b>KBSAD40037DB</b> (for cyl 3/4)	<b>KBAD40037DB</b> (for cyl 3/4)	<b>KRAD40037DB</b>

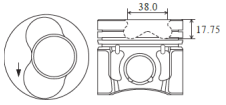

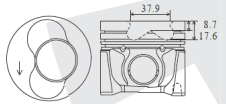

## DIESEL

ENGINE TYPE Motortyp Type de Moteur Tipo de motor Тип двигателя	LINER KIT Liner Kit Kit de Chemise Camisas de los cilindros лайнер комплект	CYL. LINER Zylinderlaufbuchse Chemise Camisas de los cilindros втулка цилиндра	PISTON + RINGS Kolben + Ringe Piston + Segments Pistón Set Поршень и кольца		PISTON SET Kolben Set Set de Piston Pistón Set поршневой	RINGS SET Kolben Set Segments de Piston Anillos Set кольца	PIN Pin Axe Perno Пин
<b>ATD/AVB AXR/ BKC/BXE</b> 4 Cyl 79.5 mm Bore Ø 1,896 cc  		Length: 152.0 Outside Ø: 82.5 Flange Ø: 85.5 flange depth 4.7	STD	O/S	alfin and with oil gallery skirt MOS2 treated pin bushing inserted fits tapered con. rod	Top: 1.75 2nd: 2.0 3rd: 3.0 1st oil: 2nd oil:	Ø: 26.0 Length: 66.0
			Length: 69.8	69.55			
			Comp: 45.8	45.55			
			Height: -1.1	-1.1			
			-17.75	-17.75			
			Reference no.:	Reference no.:	Reference no.:	Reference no.:	O-RING
			A-SU351317 G-1402795000 K-89434190 M-029WV20	K-99851600 M-0306600		A-R60370 G-0811490000 K-80000810000 K-800051640000 M-03020N0	
NM-Germany Article no. Artikelnummer/ Modelo Número / статья НОМЕР	NM-Germany Article no.	NM-Germany Article no.	NM-Germany Article no.	NM-Germany Article no.	NM-Germany Article no.	NM-Germany Article no.	NM-Germany Article no.
	LBSAD40041DSB (for cyl 3/4)	LBAD40041DSB	KBSAD40041DB (for cyl 3/4)	KBAD40041DB (for cyl 3/4)	KRAD40041DB		

## DIESEL

ENGINE TYPE Motortyp Type de Moteur Tipo de motor Тип двигателя	LINER KIT Liner Kit Kit de Chemise Camisas de los cilindros лайнер комплект	CYL. LINER Zylinderlaufbuchse Chemise Camisas de los cilindros втулка цилиндра	PISTON + RINGS Kolben + Ringe Piston + Segments Pistón Set Поршень и кольца		PISTON SET Kolben Set Set de Piston Pistón Set поршневой	RINGS SET Kolben Set Segments de Piston Anillos Set кольца	PIN Pin Axe Perno Пин
<b>BHC TURBO</b> 3 Cyl 79.5 mm Bore Ø 1,422 cc  		Length: 152.0 Outside Ø: 82.5 Flange Ø: 85.5 flange depth 4.7	STD	O/S	alfin top ring land and skirt MOS2 treated pin bushing inserted fits tapered con. rod	Top: 1.75 2nd: 2.0 3rd: 3.0 1st oil: 2nd oil:	Ø: 26.0 Length: 63.0
			Length: 69.8	69.8			
			Comp: 45.8	45.5			
			Height: -8.7	-8.7			
			-17.6	-17.6			
			Reference no.:	Reference no.:	Reference no.:	Reference no.:	O-RING
			A-SU351317 G-1402795000 K-89434190 M-029WV20	M-0305400		A-R60370 G-0811490000 K-80000810000 K-800051640000 M-03020N0	
NM-Germany Article no. Artikelnummer/ Modelo Número / статья НОМЕР	NM-Germany Article no.	NM-Germany Article no.	NM-Germany Article no.	NM-Germany Article no.	NM-Germany Article no.	NM-Germany Article no.	NM-Germany Article no.
	LBSAD30042DSA (for cyl 1/2)	LBAD30042DSA	KBSAD30042DA (for cyl 1/2)	KBAD30042DA (for cyl 1/2)	KRAD30042DA		

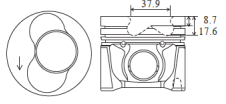
## DIESEL

ENGINE TYPE Motortyp Type de Moteur Tipo de motor Тип двигателя	LINER KIT Liner Kit Kit de Chemise Camisas de los cilindros лайнер комплект	CYL. LINER Zylinderlaufbuchse Chemise Camisas de los cilindros втулка цилиндра	PISTON + RINGS Kolben + Ringe Piston + Segments Pistón Set Поршень и кольца		PISTON SET Kolben Set Set de Piston Pistón Set поршневой	RINGS SET Kolben Set Segments de Piston Anillos Set кольца	PIN Pin Axe Perno Пин
<b>BHC TURBO</b> 3 Cyl 79.5 mm Bore Ø 1,422 cc  		Length: 152.0 Outside Ø: 82.5 Flange Ø: 85.5 flange depth 4.7	STD	O/S	alfin top ring land and skirt MOS2 treated pin bushing inserted fits tapered con. rod	Top: 1.75 2nd: 2.0 3rd: 3.0 1st oil: 2nd oil:	Ø: 26.0 Length: 63.0
			Length: 69.8	69.8			
			Comp: 45.8	45.5			
			Height: -8.7	-8.7			
			-17.6	-17.6			
			Reference no.:	Reference no.:	Reference no.:	Reference no.:	O-RING
			A-SU351317 G-1402795000 K-89434190 M-029WV20	M-0305500		A-R60370 G-0811490000 K-80000810000 K-800051640000 M-03020N0	
NM-Germany Article no. Artikelnummer/ Modelo Número / статья НОМЕР	NM-Germany Article no.	NM-Germany Article no.	NM-Germany Article no.	NM-Germany Article no.	NM-Germany Article no.	NM-Germany Article no.	NM-Germany Article no.
	LBSAD30043DSA (for cyl 3)	LBAD30043DSA	KBSAD30043DA (for cyl 3)	KBAD30043DA (for cyl 3)	KRAD30043DA		

ENGINE TYPE Motortyp Type de Moteur Tipo de motor Тип двигателя	LINER KIT Liner Kit Kit de Chemise Camisas de los cilindros лайнер комплект	CYL. LINER Zylinderaufbuchse Chemise Camisas de los cilindros втулка цилиндра	PISTON + RINGS Kolben + Ringe Piston + Segments Pistón Set Поршень и кольца		PISTON SET Kolben Set Set de Piston Pistón Set поршневой	RINGS SET Kolben Set Segments de Piston Anillos Set кольца	PIN Pin Axe Perno Пин		
<b>BLS BXE</b> 4 Cyl 79.5 mm Bore Ø 1,896 cc		Length: Outside Ø: Flange Ø: flange depth	Length:	69.8	69.55	alfin pin bushing inserted fits tapered con. rod	Top:	1.75	Ø: 26.0 Length: 66.0
			Comp:	45.8	45.55		2nd:	2.0	
			Height:	-17.34	-17.34		3rd:	3.0	
			Reference no.:	Reference no.:	Reference no.:	Reference no.:	O-RING		
				<b>K-40421600</b>		<b>A-R60370 G-0811490000 K-800000810000 K-800051640000 M-03020N0</b>			
NM-Germany Article no. Artikelnummer/ Modelo Número / статья НОМЕР	NM-Germany Article no.	NM-Germany Article no.	NM-Germany Article no.	NM-Germany Article no.	NM-Germany Article no.	NM-Germany Article no.	NM-Germany Article no.		
			<b>KBSAD40044DA</b> (for cyl 1/2)	<b>KBAD40044DA</b> (for cyl 1/2)	<b>KRAD40044DA</b>				

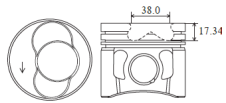

DIESEL

ENGINE TYPE Motortyp Type de Moteur Tipo de motor Тип двигателя	LINER KIT Liner Kit Kit de Chemise Camisas de los cilindros лайнер комплект	CYL. LINER Zylinderaufbuchse Chemise Camisas de los cilindros втулка цилиндра	PISTON + RINGS Kolben + Ringe Piston + Segments Pistón Set Поршень и кольца		PISTON SET Kolben Set Set de Piston Pistón Set поршневой	RINGS SET Kolben Set Segments de Piston Anillos Set кольца	PIN Pin Axe Perno Пин		
<b>BLS BXE</b> 4 Cyl 79.5 mm Bore Ø 1,896 cc		Length: Outside Ø: Flange Ø: flange depth	Length:	69.8	69.55	alfin pin bushing inserted fits tapered con. rod	Top:	1.75	Ø: 26.0 Length: 66.0
			Comp:	45.8	45.55		2nd:	2.0	
			Height:	-17.34	-17.34		3rd:	3.0	
			Reference no.:	Reference no.:	Reference no.:	Reference no.:	O-RING		
				<b>K-40422600</b>		<b>A-R60370 G-0811490000 K-800000810000 K-800051640000 M-03020N0</b>			
NM-Germany Article no. Artikelnummer/ Modelo Número / статья НОМЕР	NM-Germany Article no.	NM-Germany Article no.	NM-Germany Article no.	NM-Germany Article no.	NM-Germany Article no.	NM-Germany Article no.	NM-Germany Article no.		
			<b>KBSAD40045DA</b> (for cyl 3/4)	<b>KBAD40045DA</b> (for cyl 3/4)	<b>KRAD40045DA</b>				

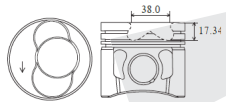



GASOLINE

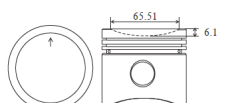

ENGINE TYPE Motortyp Type de Moteur Tipo de motor Тип двигателя	LINER KIT Liner Kit Kit de Chemise Camisas de los cilindros лайнер комплект	CYL. LINER Zylinderaufbuchse Chemise Camisas de los cilindros втулка цилиндра	PISTON + RINGS Kolben + Ringe Piston + Segments Pistón Set Поршень и кольца		PISTON SET Kolben Set Set de Piston Pistón Set поршневой	RINGS SET Kolben Set Segments de Piston Anillos Set кольца	PIN Pin Axe Perno Пин		
<b>FR FP WY</b> 4 Cyl 79.5 mm Bore Ø 1,588 cc		Length: Outside Ø: Flange Ø: flange depth	Length:	73.8		Top:	1.75	Ø: 22.0 Length: 63.0	
			Comp:	41.8			2nd:		2.0
			Height:	-6.1			3rd:		4.0
			Reference no.:	Reference no.:	Reference no.:	Reference no.:	O-RING		
						<b>A-R40200 G-0840410000 K-800000911000 K-800000941000 M-03459V0 T-50003</b>			
NM-Germany Article no. Artikelnummer/ Modelo Número / статья НОМЕР	NM-Germany Article no.	NM-Germany Article no.	NM-Germany Article no.	NM-Germany Article no.	NM-Germany Article no.	NM-Germany Article no.	NM-Germany Article no.		
			<b>KBSAD40046DG</b>	<b>KBAD40046DG</b>	<b>KRAD40046DG</b>				

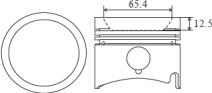

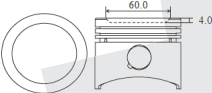

**GASOLINE**

ENGINE TYPE Motortyp Type de Moteur Tipo de motor Тип двигателя	LINER KIT Liner Kit Kit de Chemise Camisas de los cilindros лайнер комплект	CYL. LINER Zylinderlaufbuchse Chemise Camisas de los cilindros втулка цилиндра	PISTON + RINGS Kolben + Ringe Piston + Segments Pistón Set Поршень и кольца		PISTON SET Kolben Set Set de Piston Pistón Set поршневой	RINGS SET Kolben Set Segments de Piston Anillos Set кольца	PIN Pin Axe Perno Пин			
<b>GV/KJ TURBO</b> <b>WJ/WS/WR TURBO</b> 5 Cyl 79.5 mm Bore Ø 2,144 cc 		Length: Outside Ø: Flange Ø: flange depth	Length: 70.5 Comp: 40.5 Height: -12.5			Top: 1.75 2nd: 2.0 3rd: 1st oil: 4.0 2nd oil:	Ø: 22.0 Length: 67.0			
						Reference no.:	Reference no.:	Reference no.:	Reference no.:	O-RING
							<b>K-93430600</b> <b>M-0346700</b>		<b>A-R40200</b> <b>G-0840410000</b> <b>K-800000911000</b> <b>K-800000941000</b> <b>M-03459V0</b> <b>T-50003</b>	
NM-Germany Article no. Artikelnummer/ Modelo Número / статья НОМЕР	NM-Germany Article no.	NM-Germany Article no.	NM-Germany Article no.	NM-Germany Article no.	NM-Germany Article no.	NM-Germany Article no.	NM-Germany Article no.			
			KBSAD50047G	KBAD50047G	KRAD50047G					

**GASOLINE**

ENGINE TYPE Motortyp Type de Moteur Tipo de motor Тип двигателя	LINER KIT Liner Kit Kit de Chemise Camisas de los cilindros лайнер комплект	CYL. LINER Zylinderlaufbuchse Chemise Camisas de los cilindros втулка цилиндра	PISTON + RINGS Kolben + Ringe Piston + Segments Pistón Set Поршень и кольца		PISTON SET Kolben Set Set de Piston Pistón Set поршневой	RINGS SET Kolben Set Segments de Piston Anillos Set кольца	PIN Pin Axe Perno Пин		
<b>WB</b> 5 Cyl 79.5 mm Bore Ø 2,144 cc 		Length: Outside Ø: Flange Ø: flange depth	STD O/S Length: 69.5 69.2 Comp: 38.5 38.2 Height: -4.0 -4.0			Top: 1.75 2nd: 2.0 3rd: 1st oil: 4.0 2nd oil:	Ø: 22.0 Length: 63.0		
			Reference no.:			Reference no.:	Reference no.:	Reference no.:	O-RING
						<b>K-93169600</b> <b>M-0345800</b>		<b>A-R40200</b> <b>G-0840410000</b> <b>K-800000911000</b> <b>K-800000941000</b> <b>M-03459V0</b> <b>T-50003</b>	
NM-Germany Article no. Artikelnummer/ Modelo Número / статья НОМЕР	NM-Germany Article no.	NM-Germany Article no.	NM-Germany Article no.	NM-Germany Article no.	NM-Germany Article no.	NM-Germany Article no.	NM-Germany Article no.		
			KBSAD50048G	KBAD50048G	KRAD50048DG				

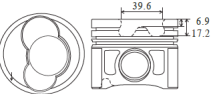
**DIESEL**

ENGINE TYPE Motortyp Type de Moteur Tipo de motor Тип двигателя	LINER KIT Liner Kit Kit de Chemise Camisas de los cilindros лайнер комплект	CYL. LINER Zylinderlaufbuchse Chemise Camisas de los cilindros втулка цилиндра	PISTON + RINGS Kolben + Ringe Piston + Segments Pistón Set Поршень и кольца		PISTON SET Kolben Set Set de Piston Pistón Set поршневой	RINGS SET Kolben Set Segments de Piston Anillos Set кольца	PIN Pin Axe Perno Пин		
<b>ACV/AGX/AHD/AHY</b> <b>AJT/ANJ/APA/AUF</b> <b>AXG/AYC/AYY/BBE/</b> <b>BBF</b> 5 Cyl 81.0 mm Bore Ø 2,461 cc 	<b>(A)</b> <b>M-0305890</b> consists of (C)	(C) (D) Length: 158.0 180.0 Outside Ø: 84.0 84.0 Flange Ø: 85.0 87.0 flange depth 5.0 4.7	STD O/S Length: 69.75 69.5 Comp: 45.75 45.5 Height: -6.9 -6.9		alfin head anodized skirt MOS2 treated pin bushing inserted pin boss gap=27mm	Top: 2.5 2nd: 2.0 3rd: 1st oil: 3.0 2nd oil:	Ø: 26.0 Length: 68.0		
			Reference no.:			Reference no.:	Reference no.:	Reference no.:	O-RING
			<b>(C)</b> <b>M-029WV25</b> <b>N-1402042000</b>			<b>K-99742700</b> <b>M-0305800</b> <b>N-8750150000</b>		<b>A-R60330</b> <b>G-0842100000</b> <b>G-0850150000</b> <b>K-800001150000</b> <b>K-800073910000</b> <b>M-03048N0</b> <b>M-03490N0</b>	
NM-Germany Article no. Artikelnummer/ Modelo Número / статья НОМЕР	NM-Germany Article no.	NM-Germany Article no.	NM-Germany Article no.	NM-Germany Article no.	NM-Germany Article no.	NM-Germany Article no.	NM-Germany Article no.		
	(for cyl 1/2) LBSAD50049DAS1 (A) LBSAD50049DAS2 (B)	LBAD50049DAS1 (C) LBAD50049DAS2 (D)	(for cyl 1/2) KBSAD50049D	(for cyl 1/2) KBAD50049D	KRAD50049D				



ENGINE TYPE	LINER KIT	CYL. LINER	PISTON + RINGS	PISTON SET	RINGS SET	PIN
Motorotyp Type de Moteur Tipo de motor Тип двигателя	Liner Kit Kit de Chemise Camisas de los cilindros лайнер комплект	Zylinderlaufbuchse Chemise Camisas de los cilindros втулка цилиндра	Kolben + Ringe Piston + Segments Pistón Set Поршень и кольца	Kolben Set Set de Piston Pistón Set поршневой	Kolben Set Segments de Piston Anillos Set кольца	Pin Axe Perno Пин
<b>ACV/AGX/AHD/ AHY AJT/ANJ/ APA/AUF AXG/ AYC/AYY/BBE BBF</b>	<b>(A) M-0305990 consists of (C)</b>  <b>(B) consists of (D)</b>					
<b>5 Cyl</b> <b>81.0 mm Bore Ø</b> <b>2,461 cc</b>						
NM-Germany Article no. Artikelnummer/ Modelo Número / статья НОМЕР	NM-Germany Article no.	NM-Germany Article no.	NM-Germany Article no.	NM-Germany Article no.	NM-Germany Article no.	NM-Germany Article no.
	(for cyl 3/4/5) LBSAD50050DAS1 (A) LBSAD50050DAS2 (B)	(for cyl 3/4/5) LBAD50050DAS1 (C) LBAD50050DAS2 (D)	KBSAD50050D	(for cyl 3/4/5) KBAD50050D	KRAD50050D	

AUDI



**DIESEL**

ENGINE TYPE	LINER KIT	CYL. LINER	PISTON + RINGS	PISTON SET	RINGS SET	PIN
Motorotyp Type de Moteur Tipo de motor Тип двигателя	Liner Kit Kit de Chemise Camisas de los cilindros лайнер комплект	Zylinderlaufbuchse Chemise Camisas de los cilindros втулка цилиндра	Kolben + Ringe Piston + Segments Pistón Set Поршень и кольца	Kolben Set Set de Piston Pistón Set поршневой	Kolben Set Segments de Piston Anillos Set кольца	Pin Axe Perno Пин
<b>BPW</b>						
<b>4 Cyl</b> <b>81.0 mm Bore Ø</b> <b>1,968 cc</b>						
NM-Germany Article no. Artikelnummer/ Modelo Número / статья НОМЕР	NM-Germany Article no.	NM-Germany Article no.	NM-Germany Article no.	NM-Germany Article no.	NM-Germany Article no.	NM-Germany Article no.
			(for cyl 1/2) KBSAD40051DB	(for cyl 1/2) KBAD40051DB	KBAD40051DB	

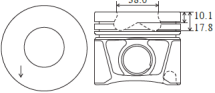

**DIESEL**

ENGINE TYPE	LINER KIT	CYL. LINER	PISTON + RINGS	PISTON SET	RINGS SET	PIN
Motorotyp Type de Moteur Tipo de motor Тип двигателя	Liner Kit Kit de Chemise Camisas de los cilindros лайнер комплект	Zylinderlaufbuchse Chemise Camisas de los cilindros втулка цилиндра	Kolben + Ringe Piston + Segments Pistón Set Поршень и кольца	Kolben Set Set de Piston Pistón Set поршневой	Kolben Set Segments de Piston Anillos Set кольца	Pin Axe Perno Пин
<b>BPW</b>						
<b>4 Cyl</b> <b>81.0 mm Bore Ø</b> <b>1,968 cc</b>						
NM-Germany Article no. Artikelnummer/ Modelo Número / статья НОМЕР	NM-Germany Article no.	NM-Germany Article no.	NM-Germany Article no.	NM-Germany Article no.	NM-Germany Article no.	NM-Germany Article no.
			(for cyl 3/4) KBSAD40052DB	(for cyl 3/4) KBAD40052DB	KBAD40052DB	

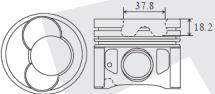

**DIESEL**

ENGINE TYPE Motortyp Type de Moteur Tipo de motor Тип двигателя	LINER KIT Liner Kit Kit de Chemise Camisas de los cilindros лайнер комплект	CYL. LINER Zylinderlaufbuchse Chemise Camisas de los cilindros втулка цилиндра	PISTON + RINGS Kolben + Ringe Piston + Segments Pistón Set Поршень и кольца		PISTON SET Kolben Set Set de Piston Pistón Set поршневой	RINGS SET Kolben Set Segments de Piston Anillos Set кольца	PIN Pin Axe Perno Пин
<b>BLB/BNA/BRD BRE/BRF/BUY BVA/BVF/BVG</b>  4 Cyl  81.0 mm Bore Ø  1,968 cc		Length: 38.0 Outside Ø: 10.1 Flange Ø: 17.8 flange depth	Length: 68.8 Comp: 45.8 Height: -10.1 -17.8	STD 0.25 0.50 68.55 45.55 -10.1 -17.8	alfin and with oil gallery skirt MOS2 treated pin bushing inserted fits tapered con. rod	Top: 1.75 2nd: 2.0 3rd: 3.0 1st oil: 2nd oil:	Ø: 26.0 Length: 66.0
		Reference no.:	Reference no.:	Reference no.:	Reference no.:	O-RING	
			<b>K-40387600 N-8713950000</b>		<b>G-0813950000 K-800070540000 K-800072710000</b>		
NM-Germany Article no. Artikelnummer/ Modelo Número / статья НОМЕР	NM-Germany Article no.	NM-Germany Article no.	NM-Germany Article no.	NM-Germany Article no.	NM-Germany Article no.	NM-Germany Article no.	NM-Germany Article no.
			<b>KBSAD40053DB</b>	<b>KBAD40053DB</b>	<b>KRAD40053DB</b>		

**DIESEL**

ENGINE TYPE Motortyp Type de Moteur Tipo de motor Тип двигателя	LINER KIT Liner Kit Kit de Chemise Camisas de los cilindros лайнер комплект	CYL. LINER Zylinderlaufbuchse Chemise Camisas de los cilindros втулка цилиндра	PISTON + RINGS Kolben + Ringe Piston + Segments Pistón Set Поршень и кольца		PISTON SET Kolben Set Set de Piston Pistón Set поршневой	RINGS SET Kolben Set Segments de Piston Anillos Set кольца	PIN Pin Axe Perno Пин
<b>AXD/AXE TURBO BAC/BLJ/BLK TURBO</b>  5 Cyl  81.0 mm Bore Ø  2,461 cc 2,498 cc		Length: 158.0 Outside Ø: 84.0 Flange Ø: 85.0 flange depth 5.0	Length: 69.75 Comp: 45.75 Height: -18.2	alfin and with oil gallery pin bushing inserted fits tapered con. rod	Top: 2.5 2nd: 2.0 3rd: 3.0 1st oil: 2nd oil:	Ø: 26.0 Length: 65.0	
		Reference no.:	Reference no.:	Reference no.:	Reference no.:	O-RING	
		<b>M-029WV25 N-1402042000</b>	<b>M-0309700 N-8742100010</b>		<b>A-R60330 G-0842100000 G-0850150000 K-80001150000 K-800073910000 M-03048N0 M-03490N0</b>		
NM-Germany Article no. Artikelnummer/ Modelo Número / статья НОМЕР	NM-Germany Article no.	NM-Germany Article no.	NM-Germany Article no.	NM-Germany Article no.	NM-Germany Article no.	NM-Germany Article no.	NM-Germany Article no.
	<b>LBSAD50054DSB (for cyl 1/2)</b>	<b>LBAD50054DSB</b>	<b>KBSAD50054DB (for cyl 1/2)</b>	<b>KBAD50054DB (for cyl 1/2)</b>	<b>KRAD50054DB</b>		

**DIESEL**

ENGINE TYPE Motortyp Type de Moteur Tipo de motor Тип двигателя	LINER KIT Liner Kit Kit de Chemise Camisas de los cilindros лайнер комплект	CYL. LINER Zylinderlaufbuchse Chemise Camisas de los cilindros втулка цилиндра	PISTON + RINGS Kolben + Ringe Piston + Segments Pistón Set Поршень и кольца		PISTON SET Kolben Set Set de Piston Pistón Set поршневой	RINGS SET Kolben Set Segments de Piston Anillos Set кольца	PIN Pin Axe Perno Пин
<b>AXD/AXE TURBO BAC/BLJ/BLK TURBO</b>  5 Cyl  81.0 mm Bore Ø  2,461 cc 2,498 cc		Length: 158.0 Outside Ø: 84.0 Flange Ø: 85.0 flange depth 5.0	Length: 69.75 Comp: 45.75 Height: -18.2	alfin and with oil gallery pin bushing inserted fits tapered con. rod	Top: 2.5 2nd: 2.0 3rd: 3.0 1st oil: 2nd oil:	Ø: 26.0 Length: 65.0	
		Reference no.:	Reference no.:	Reference no.:	Reference no.:	O-RING	
		<b>M-029WV25 N-1402042000</b>	<b>M-0309800 N-8742100020</b>		<b>A-R60330 G-0842100000 G-0850150000 K-80001150000 K-800073910000 M-03048N0 M-03490N0</b>		
NM-Germany Article no. Artikelnummer/ Modelo Número / статья НОМЕР	NM-Germany Article no.	NM-Germany Article no.	NM-Germany Article no.	NM-Germany Article no.	NM-Germany Article no.	NM-Germany Article no.	NM-Germany Article no.
	<b>LBSAD50055DSB (for cyl 3/4/5)</b>	<b>LBAD50055DSB</b>	<b>KBSAD50055DB (for cyl 3/4/5)</b>	<b>KBAD50055DB (for cyl 3/4/5)</b>	<b>KRAD50055DB</b>		



ENGINE TYPE Motortyp Type de Moteur Tipo de motor Тип двигателя	LINER KIT Liner Kit Kit de Chemise Camisas de los cilindros лайнер комплект	CYL. LINER Zylinderlaufbuchse Chemise Camisas de los cilindros втулка цилиндра	PISTON + RINGS Kolben + Ringe Piston + Segments Pistón Set Поршень и кольца		PISTON SET Kolben Set Set de Piston Pistón Set поршневой	RINGS SET Kolben Set Segments de Piston Anillos Set кольца	PIN Pin Axe Perno Пин			
<b>1T/AAT/ABP/AEL</b> <b>5 Cyl</b> <b>81.0 mm Bore Ø</b> <b>2,461 cc</b>	<b>(A)</b> consists of (C)  <b>(B)</b> consists of (D)		(C)	(D)	STD	O/S	alfin skirt MOS2 treated pin bushing inserted pin boss gap=22.2mm	Top: 2.5 2nd: 2.0 3rd: 3.0 1st oil: 2nd oil: 3.0	Ø: 26.0  Length: 68.0	
		Length:	158.0	158.0	Length:	69.75				69.5
		Outside Ø:	84.0	84.0	Comp:	45.75				45.5
		Flange Ø:	86.0	Height:	-7.0	-7.0				
		flange depth	4.0		-17.2	-17.2				
		Reference no.:		Reference no.:	Reference no.:	Reference no.:	O-RING			
				<b>K-94429700</b> <b>M-0349000</b> <b>N-8750150020</b>		<b>A-R60330</b> <b>G-0842100000</b> <b>G-0850150000</b> <b>K-800001150000</b> <b>K-800073910000</b> <b>M-03048N0</b> <b>M-03490N0</b>				
NM-Germany Article no. Artikelnummer/ Modelo Número / статья НОМЕР	NM-Germany Article no.	NM-Germany Article no.	NM-Germany Article no.	NM-Germany Article no.	NM-Germany Article no.	NM-Germany Article no.	NM-Germany Article no.			
	(for cyl 1/2) <b>LBSAD50056DAP (A)</b> <b>LBSAD50056DAS (B)</b>	<b>LBAD50056DAP (C)</b> <b>LBAD50056DAS (D)</b>	(for cyl 1/2) <b>KBSAD50056DA</b>	(for cyl 1/2) <b>KBAD50056DA</b>	<b>KRAD50056DA</b>					

AUDI



DIESEL										
ENGINE TYPE Motortyp Type de Moteur Tipo de motor Тип двигателя	LINER KIT Liner Kit Kit de Chemise Camisas de los cilindros лайнер комплект	CYL. LINER Zylinderlaufbuchse Chemise Camisas de los cilindros втулка цилиндра	PISTON + RINGS Kolben + Ringe Piston + Segments Pistón Set Поршень и кольца		PISTON SET Kolben Set Set de Piston Pistón Set поршневой	RINGS SET Kolben Set Segments de Piston Anillos Set кольца	PIN Pin Axe Perno Пин			
<b>1T/AAT/ABP/AEL</b> <b>5 Cyl</b> <b>81.0 mm Bore Ø</b> <b>2,461 cc</b>	<b>(A)</b> consists of (C)  <b>(B)</b> consists of (D)		(C)	(D)	STD	O/S	alfin skirt MOS2 treated pin bushing inserted pin boss gap=22.2mm	Top: 2.5 2nd: 2.0 3rd: 3.0 1st oil: 2nd oil: 3.0	Ø: 26.0  Length: 68.0	
		Length:	158.0	158.0	Length:	69.75				69.5
		Outside Ø:	84.0	84.0	Comp:	45.75				45.5
		Flange Ø:	86.0	Height:	-7.0	-7.0				
		flange depth	4.0		-17.2	-17.2				
		Reference no.:		Reference no.:	Reference no.:	Reference no.:	O-RING			
				<b>K-94430700</b> <b>M-0349100</b> <b>N-8750150030</b>		<b>A-R60330</b> <b>G-0842100000</b> <b>G-0850150000</b> <b>K-800001150000</b> <b>K-800073910000</b> <b>M-03048N0</b> <b>M-03490N0</b>				
NM-Germany Article no. Artikelnummer/ Modelo Número / статья НОМЕР	NM-Germany Article no.	NM-Germany Article no.	NM-Germany Article no.	NM-Germany Article no.	NM-Germany Article no.	NM-Germany Article no.	NM-Germany Article no.			
	(for cyl 3/4/5) <b>LBSAD50057DAP (A)</b> <b>LBSAD50057DAS (B)</b>	<b>LBAD50057DAP (C)</b> <b>LBAD50057DAS (D)</b>	(for cyl 3/4/5) <b>KBSAD50057DA</b>	(for cyl 3/4/5) <b>KBAD50057DA</b>	<b>KRAD50057DA</b>					

DIESEL										
ENGINE TYPE Motortyp Type de Moteur Tipo de motor Тип двигателя	LINER KIT Liner Kit Kit de Chemise Camisas de los cilindros лайнер комплект	CYL. LINER Zylinderlaufbuchse Chemise Camisas de los cilindros втулка цилиндра	PISTON + RINGS Kolben + Ringe Piston + Segments Pistón Set Поршень и кольца		PISTON SET Kolben Set Set de Piston Pistón Set поршневой	RINGS SET Kolben Set Segments de Piston Anillos Set кольца	PIN Pin Axe Perno Пин			
<b>CAGA/CAGB</b> <b>CAGC/CAHA CAHB/</b> <b>CBAA/CBAB</b>  <b>4 Cyl</b> <b>81.0 mm Bore Ø</b> <b>1,968 cc</b>							alfin and with oil gallery skirt MOS2 treated pin bushing inserted fits tapered con. rod	Top: 1.75 2nd: 2.0 3rd: 3.0 1st oil: 2nd oil: 3.0	Ø: 26.0  Length: 66.0	
		Length:			Length:	68.8				
		Outside Ø:			Comp:	45.8				
		Flange Ø:			Height:	-7.9				
		flange depth				-12.7				
		Reference no.:		Reference no.:	Reference no.:	Reference no.:	O-RING			
				<b>K-40558600</b>		<b>G-0813950000</b> <b>K-800070540000</b> <b>K-800072710000</b>				
NM-Germany Article no. Artikelnummer/ Modelo Número / статья НОМЕР	NM-Germany Article no.	NM-Germany Article no.	NM-Germany Article no.	NM-Germany Article no.	NM-Germany Article no.	NM-Germany Article no.	NM-Germany Article no.			
			<b>KBSAD40058DB</b>	<b>KBAD40058DB</b>	<b>KRAD40058DB</b>					



**GASOLINE**

ENGINE TYPE Motortyp Type de Moteur Tipo de motor Тип двигателя	LINER KIT Liner Kit Kit de Chemise Camisas de los cilindros лайнер комплект	CYL. LINER Zylinderlaufbuchse Chemise Camisas de los cilindros втулка цилиндра	PISTON + RINGS Kolben + Ringe Piston + Segments Pistón Set Поршень и кольца		PISTON SET Kolben Set Set de Piston Pistón Set поршневой	RINGS SET Kolben Set Segments de Piston Anillos Set кольца	PIN Pin Axe Perno Пин	
<b>ABB</b> <b>HP/JS/KP/PS/RT</b> 4/5 Cyl 81.0 mm Bore Ø 1,598 cc 1,994 cc		Length: Outside Ø: Flange Ø: flange depth	Length: 66.8 66.5 Comp: 35.6 35.3 Height: +2.2 +2.2	STD    O/S	Top: 1.5 2nd: 1.75 3rd: 1st oil: 3.0 2nd oil:	Ø: 20.0 Length: 57.0	Reference no.: Reference no.: Reference no.: Reference no.: O-RING	
		Reference no.:	Reference no.:	Reference no.:				Reference no.:
			<b>K-93871600</b> <b>M-0345300</b>					<b>A-R60300</b> <b>G-0850190000</b> <b>K-800001011000</b> <b>M-03475N0</b>
NM-Germany Article no. Artikelnummer/ Modelo Número / статья НОМЕР	NM-Germany Article no.	NM-Germany Article no.	NM-Germany Article no.	NM-Germany Article no.	NM-Germany Article no.	NM-Germany Article no.	NM-Germany Article no.	
			<b>KBSAD450059G</b>	<b>KBAD450059G</b>	<b>KRAD450059G</b>			

**GASOLINE**

ENGINE TYPE Motortyp Type de Moteur Tipo de motor Тип двигателя	LINER KIT Liner Kit Kit de Chemise Camisas de los cilindros лайнер комплект	CYL. LINER Zylinderlaufbuchse Chemise Camisas de los cilindros втулка цилиндра	PISTON + RINGS Kolben + Ringe Piston + Segments Pistón Set Поршень и кольца		PISTON SET Kolben Set Set de Piston Pistón Set поршневой	RINGS SET Kolben Set Segments de Piston Anillos Set кольца	PIN Pin Axe Perno Пин	
<b>DR/DS/MG PM/RS/RU/SF</b> 4 Cyl 81.0 mm Bore Ø 1,781 cc		Length: Outside Ø: Flange Ø: flange depth	Length: 62.5 62.2 Comp: 32.2 31.9 Height: +1.3 +1.3	STD    O/S	Top: 1.5 2nd: 1.75 3rd: 1st oil: 3.0 2nd oil:	Ø: 20.0 Length: 57.0	Reference no.: Reference no.: Reference no.: Reference no.: O-RING	
		Reference no.:	Reference no.:	Reference no.:				Reference no.:
			<b>K-93876600</b> <b>M-0347800</b> <b>N-8710970010</b>					<b>A-R60300</b> <b>G-0850190000</b> <b>K-800001011000</b> <b>M-03475N0</b>
NM-Germany Article no. Artikelnummer/ Modelo Número / статья НОМЕР	NM-Germany Article no.	NM-Germany Article no.	NM-Germany Article no.	NM-Germany Article no.	NM-Germany Article no.	NM-Germany Article no.	NM-Germany Article no.	
			<b>KBSAD40060G</b>	<b>KBAD40060G</b>	<b>KRAD40060G</b>			

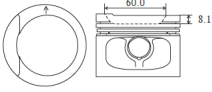
**GASOLINE**

ENGINE TYPE Motortyp Type de Moteur Tipo de motor Тип двигателя	LINER KIT Liner Kit Kit de Chemise Camisas de los cilindros лайнер комплект	CYL. LINER Zylinderlaufbuchse Chemise Camisas de los cilindros втулка цилиндра	PISTON + RINGS Kolben + Ringe Piston + Segments Pistón Set Поршень и кольца		PISTON SET Kolben Set Set de Piston Pistón Set поршневой	RINGS SET Kolben Set Segments de Piston Anillos Set кольца	PIN Pin Axe Perno Пин	
<b>JN</b> 4 Cyl 81.0 mm Bore Ø 1,781 cc		Length: Outside Ø: Flange Ø: flange depth	Length: 62.5 62.2 Comp: 32.2 31.9 Height: +1.3 +1.3	STD    O/S	Top: 1.5 2nd: 1.75 3rd: 1st oil: 3.0 2nd oil:	Ø: 20.0 Length: 57.0	Reference no.: Reference no.: Reference no.: Reference no.: O-RING	
		Reference no.:	Reference no.:	Reference no.:				Reference no.:
			<b>K-93875600</b> <b>M-0347700</b>					<b>A-R60300</b> <b>G-0850190000</b> <b>K-800001011000</b> <b>M-03475N0</b>
NM-Germany Article no. Artikelnummer/ Modelo Número / статья НОМЕР	NM-Germany Article no.	NM-Germany Article no.	NM-Germany Article no.	NM-Germany Article no.	NM-Germany Article no.	NM-Germany Article no.	NM-Germany Article no.	
			<b>KBSAD40061G</b>	<b>KBAD40061G</b>	<b>KRAD40061G</b>			

ENGINE TYPE Motortyp Type de Moteur Tipo de motor Тип двигателя	LINER KIT Liner Kit Kit de Chemise Camisas de los cilindros лайнер комплект	CYL. LINER Zylinderlaufbuchse Chemise Camisas de los cilindros втулка цилиндра	PISTON + RINGS Kolben + Ringe Piston + Segments Pistón Set Поршень и кольца		PISTON SET Kolben Set Set de Piston Pistón Set поршневой	RINGS SET Kolben Set Segments de Piston Anillos Set кольца	PIN Pin Axe Perno Пин
<b>ABM DT JU</b> 4 Cyl 81.0 mm Bore Ø 1,595 cc		Length: Outside Ø: Flange Ø: flange depth	STD	O/S		Top: 1.5 2nd: 1.75 3rd: 3.0 1st oil: 2nd oil:	Ø: 20.0 Length: 57.0
			Length: 66.8 66.5 Comp: 35.6 35.3 Height: +2.2 +2.2 -2.3 -2.3				
			Reference no.:	Reference no.:		Reference no.:	
			K-93872600 M-0347600			A-R60300 G-0850190000 K-800001011000 M-03475N0	
NM-Germany Article no. Artikelnummer/ Modelo Número / статья НОМЕР	NM-Germany Article no.	NM-Germany Article no.	NM-Germany Article no.	NM-Germany Article no.	NM-Germany Article no.	NM-Germany Article no.	NM-Germany Article no.
			KBSAD40062G	KBAD40062G		KRAD40062G	

**GASOLINE**

ENGINE TYPE Motortyp Type de Moteur Tipo de motor Тип двигателя	LINER KIT Liner Kit Kit de Chemise Camisas de los cilindros лайнер комплект	CYL. LINER Zylinderlaufbuchse Chemise Camisas de los cilindros втулка цилиндра	PISTON + RINGS Kolben + Ringe Piston + Segments Pistón Set Поршень и кольца		PISTON SET Kolben Set Set de Piston Pistón Set поршневой	RINGS SET Kolben Set Segments de Piston Anillos Set кольца	PIN Pin Axe Perno Пин
<b>ADR/AGN APT/ARG</b> 4 Cyl 81.0 mm Bore Ø 1,781 cc		Length: Outside Ø: Flange Ø: flange depth	STD 0.25	O/S 0.50		Top: 1.5 2nd: 1.75 3rd: 2.0 1st oil: 2nd oil:	Ø: 20.0 Length: 59.0
			Length: 56.8 56.8 Comp: 32.6 32.3 Height: -2.5 -2.5				
			Reference no.:	Reference no.:		Reference no.:	
			K-99559600 M-0331300 N-8750290000			A-R60320 G-0850290000 K-800045040000 M-03304N0 T-50017	
NM-Germany Article no. Artikelnummer/ Modelo Número / статья НОМЕР	NM-Germany Article no.	NM-Germany Article no.	NM-Germany Article no.	NM-Germany Article no.	NM-Germany Article no.	NM-Germany Article no.	NM-Germany Article no.
			KBSAD40063G	KBAD40063G		KRAD40063G	

**GASOLINE**

ENGINE TYPE Motortyp Type de Moteur Tipo de motor Тип двигателя	LINER KIT Liner Kit Kit de Chemise Camisas de los cilindros лайнер комплект	CYL. LINER Zylinderlaufbuchse Chemise Camisas de los cilindros втулка цилиндра	PISTON + RINGS Kolben + Ringe Piston + Segments Pistón Set Поршень и кольца		PISTON SET Kolben Set Set de Piston Pistón Set поршневой	RINGS SET Kolben Set Segments de Piston Anillos Set кольца	PIN Pin Axe Perno Пин
<b>ADP/AEH AHL/ AKL/ARM</b> 4 Cyl 81.0 mm Bore Ø 1,595 cc		Length: Outside Ø: Flange Ø: flange depth	STD	O/S	skirt MOS2 treated	Top: 1.2 2nd: 1.5 3rd: 2.0 1st oil: 2nd oil:	Ø: 20.0 Length: 57.0
			Length: 53.8 53.5 Comp: 32.0 31.7 Height: +0.7 +0.7 -2.3 -2.3				
			Reference no.:	Reference no.:		Reference no.:	
			K-94503700 M-0330100 N-8710590000			A-R60290 G-0810590000 K-8000039440000 M-03301N0	
NM-Germany Article no. Artikelnummer/ Modelo Número / статья НОМЕР	NM-Germany Article no.	NM-Germany Article no.	NM-Germany Article no.	NM-Germany Article no.	NM-Germany Article no.	NM-Germany Article no.	NM-Germany Article no.
			KBSAD40064G	KBAD40064G		KRAD40064G	

## GASOLINE

ENGINE TYPE Motortyp Type de Moteur Tipo de motor Тип двигателя	LINER KIT Liner Kit Kit de Chemise Camisas de los cilindros лайнер комплект	CYL. LINER Zylinderlaufbuchse Chemise Camisas de los cilindros втулка цилиндра	PISTON + RINGS Kolben + Ringe Piston + Segments Pistón Set Поршень и кольца		PISTON SET Kolben Set Set de Piston Pistón Set поршневой	RINGS SET Kolben Set Segments de Piston Anillos Set кольца	PIN Pin Axe Perno Пин
<b>DS/DV JV/NE/PV</b> <b>4 Cyl</b> <b>81.0 mm Bore Ø</b> <b>1,781 cc</b>		Length: Outside Ø: Flange Ø: flange depth	STD	O/S		Top: 1.5 2nd: 1.75 3rd: 1st oil: 3.0 2nd oil:	Ø: 20.0 Length: 57.0
			Length: 62.5	62.2			
			Comp: 32.2	31.9			
		Height: +1.3	+1.3				
		flange depth	-4.4	-4.4			
		Reference no.:	Reference no.:	Reference no.:	Reference no.:	O-RING	
			<b>K-93928600</b> <b>M-0347500</b> <b>N-8710940040</b> <b>N-8710940050</b>		<b>A-R60300</b> <b>G-0850190000</b> <b>K-800001011000</b> <b>M-03475N0</b>		
NM-Germany Article no. Artikelnummer/ Modelo Número / статья НОМЕР	NM-Germany Article no.	NM-Germany Article no.	NM-Germany Article no.	NM-Germany Article no.	NM-Germany Article no.	NM-Germany Article no.	NM-Germany Article no.
			KBSAD40065G	KBAD40065G	KRAD40065G		

## GASOLINE

ENGINE TYPE Motortyp Type de Moteur Tipo de motor Тип двигателя	LINER KIT Liner Kit Kit de Chemise Camisas de los cilindros лайнер комплект	CYL. LINER Zylinderlaufbuchse Chemise Camisas de los cilindros втулка цилиндра	PISTON + RINGS Kolben + Ringe Piston + Segments Pistón Set Поршень и кольца		PISTON SET Kolben Set Set de Piston Pistón Set поршневой	RINGS SET Kolben Set Segments de Piston Anillos Set кольца	PIN Pin Axe Perno Пин
<b>AEB/AGU/AJL</b> <b>AJQ/ANB/APP</b> <b>APU/AQA/ARX/</b> <b>ARZ</b> <b>4 Cyl</b> <b>81.0 mm Bore Ø</b> <b>1,781 cc</b>		Length: Outside Ø: Flange Ø: flange depth	STD	O/S	skirt MOS2 treated	Top: 1.5 2nd: 1.75 3rd: 1st oil: 2.0 2nd oil:	Ø: 20.0 Length: 59.0
			Length: 53.7	53.4			
			Comp: 32.7	32.4			
		Height: -1.4	-1.4				
		flange depth					
		Reference no.:	Reference no.:	Reference no.:	Reference no.:	O-RING	
			<b>K-99933600</b> <b>M-0330400</b> <b>N-8750290010</b>		<b>A-R60320</b> <b>G-0850290000</b> <b>K-800045040000</b> <b>M-03304N0</b> <b>T-50017</b>		
NM-Germany Article no. Artikelnummer/ Modelo Número / статья НОМЕР	NM-Germany Article no.	NM-Germany Article no.	NM-Germany Article no.	NM-Germany Article no.	NM-Germany Article no.	NM-Germany Article no.	NM-Germany Article no.
			KBSAD40066G	KBAD40066G	KRAD40066G		

## GASOLINE

ENGINE TYPE Motortyp Type de Moteur Tipo de motor Тип двигателя	LINER KIT Liner Kit Kit de Chemise Camisas de los cilindros лайнер комплект	CYL. LINER Zylinderlaufbuchse Chemise Camisas de los cilindros втулка цилиндра	PISTON + RINGS Kolben + Ringe Piston + Segments Pistón Set Поршень и кольца		PISTON SET Kolben Set Set de Piston Pistón Set поршневой	RINGS SET Kolben Set Segments de Piston Anillos Set кольца	PIN Pin Axe Perno Пин
<b>KU</b> <b>KV</b> <b>5 Cyl</b> <b>81.0 mm Bore Ø</b> <b>2,226 cc</b>		Length: Outside Ø: Flange Ø: flange depth	STD	O/S		Top: 1.5 2nd: 1.75 3rd: 1st oil: 3.0 2nd oil:	Ø: 20.0 Length: 56.5
			Length: 62.3	62.0			
			Comp: 32.2	31.9			
		Height: 1.1	1.1				
		flange depth	-4.5	-4.5			
		Reference no.:	Reference no.:	Reference no.:	Reference no.:	O-RING	
			<b>K-93825600</b> <b>M-0347400</b> <b>N-8710970030</b>		<b>G-0850190000</b> <b>K-800001011000</b> <b>M-03475N0</b>		
NM-Germany Article no. Artikelnummer/ Modelo Número / статья НОМЕР	NM-Germany Article no.	NM-Germany Article no.	NM-Germany Article no.	NM-Germany Article no.	NM-Germany Article no.	NM-Germany Article no.	NM-Germany Article no.
			KBSAD50067G	KBAD50067G	KRAD50067G		

**GASOLINE**

ENGINE TYPE Motortyp Type de Moteur Tipo de motor Тип двигателя	LINER KIT Liner Kit Kit de Chemise Camisas de los cilindros лайнер комплект	CYL. LINER Zylinderlaufbuchse Chemise Camisas de los cilindros втулка цилиндра	PISTON + RINGS Kolben + Ringe Piston + Segments Pistón Set Поршень и кольца		PISTON SET Kolben Set Set de Piston Pistón Set поршневой	RINGS SET Kolben Set Segments de Piston Anillos Set кольца	PIN Pin Axe Perno Пин		
<b>AMB/ARX TURBO ARY/AVJ TURBO BEX/BFB TURBO</b> 4 Cyl 81.0 mm Bore Ø 1,781 cc		Length: Outside Ø: Flange Ø: flange depth	STD	0.50	top and 2nd ring lands anodized skirt MOS2 treated fits tapered con. rod	Top: 1.5 2nd: 1.75 3rd: 1st oil: 2.0 2nd oil:	Ø: 19.0 Length: 50.0		
			Length: 53.7	53.4		Comp: 32.7	32.4	Height: -1.9	-1.9
			Reference no.:			Reference no.:		Reference no.:	
				K-40434600 M-0331600		A-R60320 G-0850290000 K-800045040000 M-03304N0 T-50017			
NM-Germany Article no. Artikelnummer/ Modelo Número / статья НОМЕР	NM-Germany Article no.	NM-Germany Article no.	NM-Germany Article no.	NM-Germany Article no.	NM-Germany Article no.	NM-Germany Article no.	NM-Germany Article no.		
			KBSAD40068G	KBAD40068G	KRAD40068G				

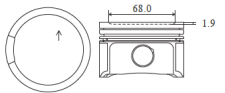

AUDI

**GASOLINE**

ENGINE TYPE Motortyp Type de Moteur Tipo de motor Тип двигателя	LINER KIT Liner Kit Kit de Chemise Camisas de los cilindros лайнер комплект	CYL. LINER Zylinderlaufbuchse Chemise Camisas de los cilindros втулка цилиндра	PISTON + RINGS Kolben + Ringe Piston + Segments Pistón Set Поршень и кольца		PISTON SET Kolben Set Set de Piston Pistón Set поршневой	RINGS SET Kolben Set Segments de Piston Anillos Set кольца	PIN Pin Axe Perno Пин		
<b>AGA/AJG/ALF AML/APC/APS</b> 6 Cyl 81.0 mm Bore Ø 2,393 cc		Length: Outside Ø: Flange Ø: flange depth	STD	O/S	skirt MOS2 treated	Top: 1.5 2nd: 1.5 3rd: 1st oil: 2.0 2nd oil:	Ø: 21.0 Length: 56.0		
			Length: 55.0	54.7		Comp: 28.8	28.5	Height: +5.2	+5.2
			Reference no.:			Reference no.:		Reference no.:	
				K-99949600 M-0331000		K-800045620000 M-03310N0			
NM-Germany Article no. Artikelnummer/ Modelo Número / статья НОМЕР	NM-Germany Article no.	NM-Germany Article no.	NM-Germany Article no.	NM-Germany Article no.	NM-Germany Article no.	NM-Germany Article no.	NM-Germany Article no.		
			KBSAD60069G	KBAD60069G	KRAD60069G				

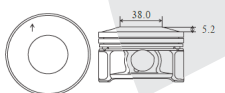



**GASOLINE**

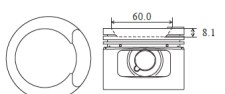

ENGINE TYPE Motortyp Type de Moteur Tipo de motor Тип двигателя	LINER KIT Liner Kit Kit de Chemise Camisas de los cilindros лайнер комплект	CYL. LINER Zylinderlaufbuchse Chemise Camisas de los cilindros втулка цилиндра	PISTON + RINGS Kolben + Ringe Piston + Segments Pistón Set Поршень и кольца		PISTON SET Kolben Set Set de Piston Pistón Set поршневой	RINGS SET Kolben Set Segments de Piston Anillos Set кольца	PIN Pin Axe Perno Пин		
<b>JT/KM KX/KZ</b> 5 Cyl 81.0 mm Bore Ø 2,226 cc		Length: Outside Ø: Flange Ø: flange depth	STD	O/S		Top: 1.5 2nd: 1.75 3rd: 1st oil: 3.0 2nd oil:	Ø: 20.0 Length: 57.0		
			Length: 62.3	62.0		Comp: 32.2	31.9	Height: 1.1	1.1
			Reference no.:			Reference no.:		Reference no.:	
				K-93874600 M-0347900 N-8710970000		A-R60300 G-0850190000 K-800001011000 M-03475N0			
NM-Germany Article no. Artikelnummer/ Modelo Número / статья НОМЕР	NM-Germany Article no.	NM-Germany Article no.	NM-Germany Article no.	NM-Germany Article no.	NM-Germany Article no.	NM-Germany Article no.	NM-Germany Article no.		
			KBSAD50070DG	KBAD50070G	KRAD50070G				

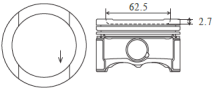

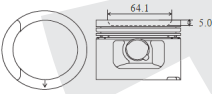

**GASOLINE**

ENGINE TYPE Motortyp Type de Moteur Tipo de motor Тип двигателя	LINER KIT Liner Kit Kit de Chemise Camisas de los cilindros лайнер комплект	CYL. LINER Zylinderlaufbuchse Chemise Camisas de los cilindros втулка цилиндра	PISTON + RINGS Kolben + Ringe Piston + Segments Pistón Set Поршень и кольца		PISTON SET Kolben Set Set de Piston Pistón Set поршень	RINGS SET Kolben Set Segments de Piston Anillos Set кольца	PIN Pin Axe Perno Пин	
<b>ALZ/ANA/AVU BFQ/BGU/BSE BSF</b> 4 Cyl 81.0 mm Bore Ø 1,595 cc  			STD	O/S	skirt MOS2 treated fits tapered con. rod	Top: 1.0 2nd: 1.2 3rd: 2.0 1st oil: 2.0 2nd oil:	Ø: 19.0 Length: 42.0	
	Length:		Length:	50.8 50.45				
	Outside Ø: Flange Ø: flange depth		Comp: Height:	29.7 29.45 -2.7 -2.7				
		Reference no.:	Reference no.:	Reference no.:	Reference no.:	O-RING		
			<b>K-99792600 M-0332000</b>		<b>G-0814830000 K-800049841050 M-03077N0</b>			
NM-Germany Article no. Artikelnummer/ Modelo Número / статья НОМЕР	NM-Germany Article no.	NM-Germany Article no.	NM-Germany Article no.	NM-Germany Article no.	NM-Germany Article no.	NM-Germany Article no.	NM-Germany Article no.	
			<b>KBSAD40071G</b>	<b>KBAD40071G</b>	<b>KRAD40071G</b>			

**GASOLINE**

ENGINE TYPE Motortyp Type de Moteur Tipo de motor Тип двигателя	LINER KIT Liner Kit Kit de Chemise Camisas de los cilindros лайнер комплект	CYL. LINER Zylinderlaufbuchse Chemise Camisas de los cilindros втулка цилиндра	PISTON + RINGS Kolben + Ringe Piston + Segments Pistón Set Поршень и кольца		PISTON SET Kolben Set Set de Piston Pistón Set поршень	RINGS SET Kolben Set Segments de Piston Anillos Set кольца	PIN Pin Axe Perno Пин	
<b>AAD ABK</b> 4 Cyl 82.5 mm Bore Ø 1,984 cc  			STD	O/S		Top: 1.2 2nd: 1.5 3rd: 2.0 1st oil: 2.0 2nd oil:	Ø: 21.0 Length: 59.0	
	Length:		Length:	63.8 63.5				
	Outside Ø: Flange Ø: flange depth		Comp: Height:	30.9 30.6 +0.9 +0.9 -5.0 -5.0				
		Reference no.:	Reference no.:	Reference no.:	Reference no.:	O-RING		
			<b>K-91128600 M-0349900 N-8750180070</b>		<b>A-R60310 G-0850180000 K-800001220000 K-800045720000 M-03031N0 M-03060N0 M-03075N0 M-03319N0 T-50018 T-50025</b>			
NM-Germany Article no. Artikelnummer/ Modelo Número / статья НОМЕР	NM-Germany Article no.	NM-Germany Article no.	NM-Germany Article no.	NM-Germany Article no.	NM-Germany Article no.	NM-Germany Article no.	NM-Germany Article no.	
			<b>KBSAD40072G</b>	<b>KBAD40072G</b>	<b>KRAD40072G</b>			

**GASOLINE**

ENGINE TYPE Motortyp Type de Moteur Tipo de motor Тип двигателя	LINER KIT Liner Kit Kit de Chemise Camisas de los cilindros лайнер комплект	CYL. LINER Zylinderlaufbuchse Chemise Camisas de los cilindros втулка цилиндра	PISTON + RINGS Kolben + Ringe Piston + Segments Pistón Set Поршень и кольца		PISTON SET Kolben Set Set de Piston Pistón Set поршень	RINGS SET Kolben Set Segments de Piston Anillos Set кольца	PIN Pin Axe Perno Пин	
<b>6A ACE</b> 4 Cyl 82.5 mm Bore Ø 1,984 cc  			STD	O/S	skirt MOS2 treated	Top: 1.2 2nd: 1.5 3rd: 2.0 1st oil: 2.0 2nd oil:	Ø: 20.0 Length: 57.0	
	Length:		Length:	54.8 54.5				
	Outside Ø: Flange Ø: flange depth		Comp: Height:	29.8 29.5 -3.1 -3.1 -3.6 -3.6				
		Reference no.:	Reference no.:	Reference no.:	Reference no.:	O-RING		
			<b>K-91504700</b>		<b>A-R60310 G-0850180000 K-800001220000 K-800045720000 M-03031N0 M-03060N0 M-03075N0 M-03319N0 T-50018 T-50025</b>			
NM-Germany Article no. Artikelnummer/ Modelo Número / статья НОМЕР	NM-Germany Article no.	NM-Germany Article no.	NM-Germany Article no.	NM-Germany Article no.	NM-Germany Article no.	NM-Germany Article no.	NM-Germany Article no.	
			<b>KBSAD40073G</b>	<b>KBAD40073G</b>	<b>KRAD40073G</b>			



ENGINE TYPE Motortyp Type de Moteur Tipo de motor Тип двигателя	LINER KIT Liner Kit Kit de Chemise Camisas de los cilindros лайнер комплект	CYL. LINER Zylinderlaufbuchse Chemise Camisas de los cilindros втулка цилиндра	PISTON + RINGS Kolben + Ringe Piston + Segments Pistón Set Поршень и кольца		PISTON SET Kolben Set Set de Piston Pistón Set поршневой	RINGS SET Kolben Set Segments de Piston Anillos Set кольца	PIN Pin Axe Perno Пин
<b>AAR</b> <b>NF</b> <b>NG</b> 5 Cyl 82.5 mm Bore Ø 2,309 cc		Length: Outside Ø: Flange Ø: flange depth	STD	O/S		Top: 1.5 2nd: 1.75 3rd: 3.0 1st oil: 2nd oil:	Ø: 20.0 Length: 57.0
			Length: 52.8	52.5			
			Comp: 32.2	31.9			
			Height: +1.1	+1.1			
			-4.4	-4.4			
			Reference no.:	Reference no.:	Reference no.:	Reference no.:	O-RING
			K-91513600 M-0348900 N-8799140020			G-0899140000 K-800001310000 M-03489N0	
NM-Germany Article no. Artikelnummer/ Modelo Número / статья НОМЕР	NM-Germany Article no.	NM-Germany Article no.	NM-Germany Article no.	NM-Germany Article no.	NM-Germany Article no.	NM-Germany Article no.	NM-Germany Article no.
			KBSAD50074G	KBAD50074G		KRAD50074G	

AUDI



**GASOLINE**

ENGINE TYPE Motortyp Type de Moteur Tipo de motor Тип двигателя	LINER KIT Liner Kit Kit de Chemise Camisas de los cilindros лайнер комплект	CYL. LINER Zylinderlaufbuchse Chemise Camisas de los cilindros втулка цилиндра	PISTON + RINGS Kolben + Ringe Piston + Segments Pistón Set Поршень и кольца		PISTON SET Kolben Set Set de Piston Pistón Set поршневой	RINGS SET Kolben Set Segments de Piston Anillos Set кольца	PIN Pin Axe Perno Пин
<b>AAH</b> <b>AEJ</b> <b>AFC</b> 6 Cyl 82.5 mm Bore Ø 2,771 cc		Length: Outside Ø: Flange Ø: flange depth	STD	O/S		Top: 1.2 2nd: 1.5 3rd: 2.0 1st oil: 2nd oil:	Ø: 21.0 Length: 56.0
			Length: 57.5	57.2			
			Comp: 30.8	30.5			
			Height: +0.7	+0.7			
			-4.6	-4.6			
			Reference no.:	Reference no.:	Reference no.:	Reference no.:	O-RING
			K-91532600 M-0349400 N-8750180010		078 107 065 T 078 107 081	A-R60310 G-0850180000 K-800001220000 K-800045720000 M-03031N0 M-03060N0 M-03075N0 M-03319N0 T-50018 T-50025	
NM-Germany Article no. Artikelnummer/ Modelo Número / статья НОМЕР	NM-Germany Article no.	NM-Germany Article no.	NM-Germany Article no.	NM-Germany Article no.	NM-Germany Article no.	NM-Germany Article no.	NM-Germany Article no.
			KBSAD60075G	KBAD60075G		KRAD60075G	

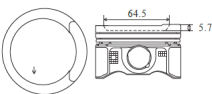

**GASOLINE**

ENGINE TYPE Motortyp Type de Moteur Tipo de motor Тип двигателя	LINER KIT Liner Kit Kit de Chemise Camisas de los cilindros лайнер комплект	CYL. LINER Zylinderlaufbuchse Chemise Camisas de los cilindros втулка цилиндра	PISTON + RINGS Kolben + Ringe Piston + Segments Pistón Set Поршень и кольца		PISTON SET Kolben Set Set de Piston Pistón Set поршневой	RINGS SET Kolben Set Segments de Piston Anillos Set кольца	PIN Pin Axe Perno Пин
<b>ABC</b> <b>ACZ</b> 6 Cyl 82.5 mm Bore Ø 2,597 cc		Length: Outside Ø: Flange Ø: flange depth	skirt MOS2 treated			Top: 1.5 2nd: 1.75 3rd: 3.0 1st oil: 2nd oil:	Ø: 21.0 Length: 56.0
			Length: 60.2				
			Comp: 33.5				
			Height: +0.7				
			-3.0				
			Reference no.:	Reference no.:	Reference no.:	Reference no.:	O-RING
			K-94492700 M-0349800 N-8799140010		078 107 065 K	G-0899140000 K-800001310000 M-03489N0	
NM-Germany Article no. Artikelnummer/ Modelo Número / статья НОМЕР	NM-Germany Article no.	NM-Germany Article no.	NM-Germany Article no.	NM-Germany Article no.	NM-Germany Article no.	NM-Germany Article no.	NM-Germany Article no.
			KBSAD60076G	KBAD60076G		KRAD60076G	

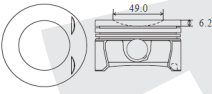

**GASOLINE**

ENGINE TYPE Motortyp Type de Moteur Tipo de motor Тип двигателя	LINER KIT Liner Kit Kit de Chemise Camisas de los cilindros лайнер комплект	CYL. LINER Zylinderlaufbuchse Chemise Camisas de los cilindros втулка цилиндра	PISTON + RINGS Kolben + Ringe Piston + Segments Pistón Set Поршень и кольца		PISTON SET Kolben Set Set de Piston Pistón Set поршневой	RINGS SET Kolben Set Segments de Piston Anillos Set кольца	PIN Pin Axe Perno Пин
<b>ADY AGG</b> 4 Cyl 82.5 mm Bore Ø 1,984 cc  		Length: Outside Ø: Flange Ø: flange depth	STD	O/S	skirt MOS2 treated	Top: 1.2	Ø: 21.0 Length: 56.0
			Length: 51.8	51.5		2nd: 1.5	
			Comp: 30.9	30.6		3rd: 2.0	
			Height: +0.9	+0.9	1st oil: 2.0		
			-5.7	-5.7	2nd oil:		
			Reference no.:	Reference no.:	Reference no.:	Reference no.:	O-RING
				<b>M-0303100 N-8750180020</b>		<b>A-R60310 G-0850180000 K-800001220000 K-800045720000 M-03031N0 M-03060N0 M-03075N0 M-03319N0 T-50018 T-50025</b>	
NM-Germany Article no. Artikelnummer/ Modelo Número / статья НОМЕР	NM-Germany Article no.	NM-Germany Article no.	NM-Germany Article no.	NM-Germany Article no.	NM-Germany Article no.	NM-Germany Article no.	NM-Germany Article no.
			<b>KBSAD40077G</b>	<b>KBAD40077G</b>	<b>KRAD40077G</b>		

**GASOLINE**

ENGINE TYPE Motortyp Type de Moteur Tipo de motor Тип двигателя	LINER KIT Liner Kit Kit de Chemise Camisas de los cilindros лайнер комплект	CYL. LINER Zylinderlaufbuchse Chemise Camisas de los cilindros втулка цилиндра	PISTON + RINGS Kolben + Ringe Piston + Segments Pistón Set Поршень и кольца		PISTON SET Kolben Set Set de Piston Pistón Set поршневой	RINGS SET Kolben Set Segments de Piston Anillos Set кольца	PIN Pin Axe Perno Пин
<b>AXX BWA</b> 4 Cyl 82.5 mm Bore Ø 1,998 cc  		Length: Outside Ø: Flange Ø: flange depth	Length: 50.6		alfin skirt MOS2 treated fits tapered con. rod	Top: 1.2	Ø: 20.0 Length: 59.0
			Comp: 29.6			2nd: 1.5	
			Height: -6.2			3rd: 2.0	
					1st oil: 2.0		
					2nd oil:		
			Reference no.:	Reference no.:	Reference no.:	Reference no.:	O-RING
				<b>06D 107 066 C 06D 107 104 C M-0332100</b>		<b>A-R60310 G-0850180000 K-800001220000 K-800045720000 M-03031N0 M-03060N0 M-03075N0 M-03319N0 T-50018 T-50025</b>	
NM-Germany Article no. Artikelnummer/ Modelo Número / статья НОМЕР	NM-Germany Article no.	NM-Germany Article no.	NM-Germany Article no.	NM-Germany Article no.	NM-Germany Article no.	NM-Germany Article no.	NM-Germany Article no.
			<b>KBSAD40078GA</b>	<b>KBAD40078GA</b>	<b>KRAD40078G</b>		

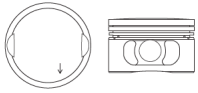
**GASOLINE**

ENGINE TYPE Motortyp Type de Moteur Tipo de motor Тип двигателя	LINER KIT Liner Kit Kit de Chemise Camisas de los cilindros лайнер комплект	CYL. LINER Zylinderlaufbuchse Chemise Camisas de los cilindros втулка цилиндра	PISTON + RINGS Kolben + Ringe Piston + Segments Pistón Set Поршень и кольца		PISTON SET Kolben Set Set de Piston Pistón Set поршневой	RINGS SET Kolben Set Segments de Piston Anillos Set кольца	PIN Pin Axe Perno Пин
<b>AGE/AMX APR/AQD/ATX</b> 6 Cyl 82.5 mm Bore Ø 2,771 cc  		Length: Outside Ø: Flange Ø: flange depth	STD	O/S		Top: 1.2	Ø: 21.0 Length: 56.0
			Length: 52.28	51.98		2nd: 1.5	
			Comp: 30.16	29.86		3rd: 2.0	
			Height: +1.12	+1.12	1st oil: 2.0		
					2nd oil:		
			Reference no.:	Reference no.:	Reference no.:	Reference no.:	O-RING
				<b>K-99942600 M-0332200</b>		<b>A-R60310 G-0850180000 K-800001220000 K-800045720000 M-03031N0 M-03060N0 M-03075N0 M-03319N0 T-50018 T-50025</b>	
NM-Germany Article no. Artikelnummer/ Modelo Número / статья НОМЕР	NM-Germany Article no.	NM-Germany Article no.	NM-Germany Article no.	NM-Germany Article no.	NM-Germany Article no.	NM-Germany Article no.	NM-Germany Article no.
			<b>KBSAD60079G</b>	<b>KBAD60079G</b>	<b>KRAD60079G</b>		



ENGINE TYPE	LINER KIT	CYL. LINER	PISTON + RINGS		PISTON SET	RINGS SET	PIN
Motor typ Type de Moteur Tipo de motor Тип двигателя	Liner Kit Kit de Chemise Camisas de los cilindros лайнер комплект	Zylinderlaufbuchse Chemise Camisas de los cilindros втулка цилиндра	Kolben + Ringe Piston + Segments Pistón Set Поршень и кольца		Kolben Set Set de Piston Pistón Set поршневой	Kolben Set Segments de Piston Anillos Set кольца	Pin Axe Perno Пин
<b>ATM/AZH/AZJ</b> <b>AZM/BEH/BEJ</b> 4 Cyl 82.5 mm Bore Ø 1,984 cc		Length: 51.0 Outside Ø: Flange Ø: flange depth	Length: 51.0 Comp: 29.3 Height: -5.0			Top: 1.2 2nd: 1.5 3rd: 2.0 1st oil: 2nd oil:	Ø: 19.0 Length: 42.0
			Reference no.:	Reference no.:	Reference no.:	Reference no.:	O-RING
				<b>M-0309200</b>	<b>06B 107 065 B</b> <b>06B 107 065 Q</b> <b>06B 107 103 B</b>	<b>A-R60310</b> <b>G-0850180000</b> <b>K-800001220000</b> <b>K-800045720000</b> <b>M-03031N0</b> <b>M-03060N0</b> <b>M-03075N0</b> <b>M-03319N0</b> <b>T-50018</b> <b>T-50025</b>	
NM-Germany Article no. Artikelnummer/ Modelo Número / статья НОМЕР	NM-Germany Article no.	NM-Germany Article no.	NM-Germany Article no.	NM-Germany Article no.	NM-Germany Article no.	NM-Germany Article no.	NM-Germany Article no.
			<b>KBSAD40080G</b>	<b>KBAD40080G</b>	<b>KRAD40080G</b>		

AUDI

GASOLINE							
ENGINE TYPE	LINER KIT	CYL. LINER	PISTON + RINGS		PISTON SET	RINGS SET	PIN
Motor typ Type de Moteur Tipo de motor Тип двигателя	Liner Kit Kit de Chemise Camisas de los cilindros лайнер комплект	Zylinderlaufbuchse Chemise Camisas de los cilindros втулка цилиндра	Kolben + Ringe Piston + Segments Pistón Set Поршень и кольца		Kolben Set Set de Piston Pistón Set поршневой	Kolben Set Segments de Piston Anillos Set кольца	Pin Axe Perno Пин
<b>ALT</b> 4 Cyl 82.51 mm Bore Ø 1,984 cc		Length: 50.6 Outside Ø: Flange Ø: flange depth	Length: 50.6 Comp: 29.6 Height: -2.6			Top: 1.2 2nd: 1.5 3rd: 2.0 1st oil: 2nd oil:	Ø: 19.0 Length: 44.0
			Reference no.:	Reference no.:	Reference no.:	Reference no.:	O-RING
				<b>M-0308300</b>	<b>06B 107 065 AA</b> <b>06B 107 065 AG</b> <b>06B 107 065 L</b>	<b>06C 198 151 B</b> <b>06D 107 301 A</b> <b>06D 198 151 A/B</b> <b>06F 198 151 A</b> <b>078 107 321 A</b> <b>A-R60310</b> <b>G-0850180000</b> <b>K-800001220000</b> <b>K-800045720000</b> <b>M-03031N0</b> <b>M-03060N0</b> <b>M-03075N0</b> <b>M-03319N0</b> <b>T-50018/25</b>	
NM-Germany Article no. Artikelnummer/ Modelo Número / статья НОМЕР	NM-Germany Article no.	NM-Germany Article no.	NM-Germany Article no.	NM-Germany Article no.	NM-Germany Article no.	NM-Germany Article no.	NM-Germany Article no.
			<b>KBSAD40081G</b>	<b>KBAD40081G</b>	<b>KRAD40081G</b>		

GASOLINE							
ENGINE TYPE	LINER KIT	CYL. LINER	PISTON + RINGS		PISTON SET	RINGS SET	PIN
Motor typ Type de Moteur Tipo de motor Тип двигателя	Liner Kit Kit de Chemise Camisas de los cilindros лайнер комплект	Zylinderlaufbuchse Chemise Camisas de los cilindros втулка цилиндра	Kolben + Ringe Piston + Segments Pistón Set Поршень и кольца		Kolben Set Set de Piston Pistón Set поршневой	Kolben Set Segments de Piston Anillos Set кольца	Pin Axe Perno Пин
<b>AAH</b> 6 Cyl 82.51 mm Bore Ø 2,771 cc		Length: 52.5 Outside Ø: Flange Ø: flange depth	Length: 52.5 Comp: 30.8 Height: -4.25	STD O/S		Top: 1.2 2nd: 1.5 3rd: 2.0 1st oil: 2nd oil:	Ø: 21.0 Length: 56.0
			Reference no.:	Reference no.:	Reference no.:	Reference no.:	O-RING
				<b>M-0349600</b> <b>N-8750180010</b>	<b>078 107 065 Q</b>	<b>A-R60310</b> <b>G-0850180000</b> <b>K-800001220000</b> <b>K-800045720000</b> <b>M-03031N0</b> <b>M-03060N0</b> <b>M-03075N0</b> <b>M-03319N0</b> <b>T-50018</b> <b>T-50025</b>	
NM-Germany Article no. Artikelnummer/ Modelo Número / статья НОМЕР	NM-Germany Article no.	NM-Germany Article no.	NM-Germany Article no.	NM-Germany Article no.	NM-Germany Article no.	NM-Germany Article no.	NM-Germany Article no.
			<b>KBSAD60082G</b>	<b>KBAD60082G</b>	<b>KRAD60082G</b>		

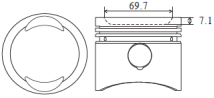
## GASOLINE

ENGINE TYPE Motortyp Type de Moteur Tipo de motor Тип двигателя	LINER KIT Liner Kit Kit de Chemise Camisas de los cilindros лайнер комплект	CYL. LINER Zylinderlaufbuchse Chemise Camisas de los cilindros втулка цилиндра	PISTON + RINGS Kolben + Ringe Piston + Segments Pistón Set Поршень и кольца			PISTON SET Kolben Set Set de Piston Pistón Set поршень	RINGS SET Kolben Set Segments de Piston Anillos Set кольца	PIN Pin Axe Perno Пин
<b>WA</b> <b>4 Cyl</b> <b>86.5 mm Bore Ø</b> <b>1,984 cc</b>		Length: Outside Ø: Flange Ø: flange depth	Length: 77.7 Comp: 40.7 Height: -7.1			Top: 2.0 2nd: 2.5 3rd: 5.0 1st oil: 2nd oil:	Ø: 24.0 Length: 73.0	
								Reference no.:
			<b>K-92870600</b> <b>M-0346900</b>			<b>G-0839970010</b> <b>K-800001440000</b> <b>M-03469N0</b>		
NM-Germany Article no. Artikelnummer/ Modelo Número / статья НОМЕР	NM-Germany Article no.	NM-Germany Article no.	NM-Germany Article no.	NM-Germany Article no.	NM-Germany Article no.	NM-Germany Article no.	NM-Germany Article no.	
			<b>KBSAD40083G</b>	<b>KBAD40083G</b>	<b>KRAD40083G</b>			

**GASOLINE**

ENGINE TYPE Motortyp Type de Moteur Tipo de motor Тип двигателя	LINER KIT Liner Kit Kit de Chemise Camisas de los cilindros лайнер комплект	CYL. LINER Zylinderlaufbuchse Chemise Camisas de los cilindros втулка цилиндра	PISTON + RINGS Kolben + Ringe Piston + Segments Pistón Set Поршень и кольца			PISTON SET Kolben Set Set de Piston Pistón Set поршневой	RINGS SET Kolben Set Segments de Piston Anillos Set кольца	PIN Pin Axe Perno Пин
<b>A SERIES A+ SERIES</b> 4 Cyl 64.56 mm Bore Ø 999 cc		Length: Outside Ø: Flange Ø: flange depth	Length: 65.77 Comp: 34.09 Height: -4.9			Top: 1.588	Ø: 15.867 Length: 55.5	
						2nd: 1.588		
						3rd: 1.588		
					1st oil: 4.0 2nd oil:			
		<b>Reference no.:</b>	<b>Reference no.:</b>	<b>Reference no.:</b>	<b>Reference no.:</b>	<b>O-RING</b>		
			<b>A-20773 K-91561600 M-0253200 N-8752240000</b>		<b>A-R33636 G-0852240000</b>			
NM-Germany Article no. Artikelnummer/ Modelo Número / статья НОМЕР	NM-Germany Article no.	NM-Germany Article no.	NM-Germany Article no.	NM-Germany Article no.	NM-Germany Article no.	NM-Germany Article no.	NM-Germany Article no.	
			<b>KBSAM40084G</b>	<b>KBAM40084G</b>	<b>KRAM40084G</b>			

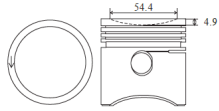

**GASOLINE**

ENGINE TYPE Motortyp Type de Moteur Tipo de motor Тип двигателя	LINER KIT Liner Kit Kit de Chemise Camisas de los cilindros лайнер комплект	CYL. LINER Zylinderlaufbuchse Chemise Camisas de los cilindros втулка цилиндра	PISTON + RINGS Kolben + Ringe Piston + Segments Pistón Set Поршень и кольца			PISTON SET Kolben Set Set de Piston Pistón Set поршневой	RINGS SET Kolben Set Segments de Piston Anillos Set кольца	PIN Pin Axe Perno Пин
<b>A SERIES</b> 4 Cyl 64.56 mm Bore Ø 1,098 cc		Length: Outside Ø: Flange Ø: flange depth	Length: 58.05 Comp: 30.33 Height: -5.3			Top: 1.60	Ø: 15.867 Length: 55.5	
						2nd: 1.588		
						3rd: 1.588		
					1st oil: 3.175 2nd oil:			
		<b>Reference no.:</b>	<b>Reference no.:</b>	<b>Reference no.:</b>	<b>Reference no.:</b>	<b>O-RING</b>		
			<b>A-20397V1 K-91028600 M-0411400 N-8752230700</b>		<b>A-R32026 G-0852230000</b>			
NM-Germany Article no. Artikelnummer/ Modelo Número / статья НОМЕР	NM-Germany Article no.	NM-Germany Article no.	NM-Germany Article no.	NM-Germany Article no.	NM-Germany Article no.	NM-Germany Article no.	NM-Germany Article no.	
			<b>KBSAM40085G</b>	<b>KBAM40085G</b>	<b>KRAM40085G</b>			

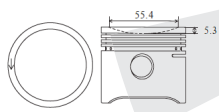



AUSTIN-MORRIS

**GASOLINE**

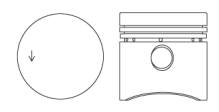

ENGINE TYPE Motortyp Type de Moteur Tipo de motor Тип двигателя	LINER KIT Liner Kit Kit de Chemise Camisas de los cilindros лайнер комплект	CYL. LINER Zylinderlaufbuchse Chemise Camisas de los cilindros втулка цилиндра	PISTON + RINGS Kolben + Ringe Piston + Segments Pistón Set Поршень и кольца			PISTON SET Kolben Set Set de Piston Pistón Set поршневой	RINGS SET Kolben Set Segments de Piston Anillos Set кольца	PIN Pin Axe Perno Пин
<b>A SERIES</b> 4 Cyl 65.58 mm Bore Ø 999 cc		Length: Outside Ø: Flange Ø: flange depth	Length: 65.77 Comp: 34.09 Height: 0			Top: 1.6	Ø: 15.867 Length: 55.5	
						2nd: 1.6		
						3rd: 3.18		
					1st oil: 2nd oil:			
		<b>Reference no.:</b>	<b>Reference no.:</b>	<b>Reference no.:</b>	<b>Reference no.:</b>	<b>O-RING</b>		
NM-Germany Article no. Artikelnummer/ Modelo Número / статья НОМЕР	NM-Germany Article no.	NM-Germany Article no.	NM-Germany Article no.	NM-Germany Article no.	NM-Germany Article no.	NM-Germany Article no.	NM-Germany Article no.	
			<b>KBSAM40086G</b>	<b>KBAM40086G</b>	<b>KRAM40086G</b>			

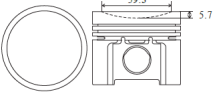

**GASOLINE**

ENGINE TYPE Motortyp Type de Moteur Tipo de motor Тип двигателя	LINER KIT Liner Kit Kit de Chemise Camisas de los cilindros лайнер комплект	CYL. LINER Zylinderlaufbuchse Chemise Camisas de los cilindros втулка цилиндра	PISTON + RINGS Kolben + Ringe Piston + Segments Pistón Set Поршень и кольца			PISTON SET Kolben Set Set de Piston Pistón Set поршневой	RINGS SET Kolben Set Segments de Piston Anillos Set кольца	PIN Pin Axe Perno Пин
<b>A SERIES</b> <b>A+ SERIES</b> 4 Cyl 70.62 mm Bore Ø 1,071 cc 1,275 cc		Length:		Length:	58.74	Top: 1.5 2nd: 1.5 3rd: 1st oil: 3.0 2nd oil:	Ø: 20.638  Length: 55.2	
		Outside Ø:	141.28	Comp:	38.8			
		Flange Ø:	73.09	Height:	-5.7			
		flange depth						
		Reference no.:		Reference no.:		Reference no.:		O-RING
		A-SU3598 G-1401089000		A-21253 N-8752410000		A-R41570 G-0852410000		
								
NM-Germany Article no. Artikelnummer/ Modelo Número / статья НОМЕР	NM-Germany Article no.	NM-Germany Article no.	NM-Germany Article no.	NM-Germany Article no.	NM-Germany Article no.	NM-Germany Article no.	NM-Germany Article no.	NM-Germany Article no.
	LBSAM40087GP	LBAM40087GP	KBSAM40087G	KBAM40087G	KRAM40087G			

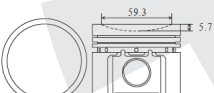
**GASOLINE**

ENGINE TYPE Motortyp Type de Moteur Tipo de motor Тип двигателя	LINER KIT Liner Kit Kit de Chemise Camisas de los cilindros лайнер комплект	CYL. LINER Zylinderlaufbuchse Chemise Camisas de los cilindros втулка цилиндра	PISTON + RINGS Kolben + Ringe Piston + Segments Pistón Set Поршень и кольца			PISTON SET Kolben Set Set de Piston Pistón Set поршневой	RINGS SET Kolben Set Segments de Piston Anillos Set кольца	PIN Pin Axe Perno Пин
<b>A SERIES</b> 4 Cyl 73.0 mm Bore Ø 1,275 cc		Length:		Length:	58.74	Top: 1.5 2nd: 1.5 3rd: 1st oil: 4.0 2nd oil:	Ø: 20.638  Length: 55.2	
		Outside Ø:		Comp:	38.8			
		Flange Ø:		Height:	-5.7			
		flange depth						
		Reference no.:		Reference no.:		Reference no.:		O-RING
								
NM-Germany Article no. Artikelnummer/ Modelo Número / статья НОМЕР	NM-Germany Article no.	NM-Germany Article no.	NM-Germany Article no.	NM-Germany Article no.	NM-Germany Article no.	NM-Germany Article no.	NM-Germany Article no.	NM-Germany Article no.
			KBSAM40088G	KBAM40088G	KRAM40088G			

**DIESEL**

ENGINE TYPE Motortyp Type de Moteur Tipo de motor Тип двигателя	LINER KIT Liner Kit Kit de Chemise Camisas de los cilindros лайнер комплект	CYL. LINER Zylinderlaufbuchse Chemise Camisas de los cilindros штулка цилиндра	PISTON + RINGS Kolben + Ringe Piston + Segments Pistón Set Поршень и кольца	PISTON SET Kolben Set Set de Piston Pistón Set поршневой	RINGS SET Kolben Set Segments de Piston Anillos Set кольца	PIN Pin Axe Perno Пин
<b>21.5</b> <b>J 330</b>  <b>4/6 Cyl</b> <b>103.18 mm Bore Ø</b> <b>3,614 cc 5,407cc</b>	<b>K-93918971</b> <b>M-0691880</b>	Length: 216.3 Outside Ø: 107.95 Flange Ø: 111.13 flange depth 4.76	Length: 118.2 Comp: 71.5 Height: -16.5 -21.5		Top: 2.385 2nd: 2.39 3rd: 2.39 1st oil: 4.747 2nd oil: 4.747	Ø: 34.92 Length: 87.9
		<b>Reference no.:</b> <b>7191818</b> <b>A-SU497301</b> <b>K-88041190</b> <b>M-069WV03</b> <b>G-1402114000</b>	<b>Reference no.:</b> <b>A-350083V1</b> <b>K-93918700</b> <b>M-0691810</b> <b>N-8712630010</b>	<b>Reference no.:</b> <b>2716937</b>	<b>Reference no.:</b> <b>2716607</b> <b>A-R40150</b> <b>K-800001510000</b> <b>G-0812630010</b>	<b>O-RING</b>
NM-Germany Article no. Artikelnummer/ Modelo Número / статья НОМЕР	NM-Germany Article no.	NM-Germany Article no.	NM-Germany Article no.	NM-Germany Article no.	NM-Germany Article no.	NM-Germany Article no.
	<b>LBSBD0089DS</b>	<b>LBBD0089DS</b>	<b>KBSBD0089D</b>	<b>KBBD0089D</b>	<b>KRBD0089D</b>	

## DIESEL

ENGINE TYPE Motortyp Type de Moteur Tipo de motor Тип двигателя	LINER KIT Liner Kit Kit de Chemise Camisas de los cilindros лайнер комплект	CYL. LINER Zylinderlaufbuchse Chemise Camisas de los cilindros втулка цилиндра	PISTON + RINGS Kolben + Ringe Piston + Segments Pistón Set Поршень и кольца		PISTON SET Kolben Set Set de Piston Pistón Set поршневой	RINGS SET Kolben Set Segments de Piston Anillos Set кольца	PIN Pin Axe Perno Пин	
<b>M21D24 TURBO</b> <b>6 Cyl</b> <b>80.0 mm Bore Ø</b> <b>2,443 cc</b>		Length: Outside Ø: Flange Ø: flange depth	Length: Comp: Height:	79.3 46.5 -2.0	alfin	Top: double key-stone 2nd: 3rd: 1st oil: 2nd oil:	Ø: Length:	
								26.0 69.0
								2.5 2.0 3.5
			Reference no.:	Reference no.:	Reference no.:	Reference no.:	O-RING	
				<b>K-93895600</b> <b>M-0817000</b>	<b>11 25 1 285 738</b> <b>11 25 1 285 740</b> <b>11 25 2 240 204</b>	<b>11 25 1 287 118</b> <b>11 25 2 241 225</b> <b>G-0813310010</b> <b>K-800001760000</b> <b>M-08169N0</b>		
NM-Germany Article no. Artikelnummer/ Modelo Número / статья HOMEP	NM-Germany Article no.	NM-Germany Article no.	NM-Germany Article no.	NM-Germany Article no.	NM-Germany Article no.	NM-Germany Article no.	NM-Germany Article no.	
			<b>KBSBM60094DA</b>	<b>KBBM60094DA</b>	<b>KRBM60094DA</b>			

## DIESEL

ENGINE TYPE Motortyp Type de Moteur Tipo de motor Тип двигателя	LINER KIT Liner Kit Kit de Chemise Camisas de los cilindros лайнер комплект	CYL. LINER Zylinderlaufbuchse Chemise Camisas de los cilindros втулка цилиндра	PISTON + RINGS Kolben + Ringe Piston + Segments Pistón Set Поршень и кольца		PISTON SET Kolben Set Set de Piston Pistón Set поршневой	RINGS SET Kolben Set Segments de Piston Anillos Set кольца	PIN Pin Axe Perno Пин	
<b>M41D18 TURBO</b> <b>M51D25 TURBO</b> <b>4/6 Cyl</b> <b>80.0 mm Bore Ø</b> <b>1,669 cc 2,498 cc</b>		Length: 143.0 Outside Ø: 84.0 Flange Ø: 85.0 flange depth 4.8	Length: 62.4 Comp: 39.4 Height: -2.5		alfin and with oil gallery top ring land and skirt MOS2 treated	Top: double key-stone 2nd: 3rd: 1st oil: 2nd oil:	Ø: Length:	
								27.0 63.0
								3.0 1.75 3.0
			Reference no.:	Reference no.:	Reference no.:	Reference no.:	O-RING	
				<b>K-94347600</b> <b>M-0826200</b> <b>N-8770450000</b>	<b>11 25 2 243 385</b> <b>11 25 2 246 629</b>	<b>11 25 2 243 860</b> <b>A-R49900</b> <b>G-0870450000</b> <b>K-800030120000</b> <b>M-08262N0</b>		
NM-Germany Article no. Artikelnummer/ Modelo Número / статья HOMEP	NM-Germany Article no.	NM-Germany Article no.	NM-Germany Article no.	NM-Germany Article no.	NM-Germany Article no.	NM-Germany Article no.	NM-Germany Article no.	
	<b>LBSBM460095DSB</b>	<b>LBBM460095DSB</b>	<b>KBSBM460095DB</b>	<b>KBBM460095DB</b>	<b>KRBM460095DB</b>			

## DIESEL

ENGINE TYPE Motortyp Type de Moteur Tipo de motor Тип двигателя	LINER KIT Liner Kit Kit de Chemise Camisas de los cilindros лайнер комплект	CYL. LINER Zylinderlaufbuchse Chemise Camisas de los cilindros втулка цилиндра	PISTON + RINGS Kolben + Ringe Piston + Segments Pistón Set Поршень и кольца		PISTON SET Kolben Set Set de Piston Pistón Set поршневой	RINGS SET Kolben Set Segments de Piston Anillos Set кольца	PIN Pin Axe Perno Пин	
<b>M21D25 TURBO</b> <b>6 Cyl</b> <b>80.0 mm Bore Ø</b> <b>2,443 cc</b>		Length: 76.3 Outside Ø: Flange Ø: flange depth	Length: 76.3 Comp: 46.4 Height: -2.0	STD O/S 76.3 76.3 46.4 46.2 -2.0 -0.5 -0.5 -2.0	alfin and with oil gallery	Top: double keystone 2nd: 3rd: 1st oil: 2nd oil:	Ø: Length:	
								26.0 69.0
								2.5 2.0 3.5
			Reference no.:	Reference no.:	Reference no.:	Reference no.:	O-RING	
				<b>K-93579600</b> <b>M-0816900</b> <b>N-8713310000</b>	<b>11 25 1 279 185</b> <b>11 25 1 279 190</b>	<b>11 25 1 287 118</b> <b>11 25 2 241 225</b> <b>G-0813310010</b> <b>K-800001760000</b> <b>M-08169N0</b>		
NM-Germany Article no. Artikelnummer/ Modelo Número / статья HOMEP	NM-Germany Article no.	NM-Germany Article no.	NM-Germany Article no.	NM-Germany Article no.	NM-Germany Article no.	NM-Germany Article no.	NM-Germany Article no.	
			<b>KBSBM60096DB</b>	<b>KBBM60096DB</b>	<b>KRBM60096DB</b>			



**DIESEL**

ENGINE TYPE Motortyp Type de Moteur Tipo de motor Тип двигателя	LINER KIT Liner Kit Kit de Chemise Camisas de los cilindros лайнер комплект	CYL. LINER Zylinderlaufbuchse Chemise Camisas de los cilindros втулка цилиндра	PISTON + RINGS Kolben + Ringe Piston + Segments Pistón Set Поршень и кольца			PISTON SET Kolben Set Set de Piston Pistón Set поршневой	RINGS SET Kolben Set Segments de Piston Anillos Set кольца	PIN Pin Axe Perno Пин					
<b>M57D25</b> 6 Cyl 80.0 mm Bore Ø 2,497 cc		Length: Outside Ø: Flange Ø: flange depth	Length: Comp: Height:	72.47 46.97 -1.0	alfin and with oil gallery skirt MOS2 treated	Top: 2nd: 3rd: 1st oil: 2nd oil:	2.5 2.0 3.0	Ø: 30.0 Length: 60.0					
									Reference no.:	Reference no.:	Reference no.:	Reference no.:	O-RING
										<b>M-0831100</b>	<b>11 25 7 786 451</b>	<b>M-08311N0</b>	
NM-Germany Article no. Artikelnummer/ Modelo Número / статья НОМЕР	NM-Germany Article no.	NM-Germany Article no.	NM-Germany Article no.	NM-Germany Article no.	NM-Germany Article no.	NM-Germany Article no.	NM-Germany Article no.						
			<b>KBSBM60097DB</b>	<b>KBBM60097DB</b>	<b>KRBM60097DB</b>								

**GASOLINE**

ENGINE TYPE Motortyp Type de Moteur Tipo de motor Тип двигателя	LINER KIT Liner Kit Kit de Chemise Camisas de los cilindros лайнер комплект	CYL. LINER Zylinderlaufbuchse Chemise Camisas de los cilindros втулка цилиндра	PISTON + RINGS Kolben + Ringe Piston + Segments Pistón Set Поршень и кольца			PISTON SET Kolben Set Set de Piston Pistón Set поршневой	RINGS SET Kolben Set Segments de Piston Anillos Set кольца	PIN Pin Axe Perno Пин					
<b>M20B23 E</b> 6 Cyl 80.0 mm Bore Ø 2,315 cc		Length: Outside Ø: Flange Ø: flange depth	Length: Comp: Height:	70.6 37.8 -1.3		Top: 2nd: 3rd: 1st oil: 2nd oil:	1.5 2.0 3.5	Ø: 22.0 Length: 60.9					
									Reference no.:	Reference no.:	Reference no.:	Reference no.:	O-RING
										<b>K-93048600</b> <b>M-0817600</b>	<b>11 25 1 264 973</b> <b>11 25 1 264 991</b> <b>11 25 1 273 730</b>	<b>11 25 1 267 575</b> <b>11 25 1 267 743</b> <b>11 25 1 714 846</b> <b>A-R45870</b> <b>G-0813130000</b> <b>K-800001661000</b> <b>M-08176N0</b>	
NM-Germany Article no. Artikelnummer/ Modelo Número / статья НОМЕР	NM-Germany Article no.	NM-Germany Article no.	NM-Germany Article no.	NM-Germany Article no.	NM-Germany Article no.	NM-Germany Article no.	NM-Germany Article no.						
			<b>KBSBM60098G</b>	<b>KBBM60098G</b>	<b>KRBM60098G</b>								

**GASOLINE**

ENGINE TYPE Motortyp Type de Moteur Tipo de motor Тип двигателя	LINER KIT Liner Kit Kit de Chemise Camisas de los cilindros лайнер комплект	CYL. LINER Zylinderlaufbuchse Chemise Camisas de los cilindros втулка цилиндра	PISTON + RINGS Kolben + Ringe Piston + Segments Pistón Set Поршень и кольца			PISTON SET Kolben Set Set de Piston Pistón Set поршневой	RINGS SET Kolben Set Segments de Piston Anillos Set кольца	PIN Pin Axe Perno Пин					
<b>M20B20 L</b> <b>M20B20 M</b> <b>M20B20 V</b> 6 Cyl 80.0 mm Bore Ø 1,991 cc		Length: Outside Ø: Flange Ø: flange depth	Length: Comp: Height:	70.5 43.4 2.1		Top: 2nd: 3rd: 1st oil: 2nd oil:	1.5 2.0 3.5	Ø: 22.0 Length: 61.0					
									Reference no.:	Reference no.:	Reference no.:	Reference no.:	O-RING
										<b>K-92985600</b> <b>M-0817500</b>	<b>11 25 1 264 967</b> <b>11 25 1 264 968</b>	<b>11 25 1 267 575</b> <b>11 25 1 267 743</b> <b>11 25 1 714 846</b> <b>A-R45870</b> <b>G-0813130000</b> <b>K-800001661000</b> <b>M-08176N0</b>	
NM-Germany Article no. Artikelnummer/ Modelo Número / статья НОМЕР	NM-Germany Article no.	NM-Germany Article no.	NM-Germany Article no.	NM-Germany Article no.	NM-Germany Article no.	NM-Germany Article no.	NM-Germany Article no.						
			<b>KBSBM60099G</b>	<b>KBBM60099G</b>	<b>KRBM60099G</b>								

## GASOLINE

ENGINE TYPE Motortyp Type de Moteur Tipo de motor Тип двигателя	LINER KIT Liner Kit Kit de Chemise Camisas de los cilindros лайнер комплект	CYL. LINER Zylinderlaufbuchse Chemise Camisas de los cilindros втулка цилиндра	PISTON + RINGS Kolben + Ringe Piston + Segments Pistón Set Поршень и кольца			PISTON SET Kolben Set Set de Piston Pistón Set поршневой	RINGS SET Kolben Set Segments de Piston Anillos Set кольца	PIN Pin Axe Perno Пин				
<b>M50B20 M</b> 6 Cyl 80.0 mm Bore Ø 1,991 cc		Length: Outside Ø: Flange Ø: flange depth	Length: Comp: Height: -3.15	62.4 42.4 -1.0		Top: 1.5 2nd: 1.75 3rd: 3.0 1st oil: 2nd oil:	Ø: 22.0 Length: 54.0					
								Reference no.:	Reference no.:	Reference no.:	Reference no.:	O-RING
									<b>K-91542600</b> <b>M-0827000</b>	<b>11 25 1 722 503</b> <b>11 25 1 722 508</b>	<b>11 25 1 726 711</b> <b>M-08273N0</b>	
NM-Germany Article no. Artikelnummer/ Modelo Número / статья НОМЕР	NM-Germany Article no.	NM-Germany Article no.	NM-Germany Article no.	NM-Germany Article no.	NM-Germany Article no.	NM-Germany Article no.	NM-Germany Article no.					
			<b>KBSBM60100G</b>	<b>KBBM60100G</b>	<b>KRBM60100G</b>							

## GASOLINE

ENGINE TYPE Motortyp Type de Moteur Tipo de motor Тип двигателя	LINER KIT Liner Kit Kit de Chemise Camisas de los cilindros лайнер комплект	CYL. LINER Zylinderlaufbuchse Chemise Camisas de los cilindros втулка цилиндра	PISTON + RINGS Kolben + Ringe Piston + Segments Pistón Set Поршень и кольца			PISTON SET Kolben Set Set de Piston Pistón Set поршневой	RINGS SET Kolben Set Segments de Piston Anillos Set кольца	PIN Pin Axe Perno Пин				
<b>M20B20 K</b> <b>M20B20 LE</b> 6 Cyl 80.0 mm Bore Ø 1,991 cc		Length: Outside Ø: Flange Ø: flange depth	Length: Comp: Height: -1.5	71.7 43.4 3.3		Top: 1.5 2nd: 2.0 3rd: 3.5 1st oil: 2nd oil:	Ø: 22.0 Length: 61.0					
								Reference no.:	Reference no.:	Reference no.:	Reference no.:	O-RING
									<b>K-93435600</b> <b>M-0817700</b> <b>N-8713130000</b>	<b>11 25 1 276 669</b> <b>11 25 1 276 734</b> <b>11 25 1 286 552</b> <b>11 25 1 287 048</b>	<b>11 25 1 267 575</b> <b>11 25 1 267 743</b> <b>11 25 1 714 846</b> <b>A-R45870</b> <b>G-0813130000</b> <b>K-800001661000</b> <b>M-08176N0</b>	
NM-Germany Article no. Artikelnummer/ Modelo Número / статья НОМЕР	NM-Germany Article no.	NM-Germany Article no.	NM-Germany Article no.	NM-Germany Article no.	NM-Germany Article no.	NM-Germany Article no.	NM-Germany Article no.					
			<b>KBSBM60101G</b>	<b>KBBM60101G</b>	<b>KRBM60101G</b>							

## GASOLINE

ENGINE TYPE Motortyp Type de Moteur Tipo de motor Тип двигателя	LINER KIT Liner Kit Kit de Chemise Camisas de los cilindros лайнер комплект	CYL. LINER Zylinderlaufbuchse Chemise Camisas de los cilindros втулка цилиндра	PISTON + RINGS Kolben + Ringe Piston + Segments Pistón Set Поршень и кольца			PISTON SET Kolben Set Set de Piston Pistón Set поршневой	RINGS SET Kolben Set Segments de Piston Anillos Set кольца	PIN Pin Axe Perno Пин				
<b>M50B20</b> 6 Cyl 80.0 mm Bore Ø 1,991 cc		Length: Outside Ø: Flange Ø: flange depth	Length: Comp: Height: -3.4	62.8 42.8 -1.6		Top: 1.5 2nd: 1.75 3rd: 3.0 1st oil: 2nd oil:	Ø: 22.0 Length: 54.0					
								Reference no.:	Reference no.:	Reference no.:	Reference no.:	O-RING
									<b>K-94475600</b> <b>M-0827300</b>	<b>11 25 1 735 580</b> <b>11 25 1 738 029</b>	<b>11 25 1 726 711</b> <b>M-08273N0</b>	
NM-Germany Article no. Artikelnummer/ Modelo Número / статья НОМЕР	NM-Germany Article no.	NM-Germany Article no.	NM-Germany Article no.	NM-Germany Article no.	NM-Germany Article no.	NM-Germany Article no.	NM-Germany Article no.					
			<b>KBSBM60102G</b>	<b>KBBM60102G</b>	<b>KRBM60102G</b>							

**GASOLINE**

ENGINE TYPE Motortyp Type de Moteur Tipo de motor Тип двигателя	LINER KIT Liner Kit Kit de Chemise Camisas de los cilindros лайнер комплект	CYL. LINER Zylinderlaufbuchse Chemise Camisas de los cilindros втулка цилиндра	PISTON + RINGS Kolben + Ringe Piston + Segments Pistón Set Поршень и кольца			PISTON SET Kolben Set Set de Piston Pistón Set поршневой	RINGS SET Kolben Set Segments de Piston Anillos Set кольца	PIN Pin Axe Perno Пин
<b>M50B20 M50B20 TU1</b> 6 Cyl 80.0 mm Bore Ø 1,991 cc		Length: Outside Ø: Flange Ø: flange depth	Length:	51.0		Top: 1.5 2nd: 1.5 3rd: 1.5 1st oil: 2.0 2nd oil:	Ø: 22.0 Length: 51.0	
			Comp:	31.64				
			Height:	1.86				
		flange depth		-2.94				
		Reference no.:	Reference no.:	Reference no.:	Reference no.:	O-RING		
			<b>K-94474600</b> <b>M-0826700</b> <b>N-8770500000</b>	<b>11 25 1 738 747</b> <b>11 25 1 740 610</b> <b>11 25 1 748 335</b>	<b>11 25 1 738 767</b> <b>A-R66470</b> <b>M-08267N0</b> <b>G-0870500000</b>			
NM-Germany Article no. Artikelnummer/ Modelo Número / статья НОМЕР	NM-Germany Article no.	NM-Germany Article no.	NM-Germany Article no.	NM-Germany Article no.	NM-Germany Article no.	NM-Germany Article no.	NM-Germany Article no.	
			<b>KBSBM60103G</b>	<b>KBBM60103G</b>	<b>KRBM60103G</b>			

**GASOLINE**

ENGINE TYPE Motortyp Type de Moteur Tipo de motor Тип двигателя	LINER KIT Liner Kit Kit de Chemise Camisas de los cilindros лайнер комплект	CYL. LINER Zylinderlaufbuchse Chemise Camisas de los cilindros втулка цилиндра	PISTON + RINGS Kolben + Ringe Piston + Segments Pistón Set Поршень и кольца			PISTON SET Kolben Set Set de Piston Pistón Set поршневой	RINGS SET Kolben Set Segments de Piston Anillos Set кольца	PIN Pin Axe Perno Пин
<b>M52B20</b> 6 Cyl 80.0 mm Bore Ø 1,991 cc		Length: Outside Ø: Flange Ø: flange depth	Length:	51.3		Top: 1.5 2nd: 1.5 3rd: 1.5 1st oil: 2.0 2nd oil:	Ø: 22.0 Length: 51.0	
			Comp:	31.7				
			Height:	2.1				
		flange depth		-3.0				
		Reference no.:	Reference no.:	Reference no.:	Reference no.:	O-RING		
			<b>M-0830400</b>	<b>11 25 1 437 146</b> <b>11 25 1 437 147</b>	<b>11 25 1 738 767</b> <b>M-08267N0</b> <b>G-0870500000</b>			
NM-Germany Article no. Artikelnummer/ Modelo Número / статья НОМЕР	NM-Germany Article no.	NM-Germany Article no.	NM-Germany Article no.	NM-Germany Article no.	NM-Germany Article no.	NM-Germany Article no.	NM-Germany Article no.	
			<b>KBSBM60104G</b>	<b>KBBM60104G</b>	<b>KRBM60104G</b>			

**GASOLINE**

ENGINE TYPE Motortyp Type de Moteur Tipo de motor Тип двигателя	LINER KIT Liner Kit Kit de Chemise Camisas de los cilindros лайнер комплект	CYL. LINER Zylinderlaufbuchse Chemise Camisas de los cilindros втулка цилиндра	PISTON + RINGS Kolben + Ringe Piston + Segments Pistón Set Поршень и кольца			PISTON SET Kolben Set Set de Piston Pistón Set поршневой	RINGS SET Kolben Set Segments de Piston Anillos Set кольца	PIN Pin Axe Perno Пин
<b>N52B25 OL</b> <b>N52B25 UL</b> 6 Cyl 82.0 mm Bore Ø 2,497 cc		Length: Outside Ø: Flange Ø: flange depth	Length:	50.3	head anodized fits tapered con. rod	Top: 1.2 2nd: 1.5 3rd: 1.5 1st oil: 2.0 2nd oil:	Ø: 20.0 Length: 46.0	
			Comp:	27.55				
			Height:	3.8				
		flange depth						
		Reference no.:	Reference no.:	Reference no.:	Reference no.:	O-RING		
			<b>K-40407600</b>					
NM-Germany Article no. Artikelnummer/ Modelo Número / статья НОМЕР	NM-Germany Article no.	NM-Germany Article no.	NM-Germany Article no.	NM-Germany Article no.	NM-Germany Article no.	NM-Germany Article no.	NM-Germany Article no.	
			<b>KBSBM60105G</b>	<b>KBBM60105G</b>	<b>KRBM60105G</b>			

## DIESEL

ENGINE TYPE Motortyp Type de Moteur Tipo de motor Тип двигателя	LINER KIT Liner Kit Kit de Chemise Camisas de los cilindros лайнер комплект	CYL. LINER Zylinderlaufbuchse Chemise Camisas de los cilindros втулка цилиндра	PISTON + RINGS Kolben + Ringe Piston + Segments Pistón Set Поршень и кольца			PISTON SET Kolben Set Set de Piston Pistón Set поршневой	RINGS SET Kolben Set Segments de Piston Anillos Set кольца	PIN Pin Axe Perno Пин
<b>M47D20 TURBO</b> 4 Cyl 84.0 mm Bore Ø 1,951 cc		Length: 152.0 Outside Ø: 87.0 Flange Ø: 90.0 flange depth 4.5	Length: 70.8 Comp: 47.0 Height: -2.5 -15.0		alfin and with oil gallery skirt MOS2 treated	Top: 3.0 double key-stone	Ø: 30.0 Length: 68.0	
						2nd: 2.0 3rd: 2.0 1st oil: 3.0 2nd oil:		
		Reference no.:	Reference no.:	Reference no.:	Reference no.:	O-RING		
			<b>M-0831700</b> <b>N-8711440000</b>			<b>11 25 7 787 083</b> <b>A-R60220</b> <b>G-0811440000</b> <b>M-08318N0</b>		
NM-Germany Article no. Artikelnummer/ Modelo Número / статья НОМЕР	NM-Germany Article no.	NM-Germany Article no.	NM-Germany Article no.	NM-Germany Article no.	NM-Germany Article no.	NM-Germany Article no.	NM-Germany Article no.	
	<b>LBSBM40106DSB</b>	<b>LBBM40106DSB</b>	<b>KBSBM40106DB</b>	<b>KBBM40106DB</b>	<b>KRBM40106DB</b>			

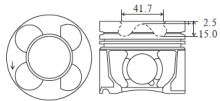

## DIESEL

ENGINE TYPE Motortyp Type de Moteur Tipo de motor Тип двигателя	LINER KIT Liner Kit Kit de Chemise Camisas de los cilindros лайнер комплект	CYL. LINER Zylinderlaufbuchse Chemise Camisas de los cilindros втулка цилиндра	PISTON + RINGS Kolben + Ringe Piston + Segments Pistón Set Поршень и кольца			PISTON SET Kolben Set Set de Piston Pistón Set поршневой	RINGS SET Kolben Set Segments de Piston Anillos Set кольца	PIN Pin Axe Perno Пин
<b>M57D30 TURBO</b> 6 Cyl 84.0 mm Bore Ø 2,926 cc		Length: 152.0 Outside Ø: 87.0 Flange Ø: 90.0 flange depth 4.5	Length: 70.8 Comp: 47.0 Height: -5.9 -16.5		alfin and with oil gallery skirt MOS2 treated	Top: 3.0 double key-stone	Ø: 30.0 Length: 68.0	
						2nd: 2.0 3rd: 2.0 1st oil: 3.0 2nd oil:		
		Reference no.:	Reference no.:	Reference no.:	Reference no.:	O-RING		
			<b>M-0831800</b> <b>N-8711440010</b>			<b>11 25 7 787 083</b> <b>A-R60220</b> <b>G-0811440000</b> <b>M-08318N0</b>		
NM-Germany Article no. Artikelnummer/ Modelo Número / статья НОМЕР	NM-Germany Article no.	NM-Germany Article no.	NM-Germany Article no.	NM-Germany Article no.	NM-Germany Article no.	NM-Germany Article no.	NM-Germany Article no.	
	<b>LBSBM60107DSB</b>	<b>LBBM60107DSB</b>	<b>KBSBM60107DB</b>	<b>KBBM60107DB</b>	<b>KRBM60107DB</b>			

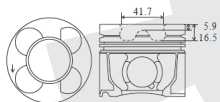



## DIESEL

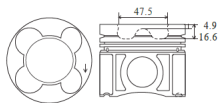

ENGINE TYPE Motortyp Type de Moteur Tipo de motor Тип двигателя	LINER KIT Liner Kit Kit de Chemise Camisas de los cilindros лайнер комплект	CYL. LINER Zylinderlaufbuchse Chemise Camisas de los cilindros втулка цилиндра	PISTON + RINGS Kolben + Ringe Piston + Segments Pistón Set Поршень и кольца			PISTON SET Kolben Set Set de Piston Pistón Set поршневой	RINGS SET Kolben Set Segments de Piston Anillos Set кольца	PIN Pin Axe Perno Пин
<b>M47/M47N</b> <b>M57N/M57N2</b> 4/6 Cyl 84.0 mm Bore Ø 1,995 cc 2,993 cc		Length: 44.85 Outside Ø: Flange Ø: flange depth	Length: 70.6 Comp: -4.9 Height: 14.6		alfin and with oil gallery skirt MOS2 treated pin bushing inserted	Top: 3.0 double keystone	Ø: 30.0 Length: 68.0	
						2nd: 2.0 3rd: 2.0 1st oil: 2.0 2nd oil:		
		Reference no.:	Reference no.:	Reference no.:	Reference no.:	O-RING		
			<b>N-8711440040</b>			<b>G-0811440040</b>		
NM-Germany Article no. Artikelnummer/ Modelo Número / статья НОМЕР	NM-Germany Article no.	NM-Germany Article no.	NM-Germany Article no.	NM-Germany Article no.	NM-Germany Article no.	NM-Germany Article no.	NM-Germany Article no.	
			<b>KBSBM460108DB</b>	<b>KBBM460108DB</b>	<b>KRBM460108DB</b>			

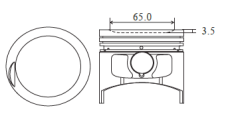

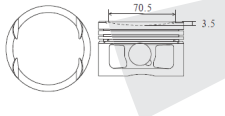

**GASOLINE**

ENGINE TYPE Motortyp Type de Moteur Tipo de motor Тип двигателя	LINER KIT Liner Kit Kit de Chemise Camisas de los cilindros лайнер комплект	CYL. LINER Zylinderlaufbuchse Chemise Camisas de los cilindros втулка цилиндра	PISTON + RINGS Kolben + Ringe Piston + Segments Pistón Set Поршень и кольца			PISTON SET Kolben Set Set de Piston Pistón Set поршневой	RINGS SET Kolben Set Segments de Piston Anillos Set кольца	PIN Pin Axe Perno Пин
<b>M20B27 ME</b> 6 Cyl 84.0 mm Bore Ø 2,693 cc		Length:		Length:	77.7	Top:	1.5	Ø: 22.0 Length: 52.9
		Outside Ø:		Comp:	35.7	2nd:	2.0	
		Flange Ø:		Height:	-3.5	3rd:	4.0	
		flange depth				1st oil:	4.0	
			Reference no.:	Reference no.:	Reference no.:	Reference no.:	O-RING	
				<b>K-90017600</b> <b>M-0823400</b>	<b>11 25 1 287 039</b> <b>11 25 1 287 096</b>	<b>K-800002061000</b> <b>M-08234N0</b>		
NM-Germany Article no. Artikelnummer/ Modelo Número / статья НОМЕР	NM-Germany Article no.	NM-Germany Article no.	NM-Germany Article no.	NM-Germany Article no.	NM-Germany Article no.	NM-Germany Article no.	NM-Germany Article no.	
			<b>KBSBM60109G</b>	<b>KBBM60109G</b>	<b>KRBM60109G</b>			

**GASOLINE**

ENGINE TYPE Motortyp Type de Moteur Tipo de motor Тип двигателя	LINER KIT Liner Kit Kit de Chemise Camisas de los cilindros лайнер комплект	CYL. LINER Zylinderlaufbuchse Chemise Camisas de los cilindros втулка цилиндра	PISTON + RINGS Kolben + Ringe Piston + Segments Pistón Set Поршень и кольца			PISTON SET Kolben Set Set de Piston Pistón Set поршневой	RINGS SET Kolben Set Segments de Piston Anillos Set кольца	PIN Pin Axe Perno Пин
<b>M42B18 M42B18 TU1</b> 4 Cyl 84.0 mm Bore Ø 1,796 cc		Length:		Length:	53.0	Top:	1.5	Ø: 22.0 Length: 54.0
		Outside Ø:		Comp:	31.7	2nd:	1.5	
		Flange Ø:		Height:	-3.5	3rd:	2.0	
		flange depth				1st oil:	2.0	
			Reference no.:	Reference no.:	Reference no.:	Reference no.:	O-RING	
				<b>K-92213600</b> <b>M-0829300</b>	<b>11 25 1 739 451</b>	<b>11 25 1 727 461</b> <b>11 25 1 727 462</b> <b>11 25 1 739 441</b> <b>A-R66500</b> <b>G-0870510000</b> <b>K-800001840000</b> <b>M-08272N0</b>		
NM-Germany Article no. Artikelnummer/ Modelo Número / статья НОМЕР	NM-Germany Article no.	NM-Germany Article no.	NM-Germany Article no.	NM-Germany Article no.	NM-Germany Article no.	NM-Germany Article no.	NM-Germany Article no.	
			<b>KBSBM40110G</b>	<b>KBBM40110G</b>	<b>KRBM40110G</b>			

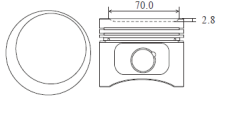
**GASOLINE**

ENGINE TYPE Motortyp Type de Moteur Tipo de motor Тип двигателя	LINER KIT Liner Kit Kit de Chemise Camisas de los cilindros лайнер комплект	CYL. LINER Zylinderlaufbuchse Chemise Camisas de los cilindros втулка цилиндра	PISTON + RINGS Kolben + Ringe Piston + Segments Pistón Set Поршень и кольца			PISTON SET Kolben Set Set de Piston Pistón Set поршневой	RINGS SET Kolben Set Segments de Piston Anillos Set кольца	PIN Pin Axe Perno Пин
<b>M40B16 M40B16 ME M40B16 ME.8</b> 4 Cyl 84.0 mm Bore Ø 1,596 cc		Length:		Length:	67.2	Top:	1.5	Ø: 22.0 Length: 54.0
		Outside Ø:		Comp:	41.2	2nd:	1.75	
		Flange Ø:		Height:	-2.8	3rd:	3.0	
		flange depth				1st oil:	3.0	
			Reference no.:	Reference no.:	Reference no.:	Reference no.:	O-RING	
				<b>K-90429600</b> <b>M-0811700</b> <b>N-8770260000</b>	<b>11 25 1 721 621</b> <b>11 25 1 727 711</b> <b>11 25 1 739 009</b>	<b>11 25 1 713 179</b> <b>11 25 1 713 192</b> <b>11 25 1 713 193</b> <b>G-0870260000</b> <b>K-800001921000</b> <b>M-08121N0</b>		
NM-Germany Article no. Artikelnummer/ Modelo Número / статья НОМЕР	NM-Germany Article no.	NM-Germany Article no.	NM-Germany Article no.	NM-Germany Article no.	NM-Germany Article no.	NM-Germany Article no.	NM-Germany Article no.	
			<b>KBSBM40111G</b>	<b>KBBM40111G</b>	<b>KRBM40111G</b>			

## GASOLINE

ENGINE TYPE Motortyp Type de Moteur Tipo de motor Тип двигателя	LINER KIT Liner Kit Kit de Chemise Camisas de los cilindros лайнер комплект	CYL. LINER Zylinderlaufbuchse Chemise Camisas de los cilindros втулка цилиндра	PISTON + RINGS Kolben + Ringe Piston + Segments Pistón Set Поршень и кольца			PISTON SET Kolben Set Set de Piston Pistón Set поршневой	RINGS SET Kolben Set Segments de Piston Anillos Set кольца	PIN Pin Axe Perno Пин			
<b>M40B18 ME</b> <b>4 Cyl</b> <b>84.0 mm Bore Ø</b> <b>1,766 cc 1,796 cc</b>		Length: Outside Ø: Flange Ø: flange depth	Length: 62.7 Comp: 36.7 Height: -6.1			Top: 1.5 2nd: 1.75 3rd: 1st oil: 3.0 2nd oil:	Ø: 22.0 Length: 52.0				
						Reference no.:		Reference no.:	Reference no.:	Reference no.:	O-RING
								<b>K-90006600</b> <b>M-0812100</b>	<b>11 25 1 709 973</b>	<b>11 25 1 713 179</b> <b>11 25 1 713 192</b> <b>11 25 1 713 193</b> <b>G-0870260000</b> <b>K-800001921000</b> <b>M-08121N0</b>	
NM-Germany Article no. Artikelnummer/ Modelo Número / статья НОМЕР	NM-Germany Article no.	NM-Germany Article no.	NM-Germany Article no.	NM-Germany Article no.	NM-Germany Article no.	NM-Germany Article no.	NM-Germany Article no.				
			KBSBM40112G	KBBM40112G	KRBM40112G						

## GASOLINE

ENGINE TYPE Motortyp Type de Moteur Tipo de motor Тип двигателя	LINER KIT Liner Kit Kit de Chemise Camisas de los cilindros лайнер комплект	CYL. LINER Zylinderlaufbuchse Chemise Camisas de los cilindros втулка цилиндра	PISTON + RINGS Kolben + Ringe Piston + Segments Pistón Set Поршень и кольца			PISTON SET Kolben Set Set de Piston Pistón Set поршневой	RINGS SET Kolben Set Segments de Piston Anillos Set кольца	PIN Pin Axe Perno Пин			
<b>M20B25 ME</b> <b>M20B25 ME.8</b> <b>6 Cyl</b> <b>84.0 mm Bore Ø</b> <b>2,494 cc</b>		Length: Outside Ø: Flange Ø: flange depth	Length: 69.2 Comp: 34.3 Height: 4.0 -5.2			Top: 1.5 2nd: 1.75 3rd: 1st oil: 3.0 2nd oil:	Ø: 22.0 Length: 54.0				
						Reference no.:		Reference no.:	Reference no.:	Reference no.:	O-RING
								<b>K-90102600</b> <b>M-0811600</b>	<b>11 25 1 718 924</b> <b>11 25 1 720 865</b>	<b>11 25 1 713 179</b> <b>11 25 1 713 192</b> <b>11 25 1 713 193</b> <b>G-0870260000</b> <b>K-800001921000</b> <b>M-08121N0</b>	
NM-Germany Article no. Artikelnummer/ Modelo Número / статья НОМЕР	NM-Germany Article no.	NM-Germany Article no.	NM-Germany Article no.	NM-Germany Article no.	NM-Germany Article no.	NM-Germany Article no.	NM-Germany Article no.				
			KBSBM60113G	KBBM60113G	KRBM60113G						

## GASOLINE

ENGINE TYPE Motortyp Type de Moteur Tipo de motor Тип двигателя	LINER KIT Liner Kit Kit de Chemise Camisas de los cilindros лайнер комплект	CYL. LINER Zylinderlaufbuchse Chemise Camisas de los cilindros втулка цилиндра	PISTON + RINGS Kolben + Ringe Piston + Segments Pistón Set Поршень и кольца			PISTON SET Kolben Set Set de Piston Pistón Set поршневой	RINGS SET Kolben Set Segments de Piston Anillos Set кольца	PIN Pin Axe Perno Пин			
<b>M50B25 M1.E</b> <b>M50B25 TU</b> <b>6 Cyl</b> <b>84.0 mm Bore Ø</b> <b>2,494 cc</b>		Length: Outside Ø: Flange Ø: flange depth	Length: 50.1 Comp: 32.6 Height: -1.6 -3.2		top ring land and skirt MOS2 treated	Top: 1.5 2nd: 1.5 3rd: 1st oil: 2.0 2nd oil:	Ø: 22.0 Length: 54.0				
						Reference no.:		Reference no.:	Reference no.:	Reference no.:	O-RING
								<b>K-92186600</b> <b>M-0826800</b> <b>M-0831900</b> <b>N-8770510000</b>	<b>11 25 1 703 456</b> <b>11 25 1 738 717</b> <b>11 25 1 748 460</b>	<b>11 25 1 727 461</b> <b>11 25 1 727 462</b> <b>11 25 1 739 441</b> <b>A-R66500</b> <b>G-0870510000</b> <b>K-800001840000</b> <b>M-08272N0</b>	
NM-Germany Article no. Artikelnummer/ Modelo Número / статья НОМЕР	NM-Germany Article no.	NM-Germany Article no.	NM-Germany Article no.	NM-Germany Article no.	NM-Germany Article no.	NM-Germany Article no.	NM-Germany Article no.				
			KBSBM60114G	KBBM60114G	KRBM60114G						

**GASOLINE**

ENGINE TYPE Motortyp Type de Moteur Tipo de motor Тип двигателя	LINER KIT Liner Kit Kit de Chemise Camisas de los cilindros лайнер комплект	CYL. LINER Zylinderlaufbuchse Chemise Camisas de los cilindros втулка цилиндра	PISTON + RINGS Kolben + Ringe Piston + Segments Pistón Set Поршень и кольца			PISTON SET Kolben Set Set de Piston Pistón Set поршневой	RINGS SET Kolben Set Segments de Piston Anillos Set кольца	PIN Pin Axe Perno Пин				
<b>M40B16</b> 4 Cyl 84.0 mm Bore Ø 1,596 cc		Length: Outside Ø: Flange Ø: flange depth	Length: Comp: Height:	58.1 36.1 -2.7		Top: 1.5 2nd: 1.75 3rd: 3.0 1st oil: 2nd oil:	Ø: 22.0 Length: 54.0					
								Reference no.:	Reference no.:	Reference no.:	Reference no.:	O-RING
									<b>K-90864600</b> <b>M-0810400</b>	<b>11 25 1 739 501</b>	<b>11 25 1 713 179</b> <b>11 25 1 713 192</b> <b>11 25 1 713 193</b> <b>G-0870260000</b> <b>K-800001921000</b> <b>M-08121N0</b>	
NM-Germany Article no. Artikelnummer/ Modelo Número / статья НОМЕР	NM-Germany Article no.	NM-Germany Article no.	NM-Germany Article no.	NM-Germany Article no.	NM-Germany Article no.	NM-Germany Article no.	NM-Germany Article no.					
			<b>KBSBM40115G</b>	<b>KBBM40115G</b>	<b>KRBM40115G</b>							

**GASOLINE**

ENGINE TYPE Motortyp Type de Moteur Tipo de motor Тип двигателя	LINER KIT Liner Kit Kit de Chemise Camisas de los cilindros лайнер комплект	CYL. LINER Zylinderlaufbuchse Chemise Camisas de los cilindros втулка цилиндра	PISTON + RINGS Kolben + Ringe Piston + Segments Pistón Set Поршень и кольца			PISTON SET Kolben Set Set de Piston Pistón Set поршневой	RINGS SET Kolben Set Segments de Piston Anillos Set кольца	PIN Pin Axe Perno Пин				
<b>M40B18 E</b> <b>M40B18 ME</b> 4 Cyl 84.0 mm Bore Ø 1,796 cc		Length: Outside Ø: Flange Ø: flange depth	Length: Comp: Height:	58.0 31.6 -5.2		Top: 1.5 2nd: 1.5 3rd: 2.0 1st oil: 2nd oil:	Ø: 22.0 Length: 52.0					
								Reference no.:	Reference no.:	Reference no.:	Reference no.:	O-RING
									<b>K-90920600</b> <b>M-0827200</b>	<b>11 25 1 727 701</b> <b>11 25 1 739 301</b>	<b>11 25 1 727 461</b> <b>11 25 1 727 462</b> <b>11 25 1 739 441</b> <b>A-R66500</b> <b>G-0870510000</b> <b>K-800001840000</b> <b>M-08272N0</b>	
NM-Germany Article no. Artikelnummer/ Modelo Número / статья НОМЕР	NM-Germany Article no.	NM-Germany Article no.	NM-Germany Article no.	NM-Germany Article no.	NM-Germany Article no.	NM-Germany Article no.	NM-Germany Article no.					
			<b>KBSBM40116G</b>	<b>KBBM40116G</b>	<b>KRBM40116G</b>							

**GASOLINE**

ENGINE TYPE Motortyp Type de Moteur Tipo de motor Тип двигателя	LINER KIT Liner Kit Kit de Chemise Camisas de los cilindros лайнер комплект	CYL. LINER Zylinderlaufbuchse Chemise Camisas de los cilindros втулка цилиндра	PISTON + RINGS Kolben + Ringe Piston + Segments Pistón Set Поршень и кольца			PISTON SET Kolben Set Set de Piston Pistón Set поршневой	RINGS SET Kolben Set Segments de Piston Anillos Set кольца	PIN Pin Axe Perno Пин				
<b>M20B25 M1.Z7</b> 6 Cyl 84.0 mm Bore Ø 2,494 cc		Length: Outside Ø: Flange Ø: flange depth	Length: Comp: Height:	69.3 34.3 4.1 -6.3		Top: 1.5 2nd: 1.75 3rd: 3.0 1st oil: 2nd oil:	Ø: 22.0 Length: 54.0					
								Reference no.:	Reference no.:	Reference no.:	Reference no.:	O-RING
									<b>K-93127600</b> <b>M-0811500</b>	<b>11 25 1 714 807</b> <b>11 25 1 726 417</b> <b>11 25 1 735 755</b>	<b>11 25 1 713 179</b> <b>11 25 1 713 192</b> <b>11 25 1 713 193</b> <b>G-0870260000</b> <b>K-800001921000</b> <b>M-08121N0</b>	
NM-Germany Article no. Artikelnummer/ Modelo Número / статья НОМЕР	NM-Germany Article no.	NM-Germany Article no.	NM-Germany Article no.	NM-Germany Article no.	NM-Germany Article no.	NM-Germany Article no.	NM-Germany Article no.					
			<b>KBSBM60117G</b>	<b>KBBM60117G</b>	<b>KRBM60117G</b>							

**GASOLINE**

ENGINE TYPE Motortyp Type de Moteur Tipo de motor Тип двигателя	LINER KIT Liner Kit Kit de Chemise Camisas de los cilindros лайнер комплект	CYL. LINER Zylinderlaufbuchse Chemise Camisas de los cilindros втулка цилиндра	PISTON + RINGS Kolben + Ringe Piston + Segments Pistón Set Поршень и кольца			PISTON SET Kolben Set Set de Piston Pistón Set поршневой	RINGS SET Kolben Set Segments de Piston Anillos Set кольца	PIN Pin Axe Perno Пин					
<b>M50B25M</b> 6 Cyl 84.0 mm Bore Ø 2,494 cc		Length: Outside Ø: Flange Ø: flange depth	Length: Comp: Height:	63.2 38.2 -4.1		Top: 2nd: 3rd: 1st oil: 2nd oil:	1.5 1.75 3.0	Ø: 22.0 Length: 54.0					
									Reference no.:	Reference no.:	Reference no.:	Reference no.:	O-RING
										<b>K-90565600</b> <b>M-0827100</b>	<b>11 25 1 722 492</b> <b>11 25 1 722 497</b>	<b>11 25 1 713 179</b> <b>11 25 1 713 192</b> <b>11 25 1 713 193</b> <b>G-0870260000</b> <b>K-800001921000</b> <b>M-08121N0</b>	
NM-Germany Article no. Artikelnummer/ Modelo Número / статья НОМЕР	NM-Germany Article no.	NM-Germany Article no.	NM-Germany Article no.	NM-Germany Article no.	NM-Germany Article no.	NM-Germany Article no.	NM-Germany Article no.						
			<b>KBSBM60118G</b>	<b>KBBM60118G</b>	<b>KRBM60118G</b>								

**GASOLINE**

ENGINE TYPE Motortyp Type de Moteur Tipo de motor Тип двигателя	LINER KIT Liner Kit Kit de Chemise Camisas de los cilindros лайнер комплект	CYL. LINER Zylinderlaufbuchse Chemise Camisas de los cilindros втулка цилиндра	PISTON + RINGS Kolben + Ringe Piston + Segments Pistón Set Поршень и кольца			PISTON SET Kolben Set Set de Piston Pistón Set поршневой	RINGS SET Kolben Set Segments de Piston Anillos Set кольца	PIN Pin Axe Perno Пин					
<b>M52B25</b> 6 Cyl 84.0 mm Bore Ø 2,494 cc		Length: Outside Ø: Flange Ø: flange depth	Length: Comp: Height:	52.6 32.7 -2.95 -3.15		Top: 2nd: 3rd: 1st oil: 2nd oil:	1.5 1.5 2.0	Ø: 22.0 Length: 56.0					
									Reference no.:	Reference no.:	Reference no.:	Reference no.:	O-RING
										<b>K-40303600</b> <b>M-0830900</b>	<b>11 25 1 437 046</b>	<b>11 25 1 727 461</b> <b>11 25 1 727 462</b> <b>11 25 1 739 441</b> <b>A-R66500</b> <b>G-0870510000</b> <b>K-800001840000</b> <b>M-08272N0</b>	
NM-Germany Article no. Artikelnummer/ Modelo Número / статья НОМЕР	NM-Germany Article no.	NM-Germany Article no.	NM-Germany Article no.	NM-Germany Article no.	NM-Germany Article no.	NM-Germany Article no.	NM-Germany Article no.						
			<b>KBSBM60119G</b>	<b>KBBM60119G</b>	<b>KRBM60119G</b>								

**GASOLINE**

ENGINE TYPE Motortyp Type de Moteur Tipo de motor Тип двигателя	LINER KIT Liner Kit Kit de Chemise Camisas de los cilindros лайнер комплект	CYL. LINER Zylinderlaufbuchse Chemise Camisas de los cilindros втулка цилиндра	PISTON + RINGS Kolben + Ringe Piston + Segments Pistón Set Поршень и кольца			PISTON SET Kolben Set Set de Piston Pistón Set поршневой	RINGS SET Kolben Set Segments de Piston Anillos Set кольца	PIN Pin Axe Perno Пин					
<b>M52B28</b> 6 Cyl 84.0 mm Bore Ø 2,792 cc		Length: Outside Ø: Flange Ø: flange depth	Length: Comp: Height:	51.82 31.82 -0.6 -2.4	skirt MOS2 treated	Top: 2nd: 3rd: 1st oil: 2nd oil:	1.5 1.5 2.0	Ø: 22.0 Length: 56.0					
									Reference no.:	Reference no.:	Reference no.:	Reference no.:	O-RING
										<b>M-0831600</b>	<b>11 25 1 432 806</b> <b>11 25 1 432 807</b>	<b>M-08316N0</b>	
NM-Germany Article no. Artikelnummer/ Modelo Número / статья НОМЕР	NM-Germany Article no.	NM-Germany Article no.	NM-Germany Article no.	NM-Germany Article no.	NM-Germany Article no.	NM-Germany Article no.	NM-Germany Article no.						
			<b>KBSBM60120G</b>	<b>KBBM60120G</b>	<b>KRBM60120G</b>								



**DIESEL**

ENGINE TYPE Motortyp Type de Moteur Tipo de motor Тип двигателя	LINER KIT Liner Kit Kit de Chemise Camisas de los cilindros лайнер комплект	CYL. LINER Zylinderlaufbuchse Chemise Camisas de los cilindros втулка цилиндра	PISTON + RINGS Kolben + Ringe Piston + Segments Pistón Set Поршень и кольца			PISTON SET Kolben Set Set de Piston Pistón Set поршневой	RINGS SET Kolben Set Segments de Piston Anillos Set кольца	PIN Pin Axe Perno Пин					
<b>N55B30 A</b> 6 Cyl 84.0 mm Bore Ø 2,979 cc		Length: Outside Ø: Flange Ø: flange depth	Length: Comp: Height:	52.15 33.15 0.75	head anodized fits tapered con. rod	Top: 2nd: 3rd: 1st oil: 2nd oil:	1.2 1.5 2.0	Ø: 22.0 Length: 54.0					
									Reference no.:	Reference no.:	Reference no.:	Reference no.:	O-RING
										<b>K-40653600</b>			
NM-Germany Article no. Artikelnummer/ Modelo Número / статья НОМЕР	NM-Germany Article no.	NM-Germany Article no.	NM-Germany Article no.	NM-Germany Article no.	NM-Germany Article no.	NM-Germany Article no.	NM-Germany Article no.	NM-Germany Article no.					
			<b>KBSBM60121D</b>	<b>KBBM60121D</b>	<b>KRBM60121D</b>								



**GASOLINE**

ENGINE TYPE Motortyp Type de Moteur Tipo de motor Тип двигателя	LINER KIT Liner Kit Kit de Chemise Camisas de los cilindros лайнер комплект	CYL. LINER Zylinderlaufbuchse Chemise Camisas de los cilindros втулка цилиндра	PISTON + RINGS Kolben + Ringe Piston + Segments Pistón Set Поршень и кольца			PISTON SET Kolben Set Set de Piston Pistón Set поршневой	RINGS SET Kolben Set Segments de Piston Anillos Set кольца	PIN Pin Axe Perno Пин					
<b>N43B20 OL</b> <b>N43B20 UL</b> 4 Cyl 84.0 mm Bore Ø 1,995 cc		Length: Outside Ø: Flange Ø: flange depth	Length: Comp: Height:	49.6 29.35 1.3	head anodized fits tapered con. rod	Top: 2nd: 3rd: 1st oil: 2nd oil:	1.2 1.5 2.0	Ø: 20.0 Length: 48.0					
									Reference no.:	Reference no.:	Reference no.:	Reference no.:	O-RING
										<b>K-40420600</b>			
NM-Germany Article no. Artikelnummer/ Modelo Número / статья НОМЕР	NM-Germany Article no.	NM-Germany Article no.	NM-Germany Article no.	NM-Germany Article no.	NM-Germany Article no.	NM-Germany Article no.	NM-Germany Article no.	NM-Germany Article no.					
			<b>KBSBM40122G</b>	<b>KBBM40122G</b>	<b>KRBM40122G</b>								



**GASOLINE**

ENGINE TYPE Motortyp Type de Moteur Tipo de motor Тип двигателя	LINER KIT Liner Kit Kit de Chemise Camisas de los cilindros лайнер комплект	CYL. LINER Zylinderlaufbuchse Chemise Camisas de los cilindros втулка цилиндра	PISTON + RINGS Kolben + Ringe Piston + Segments Pistón Set Поршень и кольца			PISTON SET Kolben Set Set de Piston Pistón Set поршневой	RINGS SET Kolben Set Segments de Piston Anillos Set кольца	PIN Pin Axe Perno Пин					
<b>M43TU B19</b> 4 Cyl 85.0 mm Bore Ø 1,895 cc		Length: Outside Ø: Flange Ø: flange depth	Length: Comp: Height:	53.9 30.4 -4.0		Top: 2nd: 3rd: 1st oil: 2nd oil:	1.2 1.5 2.0	Ø: 22.0 Length: 54.0					
									Reference no.:	Reference no.:	Reference no.:	Reference no.:	O-RING
										<b>K-94895600</b> <b>M-0831000</b>		<b>K-800039040000</b> <b>M-08310N0</b>	
NM-Germany Article no. Artikelnummer/ Modelo Número / статья НОМЕР	NM-Germany Article no.	NM-Germany Article no.	NM-Germany Article no.	NM-Germany Article no.	NM-Germany Article no.	NM-Germany Article no.	NM-Germany Article no.	NM-Germany Article no.					
			<b>KBSBM40123G</b>	<b>KBBM40123G</b>	<b>KRBM40123G</b>								



## GASOLINE

ENGINE TYPE Motortyp Type de Moteur Tipo de motor Тип двигателя	LINER KIT Liner Kit Kit de Chemise Camisas de los cilindros лайнер комплект	CYL. LINER Zylinderlaufbuchse Chemise Camisas de los cilindros втулка цилиндра	PISTON + RINGS Kolben + Ringe Piston + Segments Pistón Set Поршень и кольца	PISTON SET Kolben Set Set de Piston Pistón Set поршневой	RINGS SET Kolben Set Segments de Piston Anillos Set кольца	PIN Pin Axe Perno Пин
<b>M30B28 L</b> <b>M30B28 V</b> 6 Cyl 86.0 mm Bore Ø 2,788 cc	 	Length: Outside Ø: Flange Ø: flange depth	Length: 84.6 Comp: 42.8 Height: 5.8		Top: 1.75 2nd: 2.0 3rd: 1st oil: 4.0 2nd oil:	Ø: 22.0 Length: 71.0
		Reference no.:	Reference no.:	Reference no.:	Reference no.:	O-RING
			<b>K-93456600</b> <b>M-0819100</b> <b>M-0824200</b>	11 25 1 251 807 11 25 1 251 995 11 25 1 262 001 11 25 1 262 002 11 25 1 262 007 11 25 1 267 265 11 26 1 267 295	<b>11 25 1 256 462</b> <b>K-80002261000</b> <b>M-08240N0</b>	
NM-Germany Article no. Artikelnummer/ Modelo Número / статья НОМЕР	NM-Germany Article no.	NM-Germany Article no.	NM-Germany Article no.	NM-Germany Article no.	NM-Germany Article no.	NM-Germany Article no.
			<b>KBSBM60124G</b>	<b>KBBM60124G</b>	<b>KRBM60124G</b>	



## GASOLINE

ENGINE TYPE Motortyp Type de Moteur Tipo de motor Тип двигателя	LINER KIT Liner Kit Kit de Chemise Camisas de los cilindros лайнер комплект	CYL. LINER Zylinderlaufbuchse Chemise Camisas de los cilindros втулка цилиндра	PISTON + RINGS Kolben + Ringe Piston + Segments Pistón Set Поршень и кольца	PISTON SET Kolben Set Set de Piston Pistón Set поршневой	RINGS SET Kolben Set Segments de Piston Anillos Set кольца	PIN Pin Axe Perno Пин
<b>M15E12</b> 4 Cyl 89.0 mm Bore Ø 1,990 cc	 	Length: Outside Ø: Flange Ø: flange depth	Length: 86.9 Comp: 42.1 Height: 6.8		Top: 1.75 2nd: 2.0 3rd: 1st oil: 4.0 2nd oil:	Ø: 22.0 Length: 70.9
		Reference no.:	Reference no.:	Reference no.:	Reference no.:	O-RING
			<b>K-92169600</b> <b>M-0820200</b>	11 25 1 256 744 11 25 1 256 750 11 25 1 256 892 11 25 1 261 877 11 25 1 261 878 11 25 1 261 883	<b>M-08193N0</b>	
NM-Germany Article no. Artikelnummer/ Modelo Número / статья НОМЕР	NM-Germany Article no.	NM-Germany Article no.	NM-Germany Article no.	NM-Germany Article no.	NM-Germany Article no.	NM-Germany Article no.
			<b>KBSBM40125G</b>	<b>KBBM40125G</b>	<b>KRBM40125G</b>	

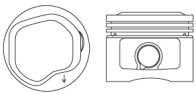

## GASOLINE

ENGINE TYPE Motortyp Type de Moteur Tipo de motor Тип двигателя	LINER KIT Liner Kit Kit de Chemise Camisas de los cilindros лайнер комплект	CYL. LINER Zylinderlaufbuchse Chemise Camisas de los cilindros втулка цилиндра	PISTON + RINGS Kolben + Ringe Piston + Segments Pistón Set Поршень и кольца	PISTON SET Kolben Set Set de Piston Pistón Set поршневой	RINGS SET Kolben Set Segments de Piston Anillos Set кольца	PIN Pin Axe Perno Пин
<b>M10B18 K/S/V</b> <b>M10B18 LE</b> <b>M10B18 LU</b> 4 Cyl 89.0 mm Bore Ø 1,767 cc	 	Length: Outside Ø: Flange Ø: flange depth	Length: 83.6 Comp: 47.1 Height: 4.5		Top: 1.75 2nd: 2.0 3rd: 1st oil: 4.0 2nd oil:	Ø: 22.0 Length: 58.0
		Reference no.:	Reference no.:	Reference no.:	Reference no.:	O-RING
			<b>K-93700600</b> <b>M-0823200</b> <b>N-8713290000</b>	11 25 1 274 759 11 25 1 274 965 11 25 1 274 970 11 25 1 277 282 11 25 1 286 351 11 25 1 705 232 11 25 1 705 244	<b>11 25 1 261 130</b> <b>A-R45900</b> <b>G-0813290000</b> <b>K-80002421000</b> <b>M-08232N0</b>	
NM-Germany Article no. Artikelnummer/ Modelo Número / статья НОМЕР	NM-Germany Article no.	NM-Germany Article no.	NM-Germany Article no.	NM-Germany Article no.	NM-Germany Article no.	NM-Germany Article no.
			<b>KBSBM40126G</b>	<b>KBBM40126G</b>	<b>KRBM40126G</b>	



**GASOLINE**

ENGINE TYPE	LINER KIT	CYL. LINER	PISTON + RINGS			PISTON SET	RINGS SET	PIN
Motorotyp Type de Moteur Tipo de motor Тип двигателя	Liner Kit Kit de Chemise Camisas de los cilindros лайнер комплект	Zylinderlaufbuchse Chemise Camisas de los cilindros втулка цилиндра	Kolben + Ringe Piston + Segments Pistón Set Поршень и кольца			Kolben Set Set de Piston Pistón Set поршневой	Kolben Set Segments de Piston Anillos Set кольца	Pin Axe Perno Пин
<b>M30B30 M.E7</b> 6 Cyl 89.0 mm Bore Ø 2,986 cc		Length: Outside Ø: Flange Ø: flange depth	Length: 71.71 Comp: 42.8 Height: 2.91			Top: 1.5 2nd: 2.0 3rd: 1st oil: 3.5 2nd oil:	Ø: 22.0 Length: 62.0	
		Reference no.:	Reference no.:	Reference no.:	Reference no.:	O-RING		
			<b>K-90053600</b> <b>M-0827500</b> <b>M-0827600</b>	<b>11 25 1 714 958 E</b> <b>11 25 1 714 964 E</b> <b>11 25 1 717 104 AE</b> <b>11 25 1 717 109 A</b> <b>11 25 1 722 702</b> <b>11 25 1 722 707</b> <b>11 25 1 726 885</b> <b>11 25 1 726 893</b>	<b>K-800002360000</b>			
NM-Germany Article no. Artikelnummer/ Modelo Número / статья НОМЕР	NM-Germany Article no.	NM-Germany Article no.	NM-Germany Article no.	NM-Germany Article no.	NM-Germany Article no.	NM-Germany Article no.	NM-Germany Article no.	
			<b>KBSBM60127G</b>	<b>KBBM60127G</b>	<b>KRBM60127G</b>			

**GASOLINE**

ENGINE TYPE	LINER KIT	CYL. LINER	PISTON + RINGS			PISTON SET	RINGS SET	PIN
Motorotyp Type de Moteur Tipo de motor Тип двигателя	Liner Kit Kit de Chemise Camisas de los cilindros лайнер комплект	Zylinderlaufbuchse Chemise Camisas de los cilindros втулка цилиндра	Kolben + Ringe Piston + Segments Pistón Set Поршень и кольца			Kolben Set Set de Piston Pistón Set поршневой	Kolben Set Segments de Piston Anillos Set кольца	Pin Axe Perno Пин
<b>M10B18 LU</b> 4 Cyl 89.0 mm Bore Ø 1,767 cc		Length: Outside Ø: Flange Ø: flange depth	Length: 82.7 Comp: 47.1 Height: 3.6			Top: 1.75 2nd: 2.0 3rd: 1st oil: 4.0 2nd oil:	Ø: 22.0 Length: 58.0	
		Reference no.:	Reference no.:	Reference no.:	Reference no.:	O-RING		
			<b>K-93691600</b> <b>M-0824500</b>	<b>11 25 1 705 364</b> <b>11 25 1 705 545</b>	<b>11 25 1 261 130</b> <b>A-R45900</b> <b>G-0813290000</b> <b>K-800002421000</b> <b>M-08232N0</b>			
NM-Germany Article no. Artikelnummer/ Modelo Número / статья НОМЕР	NM-Germany Article no.	NM-Germany Article no.	NM-Germany Article no.	NM-Germany Article no.	NM-Germany Article no.	NM-Germany Article no.	NM-Germany Article no.	
			<b>KBSBM40128G</b>	<b>KBBM40128G</b>	<b>KRBM40128G</b>			

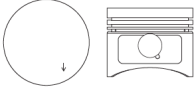
**GASOLINE**

ENGINE TYPE	LINER KIT	CYL. LINER	PISTON + RINGS			PISTON SET	RINGS SET	PIN
Motorotyp Type de Moteur Tipo de motor Тип двигателя	Liner Kit Kit de Chemise Camisas de los cilindros лайнер комплект	Zylinderlaufbuchse Chemise Camisas de los cilindros втулка цилиндра	Kolben + Ringe Piston + Segments Pistón Set Поршень и кольца			Kolben Set Set de Piston Pistón Set поршневой	Kolben Set Segments de Piston Anillos Set кольца	Pin Axe Perno Пин
<b>M60B40</b> 8 Cyl 89.0 mm Bore Ø 3,982 cc		Length: Outside Ø: Flange Ø: flange depth	Length: 58.95 Comp: 32.95 Height: 0			Top: 1.5 2nd: 1.5 3rd: 1st oil: 2.0 2nd oil:	Ø: 22.0 Length: 58.0	
		Reference no.:	Reference no.:	Reference no.:	Reference no.:	O-RING		
			<b>M-0827800</b>	<b>11 25 1 702 040</b> <b>11 25 1 704 842</b> <b>11 25 1 742 541</b> <b>11 25 1 745 911</b> <b>11 25 1 747 193</b>	<b>11 25 9 064 584</b> <b>M-08278N0</b>			
NM-Germany Article no. Artikelnummer/ Modelo Número / статья НОМЕР	NM-Germany Article no.	NM-Germany Article no.	NM-Germany Article no.	NM-Germany Article no.	NM-Germany Article no.	NM-Germany Article no.	NM-Germany Article no.	
			<b>KBSBM80129G</b>	<b>KBBM80129G</b>	<b>KRBM80129G</b>			

**GASOLINE**

ENGINE TYPE Motortyp Type de Moteur Tipo de motor Тип двигателя	LINER KIT Liner Kit Kit de Chemise Camisas de los cilindros лайнер комплект	CYL. LINER Zylinderlaufbuchse Chemise Camisas de los cilindros втулка цилиндра	PISTON + RINGS Kolben + Ringe Piston + Segments Pistón Set Поршень и кольца			PISTON SET Kolben Set Set de Piston Pistón Set поршневой	RINGS SET Kolben Set Segments de Piston Anillos Set кольца	PIN Pin Axe Perno Пин				
<b>M30B35 ME</b> <b>M30B35 M.E7</b> 6 Cyl 92.0 mm Bore Ø 3,453 cc		Length: Outside Ø: Flange Ø: flange depth	Length: 72.8 Comp: 39.8 Height: 2.1			Top: 1.5 2nd: 2.0 3rd: 1st oil: 3.5 2nd oil:	Ø: 22.0 Length: 60.0					
								Reference no.:	Reference no.:	Reference no.:	Reference no.:	O-RING
									<b>K-93972600</b> <b>M-0825800</b> <b>N-8713390010</b>	<b>11 25 1 717 137</b>	<b>11 25 1 284 882</b> <b>11 25 1 288 031</b> <b>11 25 1 714 383</b> <b>G-0813390000</b> <b>K-800002561000</b> <b>M-08257N0</b>	
NM-Germany Article no. Artikelnummer/ Modelo Número / статья НОМЕР	NM-Germany Article no.	NM-Germany Article no.	NM-Germany Article no.	NM-Germany Article no.	NM-Germany Article no.	NM-Germany Article no.	NM-Germany Article no.					
			<b>KBSBM60130G</b>	<b>KBBM60130G</b>	<b>KRBM60130G</b>							

**GASOLINE**

ENGINE TYPE Motortyp Type de Moteur Tipo de motor Тип двигателя	LINER KIT Liner Kit Kit de Chemise Camisas de los cilindros лайнер комплект	CYL. LINER Zylinderlaufbuchse Chemise Camisas de los cilindros втулка цилиндра	PISTON + RINGS Kolben + Ringe Piston + Segments Pistón Set Поршень и кольца			PISTON SET Kolben Set Set de Piston Pistón Set поршневой	RINGS SET Kolben Set Segments de Piston Anillos Set кольца	PIN Pin Axe Perno Пин				
<b>M62B44 LEV</b> 8 Cyl 92.0 mm Bore Ø 4,395 cc		Length: Outside Ø: Flange Ø: flange depth	Length: 53.3 Comp: 31.3 Height: -1.5		top and 2nd ring lands anodized	Top: 1.5 2nd: 1.5 3rd: 1st oil: 2.0 2nd oil:	Ø: 22.0 Length: 60.8					
								Reference no.:	Reference no.:	Reference no.:	Reference no.:	O-RING
									<b>M-0831200</b>	<b>11 25 1 704 500</b> <b>11 25 1 708 901</b>	<b>M-08312N0</b>	
NM-Germany Article no. Artikelnummer/ Modelo Número / статья НОМЕР	NM-Germany Article no.	NM-Germany Article no.	NM-Germany Article no.	NM-Germany Article no.	NM-Germany Article no.	NM-Germany Article no.	NM-Germany Article no.					
			<b>KBSBM80131G</b>	<b>KBBM80131G</b>	<b>KRBM80131G</b>							



**DIESEL**

ENGINE TYPE Motortyp Type de Moteur Tipo de motor Тип двигателя	LINER KIT Liner Kit Kit de Chemise Camisas de los cilindros лайнер комплект	CYL. LINER Zylinderlaufbuchse Chemise Camisas de los cilindros штулка цилиндра	PISTON + RINGS Kolben + Ringe Piston + Segments Pistón Set Поршень и кольца	PISTON SET Kolben Set Set de Piston Pistón Set поршень	RINGS SET Kolben Set Segments de Piston Anillos Set кольца	PIN Pin Axe Perno Пин					
<b>ONE 1.4D 55KW</b>		Length: Outside Ø: Flange Ø: flange depth	Length: 64.1 Comp: 41.7 Height: -7.2 -14.5	alfin and with oil gallery skirt MOS2 treated	Top: 1.5 2nd: 1.5 3rd: 3.0 1st oil: 2nd oil:	Ø: 27.0 Length: 59.0					
							Reference no.:	Reference no.:	Reference no.:	Reference no.:	O-RING
								<b>K-40293600</b>		<b>K-800058010000</b>	
4 Cyl 73.0 mm Bore Ø 1,364 cc											
NM-Germany Article no. Artikelnummer/ Modelo Número / статья НОМЕР	NM-Germany Article no.	NM-Germany Article no.	NM-Germany Article no.	NM-Germany Article no.	NM-Germany Article no.	NM-Germany Article no.					
			<b>KBSBM40092DB</b>	<b>KBBM40092DB</b>	<b>KRBM40092DB</b>						

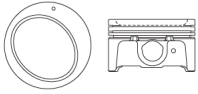

**DIESEL**

ENGINE TYPE Motortyp Type de Moteur Tipo de motor Тип двигателя	LINER KIT Liner Kit Kit de Chemise Camisas de los cilindros лайнер комплект	CYL. LINER Zylinderlaufbuchse Chemise Camisas de los cilindros штулка цилиндра	PISTON + RINGS Kolben + Ringe Piston + Segments Pistón Set Поршень и кольца	PISTON SET Kolben Set Set de Piston Pistón Set поршень	RINGS SET Kolben Set Segments de Piston Anillos Set кольца	PIN Pin Axe Perno Пин					
<b>ONE 1.4D 65KW</b>		Length: Outside Ø: Flange Ø: flange depth	Length: 64.3 Comp: 41.9 Height: -7.3 -14.5	alfin and with oil gallery 2nd ring land anodized skirt MOS2 treated	Top: 1.5 2nd: 1.5 3rd: 3.0 1st oil: 2nd oil:	Ø: 27.0 Length: 59.0					
							Reference no.:	Reference no.:	Reference no.:	Reference no.:	O-RING
								<b>K-40294600</b>		<b>K-800058010000</b>	
4 Cyl 73.0 mm Bore Ø 1,364 cc											
NM-Germany Article no. Artikelnummer/ Modelo Número / статья НОМЕР	NM-Germany Article no.	NM-Germany Article no.	NM-Germany Article no.	NM-Germany Article no.	NM-Germany Article no.	NM-Germany Article no.					
			<b>KBSBM40093DB</b>	<b>KBBM40093DB</b>	<b>KRBM40093DB</b>						



**GASOLINE**

ENGINE TYPE Motortyp Type de Moteur Tipo de motor Тип двигателя	LINER KIT Liner Kit Kit de Chemise Camisas de los cilindros лайнер комплект	CYL. LINER Zylinderlaufbuchse Chemise Camisas de los cilindros втулка цилиндра	PISTON + RINGS Kolben + Ringe Piston + Segments Pistón Set Поршень и кольца			PISTON SET Kolben Set Set de Piston Pistón Set поршневой	RINGS SET Kolben Set Segments de Piston Anillos Set кольца	PIN Pin Axe Perno Пин		
<b>AVEO</b> 4 Cyl 76.5 mm Bore Ø 1,498 cc 		Length: Outside Ø: Flange Ø: flange depth	Length: 46.0 Comp: 28.0 Height: -5.2			Top: 1.65 2nd: 1.5 3rd: 1st oil: 2.0 2nd oil:	Ø: 18.0 Length: 50.0			
						Reference no.:	Reference no.:	Reference no.:	Reference no.:	O-RING
NM-Germany Article no. Artikelnummer/ Modelo Número / статья НОМЕР	NM-Germany Article no.	NM-Germany Article no.	NM-Germany Article no.	NM-Germany Article no.	NM-Germany Article no.	NM-Germany Article no.	NM-Germany Article no.			
			KBSCH40132G	KBCH40132G	KRCH40132G					

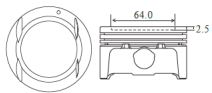

**GASOLINE**

ENGINE TYPE Motortyp Type de Moteur Tipo de motor Тип двигателя	LINER KIT Liner Kit Kit de Chemise Camisas de los cilindros лайнер комплект	CYL. LINER Zylinderlaufbuchse Chemise Camisas de los cilindros втулка цилиндра	PISTON + RINGS Kolben + Ringe Piston + Segments Pistón Set Поршень и кольца			PISTON SET Kolben Set Set de Piston Pistón Set поршневой	RINGS SET Kolben Set Segments de Piston Anillos Set кольца	PIN Pin Axe Perno Пин		
<b>AVEO</b> 4 Cyl 76.5 mm Bore Ø 1,498 cc 		Length: Outside Ø: Flange Ø: flange depth	Length: 51.0 Comp: 28.0 Height: -5.3			Top: 1.5 2nd: 1.5 3rd: 1st oil: 3.0 2nd oil:	Ø: 18.0 Length: 56.0			
						Reference no.:	Reference no.:	Reference no.:	Reference no.:	O-RING
										NP960
NM-Germany Article no. Artikelnummer/ Modelo Número / статья НОМЕР	NM-Germany Article no.	NM-Germany Article no.	NM-Germany Article no.	NM-Germany Article no.	NM-Germany Article no.	NM-Germany Article no.	NM-Germany Article no.			
			KBSCH40133G	KBCH40133G	KRCH40133G					

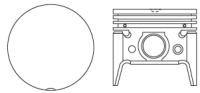

**GASOLINE**

ENGINE TYPE Motortyp Type de Moteur Tipo de motor Тип двигателя	LINER KIT Liner Kit Kit de Chemise Camisas de los cilindros лайнер комплект	CYL. LINER Zylinderlaufbuchse Chemise Camisas de los cilindros втулка цилиндра	PISTON + RINGS Kolben + Ringe Piston + Segments Pistón Set Поршень и кольца			PISTON SET Kolben Set Set de Piston Pistón Set поршневой	RINGS SET Kolben Set Segments de Piston Anillos Set кольца	PIN Pin Axe Perno Пин		
<b>AVEO</b> 4 Cyl 79.0 mm Bore Ø 1,598 cc 		Length: Outside Ø: Flange Ø: flange depth	Length: 49.8 Comp: 27.8 Height: -2.5			Top: 1.2 2nd: 1.5 3rd: 1st oil: 3.0 2nd oil:	Ø: 18.0 Length: 55.0			
						Reference no.:	Reference no.:	Reference no.:	Reference no.:	O-RING
										96389106
NM-Germany Article no. Artikelnummer/ Modelo Número / статья НОМЕР	NM-Germany Article no.	NM-Germany Article no.	NM-Germany Article no.	NM-Germany Article no.	NM-Germany Article no.	NM-Germany Article no.	NM-Germany Article no.			
			KBSCH40134G	KBCH40134G	KRCH40134G					

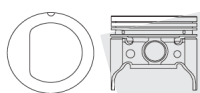

**GASOLINE**

ENGINE TYPE Motortyp Type de Moteur Tipo de motor Тип двигателя	LINER KIT Liner Kit Kit de Chemise Camisas de los cilindros лайнер комплект	CYL. LINER Zylinderlaufbuchse Chemise Camisas de los cilindros втулка цилиндра	PISTON + RINGS Kolben + Ringe Piston + Segments Pistón Set Поршень и кольца			PISTON SET Kolben Set Set de Piston Pistón Set поршневой	RINGS SET Kolben Set Segments de Piston Anillos Set кольца	PIN Pin Axe Perno Пин
<b>141</b> 4 Cyl 98.4 mm Bore Ø 2,507 cc		Length: Outside Ø: Flange Ø: flange depth	Length: 89.2 Comp: 41.77 Height: 0			Top: 2.0 2nd: 2.0 3rd: 1st oil: 4.75 2nd oil:	Ø: 23.6 Length: 76.2	
			Reference no.:	Reference no.:	Reference no.:	Reference no.:	O-RING	
					<b>RP45069</b>			
NM-Germany Article no. Artikelnummer/ Modelo Número / статья НОМЕР	NM-Germany Article no.	NM-Germany Article no.	NM-Germany Article no.	NM-Germany Article no.	NM-Germany Article no.	NM-Germany Article no.	NM-Germany Article no.	
			<b>KBSCH40135G</b>	<b>KBCH40135G</b>	<b>KRCH40135G</b>			

**GASOLINE**

ENGINE TYPE Motortyp Type de Moteur Tipo de motor Тип двигателя	LINER KIT Liner Kit Kit de Chemise Camisas de los cilindros лайнер комплект	CYL. LINER Zylinderlaufbuchse Chemise Camisas de los cilindros втулка цилиндра	PISTON + RINGS Kolben + Ringe Piston + Segments Pistón Set Поршень и кольца			PISTON SET Kolben Set Set de Piston Pistón Set поршневой	RINGS SET Kolben Set Segments de Piston Anillos Set кольца	PIN Pin Axe Perno Пин
<b>250</b> 6 Cyl 98.4 mm Bore Ø 4,095 cc		Length: Outside Ø: Flange Ø: flange depth	Length: 89.3 Comp: 42.0 Height: -1.7			Top: 1.6 2nd: 1.6 3rd: 1st oil: 4.75 2nd oil:	Ø: 23.55 Length: 76.0	
			Reference no.:	Reference no.:	Reference no.:	Reference no.:	O-RING	
					<b>3874468</b> <b>RP45018</b>			
NM-Germany Article no. Artikelnummer/ Modelo Número / статья НОМЕР	NM-Germany Article no.	NM-Germany Article no.	NM-Germany Article no.	NM-Germany Article no.	NM-Germany Article no.	NM-Germany Article no.	NM-Germany Article no.	
			<b>KBSCH60136G</b>	<b>KBCH60136G</b>	<b>KRCH60136G</b>			

**GASOLINE**

ENGINE TYPE Motortyp Type de Moteur Tipo de motor Тип двигателя	LINER KIT Liner Kit Kit de Chemise Camisas de los cilindros лайнер комплект	CYL. LINER Zylinderlaufbuchse Chemise Camisas de los cilindros втулка цилиндра	PISTON + RINGS Kolben + Ringe Piston + Segments Pistón Set Поршень и кольца			PISTON SET Kolben Set Set de Piston Pistón Set поршневой	RINGS SET Kolben Set Segments de Piston Anillos Set кольца	PIN Pin Axe Perno Пин
<b>230</b> 4/6 Cyl 98.4 mm Bore Ø 2,507 cc 3,769 cc	<b>3791692</b> <b>RP45002</b> <b>M-PS3329</b> <b>M-PS3226</b>	Length: Outside Ø: Flange Ø: flange depth	Length: 96.5 Comp: 45.77 Height: -3.8			Top: 2.0 2nd: 2.0 3rd: 1st oil: 4.75 2nd oil:	Ø: 23.6 Length: 76.3	
			Reference no.:	Reference no.:	Reference no.:	Reference no.:	O-RING	
NM-Germany Article no. Artikelnummer/ Modelo Número / статья НОМЕР	NM-Germany Article no.	NM-Germany Article no.	NM-Germany Article no.	NM-Germany Article no.	NM-Germany Article no.	NM-Germany Article no.	NM-Germany Article no.	
			<b>KBSCH460137G</b> <b>KBCH460137G</b> <b>KBSCH460137G</b>	<b>KBCH460137G</b> <b>KBCH460137G</b> <b>KBCH460137G</b>	<b>KRCH460137G</b> <b>KRCH460137G</b> <b>KRCH460137G</b>			

## GASOLINE

ENGINE TYPE Motortyp Type de Moteur Tipo de motor Тип двигателя	LINER KIT Liner Kit Kit de Chemise Camisas de los cilindros лайнер комплект	CYL. LINER Zylinderlaufbuchse Chemise Camisas de los cilindros втулка цилиндра	PISTON + RINGS Kolben + Ringe Piston + Segments Pistón Set Поршень и кольца			PISTON SET Kolben Set Set de Piston Pistón Set поршень	RINGS SET Kolben Set Segments de Piston Anillos Set кольца	PIN Pin Axe Perno Пин				
<b>350HC</b> 8 Cyl 101.6 mm Bore Ø 5,735 cc		Length: Outside Ø: Flange Ø: flange depth	Length: 81.0 Comp: 39.2 Height: -4.0			Top: 2.0 2nd: 2.0 3rd: 2.0 1st oil: 4.75 2nd oil:	Ø: 23.56 Length: 66.8					
								Reference no.:	Reference no.:	Reference no.:	Reference no.:	O-RING
NM-Germany Article no. Artikelnummer/ Modelo Número / статья НОМЕР	NM-Germany Article no.	NM-Germany Article no.	NM-Germany Article no.	NM-Germany Article no.	NM-Germany Article no.	NM-Germany Article no.	NM-Germany Article no.					
			KBSCH80138G	KBSCH80138G	KRCH80138G							

## GASOLINE

ENGINE TYPE Motortyp Type de Moteur Tipo de motor Тип двигателя	LINER KIT Liner Kit Kit de Chemise Camisas de los cilindros лайнер комплект	CYL. LINER Zylinderlaufbuchse Chemise Camisas de los cilindros втулка цилиндра	PISTON + RINGS Kolben + Ringe Piston + Segments Pistón Set Поршень и кольца			PISTON SET Kolben Set Set de Piston Pistón Set поршень	RINGS SET Kolben Set Segments de Piston Anillos Set кольца	PIN Pin Axe Perno Пин				
<b>350</b> 6/8 Cyl 101.6 mm Bore Ø 4,294 cc 5,735 cc		Length: Outside Ø: Flange Ø: flange depth	Length: 66.8 Comp: 39.6 Height: -1.85		skirt MOS2 treated	Top: 1.5 2nd: 1.5 3rd: 3.0 1st oil: 3.0 2nd oil:	Ø: 23.55 Length: 76.2					
								Reference no.:	Reference no.:	Reference no.:	Reference no.:	O-RING
								M-51786CP			12524205 HT-4860 HT-4862 M-51785CP	
NM-Germany Article no. Artikelnummer/ Modelo Número / статья НОМЕР	NM-Germany Article no.	NM-Germany Article no.	NM-Germany Article no.	NM-Germany Article no.	NM-Germany Article no.	NM-Germany Article no.	NM-Germany Article no.					
			KBSCH680139G KBSCH680139G KBSCH680139G	KBCH680139G KBCH680139G KBCH680139G	KRCH680139G KRCH680139G KRCH680139G							

## GASOLINE



ENGINE TYPE Motortyp Type de Moteur Tipo de motor Тип двигателя	LINER KIT Liner Kit Kit de Chemise Camisas de los cilindros лайнер комплект	CYL. LINER Zylinderlaufbuchse Chemise Camisas de los cilindros втулка цилиндра	PISTON + RINGS Kolben + Ringe Piston + Segments Pistón Set Поршень и кольца			PISTON SET Kolben Set Set de Piston Pistón Set поршень	RINGS SET Kolben Set Segments de Piston Anillos Set кольца	PIN Pin Axe Perno Пин				
<b>262 CID</b> <b>350 CID</b> 6/8 Cyl 101.6 mm Bore Ø 4,294 cc 5,735 cc		Length: Outside Ø: Flange Ø: flange depth	Length: 70.8 Comp: 39.1 Height: -2.0			Top: 2.0 2nd: 2.0 3rd: 2.0 1st oil: 4.75 2nd oil:	Ø: 23.55 Length: 76.0					
								Reference no.:	Reference no.:	Reference no.:	Reference no.:	O-RING
											10049073 10049076 10049079 10159424 12509282 12514101 12520264 14094004 14077448 14077948 3991488 6271097	HT-139 HT-5712 M-50564CP M-51684CP
NM-Germany Article no. Artikelnummer/ Modelo Número / статья НОМЕР	NM-Germany Article no.	NM-Germany Article no.	NM-Germany Article no.	NM-Germany Article no.	NM-Germany Article no.	NM-Germany Article no.	NM-Germany Article no.					
			KBSCH680140G KRCH680140G KRCH680140G	KBSCH680140G KBSCH680140G KBCH680140G	KBCH680140G KBCH680140G KRCH680140G							



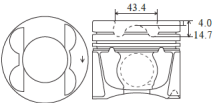

**DIESEL**

ENGINE TYPE Motortyp Type de Moteur Tipo de motor Тип двигателя	LINER KIT Liner Kit Kit de Chemise Camisas de los cilindros лайнер комплект	CYL. LINER Zylinderlaufbuchse Chemise Camisas de los cilindros штулка цилиндра	PISTON + RINGS Kolben + Ringe Piston + Segments Pistón Set Поршень и кольца			PISTON SET Kolben Set Set de Piston Pistón Set поршневой	RINGS SET Kolben Set Segments de Piston Anillos Set кольца	PIN Pin Axe Perno Пин
<b>L SERIES (395 CID)</b> 8 Cyl 102.98 mm Bore Ø 6,466 cc		Length: 38.1 Outside Ø: Flange Ø: flange depth	Length: 91.7 Comp: -1.2 Height: -3.7		alfin head anodized	Top: 3.0 double keystone 2nd: 2.0 3rd: 1st oil: 4.0 2nd oil:	Ø: 31.0 Length: 70.0	
		<b>Reference no.:</b>	<b>Reference no.:</b>	<b>Reference no.:</b>	<b>Reference no.:</b>	<b>O-RING</b>		
			<b>M-0270100</b>		<b>M-02701N0</b>			
NM-Germany Article no. Artikelnummer/ Modelo Número / статья НОМЕР	<b>NM-Germany Article no.</b>	<b>NM-Germany Article no.</b>	<b>NM-Germany Article no.</b>	<b>NM-Germany Article no.</b>	<b>NM-Germany Article no.</b>	<b>NM-Germany Article no.</b>	<b>NM-Germany Article no.</b>	
			<b>KBSCH80141DA</b>	<b>KBSCH80141G</b>	<b>KRCH80141G</b>			



## DIESEL

ENGINE TYPE	LINER KIT	CYL. LINER	PISTON + RINGS			PISTON SET	RINGS SET	PIN
Motortyp Type de Moteur Tipo de motor Тип двигателя	Liner Kit Kit de Chemise Camisas de los cilindros лайнер комплект	Zylinderlaufbuchse Chemise Camisas de los cilindros втулка цилиндра	Kolben + Ringe Piston + Segments Pistón Set Поршень и кольца			Kolben Set Set de Piston Pistón Set поршневой	Kolben Set Segments de Piston Anillos Set кольца	Pin Axe Perno Пин
<b>OM 642</b> 6 Cyl 83.0 mm Bore Ø 2,987 cc		Length: 45.7 Outside Ø: Flange Ø: flange depth	Length: 71.7 Comp: -4.0 Height: -14.7			alfin and with oil gallery skirt MOS2 treated	Top: 2.0 double key-stone 2nd: 2.0 3rd: 2.0 1st oil: 2.0 2nd oil:	Ø: 30.0 Length: 66.0
			Reference no.:	Reference no.:	Reference no.:	Reference no.:	O-RING	
				<b>K-40095600</b>		<b>K-800055820000</b> <b>M-00523N0</b>		
NM-Germany Article no. Artikelnummer/ Modelo Número / статья НОМЕР	NM-Germany Article no.	NM-Germany Article no.	NM-Germany Article no.	NM-Germany Article no.	NM-Germany Article no.	NM-Germany Article no.	NM-Germany Article no.	
			<b>KBSCS60142DB</b>	<b>KBCS60142DB</b> (for cyl 1/2/3)		<b>KRCS60142DB</b>		

## DIESEL

ENGINE TYPE	LINER KIT	CYL. LINER	PISTON + RINGS			PISTON SET	RINGS SET	PIN
Motortyp Type de Moteur Tipo de motor Тип двигателя	Liner Kit Kit de Chemise Camisas de los cilindros лайнер комплект	Zylinderlaufbuchse Chemise Camisas de los cilindros втулка цилиндра	Kolben + Ringe Piston + Segments Pistón Set Поршень и кольца			Kolben Set Set de Piston Pistón Set поршневой	Kolben Set Segments de Piston Anillos Set кольца	Pin Axe Perno Пин
<b>OM 642</b> 6 Cyl 83.0 mm Bore Ø 2,987 cc		Length: 45.7 Outside Ø: Flange Ø: flange depth	Length: 71.7 Comp: -4.0 Height: -14.7			alfin and with oil gallery skirt MOS2 treated	Top: 2.0 double key-stone 2nd: 2.0 3rd: 2.0 1st oil: 2.0 2nd oil:	Ø: 30.0 Length: 66.0
			Reference no.:	Reference no.:	Reference no.:	Reference no.:	O-RING	
				<b>K-40096600</b>		<b>K-800055820000</b> <b>M-00523N0</b>		
NM-Germany Article no. Artikelnummer/ Modelo Número / статья НОМЕР	NM-Germany Article no.	NM-Germany Article no.	NM-Germany Article no.	NM-Germany Article no.	NM-Germany Article no.	NM-Germany Article no.	NM-Germany Article no.	
			<b>KBSCS60143DB</b>	<b>KBCS60143DB</b> (for cyl 4/5/6)		<b>KRCS60143DB</b>		

## DIESEL

ENGINE TYPE	LINER KIT	CYL. LINER	PISTON + RINGS			PISTON SET	RINGS SET	PIN
Motortyp Type de Moteur Tipo de motor Тип двигателя	Liner Kit Kit de Chemise Camisas de los cilindros лайнер комплект	Zylinderlaufbuchse Chemise Camisas de los cilindros втулка цилиндра	Kolben + Ringe Piston + Segments Pistón Set Поршень и кольца			Kolben Set Set de Piston Pistón Set поршневой	Kolben Set Segments de Piston Anillos Set кольца	Pin Axe Perno Пин
<b>J8S 708</b> <b>J8S 814</b> <b>J8S 890</b> 4 Cyl 86.0 mm Bore Ø 2,068 cc	<b>A-ASA2525</b> <b>K-90436960</b> <b>M-0218492</b> <b>N-8933700000</b>	Length: 166.0 Outside Ø: Flange Ø: 93.6 collar depth 93.05	Length: 93.0 Comp: 51.0 Height: -4.0			alfin	Top: 2.5 double key-stone 2nd: 2.5 3rd: 4.0 1st oil: 4.0 2nd oil:	Ø: 28.0 Length: 75.0
			Reference no.:	Reference no.:	Reference no.:	Reference no.:	O-RING	
			<b>A-SJ351473</b> <b>G-1400032000</b> <b>K-89309110</b> <b>M-021WN29</b>	<b>K-90436600</b> <b>M-0218400</b>		<b>A-R66430</b> <b>G-0833700000</b> <b>K-800023540000</b> <b>M-02184N0</b>	<b>ORCS40144DA</b>	
NM-Germany Article no. Artikelnummer/ Modelo Número / статья НОМЕР	NM-Germany Article no.	NM-Germany Article no.	NM-Germany Article no.	NM-Germany Article no.	NM-Germany Article no.	NM-Germany Article no.	NM-Germany Article no.	
	<b>LBSCS40144DFA</b>	<b>LBCS40144DFA</b>	<b>KBSCS40144DA</b>	<b>KBCS40144DA</b>		<b>KRCS40144DA</b>		

GASOLINE

ENGINE TYPE Motortyp Type de Moteur Tipo de motor Тип двигателя	LINER KIT Liner Kit Kit de Chemise Camisas de los cilindros лайнер комплект	CYL. LINER Zylinderlaufbuchse Chemise Camisas de los cilindros втулка цилиндра	PISTON + RINGS Kolben + Ringe Piston + Segments Pistón Set Поршень и кольца		PISTON SET Kolben Set Set de Piston Pistón Set поршневой	RINGS SET Kolben Set Segments de Piston Anillos Set кольца	PIN Pin Axe Perno Пин
<b>L4 Neon 2.0 (SOHC 16V)</b> 4 Cyl 87.5 mm Bore Ø 1,993 cc		Length: Outside Ø: Flange Ø: flange depth	Length: 53.2 Comp: 31.2 Height: 0	skirt MOS2 treated	Top: 1.2 2nd: 1.2 3rd: 3.0 1st oil: 2nd oil:	Ø: 21.0 Length: 72.0	Reference no.:
							Reference no.:
							Reference no.: 031-05-14-A 316-04-11-A
							Reference no.:
							O-RING
NM-Germany Article no. Artikelnummer/ Modelo Número / статья НОМЕР	NM-Germany Article no.	NM-Germany Article no.	NM-Germany Article no.	NM-Germany Article no.	NM-Germany Article no.	NM-Germany Article no.	NM-Germany Article no.
			KBCS40145G	KBCS40145G	KRCS40145G		

CHRYSLER



GASOLINE

ENGINE TYPE Motortyp Type de Moteur Tipo de motor Тип двигателя	LINER KIT Liner Kit Kit de Chemise Camisas de los cilindros лайнер комплект	CYL. LINER Zylinderlaufbuchse Chemise Camisas de los cilindros втулка цилиндра	PISTON + RINGS Kolben + Ringe Piston + Segments Pistón Set Поршень и кольца		PISTON SET Kolben Set Set de Piston Pistón Set поршневой	RINGS SET Kolben Set Segments de Piston Anillos Set кольца	PIN Pin Axe Perno Пин
<b>EDZ</b> 4 Cyl 87.5 mm Bore Ø 2,429 cc		Length: Outside Ø: Flange Ø: flange depth	Length: 61.5 Comp: 31.4 Height: 5.5		Top: 1.5 2nd: 1.5 3rd: 3.0 1st oil: 2nd oil:	Ø: 22.0 Length: 73.0	Reference no.:
							Reference no.:
							Reference no.: 5073524AA HT- 2M4734 N-SWC10-007
							Reference no.:
							O-RING
NM-Germany Article no. Artikelnummer/ Modelo Número / статья НОМЕР	NM-Germany Article no.	NM-Germany Article no.	NM-Germany Article no.	NM-Germany Article no.	NM-Germany Article no.	NM-Germany Article no.	NM-Germany Article no.
			KBCS40146G	KBCS40146G	KRCS40146G		



GASOLINE

ENGINE TYPE Motortyp Type de Moteur Tipo de motor Тип двигателя	LINER KIT Liner Kit Kit de Chemise Camisas de los cilindros лайнер комплект	CYL. LINER Zylinderlaufbuchse Chemise Camisas de los cilindros втулка цилиндра	PISTON + RINGS Kolben + Ringe Piston + Segments Pistón Set Поршень и кольца		PISTON SET Kolben Set Set de Piston Pistón Set поршневой	RINGS SET Kolben Set Segments de Piston Anillos Set кольца	PIN Pin Axe Perno Пин
<b>EDZ</b> 4 Cyl 87.5 mm Bore Ø 2,429 cc		Length: Outside Ø: Flange Ø: flange depth	Length: 61.5 Comp: 30.4 Height: 6.5		Top: 1.2 2nd: 1.5 3rd: 3.0 1st oil: 2nd oil:	Ø: 22.0 Length: 72.6	Reference no.:
							Reference no.:
							Reference no.: 4897660AA
							Reference no.:
							O-RING
NM-Germany Article no. Artikelnummer/ Modelo Número / статья НОМЕР	NM-Germany Article no.	NM-Germany Article no.	NM-Germany Article no.	NM-Germany Article no.	NM-Germany Article no.	NM-Germany Article no.	NM-Germany Article no.
			KBCS40147G	KBCS40147G	KRCS40147G		



**GASOLINE**

ENGINE TYPE Motortyp Type de Moteur Tipo de motor Тип двигателя	LINER KIT Liner Kit Kit de Chemise Camisas de los cilindros лайнер комплект	CYL. LINER Zylinderlaufbuchse Chemise Camisas de los cilindros втулка цилиндра	PISTON + RINGS Kolben + Ringe Piston + Segments Pistón Set Поршень и кольца			PISTON SET Kolben Set Set de Piston Pistón Set поршневой	RINGS SET Kolben Set Segments de Piston Anillos Set кольца	PIN Pin Axe Perno Пин
<b>EDZ</b> 4 Cyl 87.5 mm Bore Ø 2,429 cc		Length: 66.2 Outside Ø: 30.2 Flange Ø: 11.5 flange depth	Length: 66.2 Comp: 30.2 Height: 11.5			Top: 1.5 2nd: 1.5 3rd: 3.0 1st oil: 3.0 2nd oil:	Ø: 22.0 Length: 73.0	
								Reference no.:
					<b>5066565AA</b>	<b>4773005</b> <b>5073524AA HT-</b> <b>2M4734</b> <b>N-SWC10-007</b>		
NM-Germany Article no. Artikelnummer/ Modelo Número / статья НОМЕР	NM-Germany Article no.	NM-Germany Article no.	NM-Germany Article no.	NM-Germany Article no.	NM-Germany Article no.	NM-Germany Article no.	NM-Germany Article no.	
			<b>KBSCS40148G</b>	<b>KBCS40148G</b>	<b>KRCS40148G</b>			

**DIESEL**

ENGINE TYPE Motortyp Type de Moteur Tipo de motor Тип двигателя	LINER KIT Liner Kit Kit de Chemise Camisas de los cilindros лайнер комплект	CYL. LINER Zylinderlaufbuchse Chemise Camisas de los cilindros втулка цилиндра	PISTON + RINGS Kolben + Ringe Piston + Segments Pistón Set Поршень и кольца			PISTON SET Kolben Set Set de Piston Pistón Set поршневой	RINGS SET Kolben Set Segments de Piston Anillos Set кольца	PIN Pin Axe Perno Пин
<b>HR TURBO</b> 4 Cyl 92.0 mm Bore Ø 2,499 cc	<b>A-ASA2460</b> <b>K-92286961</b> <b>K-92286971</b> <b>M-4891390</b> <b>N-8911010000</b>	Length: 168.0 Outside Ø: 103.0 Flange Ø: 110.0 flange depth	Length: 86.1 Comp: 51.1 Height: -2.3			Top: 2.5 double key-stone 2nd: 2.0 3rd: 4.0 1st oil: 4.0 2nd oil:	Ø: 30.0 Length: 75.5	
								Reference no.:
		<b>A-SJ351453</b> <b>G-1467642000</b> <b>K-89500110</b> <b>M-489WN01</b>	<b>K-92286600</b> <b>K-92286700</b> <b>M-4891300</b>			<b>A-R47730</b> <b>G-0811010000</b> <b>K-800000110000</b> <b>M-48912N0</b>	<b>ORCS40149DA</b>	
NM-Germany Article no. Artikelnummer/ Modelo Número / статья НОМЕР	NM-Germany Article no.	NM-Germany Article no.	NM-Germany Article no.	NM-Germany Article no.	NM-Germany Article no.	NM-Germany Article no.	NM-Germany Article no.	
	<b>LBSCS40149DFA</b>	<b>LBCS40149DFA</b>	<b>KBSCS40149DA</b>	<b>KBCS40149DA</b>	<b>KRCS40149DA</b>			

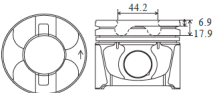
**DIESEL**



ENGINE TYPE Motortyp Type de Moteur Tipo de motor Тип двигателя	LINER KIT Liner Kit Kit de Chemise Camisas de los cilindros лайнер комплект	CYL. LINER Zylinderlaufbuchse Chemise Camisas de los cilindros втулка цилиндра	PISTON + RINGS Kolben + Ringe Piston + Segments Pistón Set Поршень и кольца			PISTON SET Kolben Set Set de Piston Pistón Set поршневой	RINGS SET Kolben Set Segments de Piston Anillos Set кольца	PIN Pin Axe Perno Пин
<b>ENC/ENJ</b> 4 Cyl 92.0 mm Bore Ø 2,499 cc		Length: 167.8 Outside Ø: 103.0 Flange Ø: 110.0 flange depth	Length: 79.0 Comp: 51.0 Height: -6.9			Top: 2.5 double key-stone 2nd: 1.5 3rd: 2.0 1st oil: 2.0 2nd oil:	Ø: 30.0 Length: 70.0	
								Reference no.:
						<b>G-0813410000</b>	<b>ORCS40150DB</b>	
NM-Germany Article no. Artikelnummer/ Modelo Número / статья НОМЕР	NM-Germany Article no.	NM-Germany Article no.	NM-Germany Article no.	NM-Germany Article no.	NM-Germany Article no.	NM-Germany Article no.	NM-Germany Article no.	
	<b>LBSCS40150DFB</b>	<b>LBCS40150DFB</b>	<b>KBSCS40150DB</b>	<b>KBCS40150DB</b>	<b>KRCS40150DB</b>			

GASOLINE

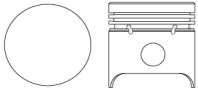

ENGINE TYPE Motortyp Type de Moteur Tipo de motor Тип двигателя	LINER KIT Liner Kit Kit de Chemise Camisas de los cilindros лайнер комплект	CYL. LINER Zylinderlaufbuchse Chemise Camisas de los cilindros втулка цилиндра	PISTON + RINGS Kolben + Ringe Piston + Segments Pistón Set Поршень и кольца		PISTON SET Kolben Set Set de Piston Pistón Set поршневой	RINGS SET Kolben Set Segments de Piston Anillos Set кольца	PIN Pin Axe Perno Пин			
<b>A 500 (287 CID)</b> <b>8 Cyl</b> <b>93.0 mm Bore Ø</b> <b>4,701 cc</b>		Length: Outside Ø: Flange Ø: flange depth	Length: 53.9 Comp: 31.8 Height: 0		skirt MOS2 treated	Top: 1.5 2nd: 1.5 3rd: 3.0 1st oil: 2nd oil:	Ø: 24.0 Length: 59.0			
						<b>Reference no.:</b>	<b>Reference no.:</b>	<b>Reference no.:</b>	<b>Reference no.:</b>	<b>O-RING</b>
								<b>5019316AA</b>	<b>N-SWC10-002</b>	
NM-Germany Article no. Artikelnummer/ Modelo Número / статья НОМЕР	<b>NM-Germany Article no.</b>	<b>NM-Germany Article no.</b>	<b>NM-Germany Article no.</b>	<b>NM-Germany Article no.</b>	<b>NM-Germany Article no.</b>	<b>NM-Germany Article no.</b>	<b>NM-Germany Article no.</b>			
			<b>KBCS80151G</b>	<b>KBCS80151G</b>	<b>KRCS80151G</b>					

CHRYSLER

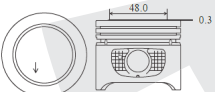

**GASOLINE**

ENGINE TYPE Motortyp Type de Moteur Tipo de motor Тип двигателя	LINER KIT Liner Kit Kit de Chemise Camisas de los cilindros лайнер комплект	CYL. LINER Zylinderlaufbuchse Chemise Camisas de los cilindros втулка цилиндра	PISTON + RINGS Kolben + Ringe Piston + Segments Pistón Set Поршень и кольца		PISTON SET Kolben Set Set de Piston Pistón Set поршневой		RINGS SET Kolben Set Segments de Piston Anillos Set кольца	PIN Pin Axe Perno Пин
<b>108 C XV 8</b> 4 Cyl 70.0 mm Bore Ø 954 cc  	<b>K-92511960 M-0390790</b>	Length: 122.0	Length: 73.3			Top: 2.0	Ø: 19.5 Length: 62.0	
		Outside Ø: 77.0	Comp: 44.55			2nd: 2.0		
		Flange Ø: 83.3	Height: 0			3rd: 4.0		
		collar depth 84.9				1st oil: 4.0		
			<b>Reference no.:</b>	<b>Reference no.:</b>	<b>Reference no.:</b>	<b>Reference no.:</b>	<b>O-RING</b>	
			<b>K-88651110 M-039WN01</b>	<b>K-92511600 M-0390700</b>		<b>A-R66100 G-0831730000 M-03907N0</b>	<b>ORCI40152G</b>	
NM-Germany Article no. Artikelnummer/ Modelo Número / статья НОМЕР	NM-Germany Article no.	NM-Germany Article no.	NM-Germany Article no.	NM-Germany Article no.	NM-Germany Article no.	NM-Germany Article no.	NM-Germany Article no.	NM-Germany Article no.
	<b>LBSCI40152GF</b>	<b>LBCI40152GF</b>	<b>KBSCI40152G</b>	<b>KBCI40152G</b>	<b>KRCI40152G</b>			

**GASOLINE**

ENGINE TYPE Motortyp Type de Moteur Tipo de motor Тип двигателя	LINER KIT Liner Kit Kit de Chemise Camisas de los cilindros лайнер комплект	CYL. LINER Zylinderlaufbuchse Chemise Camisas de los cilindros втулка цилиндра	PISTON + RINGS Kolben + Ringe Piston + Segments Pistón Set Поршень и кольца		PISTON SET Kolben Set Set de Piston Pistón Set поршневой		RINGS SET Kolben Set Segments de Piston Anillos Set кольца	PIN Pin Axe Perno Пин
<b>TU 9</b> 4 Cyl 70.0 mm Bore Ø 954 cc  	<b>A-SA2527 M-0396090</b>	Length: 122.0	Length: 58.3			Top: 1.5	Ø: 18.0 Length: 53.0	
		Outside Ø: 79.5	Comp: 34.0			2nd: 1.5		
		Flange Ø: 89.8	Height: 0.3			3rd: 3.0		
		collar depth 85.0				1st oil: 3.0		
			<b>Reference no.:</b>	<b>Reference no.:</b>	<b>Reference no.:</b>	<b>Reference no.:</b>	<b>O-RING</b>	
			<b>M-039WN27</b>	<b>A-PI4261300 K-91388600 M-0396000</b>		<b>A-R46910 A-R60850 G-0815420000 M-00726N0</b>	<b>ORCI40153G</b>	
NM-Germany Article no. Artikelnummer/ Modelo Número / статья НОМЕР	NM-Germany Article no.	NM-Germany Article no.	NM-Germany Article no.	NM-Germany Article no.	NM-Germany Article no.	NM-Germany Article no.	NM-Germany Article no.	NM-Germany Article no.
	<b>LBSCI40153GF</b>	<b>LBCI40153GF</b>	<b>KBSCI40153G</b>	<b>KBCI40153G</b>	<b>KRCI40153G</b>			

**DIESEL**

ENGINE TYPE Motortyp Type de Moteur Tipo de motor Тип двигателя	LINER KIT Liner Kit Kit de Chemise Camisas de los cilindros лайнер комплект	CYL. LINER Zylinderlaufbuchse Chemise Camisas de los cilindros втулка цилиндра	PISTON + RINGS Kolben + Ringe Piston + Segments Pistón Set Поршень и кольца		PISTON SET Kolben Set Set de Piston Pistón Set поршневой		RINGS SET Kolben Set Segments de Piston Anillos Set кольца	PIN Pin Axe Perno Пин
<b>8 HT/HX/HZ</b> 4 Cyl 73.7 mm Bore Ø 1,398 cc  		Length: 137.0	Length: 65.44			Top: 2.5	Ø: 25.0 Length: 60.0	
		Outside Ø: 76.78	Comp: 42.94			double key-stone		
		Flange Ø: 78.7	Height: -8.5			2nd: 1.95		
		flange depth 4.0				3rd: 2.5		
			<b>Reference no.:</b>	<b>Reference no.:</b>	<b>Reference no.:</b>	<b>Reference no.:</b>	<b>O-RING</b>	
				<b>A-A354118 K-40469600 M-0400300 N-8713530000</b>		<b>A-R66770 G-0813530000 K-800046040000 M-04005N0</b>		
NM-Germany Article no. Artikelnummer/ Modelo Número / статья НОМЕР	NM-Germany Article no.	NM-Germany Article no.	NM-Germany Article no.	NM-Germany Article no.	NM-Germany Article no.	NM-Germany Article no.	NM-Germany Article no.	NM-Germany Article no.
	<b>LBSCI40154DSA</b>	<b>LBCI40154DSA</b>	<b>KBSCI40154DA</b>	<b>KBCI40154DA</b>	<b>KRCI40154DA</b>			

## DIESEL

ENGINE TYPE	LINER KIT	CYL. LINER	PISTON + RINGS		PISTON SET	RINGS SET	PIN	
Motorotyp Type de Moteur Tipo de motor Тип двигателя	Liner Kit Kit de Chemise Camisas de los cilindros лайнер комплект	Zylindertaufbuchse Chemise Camisas de los cilindros втулка цилиндра	Kolben + Ringe Piston + Segments Pistón Set Поршень и кольца		Kolben Set Set de Piston Pistón Set поршневой	Kolben Set Segments de Piston Anillos Set кольца	Pin Axe Perno Пин	
<b>9 HX</b> <b>9 HY</b> <b>9 HZ</b> <b>4 Cyl</b> <b>75.0 mm Bore Ø</b> <b>1,560 cc</b>	<b>LBSCI40155DAP</b> consists of <b>LBCI40155DAP</b>  <b>LBSCI40155DAS</b> consists of <b>LBCI40155DAS</b>	(C)	(D)			alfin and with oil gallery	Top: 3.0	Ø: 26.0 Length: 61.0
		Length: 146.0	146.0	Length: 65.3		skirt MOS2 treated fits tapered con. rod	double keystone 2nd: 2.0 3rd: 2.5 1st oil: 2nd oil:	
		Outside Ø: 78.0	78.0	Comp: 41.7				
		Flange Ø: 79.0		Height: -6.0				
		flange depth	4.0	-13.2				
		<b>Reference no.:</b>	<b>Reference no.:</b>	<b>Reference no.:</b>	<b>Reference no.:</b>	<b>O-RING</b>		
				<b>A-A354125</b> <b>K-40179600</b> <b>M-0400600</b> <b>N-8742400000</b>		<b>G-0842400000</b> <b>K-800054940000</b> <b>M-04006N0</b>		
NM-Germany Article no. Artikelnummer/ Modelo Número / статья НОМЕР	NM-Germany Article no.	NM-Germany Article no.	NM-Germany Article no.	NM-Germany Article no.	NM-Germany Article no.	NM-Germany Article no.	NM-Germany Article no.	
	<b>LBSCI40155DAP</b> <b>LBSCI40155DAS</b>	<b>LBCI40155DAP (C)</b> <b>LBCI40155DAS (D)</b>	<b>KBSCI40155D</b>	<b>KBCI40155D</b>	<b>KRCI40155D</b>			

CITROEN

## GASOLINE

ENGINE TYPE	LINER KIT	CYL. LINER	PISTON + RINGS		PISTON SET	RINGS SET	PIN
Motorotyp Type de Moteur Tipo de motor Тип двигателя	Liner Kit Kit de Chemise Camisas de los cilindros лайнер комплект	Zylindertaufbuchse Chemise Camisas de los cilindros втулка цилиндра	Kolben + Ringe Piston + Segments Pistón Set Поршень и кольца		Kolben Set Set de Piston Pistón Set поршневой	Kolben Set Segments de Piston Anillos Set кольца	Pin Axe Perno Пин
<b>K1A-5A/KAY</b> <b>KDX/KFW/TU 32</b> <b>4 Cyl</b> <b>75.0 mm Bore Ø</b> <b>1,361 cc</b>	<b>A-SA2531</b> <b>K-94356960</b> <b>K-94356971</b> <b>M-0396490</b>	Length: 135.4		Length: 64.0		Top: 1.75	Ø: 19.5 Length: 62.0
		Outside Ø: 79.5		Comp: 40.4		2nd: 2.0	
		Flange Ø: 89.2		Height: -1.0		3rd: 3.0	
		collar depth	90.0			1st oil: 2nd oil:	
		<b>Reference no.:</b>	<b>Reference no.:</b>	<b>Reference no.:</b>	<b>Reference no.:</b>	<b>O-RING</b>	
		<b>K-89322110</b> <b>K-89584110</b> <b>M-021WN26</b>		<b>K-94356600</b> <b>K-94356700</b> <b>M-0396400</b>		<b>A-R60870</b> <b>G-0815440000</b> <b>K-800002941000</b> <b>M-03964N0</b>	<b>ORCI40156G</b>
NM-Germany Article no. Artikelnummer/ Modelo Número / статья НОМЕР	NM-Germany Article no.	NM-Germany Article no.	NM-Germany Article no.	NM-Germany Article no.	NM-Germany Article no.	NM-Germany Article no.	NM-Germany Article no.
	<b>LBSCI40156GF</b>	<b>LBCI40156GF</b>	<b>KBSCI40156G</b>	<b>KBCI40156G</b>	<b>KRCI40156G</b>		

## GASOLINE

ENGINE TYPE	LINER KIT	CYL. LINER	PISTON + RINGS		PISTON SET	RINGS SET	PIN
Motorotyp Type de Moteur Tipo de motor Тип двигателя	Liner Kit Kit de Chemise Camisas de los cilindros лайнер комплект	Zylindertaufbuchse Chemise Camisas de los cilindros втулка цилиндра	Kolben + Ringe Piston + Segments Pistón Set Поршень и кольца		Kolben Set Set de Piston Pistón Set поршневой	Kolben Set Segments de Piston Anillos Set кольца	Pin Axe Perno Пин
<b>KFV KFW</b> <b>4 Cyl</b> <b>75.0 mm Bore Ø</b> <b>1,361 cc</b>	<b>M-0400290</b>	Length: 135.4		Length: 48.8		Top: 1.5	Ø: 17.98 Length: 55.0
		Outside Ø: 79.5		Comp: 27.8		2nd: 1.5	
		Flange Ø: 89.2		Height: 0.2		3rd: 2.5	
		collar depth	90.0			1st oil: 2nd oil:	
		<b>Reference no.:</b>	<b>Reference no.:</b>	<b>Reference no.:</b>	<b>Reference no.:</b>	<b>O-RING</b>	
		<b>K-89322110</b> <b>K-89584110</b> <b>M-021WN26</b>		<b>A-24225</b> <b>M-0400200</b> <b>N-8713890030</b>		<b>A-R67020</b> <b>G-0813890000</b> <b>K-800043940000</b> <b>K-800043941000</b> <b>M-04002N0</b>	<b>ORCI40157G</b>
NM-Germany Article no. Artikelnummer/ Modelo Número / статья НОМЕР	NM-Germany Article no.	NM-Germany Article no.	NM-Germany Article no.	NM-Germany Article no.	NM-Germany Article no.	NM-Germany Article no.	NM-Germany Article no.
	<b>LBSCI40157GF</b>	<b>LBCI40157GF</b>	<b>KBSCI40157G</b>	<b>KBCI40157G</b>	<b>KRCI40157G</b>		

**DIESEL**

ENGINE TYPE Motortyp Type de Moteur Tipo de motor Тип двигателя	LINER KIT Liner Kit Kit de Chemise Camisas de los cilindros лайнер комплект	CYL. LINER Zylinderlaufbuchse Chemise Camisas de los cilindros втулка цилиндра	PISTON + RINGS Kolben + Ringe Piston + Segments Pistón Set Поршень и кольца		PISTON SET Kolben Set Set de Piston Pistón Set поршневой	RINGS SET Kolben Set Segments de Piston Anillos Set кольца	PIN Pin Axe Perno Пин
<b>TUD 5 VJX/VJY/ VJZ</b> 4 Cyl 77.0 mm Bore Ø 1,527 cc		Length: Outside Ø: Flange Ø: flange depth	STD	O/S		Top: 2.0 2nd: 1.75 3rd: 1st oil: 3.0 2nd oil:	Ø: 23.0 Length: 60.0
			Length: 66.32	66.32			
			Comp: 40.37	40.1			
			Height: -1.5	-1.5			
			flange depth	-2.4	-2.4		
			Reference no.:	Reference no.:	Reference no.:	Reference no.:	O-RING
				<b>K-94642700 M-0390100</b>		<b>A-R49960 G-0832580000 K-800036541000 M-03901N0</b>	
NM-Germany Article no. Artikelnummer/ Modelo Número / статья НОМЕР	NM-Germany Article no.	NM-Germany Article no.	NM-Germany Article no.	NM-Germany Article no.	NM-Germany Article no.	NM-Germany Article no.	NM-Germany Article no.
			<b>KBSCI40158D</b>	<b>KBCI40158D</b>	<b>KRCI40158D</b>		

**GASOLINE**

ENGINE TYPE Motortyp Type de Moteur Tipo de motor Тип двигателя	LINER KIT Liner Kit Kit de Chemise Camisas de los cilindros лайнер комплект	CYL. LINER Zylinderlaufbuchse Chemise Camisas de los cilindros втулка цилиндра	PISTON + RINGS Kolben + Ringe Piston + Segments Pistón Set Поршень и кольца		PISTON SET Kolben Set Set de Piston Pistón Set поршневой	RINGS SET Kolben Set Segments de Piston Anillos Set кольца	PIN Pin Axe Perno Пин
<b>NFU NFX</b> 4 Cyl 78.5 mm Bore Ø 1,587 cc		Length: Outside Ø: Flange Ø: flange depth	Length: 54.65			Top: 1.2 2nd: 1.5 3rd: 1st oil: 2.5 2nd oil:	Ø: 19.5 Length: 57.0
			Comp: 32.35				
			Height: 0.15				
			Reference no.:	Reference no.:	Reference no.:	Reference no.:	O-RING
				<b>K-40161600 M-0400400 M-S44000</b>	<b>M-E44000 M-P9126</b>	<b>A-R67250 G-0813940000 K-800050940000 M-04004N0 M-A44500</b>	
NM-Germany Article no. Artikelnummer/ Modelo Número / статья НОМЕР	NM-Germany Article no.	NM-Germany Article no.	NM-Germany Article no.	NM-Germany Article no.	NM-Germany Article no.	NM-Germany Article no.	NM-Germany Article no.
			<b>KBSCI40159G</b>	<b>KBCI40159G</b>	<b>KRCI40159G</b>		

**GASOLINE**

ENGINE TYPE Motortyp Type de Moteur Tipo de motor Тип двигателя	LINER KIT Liner Kit Kit de Chemise Camisas de los cilindros лайнер комплект	CYL. LINER Zylinderlaufbuchse Chemise Camisas de los cilindros втулка цилиндра	PISTON + RINGS Kolben + Ringe Piston + Segments Pistón Set Поршень и кольца		PISTON SET Kolben Set Set de Piston Pistón Set поршневой	RINGS SET Kolben Set Segments de Piston Anillos Set кольца	PIN Pin Axe Perno Пин
<b>NFZ</b> 4 Cyl 78.5 mm Bore Ø 1,587 cc		Length: Outside Ø: Flange Ø: flange depth	Length: 57.5			Top: 1.5 2nd: 1.5 3rd: 1st oil: 3.0 2nd oil:	Ø: 19.5 Length: 62.0
			Comp: 32.4				
			Height: -1.5				
			Reference no.:	Reference no.:	Reference no.:	Reference no.:	O-RING
				<b>M-0318800</b>		<b>G-0810380000 M-04008V0</b>	
NM-Germany Article no. Artikelnummer/ Modelo Número / статья НОМЕР	NM-Germany Article no.	NM-Germany Article no.	NM-Germany Article no.	NM-Germany Article no.	NM-Germany Article no.	NM-Germany Article no.	NM-Germany Article no.
			<b>KBSCI40160G</b>	<b>KBCI40160G</b>	<b>KRCI40160G</b>		







**DIESEL**

ENGINE TYPE Motortyp Type de Moteur Tipo de motor Тип двигателя	LINER KIT Liner Kit Kit de Chemise Camisas de los cilindros лайнер комплект	CYL. LINER Zylinderlaufbuchse Chemise Camisas de los cilindros втулка цилиндра	PISTON + RINGS Kolben + Ringe Piston + Segments Pistón Set Поршень и кольца		PISTON SET Kolben Set Set de Piston Pistón Set поршень	RINGS SET Kolben Set Segments de Piston Anillos Set кольца	PIN Pin Axe Perno Пин
<b>162/D9A D9B/ DJY/DJZ</b> 4 Cyl 83.0 mm Bore Ø 1,905 cc	(A) <b>K-93648970 M-0392490</b> consists of (C)  (B) <b>M-0392491</b> consists of (D)	Length: 153.5 153.5 Outside Ø: 86.0 86.0 Flange Ø: 89.0 flange depth 4.8	Length: 84.3 Comp: 46.8 Height: -2.2		Top: 2.0 2nd: 2.0 3rd: 2.0 1st oil: 3.0 2nd oil:	Ø: 25.0 Length: 72.0	
		Reference no.:	Reference no.:	Reference no.:	Reference no.:	O-RING	
		<b>K-89184190 (C) M-039WV21 (C) M-039WV32 (D)</b>	<b>A-350709 K-93648700 M-0392400 N-8715200010</b>		<b>A-R66390 G-081520000 K-800003740000 M-03924N0</b>		
NM-Germany Article no. Artikelnummer/ Modelo Número / статья НОМЕР	NM-Germany Article no.	NM-Germany Article no.	NM-Germany Article no.	NM-Germany Article no.	NM-Germany Article no.	NM-Germany Article no.	NM-Germany Article no.
	<b>LBSCI40164DP (A) LBSCI40164DS (B)</b>	<b>LBCI40164DP (C) LBCI40164DS (D)</b>	<b>KBSCI40164D</b>	<b>KBCI40164D</b>	<b>KRCI40164D</b>		

**DIESEL**

ENGINE TYPE Motortyp Type de Moteur Tipo de motor Тип двигателя	LINER KIT Liner Kit Kit de Chemise Camisas de los cilindros лайнер комплект	CYL. LINER Zylinderlaufbuchse Chemise Camisas de los cilindros втулка цилиндра	PISTON + RINGS Kolben + Ringe Piston + Segments Pistón Set Поршень и кольца		PISTON SET Kolben Set Set de Piston Pistón Set поршень	RINGS SET Kolben Set Segments de Piston Anillos Set кольца	PIN Pin Axe Perno Пин
<b>D8B/D8C DHV/ DHW DHX/DHY</b> 4 Cyl 83.0 mm Bore Ø 1,905 cc		Length: 46.8 Outside Ø: Flange Ø: flange depth	Length: 79.3 79.3 Comp: -3.5 Height: 46.65 -3.5	STD O/S alfin head anodized skirt MOS2 treated fits tapered con. rod	Top: 3.0 double key- stone 2nd: 2.0 3rd: 3.0 1st oil: 2nd oil:	Ø: 28.0 Length: 68.0	
		Reference no.:	Reference no.:	Reference no.:	Reference no.:	O-RING	
			<b>A-A350520 K-94786700 M-0399600 N-8710550000</b>		<b>A-R60140 G-0810550000 M-03996N0</b>		
NM-Germany Article no. Artikelnummer/ Modelo Número / статья НОМЕР	NM-Germany Article no.	NM-Germany Article no.	NM-Germany Article no.	NM-Germany Article no.	NM-Germany Article no.	NM-Germany Article no.	NM-Germany Article no.
			<b>KBSCI40165DA</b>	<b>KBCI40165DA</b>	<b>KRCI40165DA</b>		

**GASOLINE**

ENGINE TYPE Motortyp Type de Moteur Tipo de motor Тип двигателя	LINER KIT Liner Kit Kit de Chemise Camisas de los cilindros лайнер комплект	CYL. LINER Zylinderlaufbuchse Chemise Camisas de los cilindros втулка цилиндра	PISTON + RINGS Kolben + Ringe Piston + Segments Pistón Set Поршень и кольца		PISTON SET Kolben Set Set de Piston Pistón Set поршень	RINGS SET Kolben Set Segments de Piston Anillos Set кольца	PIN Pin Axe Perno Пин
<b>B2C XU 52 C</b> 4 Cyl 83.0 mm Bore Ø 1,581 cc	<b>A-SA2518 K-91017960 M-0398190 N-8915120000</b>	Length: 141.0 Outside Ø: 97.0 Flange Ø: collar depth 95.19	Length: 67.5 Comp: 37.5 Height: -2.8		Top: 1.75 2nd: 1.75 3rd: 1.75 1st oil: 4.0 2nd oil:	Ø: 22.0 Length: 62.0	
		Reference no.:	Reference no.:	Reference no.:	Reference no.:	O-RING	
		<b>A-SJ4327 G-1463491000 K-89301110 M-039WN24</b>	<b>K-91017600 M-0398100</b>		<b>A-R60940 G-0815120000 K-800003640000 M-03976N0</b>	<b>ORCI40166G</b>	
NM-Germany Article no. Artikelnummer/ Modelo Número / статья НОМЕР	NM-Germany Article no.	NM-Germany Article no.	NM-Germany Article no.	NM-Germany Article no.	NM-Germany Article no.	NM-Germany Article no.	NM-Germany Article no.
	<b>LBSCI40166GF</b>	<b>LBCI40166GF</b>	<b>KBSCI40166G</b>	<b>KBCI40166G</b>	<b>KRCI40166G</b>		

## GASOLINE

ENGINE TYPE Motortyp Type de Moteur Tipo de motor Тип двигателя	LINER KIT Liner Kit Kit de Chemise Camisas de los cilindros лайнер комплект	CYL. LINER Zylinderlaufbuchse Chemise Camisas de los cilindros втулка цилиндра	PISTON + RINGS Kolben + Ringe Piston + Segments Pistón Set Поршень и кольца			PISTON SET Kolben Set Set de Piston Pistón Set поршневой	RINGS SET Kolben Set Segments de Piston Anillos Set кольца	PIN Pin Axe Perno Пин
<b>D61/D2A/D6E</b> <b>XU 9J2</b> <b>XU 9JA</b> 4 Cyl 83.0 mm Bore Ø 1,905 cc	<b>A-SA2517</b> <b>K-90382970</b> <b>M-0397990</b> <b>N-8932240000</b>	Length: 141.0 Outside Ø: 88.6 Flange Ø: 97.0 collar depth 95.19	Length: 67.5 Comp: 37.5 Height: -9.0			Top: 1.5 2nd: 1.5 3rd: 1.5 1st oil: 4.0 2nd oil:	Ø: 22.0 Length: 62.0	
		Reference no.:	Reference no.:	Reference no.:	Reference no.:	O-RING		
		<b>A-SJ4327</b> <b>G-1463491000</b> <b>K-89301110</b> <b>M-039WN24</b>	<b>K-90382700</b> <b>M-0397900</b>		<b>A-R60950</b> <b>G-0832240000</b> <b>K-800003541000</b> <b>M-03980N0</b>	<b>ORCI40167G</b>		
NM-Germany Article no. Artikelnummer/ Modelo Número / статья НОМЕР	NM-Germany Article no.	NM-Germany Article no.	NM-Germany Article no.	NM-Germany Article no.	NM-Germany Article no.	NM-Germany Article no.	NM-Germany Article no.	
	LBSCI40167GF	LBCI40167GF	KBSCI40167G	KBCI40167G	KRCI40167G			

CITROEN

## GASOLINE

ENGINE TYPE Motortyp Type de Moteur Tipo de motor Тип двигателя	LINER KIT Liner Kit Kit de Chemise Camisas de los cilindros лайнер комплект	CYL. LINER Zylinderlaufbuchse Chemise Camisas de los cilindros втулка цилиндра	PISTON + RINGS Kolben + Ringe Piston + Segments Pistón Set Поршень и кольца			PISTON SET Kolben Set Set de Piston Pistón Set поршневой	RINGS SET Kolben Set Segments de Piston Anillos Set кольца	PIN Pin Axe Perno Пин
<b>L6A/LFW</b> <b>LFX/LFZ</b> 4 Cyl 83.0 mm Bore Ø 1,761 cc	<b>A-SA2423</b> <b>K-94351960</b> <b>K-94351970</b> <b>M-0398792</b>	Length: 141.0 Outside Ø: 88.6 Flange Ø: 97.0 collar depth 95.19	Length: 53.4 Comp: 33.4 Height: -4.2			Top: 1.5 2nd: 1.5 3rd: 1.5 1st oil: 3.0 2nd oil:	Ø: 22.0 Length: 62.0	
		Reference no.:	Reference no.:	Reference no.:	Reference no.:	O-RING		
		<b>A-SJ4327</b> <b>G-1463491000</b> <b>K-89301110</b> <b>M-039WN24</b>	<b>A-24142</b> <b>K-94351600</b> <b>K-94351700</b> <b>M-0398700</b>		<b>A-R60190</b> <b>G-0832340000</b> <b>K-800003441000</b> <b>M-03982V0</b> <b>T-50014</b>	<b>ORCI40168G</b>		
NM-Germany Article no. Artikelnummer/ Modelo Número / статья НОМЕР	NM-Germany Article no.	NM-Germany Article no.	NM-Germany Article no.	NM-Germany Article no.	NM-Germany Article no.	NM-Germany Article no.	NM-Germany Article no.	
	LBSCI40168GF	LBCI40168GF	KBSCI40168G	KBCI40168G	KRCI40168G			

## GASOLINE

ENGINE TYPE Motortyp Type de Moteur Tipo de motor Тип двигателя	LINER KIT Liner Kit Kit de Chemise Camisas de los cilindros лайнер комплект	CYL. LINER Zylinderlaufbuchse Chemise Camisas de los cilindros втулка цилиндра	PISTON + RINGS Kolben + Ringe Piston + Segments Pistón Set Поршень и кольца			PISTON SET Kolben Set Set de Piston Pistón Set поршневой	RINGS SET Kolben Set Segments de Piston Anillos Set кольца	PIN Pin Axe Perno Пин
<b>LFY</b> 4 Cyl 83.0 mm Bore Ø 1,762 cc	<b>K-94742970</b> <b>M-0396690</b>	Length: 141.0 Outside Ø: 88.6 Flange Ø: 97.0 collar depth 95.19	Length: 56.4 Comp: 33.4 Height: -1.1			Top: 1.5 2nd: 1.5 3rd: 1.5 1st oil: 3.0 2nd oil:	Ø: 22.0 Length: 62.0	
		Reference no.:	Reference no.:	Reference no.:	Reference no.:	O-RING		
		<b>A-SJ4327</b> <b>G-1463491000</b> <b>K-89301110</b> <b>M-039WN24</b>	<b>K-94742700</b> <b>M-0396600</b>		<b>G-0832340000</b> <b>K-800003441000</b> <b>M-03982V0</b> <b>T-50014</b>	<b>ORCI40169G</b>		
NM-Germany Article no. Artikelnummer/ Modelo Número / статья НОМЕР	NM-Germany Article no.	NM-Germany Article no.	NM-Germany Article no.	NM-Germany Article no.	NM-Germany Article no.	NM-Germany Article no.	NM-Germany Article no.	
	LBSCI40169GF	LBCI40169GF	KBSCI40169G	KBCI40169G	KRCI40169G			



**DIESEL**

ENGINE TYPE	LINER KIT	CYL. LINER	PISTON + RINGS			PISTON SET	RINGS SET	PIN
Motortyp Type de Moteur Tipo de motor Тип двигателя	Liner Kit Kit de Chemise Camisas de los cilindros лайнер комплект	Zylinderlaufbuchse Chemise Camisas de los cilindros штулка цилиндра	Kolben + Ringe Piston + Segments Pistón Set Поршень и кольца			Kolben Set Set de Piston Pistón Set поршневой	Kolben Set Segments de Piston Anillos Set кольца	Pin Axe Perno Пин
<b>DW10 BTED4 RHR</b> 4 Cyl 85.0 mm Bore Ø 1,997 cc	<b>K-99700600</b> <b>A-R60410</b> <b>G-0811470000</b> <b>K-800045940000</b> <b>M-03999N0</b>	Length: 165.0	Length: 80.7		alfin and with oil gallery skirt MOS2 treated fits tapered con. rod	Top: 3.5	Ø: 28.0 Length: 70.0	
		Outside Ø: 89.06	Comp: 46.7			2nd: 2.0		
		Flange Ø: 91.0	Height: -4.7			3rd: 2.0		
		flange depth 4.5		-15.4		1st oil: 3.0		
			Reference no.:	Reference no.:	Reference no.:	Reference no.:	O-RING	
NM-Germany Article no. Artikelnummer/ Modelo Número / статья НОМЕР	NM-Germany Article no.	NM-Germany Article no.	NM-Germany Article no.	NM-Germany Article no.	NM-Germany Article no.	NM-Germany Article no.	NM-Germany Article no.	
	LBSCI40173DSB	LBCI40173DSB	KBSCI40173DB	KBCI40173DB	KRCI40173DB			

CITROEN



**DIESEL**

ENGINE TYPE	LINER KIT	CYL. LINER	PISTON + RINGS			PISTON SET	RINGS SET	PIN
Motortyp Type de Moteur Tipo de motor Тип двигателя	Liner Kit Kit de Chemise Camisas de los cilindros лайнер комплект	Zylinderlaufbuchse Chemise Camisas de los cilindros штулка цилиндра	Kolben + Ringe Piston + Segments Pistón Set Поршень и кольца			Kolben Set Set de Piston Pistón Set поршневой	Kolben Set Segments de Piston Anillos Set кольца	Pin Axe Perno Пин
<b>4HW 4HX</b> 4 Cyl 85.0 mm Bore Ø 2,179 cc	<b>K-40406600</b> <b>A-R60410</b> <b>G-0811470000</b> <b>K-800045940000</b> <b>M-03999N0</b>	Length: 165.0	Length: 77.7		alfin and with oil gallery skirt MOS2 treated	Top: 3.5	Ø: 30.0 Length: 68.0	
		Outside Ø: 89.06	Comp: 48.7			2nd: 2.0		
		Flange Ø: 91.0	Height: -9.8			3rd: 3.0		
		flange depth 4.5		-18.0		1st oil: 3.0		
			Reference no.:	Reference no.:	Reference no.:	Reference no.:	O-RING	
NM-Germany Article no. Artikelnummer/ Modelo Número / статья НОМЕР	NM-Germany Article no.	NM-Germany Article no.	NM-Germany Article no.	NM-Germany Article no.	NM-Germany Article no.	NM-Germany Article no.	NM-Germany Article no.	
	LBSCI40174DSB	LBCI40174DSB	KBSCI40174DB	KBCI40174DB	KRCI40174DB			



**DIESEL**

ENGINE TYPE	LINER KIT	CYL. LINER	PISTON + RINGS			PISTON SET	RINGS SET	PIN
Motortyp Type de Moteur Tipo de motor Тип двигателя	Liner Kit Kit de Chemise Camisas de los cilindros лайнер комплект	Zylinderlaufbuchse Chemise Camisas de los cilindros штулка цилиндра	Kolben + Ringe Piston + Segments Pistón Set Поршень и кольца			Kolben Set Set de Piston Pistón Set поршневой	Kolben Set Segments de Piston Anillos Set кольца	Pin Axe Perno Пин
<b>4HY</b> 4 Cyl 85.0 mm Bore Ø 2,179 cc	<b>K-40405600</b> <b>M-0402200</b>	Length: 165.0	Length: 77.7		alfin skirt MOS2 treated	Top: 3.5	Ø: 30.0 Length: 68.0	
		Outside Ø: 89.06	Comp: 48.7			2nd: 2.0		
		Flange Ø: 91.0	Height: -1.2			3rd: 3.0		
		flange depth 4.5		-17.7		1st oil: 3.0		
			Reference no.:	Reference no.:	Reference no.:	Reference no.:	O-RING	
NM-Germany Article no. Artikelnummer/ Modelo Número / статья НОМЕР	NM-Germany Article no.	NM-Germany Article no.	NM-Germany Article no.	NM-Germany Article no.	NM-Germany Article no.	NM-Germany Article no.	NM-Germany Article no.	
	LBSCI40175DSA	LBCI40175DSA	KBSCI40175DA	KBCI40175DA	KRCI40175DA			

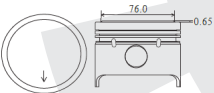

**GASOLINE**

ENGINE TYPE Motortyp Type de Moteur Tipo de motor Тип двигателя	LINER KIT Liner Kit Kit de Chemise Camisas de los cilindros лайнер комплект	CYL. LINER Zylinderlaufbuchse Chemise Camisas de los cilindros втулка цилиндра	PISTON + RINGS Kolben + Ringe Piston + Segments Pistón Set Поршень и кольца		PISTON SET Kolben Set Set de Piston Pistón Set поршневой	RINGS SET Kolben Set Segments de Piston Anillos Set кольца	PIN Pin Axe Perno Пин
<b>RFJ</b> 4 Cyl 85.0 mm Bore Ø 1,997 cc 		Length:		Length:	50.9	skirt MOS2 treated fits tapered con. rod Top: 1.2 2nd: 1.5 3rd: 1.5 1st oil: 2.5 2nd oil: 2.5	Ø: 21.0 Length: 56.0
		Outside Ø:		Comp:	29.0		
		Flange Ø:		Height:	0.15		
		flange depth			-3.8		
		Reference no.:		Reference no.:		Reference no.:	O-RING
				<b>K-40273600</b>		<b>K-800059240000</b> <b>M-04016N0</b>	
NM-Germany Article no. Artikelnummer/ Modelo Número / статья НОМЕР	NM-Germany Article no.	NM-Germany Article no.	NM-Germany Article no.	NM-Germany Article no.	NM-Germany Article no.	NM-Germany Article no.	NM-Germany Article no.
			<b>KBSCI40176G</b>	<b>KBCI40176G</b>	<b>KRCI40176G</b>		



**GASOLINE**

ENGINE TYPE Motortyp Type de Moteur Tipo de motor Тип двигателя	LINER KIT Liner Kit Kit de Chemise Camisas de los cilindros лайнер комплект	CYL. LINER Zylinderlaufbuchse Chemise Camisas de los cilindros втулка цилиндра	PISTON + RINGS Kolben + Ringe Piston + Segments Pistón Set Поршень и кольца		PISTON SET Kolben Set Set de Piston Pistón Set поршневой	RINGS SET Kolben Set Segments de Piston Anillos Set кольца	PIN Pin Axe Perno Пин
<b>XN 1T/1TA</b> <b>170 A/B/C/D</b> 4 Cyl 88.0 mm Bore Ø 1,971 cc 	<b>A-SA2494</b> <b>K-93908960</b>	Length:	135.5	Length:	71.75	Top: 1.5 2nd: 2.0 3rd: 2.0 1st oil: 4.0 2nd oil: 4.0	Ø: 23.0 Length: 74.0
		Outside Ø:	101.9	Comp:	38.25		
		Flange Ø:		Height:	0.65		
		collar depth	90.0				
		Reference no.:		Reference no.:		Reference no.:	O-RING
				<b>K-88589110</b> <b>M-039WN13</b>	<b>K-93908600</b>	<b>A-R66110</b> <b>K-800003841000</b> <b>M-03953N0</b> <b>T-50023</b>	<b>ORCI40177G</b>
NM-Germany Article no. Artikelnummer/ Modelo Número / статья НОМЕР	NM-Germany Article no.	NM-Germany Article no.	NM-Germany Article no.	NM-Germany Article no.	NM-Germany Article no.	NM-Germany Article no.	NM-Germany Article no.
	<b>LBSCI40177GF</b>	<b>LBCI40177GF</b>	<b>KBSCI40177G</b>	<b>KBCI40177G</b>	<b>KRCI40177G</b>	<b>K-50006663</b>	

**DIESEL**

ENGINE TYPE Motortyp Type de Moteur Tipo de motor Тип двигателя	LINER KIT Liner Kit Kit de Chemise Camisas de los cilindros лайнер комплект	CYL. LINER Zylinderlaufbuchse Chemise Camisas de los cilindros втулка цилиндра	PISTON + RINGS Kolben + Ringe Piston + Segments Pistón Set Поршень и кольца		PISTON SET Kolben Set Set de Piston Pistón Set поршневой	RINGS SET Kolben Set Segments de Piston Anillos Set кольца	PIN Pin Axe Perno Пин
<b>T8A</b> <b>THY</b> <b>THZ</b> 4 Cyl 92.0 mm Bore Ø 2,446 cc 		Length:	49.84	Length:	STD 82.0 O/S 81.6	Top: 3.0 double key-stone 2nd: 1.75 3rd: 1.75 1st oil: 3.5 2nd oil: 3.5	Ø: 34.0 Length: 68.0
		Outside Ø:		Comp:	-2.3		
		Flange Ø:		Height:	49.47		
		flange depth			-2.3		
		Reference no.:		Reference no.:		Reference no.:	O-RING
				<b>A-A354071</b> <b>K-91313700</b> <b>M-0390600</b>		<b>A-R67430</b> <b>G-0832630000</b> <b>K-800059940000</b> <b>M-03906N0</b>	
NM-Germany Article no. Artikelnummer/ Modelo Número / статья НОМЕР	NM-Germany Article no.	NM-Germany Article no.	NM-Germany Article no.	NM-Germany Article no.	NM-Germany Article no.	NM-Germany Article no.	NM-Germany Article no.
			<b>KBSCI40178DB</b>	<b>KBCI40178DB</b>	<b>KRCI40178DB</b>		

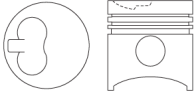
DIESEL

ENGINE TYPE Motortyp Type de Moteur Tipo de motor Тип двигателя	LINER KIT Liner Kit Kit de Chemise Camisas de los cilindros лайнер комплект	CYL. LINER Zylinderlaufbuchse Chemise Camisas de los cilindros штулка цилиндра	PISTON + RINGS Kolben + Ringe Piston + Segments Pistón Set Поршень и кольца			PISTON SET Kolben Set Set de Piston Pistón Set поршневой	RINGS SET Kolben Set Segments de Piston Anillos Set кольца	PIN Pin Axe Perno Пин
<b>B 25</b> <b>CRD 93</b> <b>M 22/M 25/U25</b>  <b>4 Cyl</b> <b>93.01 mm Bore Ø</b> <b>2,499 cc</b>  	<b>K-93844970</b> <b>M-0318290</b>	Length: 163.0 Outside Ø: 97.5 Flange Ø: 99.0 flange depth: 5.0	Length: 95.0 Comp: 52.75 Height: -7.4			Top: 2.5 2nd: 2.0 3rd: 2.0 1st oil: 4.0 2nd oil: 4.0	Ø: 30.0 Length: 78.0	
		<b>Reference no.:</b>	<b>Reference no.:</b>	<b>Reference no.:</b>	<b>Reference no.:</b>	<b>O-RING</b>		
		<b>K-89073190</b> <b>M-031WV16</b>	<b>A-350704</b> <b>K-93844700</b> <b>M-0318200</b> <b>N-8715270000</b>		<b>A-R60970</b> <b>G-0815270000</b> <b>K-800004041000</b> <b>M-03182N0</b>			
NM-Germany Article no. Artikelnummer/ Modelo Número / статья НОМЕР	NM-Germany Article no.	NM-Germany Article no.	NM-Germany Article no.	NM-Germany Article no.	NM-Germany Article no.	NM-Germany Article no.	NM-Germany Article no.	
	<b>LBSCI40179DS</b>	<b>LBCI40179DS</b>	<b>KBSCI40179D</b>	<b>KBCI40179D</b>	<b>KRCI40179D</b>			

CITROEN

**GASOLINE**

ENGINE TYPE Motortyp Type de Moteur Tipo de motor Тип двигателя	LINER KIT Liner Kit Kit de Chemise Camisas de los cilindros лайнер комплект	CYL. LINER Zylinderlaufbuchse Chemise Camisas de los cilindros втулка цилиндра	PISTON + RINGS Kolben + Ringe Piston + Segments Pistón Set Поршень и кольца			PISTON SET Kolben Set Set de Piston Pistón Set поршневой	RINGS SET Kolben Set Segments de Piston Anillos Set кольца	PIN Pin Axe Perno Пин			
<b>100 G/GB/GC</b> <b>100 GF/GL/GL3</b> 4 Cyl 65.0 mm Bore Ø 843 cc 903 cc		Length: Outside Ø: Flange Ø: flange depth	Length: 61.2 Comp: 30.7 Height: 0			Top: 1.75 2nd: 2.0 3rd: 1st oil: 3.94 2nd oil:	Ø: 20.0 Length: 54.0				
						Reference no.:		Reference no.:	Reference no.:	Reference no.:	O-RING
						A-24165 K-90451700 M-0072000 N-8720980000		5 880 462 5 880 463 5 880 464 5 880 466	5 881 661 A-R46550 G-0820980000 K-800005641000 M-00720N0		
NM-Germany Article no. Artikelnummer/ Modelo Número / статья НОМЕР	NM-Germany Article no.	NM-Germany Article no.	NM-Germany Article no.	NM-Germany Article no.	NM-Germany Article no.	NM-Germany Article no.	NM-Germany Article no.				
			KBSFI40184G	KBFI40184G	KRFI40184G						

**GASOLINE**

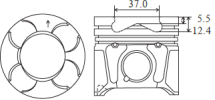

ENGINE TYPE Motortyp Type de Moteur Tipo de motor Тип двигателя	LINER KIT Liner Kit Kit de Chemise Camisas de los cilindros лайнер комплект	CYL. LINER Zylinderlaufbuchse Chemise Camisas de los cilindros втулка цилиндра	PISTON + RINGS Kolben + Ringe Piston + Segments Pistón Set Поршень и кольца			PISTON SET Kolben Set Set de Piston Pistón Set поршневой	RINGS SET Kolben Set Segments de Piston Anillos Set кольца	PIN Pin Axe Perno Пин			
<b>100 GL6</b> 4 Cyl 65.0 mm Bore Ø 843 cc		Length: Outside Ø: Flange Ø: flange depth	Length: 63.0 Comp: 32.5 Height: 0			Top: 1.75 2nd: 2.0 3rd: 1st oil: 3.94 2nd oil:	Ø: 20.0 Length: 55.0				
						Reference no.:		Reference no.:	Reference no.:	Reference no.:	O-RING
						K-92914600 M-0072200			5 881 661 A-R46550 G-0820980000 K-800005641000 M-00720N0		
NM-Germany Article no. Artikelnummer/ Modelo Número / статья НОМЕР	NM-Germany Article no.	NM-Germany Article no.	NM-Germany Article no.	NM-Germany Article no.	NM-Germany Article no.	NM-Germany Article no.	NM-Germany Article no.				
			KBSFI40185G	KBFI40185G	KRFI40185G						

**DIESEL**

ENGINE TYPE Motortyp Type de Moteur Tipo de motor Тип двигателя	LINER KIT Liner Kit Kit de Chemise Camisas de los cilindros лайнер комплект	CYL. LINER Zylinderlaufbuchse Chemise Camisas de los cilindros втулка цилиндра	PISTON + RINGS Kolben + Ringe Piston + Segments Pistón Set Поршень и кольца			PISTON SET Kolben Set Set de Piston Pistón Set поршневой	RINGS SET Kolben Set Segments de Piston Anillos Set кольца	PIN Pin Axe Perno Пин			
<b>188 A8/A9</b> <b>199 A2</b> <b>M 733 AT.12.Z</b> 4 Cyl 69.6 mm Bore Ø 1,248 cc 1,251 cc		Length: Outside Ø: Flange Ø: flange depth	Length: 63.43 Comp: 40.43 Height: -5.5 -12.4		alfin skirt MOS2 treated fits tapered con. rod	Top: 2.0 2nd: 1.5 3rd: 1st oil: 2.0 2nd oil:	Ø: 23.0 Length: 56.5				
						Reference no.:		Reference no.:	Reference no.:	Reference no.:	O-RING
						A-A354085 K-40213600 M-0100400 N-8713760000		7 172 8500	A-R66830 G-0813760000 K-800056240000 M-01004N0		
NM-Germany Article no. Artikelnummer/ Modelo Número / статья НОМЕР	NM-Germany Article no.	NM-Germany Article no.	NM-Germany Article no.	NM-Germany Article no.	NM-Germany Article no.	NM-Germany Article no.	NM-Germany Article no.				
			KBSFI40186DA	KBFI40186DA	KRFI40186DA						



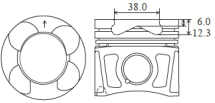

**DIESEL**



ENGINE TYPE Motortyp Type de Moteur Tipo de motor Тип двигателя	LINER KIT Liner Kit Kit de Chemise Camisas de los cilindros лайнер комплект	CYL. LINER Zylinderlaufbuchse Chemise Camisas de los cilindros втулка цилиндра	PISTON + RINGS Kolben + Ringe Piston + Segments Pistón Set Поршень и кольца			PISTON SET Kolben Set Set de Piston Pistón Set поршневой	RINGS SET Kolben Set Segments de Piston Anillos Set кольца	PIN Pin Axe Perno Пин
<b>199 A3</b> 4 Cyl 69.6 mm Bore Ø 1,248 cc		Length: 62.5 Outside Ø: 40.5 Flange Ø: -6.0 flange depth: -12.3	Length: 62.5 Comp: 40.5 Height: -6.0		alfin and with oil gallery skirt MOS2 treated fits tapered con. rod	Top: 2.0	Ø: 23.0 Length: 57.0	
						2nd: 1.5		
						3rd: 2.0 1st oil: 2nd oil:		
	Reference no.:	Reference no.:	Reference no.:	Reference no.:	O-RING			
			<b>K-40659600</b> <b>N-8742560000</b>		<b>A-R66830</b> <b>G-0813760000</b> <b>K-800056240000</b> <b>M-01004N0</b>			
NM-Germany Article no. Artikelnummer/ Modelo Número / статья НОМЕР	NM-Germany Article no.	NM-Germany Article no.	NM-Germany Article no.	NM-Germany Article no.	NM-Germany Article no.	NM-Germany Article no.		
			<b>KBSFI40187DB</b>	<b>KBFI40187DB</b>	<b>KRFI40187DB</b>			

FIAT

**GASOLINE**

ENGINE TYPE Motortyp Type de Moteur Tipo de motor Тип двигателя	LINER KIT Liner Kit Kit de Chemise Camisas de los cilindros лайнер комплект	CYL. LINER Zylinderlaufbuchse Chemise Camisas de los cilindros втулка цилиндра	PISTON + RINGS Kolben + Ringe Piston + Segments Pistón Set Поршень и кольца			PISTON SET Kolben Set Set de Piston Pistón Set поршневой	RINGS SET Kolben Set Segments de Piston Anillos Set кольца	PIN Pin Axe Perno Пин
<b>UNO 1.1</b> 4 Cyl 70.0 mm Bore Ø 1,108 cc		Length: 54.0 Outside Ø: 30.1 Flange Ø: -0.9 flange depth: -1.6	Length: 54.0 Comp: 30.1 Height: -0.9			Top: 1.5	Ø: 18.0 Length: 53.0	
						2nd: 1.5		
						3rd: 3.0 1st oil: 2nd oil:		
	Reference no.:	Reference no.:	Reference no.:	Reference no.:	O-RING			
					<b>5 882 324</b> <b>A-R46910</b> <b>G-0815420000</b> <b>M-00726N0</b>			
NM-Germany Article no. Artikelnummer/ Modelo Número / статья НОМЕР	NM-Germany Article no.	NM-Germany Article no.	NM-Germany Article no.	NM-Germany Article no.	NM-Germany Article no.	NM-Germany Article no.		
			<b>KBSFI40188G</b>	<b>KBFI40188G</b>	<b>KRFI40188G</b>			

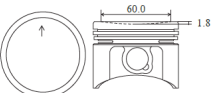
**GASOLINE**

ENGINE TYPE Motortyp Type de Moteur Tipo de motor Тип двигателя	LINER KIT Liner Kit Kit de Chemise Camisas de los cilindros лайнер комплект	CYL. LINER Zylinderlaufbuchse Chemise Camisas de los cilindros втулка цилиндра	PISTON + RINGS Kolben + Ringe Piston + Segments Pistón Set Поршень и кольца			PISTON SET Kolben Set Set de Piston Pistón Set поршневой	RINGS SET Kolben Set Segments de Piston Anillos Set кольца	PIN Pin Axe Perno Пин
<b>160 A3</b> <b>M 204 AA 11.0</b> 4 Cyl 70.0 mm Bore Ø 1,108 cc		Length: 116.0 Outside Ø: 72.98 Flange Ø: 1.8 flange depth:	Length: 54.0 Comp: 30.0 Height: -1.8			Top: 1.5	Ø: 18.0 Length: 53.0	
						2nd: 1.5		
						3rd: 3.0 1st oil: 2nd oil:		
	Reference no.:	Reference no.:	Reference no.:	Reference no.:	O-RING			
			<b>A-SU4320</b>	<b>A-24193</b> <b>A-24203</b> <b>K-922291600</b> <b>M-0089100</b> <b>N-8715420030</b>	<b>5 888 212</b> <b>5 888 213</b>	<b>5 882 324</b> <b>A-R46910</b> <b>G-0815420000</b> <b>M-00726N0</b>		
NM-Germany Article no. Artikelnummer/ Modelo Número / статья НОМЕР	NM-Germany Article no.	NM-Germany Article no.	NM-Germany Article no.	NM-Germany Article no.	NM-Germany Article no.	NM-Germany Article no.		
	<b>LBSFI40189GP</b>	<b>LBFI40189GP</b>	<b>KBSFI40189G</b>	<b>KBFI40189G</b>	<b>KRFI40189G</b>			

**GASOLINE**

ENGINE TYPE Motortyp Type de Moteur Tipo de motor Тип двигателя	LINER KIT Liner Kit Kit de Chemise Camisas de los cilindros лайнер комплект	CYL. LINER Zylinderlaufbuchse Chemise Camisas de los cilindros втулка цилиндра	PISTON + RINGS Kolben + Ringe Piston + Segments Pistón Set Поршень и кольца			PISTON SET Kolben Set Set de Piston Pistón Set поршневой	RINGS SET Kolben Set Segments de Piston Anillos Set кольца	PIN Pin Axe Perno Пин	
<b>156 C.046</b> <b>176 A6/B2</b> <b>M 204 AA 11.0</b> 4 Cyl 70.0 mm Bore Ø 1,108 cc		Length:	116.0	Length:	50.0	Top:	1.2	Ø: 18.0 Length: 53.0	
		Outside Ø:	72.98	Comp:	30.0	2nd:	1.2		
		Flange Ø:		Height:	-0.6	3rd:			1st oil:
		flange depth			-1.8	2nd oil:			
		Reference no.:		Reference no.:		Reference no.:		O-RING	
		<b>A-SU4320</b>		<b>A-24231</b> <b>K-94910600</b> <b>K-94910700</b> <b>M-0093600</b> <b>N-8714230000</b>		<b>5 892 880</b> <b>5 893 579</b>		<b>A-R48480</b> <b>G-0814230000</b> <b>K-800051340000</b> <b>M-00936N0</b>	
NM-Germany Article no. Artikelnummer/ Modelo Número / статья НОМЕР	NM-Germany Article no.	NM-Germany Article no.	NM-Germany Article no.	NM-Germany Article no.	NM-Germany Article no.	NM-Germany Article no.	NM-Germany Article no.	NM-Germany Article no.	
	<b>LBSFI40190GP</b>	<b>LBFI40190GP</b>	<b>KBSFI40190G</b>	<b>KBFI40190G</b>	<b>KRFI40190G</b>	<b>KRFI40190G</b>			

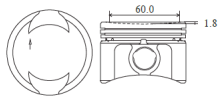
**GASOLINE**

ENGINE TYPE Motortyp Type de Moteur Tipo de motor Тип двигателя	LINER KIT Liner Kit Kit de Chemise Camisas de los cilindros лайнер комплект	CYL. LINER Zylinderlaufbuchse Chemise Camisas de los cilindros втулка цилиндра	PISTON + RINGS Kolben + Ringe Piston + Segments Pistón Set Поршень и кольца			PISTON SET Kolben Set Set de Piston Pistón Set поршневой	RINGS SET Kolben Set Segments de Piston Anillos Set кольца	PIN Pin Axe Perno Пин	
<b>1.0L FIRE 8V</b> 4 Cyl 70.0 mm Bore Ø 999 cc		Length:		Length:	53.05	Top:	1.2	Ø: 18.0 Length: 53.0	
		Outside Ø:		Comp:	33.05	2nd:	1.2		
		Flange Ø:		Height:	-1.0	3rd:			1st oil:
		flange depth				2nd oil:			
		Reference no.:		Reference no.:		Reference no.:		O-RING	
				<b>M-S25400</b>		<b>M-E25400</b>		<b>A-R48480</b> <b>G-0814230000</b> <b>K-800051340000</b> <b>M-00936N0</b>	
NM-Germany Article no. Artikelnummer/ Modelo Número / статья НОМЕР	NM-Germany Article no.	NM-Germany Article no.	NM-Germany Article no.	NM-Germany Article no.	NM-Germany Article no.	NM-Germany Article no.	NM-Germany Article no.	NM-Germany Article no.	
			<b>KBSFI40191G</b>	<b>KBFI40191G</b>	<b>KRFI40191G</b>	<b>KRFI40191G</b>			

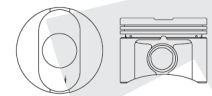

**GASOLINE**

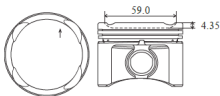
ENGINE TYPE Motortyp Type de Moteur Tipo de motor Тип двигателя	LINER KIT Liner Kit Kit de Chemise Camisas de los cilindros лайнер комплект	CYL. LINER Zylinderlaufbuchse Chemise Camisas de los cilindros втулка цилиндра	PISTON + RINGS Kolben + Ringe Piston + Segments Pistón Set Поршень и кольца			PISTON SET Kolben Set Set de Piston Pistón Set поршневой	RINGS SET Kolben Set Segments de Piston Anillos Set кольца	PIN Pin Axe Perno Пин	
<b>1.0L FIRE 16V</b> 4 Cyl 70.0 mm Bore Ø 999 cc		Length:		Length:	53.05	Top:	1.2	Ø: 18.0 Length: 53.0	
		Outside Ø:		Comp:	33.05	2nd:	1.2		
		Flange Ø:		Height:	-2.4	3rd:			1st oil:
		flange depth			-4.35	2nd oil:			
		Reference no.:		Reference no.:		Reference no.:		O-RING	
				<b>M-S25410</b>		<b>M-E25410</b>		<b>A-R48480</b> <b>G-0814230000</b> <b>K-800051340000</b> <b>M-00936N0</b>	
NM-Germany Article no. Artikelnummer/ Modelo Número / статья НОМЕР	NM-Germany Article no.	NM-Germany Article no.	NM-Germany Article no.	NM-Germany Article no.	NM-Germany Article no.	NM-Germany Article no.	NM-Germany Article no.	NM-Germany Article no.	
			<b>KBSFI40192G</b>	<b>KBFI40192G</b>	<b>KRFI40192G</b>	<b>KRFI40192G</b>			

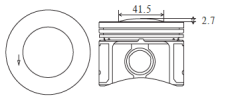

**GASOLINE**

ENGINE TYPE Motortyp Type de Moteur Tipo de motor Тип двигателя	LINER KIT Liner Kit Kit de Chemise Camisas de los cilindros лайнер комплект	CYL. LINER Zylinderlaufbuchse Chemise Camisas de los cilindros втулка цилиндра	PISTON + RINGS Kolben + Ringe Piston + Segments Pistón Set Поршень и кольца			PISTON SET Kolben Set Set de Piston Pistón Set поршневой	RINGS SET Kolben Set Segments de Piston Anillos Set кольца	PIN Pin Axe Perno Пин		
<b>1.0L FIRE 8V</b> 4 Cyl 70.0 mm Bore Ø 999 cc			Length:		Length:	55.85	skirt MOS2 treated	Top:	1.2	Ø: 18.0
			Outside Ø:		Comp:	33.05		2nd:	1.2	
			Flange Ø:		Height:	2.7	3rd:	2.5	Length: 53.0	
			flange depth				1st oil:			
							2nd oil:			
			<b>Reference no.:</b>	<b>Reference no.:</b>	<b>Reference no.:</b>	<b>Reference no.:</b>	<b>O-RING</b>			
				<b>M-S25890</b>	<b>M-E25890</b>		<b>A-R48480</b> <b>G-0814230000</b> <b>K-800051340000</b> <b>M-00936N0</b>			
NM-Germany Article no. Artikelnummer/ Modelo Número / статья НОМЕР	NM-Germany Article no.	NM-Germany Article no.	NM-Germany Article no.	NM-Germany Article no.	NM-Germany Article no.	NM-Germany Article no.	NM-Germany Article no.	NM-Germany Article no.		
			<b>KBSFI40193G</b>	<b>KBFI40193G</b>	<b>KRFI40193G</b>					



FIAT

**GASOLINE**

ENGINE TYPE Motortyp Type de Moteur Tipo de motor Тип двигателя	LINER KIT Liner Kit Kit de Chemise Camisas de los cilindros лайнер комплект	CYL. LINER Zylinderlaufbuchse Chemise Camisas de los cilindros втулка цилиндра	PISTON + RINGS Kolben + Ringe Piston + Segments Pistón Set Поршень и кольца			PISTON SET Kolben Set Set de Piston Pistón Set поршневой	RINGS SET Kolben Set Segments de Piston Anillos Set кольца	PIN Pin Axe Perno Пин		
<b>1.3L FIRE 8V FLEX</b> 4 Cyl 70.8 mm Bore Ø 1,242 cc			Length:		Length:	48.1	skirt MOS2 treated	Top:	1.2	Ø: 17.98
			Outside Ø:		Comp:	28.0		2nd:	1.2	
			Flange Ø:		Height:	-1.0	3rd:	2.5	Length: 49.0	
			flange depth				1st oil:			
							2nd oil:			
			<b>Reference no.:</b>	<b>Reference no.:</b>	<b>Reference no.:</b>	<b>Reference no.:</b>	<b>O-RING</b>			
				<b>M-S25456</b>	<b>M-E25456</b>		<b>A-R66670</b> <b>G-0813840000</b> <b>K-800051240000</b> <b>M-00941N0</b> <b>M-00970N0</b>			
NM-Germany Article no. Artikelnummer/ Modelo Número / статья НОМЕР	NM-Germany Article no.	NM-Germany Article no.	NM-Germany Article no.	NM-Germany Article no.	NM-Germany Article no.	NM-Germany Article no.	NM-Germany Article no.	NM-Germany Article no.		
			<b>KBSFI40194G</b>	<b>KBFI40194G</b>	<b>KRFI40194G</b>					

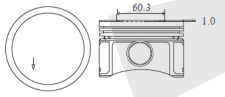



**GASOLINE**

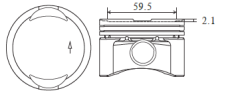

ENGINE TYPE Motortyp Type de Moteur Tipo de motor Тип двигателя	LINER KIT Liner Kit Kit de Chemise Camisas de los cilindros лайнер комплект	CYL. LINER Zylinderlaufbuchse Chemise Camisas de los cilindros втулка цилиндра	PISTON + RINGS Kolben + Ringe Piston + Segments Pistón Set Поршень и кольца			PISTON SET Kolben Set Set de Piston Pistón Set поршневой	RINGS SET Kolben Set Segments de Piston Anillos Set кольца	PIN Pin Axe Perno Пин		
<b>1.3L FIRE 8V</b> 4 Cyl 70.8 mm Bore Ø 1,242 cc			Length:		Length:	48.0	pin boss gap=22mm	Top:	1.2	Ø: 17.98
			Outside Ø:		Comp:	28.0		2nd:	1.2	
			Flange Ø:		Height:	-1.4	3rd:	2.5	Length: 49.0	
			flange depth			-2.1	1st oil:			
							2nd oil:			
			<b>Reference no.:</b>	<b>Reference no.:</b>	<b>Reference no.:</b>	<b>Reference no.:</b>	<b>O-RING</b>			
				<b>M-S25450</b>	<b>M-E25450</b>		<b>A-R66670</b> <b>G-0813840000</b> <b>K-800051240000</b> <b>M-00941N0</b> <b>M-00970N0</b>			
NM-Germany Article no. Artikelnummer/ Modelo Número / статья НОМЕР	NM-Germany Article no.	NM-Germany Article no.	NM-Germany Article no.	NM-Germany Article no.	NM-Germany Article no.	NM-Germany Article no.	NM-Germany Article no.	NM-Germany Article no.		
			<b>KBSFI40195G</b>	<b>KBFI40195G</b>	<b>KRFI40195G</b>					

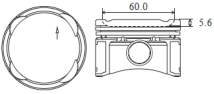

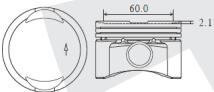

**GASOLINE**

ENGINE TYPE Motortyp Type de Moteur Tipo de motor Тип двигателя	LINER KIT Liner Kit Kit de Chemise Camisas de los cilindros лайнер комплект	CYL. LINER Zylinderlaufbuchse Chemise Camisas de los cilindros втулка цилиндра	PISTON + RINGS Kolben + Ringe Piston + Segments Pistón Set Поршень и кольца			PISTON SET Kolben Set Set de Piston Pistón Set поршневой	RINGS SET Kolben Set Segments de Piston Anillos Set кольца	PIN Pin Axe Perno Пин	
<b>1.3L FIRE 16V</b> 4 Cyl 70.8 mm Bore Ø 1,242 cc 		Length:		Length:	48.0	skirt MOS2 treated pin boss gap=20.6mm	Top:	1.2	Ø: 17.98 Length: 49.0
		Outside Ø:		Comp:	28.0		2nd:	1.2	
		Flange Ø:		Height:	-5.6		3rd:	2.5	
		flange depth					1st oil:	2.5	
			Reference no.:	Reference no.:	Reference no.:	Reference no.:	O-RING		
				<b>M-S25460</b>	<b>M-E25460</b>		<b>A-R66670</b> <b>G-0813840000</b> <b>K-800051240000</b> <b>M-00941N0</b> <b>M-00970N0</b>		
NM-Germany Article no. Artikelnummer/ Modelo Número / статья НОМЕР	NM-Germany Article no.	NM-Germany Article no.	NM-Germany Article no.	NM-Germany Article no.	NM-Germany Article no.	NM-Germany Article no.	NM-Germany Article no.		
			<b>KBSFI40196G</b>	<b>KBFI40196G</b>	<b>KRFI40196G</b>				

**GASOLINE**

ENGINE TYPE Motortyp Type de Moteur Tipo de motor Тип двигателя	LINER KIT Liner Kit Kit de Chemise Camisas de los cilindros лайнер комплект	CYL. LINER Zylinderlaufbuchse Chemise Camisas de los cilindros втулка цилиндра	PISTON + RINGS Kolben + Ringe Piston + Segments Pistón Set Поршень и кольца			PISTON SET Kolben Set Set de Piston Pistón Set поршневой	RINGS SET Kolben Set Segments de Piston Anillos Set кольца	PIN Pin Axe Perno Пин	
<b>176 A7/A8/ B4.000 178 B5.000</b> 4 Cyl 70.8 mm Bore Ø 1,242 cc 		Length:		Length:	48.0	pin boss gap=25mm	Top:	1.2	Ø: 17.98 Length: 53.0
		Outside Ø:		Comp:	28.0		2nd:	1.2	
		Flange Ø:		Height:	-1.4		3rd:	2.5	
		flange depth			-2.1		1st oil:	2.5	
			Reference no.:	Reference no.:	Reference no.:	Reference no.:	O-RING		
				<b>K-94870700</b> <b>M-0094100</b>			<b>A-R66670</b> <b>G-0813840000</b> <b>K-800051240000</b> <b>M-00941N0</b> <b>M-00970N0</b>		
NM-Germany Article no. Artikelnummer/ Modelo Número / статья НОМЕР	NM-Germany Article no.	NM-Germany Article no.	NM-Germany Article no.	NM-Germany Article no.	NM-Germany Article no.	NM-Germany Article no.	NM-Germany Article no.		
			<b>KBSFI40197G</b>	<b>KBFI40197G</b>	<b>KRFI40197G</b>				

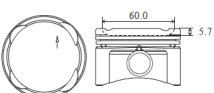
**GASOLINE**

ENGINE TYPE Motortyp Type de Moteur Tipo de motor Тип двигателя	LINER KIT Liner Kit Kit de Chemise Camisas de los cilindros лайнер комплект	CYL. LINER Zylinderlaufbuchse Chemise Camisas de los cilindros втулка цилиндра	PISTON + RINGS Kolben + Ringe Piston + Segments Pistón Set Поршень и кольца			PISTON SET Kolben Set Set de Piston Pistón Set поршневой	RINGS SET Kolben Set Segments de Piston Anillos Set кольца	PIN Pin Axe Perno Пин	
<b>176 B9.000 M 657 BA 12.T</b> 4 Cyl 70.8 mm Bore Ø 1,242 cc 		Length:		Length:	48.0	pin boss gap=25mm	Top:	1.2	Ø: 17.98 Length: 53.0
		Outside Ø:		Comp:	28.0		2nd:	1.2	
		Flange Ø:		Height:	-5.7		3rd:	2.5	
		flange depth					1st oil:	2.5	
			Reference no.:	Reference no.:	Reference no.:	Reference no.:	O-RING		
				<b>M-0095200</b>			<b>A-R66670</b> <b>G-0813840000</b> <b>K-800051240000</b> <b>M-00941N0</b> <b>M-00970N0</b>		
NM-Germany Article no. Artikelnummer/ Modelo Número / статья НОМЕР	NM-Germany Article no.	NM-Germany Article no.	NM-Germany Article no.	NM-Germany Article no.	NM-Germany Article no.	NM-Germany Article no.	NM-Germany Article no.		
			<b>KBSFI40198G</b>	<b>KBFI40198G</b>	<b>KRFI40198G</b>				

**GASOLINE**

ENGINE TYPE Motortyp Type de Moteur Tipo de motor Тип двигателя	LINER KIT Liner Kit Kit de Chemise Camisas de los cilindros лайнер комплект	CYL. LINER Zylinderlaufbuchse Chemise Camisas de los cilindros втулка цилиндра	PISTON + RINGS Kolben + Ringe Piston + Segments Pistón Set Поршень и кольца			PISTON SET Kolben Set Set de Piston Pistón Set поршневой	RINGS SET Kolben Set Segments de Piston Anillos Set кольца	PIN Pin Axe Perno Пин
<b>188 A5.000</b> <b>M 657 HA 12.T</b> 4 Cyl 70.8 mm Bore Ø 1,242 cc		Length: 48.0 Outside Ø: 28.0 Flange Ø: -5.1 flange depth	Length: 48.0 Comp: 28.0 Height: -5.1		pin boss gap=21.5mm	Top: 1.2	Ø: 17.98 Length: 49.0	
						2nd: 1.2		
						3rd: 1.2		
						1st oil: 2.5 2nd oil:		
			<b>Reference no.:</b>	<b>Reference no.:</b>	<b>Reference no.:</b>	<b>Reference no.:</b>	<b>O-RING</b>	
				<b>M-0097000</b>		<b>A-R66670</b> <b>G-0813840000</b> <b>K-800051240000</b> <b>M-00941N0</b> <b>M-00970N0</b>		
NM-Germany Article no. Artikelnummer/ Modelo Número / статья НОМЕР	NM-Germany Article no.	NM-Germany Article no.	NM-Germany Article no.	NM-Germany Article no.	NM-Germany Article no.	NM-Germany Article no.	NM-Germany Article no.	
			<b>KBSFI40199G</b>	<b>KBF140199G</b>	<b>KRF140199G</b>			

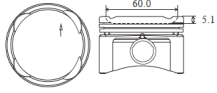

FIAT

**DIESEL**

ENGINE TYPE Motortyp Type de Moteur Tipo de motor Тип двигателя	LINER KIT Liner Kit Kit de Chemise Camisas de los cilindros лайнер комплект	CYL. LINER Zylinderlaufbuchse Chemise Camisas de los cilindros втулка цилиндра	PISTON + RINGS Kolben + Ringe Piston + Segments Pistón Set Поршень и кольца			PISTON SET Kolben Set Set de Piston Pistón Set поршневой	RINGS SET Kolben Set Segments de Piston Anillos Set кольца	PIN Pin Axe Perno Пин
<b>127 A5/M703 AA</b> 4 Cyl 76.0 mm Bore Ø 1,297 cc	<b>(A)</b> <b>M-0073270</b> <b>consists of (C)</b>  <b>(B)</b> <b>M-0073272</b> <b>Consists of (D)</b>	Length: 139.0 (C) 135.2 (D) Outside Ø: 79.0 79.1 Flange Ø: 82.0 flange depth 5.0	Length: 78.8 Comp: 46.8 Height: +4.95		alfin	Top: 2.5	Ø: 22.0 Length: 64.5	
						double keystone		
						2nd: 2.0		
						3rd: 3.0		
			<b>Reference no.:</b>	<b>Reference no.:</b>	<b>Reference no.:</b>	<b>Reference no.:</b>	<b>O-RING</b>	
			<b>M-007WV41 (C)</b> <b>M-007WV69 (D)</b>	<b>A-A350664</b> <b>K-90092600</b> <b>M-0073220</b>		<b>5 881 369</b> <b>A-R47020</b> <b>K-800005840000</b> <b>M-00732N0</b> <b>G-0821520010</b>		
NM-Germany Article no. Artikelnummer/ Modelo Número / статья НОМЕР	NM-Germany Article no.	NM-Germany Article no.	NM-Germany Article no.	NM-Germany Article no.	NM-Germany Article no.	NM-Germany Article no.	NM-Germany Article no.	
	<b>LBSFI40200DAP (A)</b> <b>LBSFI40200DAS (B)</b>	<b>LBF140200DAP (C)</b> <b>LBF140200DAS (D)</b>	<b>KBSFI40200DA</b>	<b>KBF140200DA</b>	<b>KRF140200DA</b>			



**GASOLINE**

ENGINE TYPE Motortyp Type de Moteur Tipo de motor Тип двигателя	LINER KIT Liner Kit Kit de Chemise Camisas de los cilindros лайнер комплект	CYL. LINER Zylinderlaufbuchse Chemise Camisas de los cilindros втулка цилиндра	PISTON + RINGS Kolben + Ringe Piston + Segments Pistón Set Поршень и кольца			PISTON SET Kolben Set Set de Piston Pistón Set поршневой	RINGS SET Kolben Set Segments de Piston Anillos Set кольца	PIN Pin Axe Perno Пин
<b>131 A</b> 4 Cyl 76.0 mm Bore Ø 1,297 cc		Length: 78.5 Outside Ø: 38.4 Flange Ø: 0.6 flange depth	Length: 78.5 Comp: 38.4 Height: 0.6			Top: 1.5	Ø: 22.0 Length: 61.0	
						2nd: 2.0		
						3rd: 3.95		
						1st oil: 3.95 2nd oil:		
			<b>Reference no.:</b>	<b>Reference no.:</b>	<b>Reference no.:</b>	<b>Reference no.:</b>	<b>O-RING</b>	
				<b>A-24172</b> <b>K-92916600</b> <b>M-0085600</b>	<b>5 880 236</b> <b>5 880 559</b> <b>5 880 560</b> <b>5 880 561</b> <b>5 881 047</b> <b>5 881 048</b> <b>5 881 049</b>	<b>0 588 0242</b> <b>0 588 0754</b> <b>0 588 2340</b> <b>5 880 977</b> <b>A-R47260</b> <b>G-0826970000</b> <b>K-800013741000</b> <b>M-00856N0</b> <b>T-50008</b>		
NM-Germany Article no. Artikelnummer/ Modelo Número / статья НОМЕР	NM-Germany Article no.	NM-Germany Article no.	NM-Germany Article no.	NM-Germany Article no.	NM-Germany Article no.	NM-Germany Article no.	NM-Germany Article no.	
			<b>KBSFI40201G</b>	<b>KBF140201G</b>	<b>KRF140201G</b>			

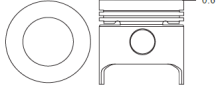

**GASOLINE**

ENGINE TYPE Motortyp Type de Moteur Tipo de motor Тип двигателя	LINER KIT Liner Kit Kit de Chemise Camisas de los cilindros лайнер комплект	CYL. LINER Zylinderlaufbuchse Chemise Camisas de los cilindros втулка цилиндра	PISTON + RINGS Kolben + Ringe Piston + Segments Pistón Set Поршень и кольца			PISTON SET Kolben Set Set de Piston Pistón Set поршневой	RINGS SET Kolben Set Segments de Piston Anillos Set кольца	PIN Pin Axe Perno Пин	
<b>1.0L FIASA</b> 4 Cyl 76.0 mm Bore Ø 994 cc		Length: Outside Ø: Flange Ø: flange depth	Length:	76.0	Comp: 37.0	Height: -2.2	Top:	1.5	Ø: 22.0 Length: 67.0
							2nd:	2.0	
							3rd:	4.0	
			Reference no.:	Reference no.:	Reference no.:	Reference no.:	O-RING		
				<b>M-S25100</b>	<b>M-E25100</b>	<b>M-A25110</b>			
NM-Germany Article no. Artikelnummer/ Modelo Número / статья НОМЕР	NM-Germany Article no.	NM-Germany Article no.	NM-Germany Article no.	NM-Germany Article no.	NM-Germany Article no.	NM-Germany Article no.	NM-Germany Article no.	NM-Germany Article no.	
			<b>KBSFI40202G</b>	<b>KBFI40202G</b>	<b>KRFI40202G</b>				

**GASOLINE**

ENGINE TYPE Motortyp Type de Moteur Tipo de motor Тип двигателя	LINER KIT Liner Kit Kit de Chemise Camisas de los cilindros лайнер комплект	CYL. LINER Zylinderlaufbuchse Chemise Camisas de los cilindros втулка цилиндра	PISTON + RINGS Kolben + Ringe Piston + Segments Pistón Set Поршень и кольца			PISTON SET Kolben Set Set de Piston Pistón Set поршневой	RINGS SET Kolben Set Segments de Piston Anillos Set кольца	PIN Pin Axe Perno Пин	
<b>1.5L FIASA</b> 4 Cyl 76.0 mm Bore Ø 1,497 cc		Length: Outside Ø: Flange Ø: flange depth	Length:	61.55	Comp: 35.55	Height: -6.4	Top:	1.5	Ø: 22.0 Length: 58.0
							2nd:	2.0	
							3rd:	4.0	
			Reference no.:	Reference no.:	Reference no.:	Reference no.:	O-RING		
				<b>M-S25020</b>	<b>M-E25020</b>	<b>M-A25110</b>			
NM-Germany Article no. Artikelnummer/ Modelo Número / статья НОМЕР	NM-Germany Article no.	NM-Germany Article no.	NM-Germany Article no.	NM-Germany Article no.	NM-Germany Article no.	NM-Germany Article no.	NM-Germany Article no.	NM-Germany Article no.	
			<b>KBSFI40203G</b>	<b>KBFI40203G</b>	<b>KRFI40203G</b>				

**GASOLINE**

ENGINE TYPE Motortyp Type de Moteur Tipo de motor Тип двигателя	LINER KIT Liner Kit Kit de Chemise Camisas de los cilindros лайнер комплект	CYL. LINER Zylinderlaufbuchse Chemise Camisas de los cilindros втулка цилиндра	PISTON + RINGS Kolben + Ringe Piston + Segments Pistón Set Поршень и кольца			PISTON SET Kolben Set Set de Piston Pistón Set поршневой	RINGS SET Kolben Set Segments de Piston Anillos Set кольца	PIN Pin Axe Perno Пин	
<b>1.0L FIASA MPI</b> 4 Cyl 76.0 mm Bore Ø 994 cc		Length: Outside Ø: Flange Ø: flange depth	Length:	77.7	Comp: 37.7	Height: -2.2	Top:	1.5	Ø: 22.0 Length: 67.0
							2nd:	1.5	
							3rd:	3.0	
			Reference no.:	Reference no.:	Reference no.:	Reference no.:	O-RING		
				<b>M-S25200</b>	<b>M-E25200</b>	<b>M-A25010</b>			
NM-Germany Article no. Artikelnummer/ Modelo Número / статья НОМЕР	NM-Germany Article no.	NM-Germany Article no.	NM-Germany Article no.	NM-Germany Article no.	NM-Germany Article no.	NM-Germany Article no.	NM-Germany Article no.	NM-Germany Article no.	
			<b>KBSFI40204G</b>	<b>KBFI40204G</b>	<b>KRFI40204G</b>				

**GASOLINE**

ENGINE TYPE Motortyp Type de Moteur Tipo de motor Тип двигателя	LINER KIT Liner Kit Kit de Chemise Camisas de los cilindros лайнер комплект	CYL. LINER Zylinderlaufbuchse Chemise Camisas de los cilindros втулка цилиндра	PISTON + RINGS Kolben + Ringe Piston + Segments Pistón Set Поршень и кольца			PISTON SET Kolben Set Set de Piston Pistón Set поршневой	RINGS SET Kolben Set Segments de Piston Anillos Set кольца	PIN Pin Axe Perno Пин
<b>1.5L FIASA MPI</b> 4 Cyl 76.0 mm Bore Ø 1,497 cc		Length: Outside Ø: Flange Ø: flange depth	Length: 61.6 Comp: 36.6 Height: -6.9			Top: 1.5	Ø: 22.0 Length: 55.0	
						2nd: 1.5		
						3rd: 1.5 1st oil: 3.0 2nd oil:		
	Reference no.:	Reference no.:	Reference no.:	Reference no.:	O-RING			
			<b>M-S25210</b>	<b>M-E25210</b>	<b>M-A25010</b>			
NM-Germany Article no. Artikelnummer/ Modelo Número / статья НОМЕР	NM-Germany Article no.	NM-Germany Article no.	NM-Germany Article no.	NM-Germany Article no.	NM-Germany Article no.	NM-Germany Article no.		
			<b>KBSFI40205G</b>	<b>KBFI40205G</b>	<b>KRFI40205G</b>			

FIAT



**GASOLINE**

ENGINE TYPE Motortyp Type de Moteur Tipo de motor Тип двигателя	LINER KIT Liner Kit Kit de Chemise Camisas de los cilindros лайнер комплект	CYL. LINER Zylinderlaufbuchse Chemise Camisas de los cilindros втулка цилиндра	PISTON + RINGS Kolben + Ringe Piston + Segments Pistón Set Поршень и кольца			PISTON SET Kolben Set Set de Piston Pistón Set поршневой	RINGS SET Kolben Set Segments de Piston Anillos Set кольца	PIN Pin Axe Perno Пин
<b>127</b> 4 Cyl 76.0 mm Bore Ø 1,049 cc		Length: Outside Ø: Flange Ø: flange depth	Length: 75.5 Comp: 35.5 Height: 0.5			Top: 1.5	Ø: 22.0 Length: 66.8	
						2nd: 2.0		
						3rd: 2.0 1st oil: 4.0 2nd oil:		
	Reference no.:	Reference no.:	Reference no.:	Reference no.:	O-RING			
			<b>M-S25110</b>	<b>M-E25110</b>	<b>M-A25110</b>			
NM-Germany Article no. Artikelnummer/ Modelo Número / статья НОМЕР	NM-Germany Article no.	NM-Germany Article no.	NM-Germany Article no.	NM-Germany Article no.	NM-Germany Article no.	NM-Germany Article no.		
			<b>KBSFI40206G</b>	<b>KBFI40206G</b>	<b>KRFI40206G</b>			

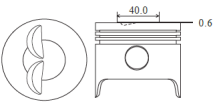

**GASOLINE**

ENGINE TYPE Motortyp Type de Moteur Tipo de motor Тип двигателя	LINER KIT Liner Kit Kit de Chemise Camisas de los cilindros лайнер комплект	CYL. LINER Zylinderlaufbuchse Chemise Camisas de los cilindros втулка цилиндра	PISTON + RINGS Kolben + Ringe Piston + Segments Pistón Set Поршень и кольца			PISTON SET Kolben Set Set de Piston Pistón Set поршневой	RINGS SET Kolben Set Segments de Piston Anillos Set кольца	PIN Pin Axe Perno Пин
<b>115 C</b> 4 Cyl 77.0 mm Bore Ø 1,481 cc	<b>M-0075290</b>	Length: 133.0 Outside Ø: 81.0 Flange Ø: flange depth	Length: 89.0 Comp: 36.5 Height: 9.5			Top: 2.0	Ø: 22.0 Length: 65.0	
						2nd: 2.0		
						3rd: 2.0 1st oil: 3.95 2nd oil:		
	Reference no.:	Reference no.:	Reference no.:	Reference no.:	O-RING			
	<b>M-007WV70</b>	<b>K-90395600</b> <b>M-0075200</b>	<b>5 880 165</b> <b>5 880 166</b> <b>5 880 167</b> <b>5 880 695</b> <b>5 880 696</b> <b>5 880 697</b>					
NM-Germany Article no. Artikelnummer/ Modelo Número / статья НОМЕР	NM-Germany Article no.	NM-Germany Article no.	NM-Germany Article no.	NM-Germany Article no.	NM-Germany Article no.	NM-Germany Article no.		
	<b>LBSFI40207GP</b>	<b>LBFI40207GP</b>	<b>KBSFI40207G</b>	<b>KBFI40207G</b>	<b>KRFI40207G</b>			

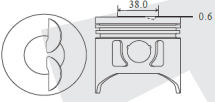

**GASOLINE**

ENGINE TYPE Motortyp Type de Moteur Tipo de motor Тип двигателя	LINER KIT Liner Kit Kit de Chemise Camisas de los cilindros лайнер комплект	CYL. LINER Zylinderlaufbuchse Chemise Camisas de los cilindros втулка цилиндра	PISTON + RINGS Kolben + Ringe Piston + Segments Pistón Set Поршень и кольца			PISTON SET Kolben Set Set de Piston Pistón Set поршневой	RINGS SET Kolben Set Segments de Piston Anillos Set кольца	PIN Pin Axe Perno Пин
<b>128</b> 4 Cyl 80.0 mm Bore Ø 1,116 cc 	<b>A-R47750</b> <b>G-0820310000</b> <b>K-800006141000</b> <b>M-00765N0</b> <b>G-1401892000</b>	Length: 114.0	Length: 74.5			Top: 1.5	Ø: 22.0 Length: 71.0	
		Outside Ø: 84.0	Comp: 34.5			2nd: 2.0		
		Flange Ø: flange depth	Height: 0.6			3rd: 3.95 1st oil: 2nd oil:		
		Reference no.:	Reference no.:	Reference no.:	Reference no.:	O-RING		
NM-Germany Article no. Artikelnummer/ Modelo Número / статья НОМЕР	NM-Germany Article no.	NM-Germany Article no.	NM-Germany Article no.	NM-Germany Article no.	NM-Germany Article no.	NM-Germany Article no.	NM-Germany Article no.	
	LBSFI40208GP	LBFI40208GP	KBSFI40208G	KBFI40208G	KRFI40208G			

**GASOLINE**

ENGINE TYPE Motortyp Type de Moteur Tipo de motor Тип двигателя	LINER KIT Liner Kit Kit de Chemise Camisas de los cilindros лайнер комплект	CYL. LINER Zylinderlaufbuchse Chemise Camisas de los cilindros втулка цилиндра	PISTON + RINGS Kolben + Ringe Piston + Segments Pistón Set Поршень и кольца			PISTON SET Kolben Set Set de Piston Pistón Set поршневой	RINGS SET Kolben Set Segments de Piston Anillos Set кольца	PIN Pin Axe Perno Пин
<b>128</b> 4 Cyl 80.0 mm Bore Ø 1,116 cc 	<b>A-R47750</b> <b>G-0820310000</b> <b>K-800006141000</b> <b>M-00765N0</b> <b>G-1401892000</b>	Length: 114.0	Length: 76.6			Top: 1.5	Ø: 22.0 Length: 71.0	
		Outside Ø: 84.0	Comp: 34.1			2nd: 2.0		
		Flange Ø: flange depth	Height: +0.6			3rd: 3.95 1st oil: 2nd oil:		
		Reference no.:	Reference no.:	Reference no.:	Reference no.:	O-RING		
NM-Germany Article no. Artikelnummer/ Modelo Número / статья НОМЕР	NM-Germany Article no.	NM-Germany Article no.	NM-Germany Article no.	NM-Germany Article no.	NM-Germany Article no.	NM-Germany Article no.	NM-Germany Article no.	
	LBSFI40209GP	LBFI40209GP	KBSFI40209G	KBFI40209G	KRFI40209G			

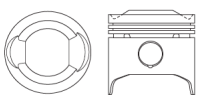
**GASOLINE**

ENGINE TYPE Motortyp Type de Moteur Tipo de motor Тип двигателя	LINER KIT Liner Kit Kit de Chemise Camisas de los cilindros лайнер комплект	CYL. LINER Zylinderlaufbuchse Chemise Camisas de los cilindros втулка цилиндра	PISTON + RINGS Kolben + Ringe Piston + Segments Pistón Set Поршень и кольца			PISTON SET Kolben Set Set de Piston Pistón Set поршневой	RINGS SET Kolben Set Segments de Piston Anillos Set кольца	PIN Pin Axe Perno Пин
<b>132 A</b> 4 Cyl 80.0 mm Bore Ø 1,592 cc 		Length:	Length: 81.8			Top: 1.5	Ø: 22.0 Length: 68.0	
		Outside Ø:	Comp: 37.7			2nd: 2.0		
		Flange Ø: flange depth	Height: 4.6			3rd: 3.95 1st oil: 2nd oil:		
		Reference no.:	Reference no.:	Reference no.:	Reference no.:	O-RING		
NM-Germany Article no. Artikelnummer/ Modelo Número / статья НОМЕР	NM-Germany Article no.	NM-Germany Article no.	NM-Germany Article no.	NM-Germany Article no.	NM-Germany Article no.	NM-Germany Article no.	NM-Germany Article no.	
			K-92472600 M-0075600	5 880 577 5 880 578 5 880 579	A-R47750 G-0820310000 K-800006141000 M-00765N0			
			KBSFI40210G	KBFI40210G	KRFI40210G			



**GASOLINE**

ENGINE TYPE Motortyp Type de Moteur Tipo de motor Тип двигателя	LINER KIT Liner Kit Kit de Chemise Camisas de los cilindros лайнер комплект	CYL. LINER Zylinderlaufbuchse Chemise Camisas de los cilindros втулка цилиндра	PISTON + RINGS Kolben + Ringe Piston + Segments Pistón Set Поршень и кольца			PISTON SET Kolben Set Set de Piston Pistón Set поршневой	RINGS SET Kolben Set Segments de Piston Anillos Set кольца	PIN Pin Axe Perno Пин				
<b>146 C/D</b> <b>160 A/ 836 A M202</b> <b>PA/M605 PB</b> 4 Cyl 80.5 mm Bore Ø 1,372 cc		Length: 72.8 Outside Ø: 33.3 Flange Ø: -2.4 flange depth	Length: 72.8	Comp: 33.3	Height: -2.4	Top: 1.5 2nd: 1.75 3rd: 1st oil: 3.0 2nd oil:	Ø: 22.0 Length: 58.0					
								Reference no.:	Reference no.:	Reference no.:	Reference no.:	O-RING
									<b>A-24204</b> <b>K-92292600</b> <b>M-0087600</b>		<b>A-R46940</b> <b>G-0878360000</b>	
NM-Germany Article no. Artikelnummer/ Modelo Número / статья НОМЕР	NM-Germany Article no.	NM-Germany Article no.	NM-Germany Article no.	NM-Germany Article no.	NM-Germany Article no.	NM-Germany Article no.	NM-Germany Article no.					
			KBSFI40211G	KBFI40211G	KRFI40211G							

FIAT



**DIESEL**

ENGINE TYPE Motortyp Type de Moteur Tipo de motor Тип двигателя	LINER KIT Liner Kit Kit de Chemise Camisas de los cilindros лайнер комплект	CYL. LINER Zylinderlaufbuchse Chemise Camisas de los cilindros втулка цилиндра	PISTON + RINGS Kolben + Ringe Piston + Segments Pistón Set Поршень и кольца			PISTON SET Kolben Set Set de Piston Pistón Set поршневой	RINGS SET Kolben Set Segments de Piston Anillos Set кольца	PIN Pin Axe Perno Пин			
<b>182 B4</b> <b>185 B4/M 722 BT.19</b> <b>185 A6/M 722 BT.24</b> 4/5 Cyl 82.0 mm Bore Ø 1,910 cc 2,387 cc		Length: 155.0 Outside Ø: 85.0 Flange Ø: 88.0 flange depth 4.5	Length: 73.25 Comp: 47.25 Height: -1.4 -17.5	alfin skirt MOS2 treated pin bushing inserted	Top: 3.0 double key- stone 2nd: 2.0 3rd: 1st oil: 3.0 2nd oil:	Ø: 25.99 Length: 61.0					
							Reference no.:	Reference no.:	Reference no.:	Reference no.:	O-RING
							<b>G-1402896000</b>	<b>A-A350534</b> <b>K-94966600</b> <b>M-0633700</b> <b>N-8710800000</b>		<b>A-R49870</b> <b>G-0810800000</b>	
NM-Germany Article no. Artikelnummer/ Modelo Número / статья НОМЕР	NM-Germany Article no.	NM-Germany Article no.	NM-Germany Article no.	NM-Germany Article no.	NM-Germany Article no.	NM-Germany Article no.	NM-Germany Article no.				
	LBSFI450212DSA	LBFI450212DSA	KBSFI450212DA	KBFI450212DA	KRFI450212DA						

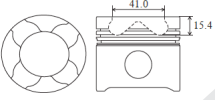

**DIESEL**

ENGINE TYPE Motortyp Type de Moteur Tipo de motor Тип двигателя	LINER KIT Liner Kit Kit de Chemise Camisas de los cilindros лайнер комплект	CYL. LINER Zylinderlaufbuchse Chemise Camisas de los cilindros втулка цилиндра	PISTON + RINGS Kolben + Ringe Piston + Segments Pistón Set Поршень и кольца			PISTON SET Kolben Set Set de Piston Pistón Set поршневой	RINGS SET Kolben Set Segments de Piston Anillos Set кольца	PIN Pin Axe Perno Пин			
<b>186 A8/192 A1</b> <b>937 A7/939 A1</b> 4 Cyl 82.0 mm Bore Ø 1,910 cc		Length: 155.0 Outside Ø: 85.0 Flange Ø: 88.0 flange depth 4.5	Length: 72.5 Comp: 46.5 Height: -6.0 -17.5	alfin skirt MOS2 treated pin bushing inserted	Top: 2.0 2nd: 2.0 3rd: 1st oil: 2.0 2nd oil:	Ø: 25.988 Length: 61.0					
							Reference no.:	Reference no.:	Reference no.:	Reference no.:	O-RING
							<b>G-1402896000</b>	<b>A-A354067</b> <b>K-40218600</b> <b>K-99724600</b> <b>M-0101500</b> <b>N-8712400030</b>	<b>0 623 552</b> <b>5 623 221/2</b> <b>5 518 1762/3/4</b> <b>5 518 1765/6/7</b> <b>7 171 8118/9</b> <b>7 173 4218/9</b>	<b>A-R60580</b> <b>A-R67925</b> <b>G-0812400000</b> <b>G-0814610000</b> <b>K-800072610000</b> <b>K-800073040000</b> <b>M-00981N0</b>	
NM-Germany Article no. Artikelnummer/ Modelo Número / статья НОМЕР	NM-Germany Article no.	NM-Germany Article no.	NM-Germany Article no.	NM-Germany Article no.	NM-Germany Article no.	NM-Germany Article no.	NM-Germany Article no.				
	LBSFI40213DSA	LBFI40213DSA	KBSFI40213DA	KBFI40213DA	KRFI40213DA						



**DIESEL**

ENGINE TYPE Motortyp Type de Moteur Tipo de motor Тип двигателя	LINER KIT Liner Kit Kit de Chemise Camisas de los cilindros лайнер комплект	CYL. LINER Zylinderlaufbuchse Chemise Camisas de los cilindros втулка цилиндра	PISTON + RINGS Kolben + Ringe Piston + Segments Pistón Set Поршень и кольца	PISTON SET Kolben Set Set de Piston Pistón Set поршень	RINGS SET Kolben Set Segments de Piston Anillos Set кольца	PIN Pin Axe Perno Пин
<b>192 B1/192 A5</b> <b>937 A4/937 A5</b> <b>841 G/841 M/841</b> <b>N M 729 AT.19/24</b> 4/5 Cyl 82.0 mm Bore Ø 1,910 cc 2,387 cc		Length: 155.0 Outside Ø: 85.0 Flange Ø: 88.0 flange depth 4.5	Length: 73.5 Comp: 46.5 Height: -0.7 -15.4	alfin and with oil gallery skirt MOS2 treated pin bushing inserted	Top: 2.0 2nd: 2.0 3rd: 2.0 1st oil: 2.0 2nd oil:	Ø: 26.0 Length: 61.0
		Reference no.:	Reference no.:	Reference no.:	Reference no.:	O-RING
		<b>G-1402896000</b>	<b>A-A354086</b> <b>K-40660600</b> <b>M-0101600</b> <b>N-8714610000</b>		<b>A-R60580</b> <b>A-R67925</b> <b>G-0812400000</b> <b>G-0814610000</b> <b>K-800072610000</b> <b>K-800073040000</b> <b>M-00981N0</b>	
NM-Germany Article no. Artikelnummer/ Modelo Número / статья НОМЕР	NM-Germany Article no.	NM-Germany Article no.	NM-Germany Article no.	NM-Germany Article no.	NM-Germany Article no.	NM-Germany Article no.
	<b>LBSFI450214DSB</b>	<b>LBFI450214DSB</b>	<b>KBSFI450214DB</b>	<b>KBFI450214DB</b>	<b>KRFI450214DB</b>	

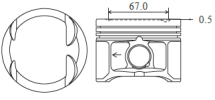

**DIESEL**

ENGINE TYPE Motortyp Type de Moteur Tipo de motor Тип двигателя	LINER KIT Liner Kit Kit de Chemise Camisas de los cilindros лайнер комплект	CYL. LINER Zylinderlaufbuchse Chemise Camisas de los cilindros втулка цилиндра	PISTON + RINGS Kolben + Ringe Piston + Segments Pistón Set Поршень и кольца	PISTON SET Kolben Set Set de Piston Pistón Set поршень	RINGS SET Kolben Set Segments de Piston Anillos Set кольца	PIN Pin Axe Perno Пин
<b>939 A3.000</b> 5 Cyl 82.0 mm Bore Ø 2,387 cc		Length: 155.0 Outside Ø: 85.0 Flange Ø: 88.0 flange depth 4.5	Length: 73.63 Comp: 46.63 Height: -15.6	alfin and with oil gallery fits tapered con. rod	Top: 2.0 2nd: 2.0 3rd: 2.0 1st oil: 2.0 2nd oil:	Ø: 30.0 Length: 67.0
		Reference no.:	Reference no.:	Reference no.:	Reference no.:	O-RING
		<b>G-1402896000</b>	<b>K-40036600</b>		<b>A-R60580</b> <b>A-R67925</b> <b>G-0812400000</b> <b>G-0814610000</b> <b>K-800072610000</b> <b>K-800073040000</b> <b>M-00981N0</b>	
NM-Germany Article no. Artikelnummer/ Modelo Número / статья НОМЕР	NM-Germany Article no.	NM-Germany Article no.	NM-Germany Article no.	NM-Germany Article no.	NM-Germany Article no.	NM-Germany Article no.
	<b>LBSFI50215DSB</b>	<b>LBFI50215DSB</b>	<b>KBSFI50215DB</b>	<b>KBFI50215DB</b>	<b>KRFI50215DB</b>	

**GASOLINE**

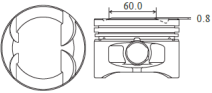

ENGINE TYPE Motortyp Type de Moteur Tipo de motor Тип двигателя	LINER KIT Liner Kit Kit de Chemise Camisas de los cilindros лайнер комплект	CYL. LINER Zylinderlaufbuchse Chemise Camisas de los cilindros втулка цилиндра	PISTON + RINGS Kolben + Ringe Piston + Segments Pistón Set Поршень и кольца	PISTON SET Kolben Set Set de Piston Pistón Set поршень	RINGS SET Kolben Set Segments de Piston Anillos Set кольца	PIN Pin Axe Perno Пин
<b>182 A2</b> <b>183 A1</b> <b>839 A4</b> 4 Cyl 82.0 mm Bore Ø 1,747 cc		Length: 60.2 Comp: 36.2 Height: -0.5	skirt MOS2 treated	Top: 1.2 2nd: 1.2 3rd: 2.0 1st oil: 2.0 2nd oil:	Ø: 20.0 Length: 52.0	
		Reference no.:	Reference no.:	Reference no.:	Reference no.:	O-RING
			<b>A-24126</b> <b>N-8711800000</b>		<b>A-R60000</b> <b>G-0811800000</b>	
NM-Germany Article no. Artikelnummer/ Modelo Número / статья НОМЕР	NM-Germany Article no.	NM-Germany Article no.	NM-Germany Article no.	NM-Germany Article no.	NM-Germany Article no.	NM-Germany Article no.
			<b>KBSFI40216G</b>	<b>KBFI40216G</b>	<b>KRFI40216G</b>	

**GASOLINE**

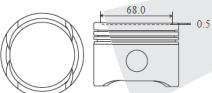

ENGINE TYPE Motortyp Type de Moteur Tipo de motor Тип двигателя	LINER KIT Liner Kit Kit de Chemise Camisas de los cilindros лайнер комплект	CYL. LINER Zylinderlaufbuchse Chemise Camisas de los cilindros втулка цилиндра	PISTON + RINGS Kolben + Ringe Piston + Segments Pistón Set Поршень и кольца		PISTON SET Kolben Set Set de Piston Pistón Set поршневой	RINGS SET Kolben Set Segments de Piston Anillos Set кольца	PIN Pin Axe Perno Пин	
<b>182 A1/B3/B7</b> <b>M 182 A</b> <b>M 648 AA</b> 5 Cyl 82.0 mm Bore Ø 1,998 cc 		Length: Outside Ø: Flange Ø: flange depth	Length:	57.7	skirt MOS2 treated	Top:	1.5	Ø: 20.0 Length: 52.0
			Comp:	32.9		2nd:	1.5	
			Height:	0.8		3rd:	3.0	
			Reference no.:	Reference no.:	Reference no.:	Reference no.:	O-RING	
				<b>A-24029</b> <b>M-0094400</b> <b>N-8778700000</b>	<b>5 894 839</b> <b>7 171 4638</b>	<b>M-00944N0</b> <b>M-06303N0</b>		
NM-Germany Article no. Artikelnummer/ Modelo Número / статья НОМЕР	NM-Germany Article no.	NM-Germany Article no.	NM-Germany Article no.	NM-Germany Article no.	NM-Germany Article no.	NM-Germany Article no.	NM-Germany Article no.	
			KBSFI50217G	KBFI50217G	KRFI50217G			

FIAT

**GASOLINE**

ENGINE TYPE Motortyp Type de Moteur Tipo de motor Тип двигателя	LINER KIT Liner Kit Kit de Chemise Camisas de los cilindros лайнер комплект	CYL. LINER Zylinderlaufbuchse Chemise Camisas de los cilindros втулка цилиндра	PISTON + RINGS Kolben + Ringe Piston + Segments Pistón Set Поршень и кольца		PISTON SET Kolben Set Set de Piston Pistón Set поршневой	RINGS SET Kolben Set Segments de Piston Anillos Set кольца	PIN Pin Axe Perno Пин	
<b>M 182 A</b> <b>M 646 AA.17</b> 4 Cyl 82.0 mm Bore Ø 1,747 cc 		Length: Outside Ø: Flange Ø: flange depth	Length:	60.15	skirt MOS2 treated	Top:	1.5	Ø: 20.0 Length: 52.0
			Comp:	36.15		2nd:	1.5	
			Height:	-0.5		3rd:	3.0	
			Reference no.:	Reference no.:	Reference no.:	Reference no.:	O-RING	
				<b>M-0630300</b>	<b>5 895 252</b>	<b>M-00944N0</b> <b>M-06303N0</b>		
NM-Germany Article no. Artikelnummer/ Modelo Número / статья НОМЕР	NM-Germany Article no.	NM-Germany Article no.	NM-Germany Article no.	NM-Germany Article no.	NM-Germany Article no.	NM-Germany Article no.	NM-Germany Article no.	
			KBSFI40218G	KBFI40218G	KRFI40218G			

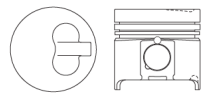
**DIESEL**

ENGINE TYPE Motortyp Type de Moteur Tipo de motor Тип двигателя	LINER KIT Liner Kit Kit de Chemise Camisas de los cilindros лайнер комплект	CYL. LINER Zylinderlaufbuchse Chemise Camisas de los cilindros втулка цилиндра	PISTON + RINGS Kolben + Ringe Piston + Segments Pistón Set Поршень и кольца		PISTON SET Kolben Set Set de Piston Pistón Set поршневой	RINGS SET Kolben Set Segments de Piston Anillos Set кольца	PIN Pin Axe Perno Пин			
<b>DW8 TD WJC/ WJY/WJZ</b> 4 Cyl 82.2 mm Bore Ø 1,868 cc 	K-99877960	Length: Outside Ø: Flange Ø: flange depth		STD		Top:	2.0	Ø: 25.0 Length: 66.0		
			Length:	77.7		O/S	77.45		2nd:	2.0
			Comp:	46.8		46.55	3rd:		3.0	
			Reference no.:	Reference no.:	Reference no.:	Reference no.:	O-RING			
			<b>K-89592190</b>	<b>A-350544</b> <b>K-99877600</b> <b>M-0400100</b> <b>N-8710400000</b>	<b>0628 J2</b>	<b>0640 PO A-R60230</b> <b>G-0810400000</b> <b>K-800045840000</b> <b>M-04001N0</b>				
NM-Germany Article no. Artikelnummer/ Modelo Número / статья НОМЕР	NM-Germany Article no.	NM-Germany Article no.	NM-Germany Article no.	NM-Germany Article no.	NM-Germany Article no.	NM-Germany Article no.	NM-Germany Article no.			
	LBSFI40219DP	LBFI40219DP	KBSFI40219D	KBFI40219D	KRFI40219D					

## DIESEL

ENGINE TYPE	LINER KIT	CYL. LINER	PISTON + RINGS		PISTON SET	RINGS SET	PIN		
Motor typ Type de Moteur Tipo de motor Тип двигателя	Liner Kit Kit de Chemise Camisas de los cilindros лайнер комплект	Zylinderlaufbuchse Chemise Camisas de los cilindros втулка цилиндра	Kolben + Ringe Piston + Segments Pistón Set Поршень и кольца		Kolben Set Set de Piston Pistón Set поршень	Kolben Set Segments de Piston Anillos Set кольца	Pin Axe Perno Пин		
<b>146 B2 / 149 B3</b> <b>M705 BA</b> <b>149 A1 / 160 A7</b> 4 Cyl 82.6 mm Bore Ø 1,698 cc 1,929 cc	<b>(A)</b> <b>M-0072890</b> consists of (C)  <b>(B)</b> <b>M-0072892</b> consists of (D)	Length:	154.0	154.2	Length:	84.1	alfin head anodized	Top: 2.5 double keystone 2nd: 2.0 3rd: 1st oil: 4.0 2nd oil:	Ø: 25.0  Length: 69.5
		Outside Ø:	86.0	86.1	Comp:	42.6			
		Flange Ø:		89.0	Height:	+2.3			
		flange depth		4.6					
		Reference no.:		Reference no.:	Reference no.:	Reference no.:	O-RING		
		<b>(C)</b> G-1401473000 K-89386190 M-007WV44		<b>A-A350668</b> M-0072800 N-8778230000	<b>5 889 143</b> 5 889 144 5 889 145 5 890 334	<b>A-R47120</b> G-0878230000 M-00728N0			
		<b>(D)</b> M-007WV66							
NM-Germany Article no. Artikelnummer/ Modelo Número / статья НОМЕР	NM-Germany Article no.	NM-Germany Article no.	NM-Germany Article no.	NM-Germany Article no.	NM-Germany Article no.	NM-Germany Article no.	NM-Germany Article no.		
	LBCS40220DAP (A) LBCS40220DAS (B)	LBCS40220DAP (C) LBCS40220DAS (D)	KBSCS40220DA	KBCS40220DA	KRCS40220DA				



## DIESEL

ENGINE TYPE	LINER KIT	CYL. LINER	PISTON + RINGS		PISTON SET	RINGS SET	PIN		
Motor typ Type de Moteur Tipo de motor Тип двигателя	Liner Kit Kit de Chemise Camisas de los cilindros лайнер комплект	Zylinderlaufbuchse Chemise Camisas de los cilindros втулка цилиндра	Kolben + Ringe Piston + Segments Pistón Set Поршень и кольца		Kolben Set Set de Piston Pistón Set поршень	Kolben Set Segments de Piston Anillos Set кольца	Pin Axe Perno Пин		
<b>M 721</b> <b>M 721 FA</b> 4 Cyl 82.6 mm Bore Ø 1,698 cc 1,929 cc	<b>M-0094790</b>	Length:	154.0		Length:	78.2	alfin skirt MOS2 treated	Top: 2.5 double key- stone 2nd: 2.0 3rd: 1st oil: 3.0 2nd oil:	Ø: 25.0  Length: 69.4
		Outside Ø:	86.0		Comp:	42.9			
		Flange Ø:			Height:	2.19			
		flange depth							
		Reference no.:		Reference no.:	Reference no.:	Reference no.:	O-RING		
		<b>G-1401473000</b> K-89386190 M-007WV44		<b>M-0094700</b>	<b>5 896 559</b>	<b>A-R47130</b> G-0878540000 K-800036641000 K-800036642000 M-00913N0 M-00913V0			
NM-Germany Article no. Artikelnummer/ Modelo Número / статья НОМЕР	NM-Germany Article no.	NM-Germany Article no.	NM-Germany Article no.	NM-Germany Article no.	NM-Germany Article no.	NM-Germany Article no.	NM-Germany Article no.		
	LBSFI40221DPA	LBSFI40221DPA	KBSFI40221DA	KBFI40221DA	KRFI40221DA				

## DIESEL



ENGINE TYPE	LINER KIT	CYL. LINER	PISTON + RINGS		PISTON SET	RINGS SET	PIN	
Motor typ Type de Moteur Tipo de motor Тип двигателя	Liner Kit Kit de Chemise Camisas de los cilindros лайнер комплект	Zylinderlaufbuchse Chemise Camisas de los cilindros втулка цилиндра	Kolben + Ringe Piston + Segments Pistón Set Поршень и кольца		Kolben Set Set de Piston Pistón Set поршень	Kolben Set Segments de Piston Anillos Set кольца	Pin Axe Perno Пин	
<b>D9B</b> <b>DJY</b> <b>XUD 9A</b> 4 Cyl 83.0 mm Bore Ø 1,905 cc	<b>(A)</b> <b>K-93648970</b> <b>M-0392490</b> consists of (C)  <b>(B)</b> <b>M-0392491</b> consists of (D)	Length:	153.5	153.5	Length:	84.3	Top: 2.0 2nd: 2.0 3rd: 1st oil: 3.0 2nd oil:	Ø: 25.0  Length: 72.0
		Outside Ø:	86.0	86.0	Comp:	46.8		
		Flange Ø:		89.0	Height:	-2.2		
		flange depth		4.8				
		Reference no.:		Reference no.:	Reference no.:	Reference no.:	O-RING	
		<b>(C)</b> K-89184190 M-039WV21		<b>A-350709</b> K-93648700 M-0392400 N-8715200010		<b>A-R66390</b> G-0815200000 K-800003740000 M-03924N0		
		<b>(D)</b> M-039WV32						
NM-Germany Article no. Artikelnummer/ Modelo Número / статья НОМЕР	NM-Germany Article no.	NM-Germany Article no.	NM-Germany Article no.	NM-Germany Article no.	NM-Germany Article no.	NM-Germany Article no.	NM-Germany Article no.	
	LBSFI40222DP (A) LBSFI40222DS (B)	LBSFI40222DP (C) LBSFI40222DS (D)	KBSFI40222D	KBFI40222D	KRFI40222D			

**DIESEL**

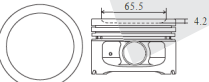

ENGINE TYPE Motortyp Type de Moteur Tipo de motor Тип двигателя	LINER KIT Liner Kit Kit de Chemise Camisas de los cilindros лайнер комплект	CYL. LINER Zylinderlaufbuchse Chemise Camisas de los cilindros втулка цилиндра	PISTON + RINGS Kolben + Ringe Piston + Segments Pistón Set Поршень и кольца		PISTON SET Kolben Set Set de Piston Pistón Set поршневой	RINGS SET Kolben Set Segments de Piston Anillos Set кольца	PIN Pin Axe Perno Пин	
<b>D8B/DHX TURBO XUD 9BTF TURBO XUD 9TF TURBO</b>		Length: Outside Ø: Flange Ø: flange depth	Length:	STD	O/S	alfin head anodized skirt MOS2 treated fits tapered con. rod	Top: 3.0 double keystone 2nd: 2.0 3rd: 1st oil: 3.0 2nd oil:	Ø: 28.0 Length: 68.0
			Length:	79.3	79.3			
			Comp:	46.8	46.65			
4 Cyl 83.0 mm Bore Ø 1,905 cc			Height:	-3.5	-3.5			
			Reference no.:	Reference no.:	Reference no.:	Reference no.:	O-RING	
				<b>A-A350520 K-94786700 M-0399600 N-8710550000</b>		<b>A-R60140 G-0810550000 M-03996N0</b>		
NM-Germany Article no. Artikelnummer/ Modelo Número / статья НОМЕР	NM-Germany Article no.	NM-Germany Article no.	NM-Germany Article no.	NM-Germany Article no.	NM-Germany Article no.	NM-Germany Article no.	NM-Germany Article no.	
			<b>KBSFI40223DA</b>	<b>KBFI40223DA</b>	<b>KRFI40223DA</b>			

FIAT

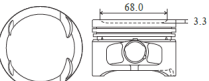

**GASOLINE**

ENGINE TYPE Motortyp Type de Moteur Tipo de motor Тип двигателя	LINER KIT Liner Kit Kit de Chemise Camisas de los cilindros лайнер комплект	CYL. LINER Zylinderlaufbuchse Chemise Camisas de los cilindros втулка цилиндра	PISTON + RINGS Kolben + Ringe Piston + Segments Pistón Set Поршень и кольца		PISTON SET Kolben Set Set de Piston Pistón Set поршневой	RINGS SET Kolben Set Segments de Piston Anillos Set кольца	PIN Pin Axe Perno Пин	
<b>LFW XU 7 JP</b>	<b>A-SA2423 K-94351960 K-94351970 M-0398792</b>	Length: 141.0 Outside Ø: 88.6 Flange Ø: 97.0 collar depth 95.19	Length:	53.4		Top: 1.5 2nd: 1.5 3rd: 1st oil: 3.0 2nd oil:	Ø: 22.0 Length: 62.0	
			Comp:	33.4				
			Height:	-4.2				
4 Cyl 83.0 mm Bore Ø 1,761 cc 1,762 cc			Reference no.:	Reference no.:	Reference no.:	Reference no.:	O-RING	
				<b>A-SJ4327 G-1463491000 K-89301110 M-039WN24</b>	<b>A-24142 K-94351600 K-94351700 M-0398700</b>	<b>A-R60190 G-0832340000 K-800003441000 M-03982V0 T-50014</b>	<b>ORFI40224G</b>	
NM-Germany Article no. Artikelnummer/ Modelo Número / статья НОМЕР	NM-Germany Article no.	NM-Germany Article no.	NM-Germany Article no.	NM-Germany Article no.	NM-Germany Article no.	NM-Germany Article no.	NM-Germany Article no.	
	<b>LBSFI40224GF</b>	<b>LBFI40224GF</b>	<b>KBSFI40224G</b>	<b>KBFI40224G</b>	<b>KRFI40224G</b>			

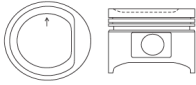

**GASOLINE**

ENGINE TYPE Motortyp Type de Moteur Tipo de motor Тип двигателя	LINER KIT Liner Kit Kit de Chemise Camisas de los cilindros лайнер комплект	CYL. LINER Zylinderlaufbuchse Chemise Camisas de los cilindros втулка цилиндра	PISTON + RINGS Kolben + Ringe Piston + Segments Pistón Set Поршень и кольца		PISTON SET Kolben Set Set de Piston Pistón Set поршневой	RINGS SET Kolben Set Segments de Piston Anillos Set кольца	PIN Pin Axe Perno Пин	
<b>192 A2</b>		Length: Outside Ø: Flange Ø: flange depth	Length:	56.4		skirt MOS2 treated	Top: 1.2 2nd: 1.5 3rd: 1st oil: 3.0 2nd oil:	Ø: 20.0 Length: 52.0
			Comp:	32.4				
			Height:	-3.3				
5 Cyl 83.0 mm Bore Ø 2,446 cc			Reference no.:	Reference no.:	Reference no.:	Reference no.:	O-RING	
				<b>M-S25330</b>	<b>7 172 7139 M-E25330 M-P9213</b>	<b>5 894 858 M-A25200 T-50040</b>		
NM-Germany Article no. Artikelnummer/ Modelo Número / статья НОМЕР	NM-Germany Article no.	NM-Germany Article no.	NM-Germany Article no.	NM-Germany Article no.	NM-Germany Article no.	NM-Germany Article no.	NM-Germany Article no.	
			<b>KBSFI50225G</b>	<b>KBFI50225G</b>	<b>KRFI50225G</b>			



**GASOLINE**

ENGINE TYPE Motortyp Type de Moteur Tipo de motor Тип двигателя	LINER KIT Liner Kit Kit de Chemise Camisas de los cilindros лайнер комплект	CYL. LINER Zylinderlaufbuchse Chemise Camisas de los cilindros втулка цилиндра	PISTON + RINGS Kolben + Ringe Piston + Segments Pistón Set Поршень и кольца			PISTON SET Kolben Set Set de Piston Pistón Set поршневой	RINGS SET Kolben Set Segments de Piston Anillos Set кольца	PIN Pin Axe Perno Пин
<b>171 B</b> 4 Cyl 83.0 mm Bore Ø 1,580 cc 	<b>A-SA2518</b> <b>K-93846980</b> <b>M-0397692</b> <b>N-8915120000</b>	Length: 141.0 Outside Ø: 88.6 Flange Ø: 97.0 collar depth 95.19	Length: 67.5 Comp: 37.5 Height: -2.1			Top: 1.75 2nd: 1.75 3rd: 1st oil: 4.0 2nd oil:	Ø: 22.0 Length: 66.0	
		Reference no.:	Reference no.:	Reference no.:	Reference no.:	O-RING		
		<b>A-SJ4327</b> <b>G-1463491000</b> <b>K-89301110</b> <b>M-039WN24</b>	<b>K-93846800</b> <b>M-0397600</b>	<b>A-R60940</b> <b>G-0815120000</b> <b>K-800003640000</b> <b>M-03976N0</b>	<b>ORFI40226G</b>			
NM-Germany Article no. Artikelnummer/ Modelo Número / статья НОМЕР	NM-Germany Article no.	NM-Germany Article no.	NM-Germany Article no.	NM-Germany Article no.	NM-Germany Article no.	NM-Germany Article no.	NM-Germany Article no.	
	LBSFI40226GF	LBF40226GF	KBSFI40226G	KBFI40226G	KRFI40226G			

**GASOLINE**

ENGINE TYPE Motortyp Type de Moteur Tipo de motor Тип двигателя	LINER KIT Liner Kit Kit de Chemise Camisas de los cilindros лайнер комплект	CYL. LINER Zylinderlaufbuchse Chemise Camisas de los cilindros втулка цилиндра	PISTON + RINGS Kolben + Ringe Piston + Segments Pistón Set Поршень и кольца			PISTON SET Kolben Set Set de Piston Pistón Set поршневой	RINGS SET Kolben Set Segments de Piston Anillos Set кольца	PIN Pin Axe Perno Пин
<b>169 B</b> <b>XM 7 T</b> 4 Cyl 84.0 mm Bore Ø 1,796 cc 	<b>A-SA2549</b> <b>N-8931530000</b>	Length: 136.2 Outside Ø: 93.0 Flange Ø: 99.2 collar depth 90.0	Length: 71.2 Comp: 38.0 Height: +0			Top: 1.5 2nd: 2.0 3rd: 1st oil: 4.0 2nd oil:	Ø: 23.0 Length: 70.0	
		Reference no.:	Reference no.:	Reference no.:	Reference no.:	O-RING		
		<b>G-1460667000</b>			<b>A-R66060</b> <b>G-0831530000</b> <b>K-800006640000</b> <b>M-03932N0</b>	<b>ORFI40227G</b>		
NM-Germany Article no. Artikelnummer/ Modelo Número / статья НОМЕР	NM-Germany Article no.	NM-Germany Article no.	NM-Germany Article no.	NM-Germany Article no.	NM-Germany Article no.	NM-Germany Article no.	NM-Germany Article no.	
	LBSFI40227GF	LBF40227GF	KBSFI40227G	KBFI40227G	KRFI40227G			

**GASOLINE**

ENGINE TYPE Motortyp Type de Moteur Tipo de motor Тип двигателя	LINER KIT Liner Kit Kit de Chemise Camisas de los cilindros лайнер комплект	CYL. LINER Zylinderlaufbuchse Chemise Camisas de los cilindros втулка цилиндра	PISTON + RINGS Kolben + Ringe Piston + Segments Pistón Set Поршень и кольца			PISTON SET Kolben Set Set de Piston Pistón Set поршневой	RINGS SET Kolben Set Segments de Piston Anillos Set кольца	PIN Pin Axe Perno Пин
<b>131 A</b> 4 Cyl 84.0 mm Bore Ø 1,585 cc 		Length: Outside Ø: Flange Ø: flange depth	Length: 77.9 Comp: 38.5 Height: 0			Top: 1.5 2nd: 2.0 3rd: 1st oil: 3.95 2nd oil:	Ø: 22.0 Length: 69.0	
		Reference no.:	Reference no.:	Reference no.:	Reference no.:	O-RING		
			<b>A-24194</b> <b>K-92915600</b> <b>M-0086500</b>	<b>5 880 249-251</b> <b>5 880 565-567</b> <b>5 880 622-624</b> <b>5 880 731-733</b>	<b>5 881 629</b> <b>A-R46970</b> <b>G-0821530010</b> <b>K-800006541000</b> <b>M-00865N0</b>			
NM-Germany Article no. Artikelnummer/ Modelo Número / статья НОМЕР	NM-Germany Article no.	NM-Germany Article no.	NM-Germany Article no.	NM-Germany Article no.	NM-Germany Article no.	NM-Germany Article no.	NM-Germany Article no.	
			KBSFI40228G	KBFI40228G	KRFI40228G			

**GASOLINE**

ENGINE TYPE Motortyp Type de Moteur Tipo de motor Тип двигателя	LINER KIT Liner Kit Kit de Chemise Camisas de los cilindros лайнер комплект	CYL. LINER Zylinderlaufbuchse Chemise Camisas de los cilindros втулка цилиндра	PISTON + RINGS Kolben + Ringe Piston + Segments Pistón Set Поршень и кольца	PISTON SET Kolben Set Set de Piston Pistón Set поршневой	RINGS SET Kolben Set Segments de Piston Anillos Set кольца	PIN Pin Axe Perno Пин
<b>124 B3</b> <b>131 B2</b> <b>132 C2/C3/D1</b> 4 Cyl 84.0 mm Bore Ø 1,585 cc 1,995 cc		Length:	Length:		Top:	Ø: 22.0 Length: 69.0
		Outside Ø:	Comp:		2nd:	
		Flange Ø:	Height:		3rd:	
		flange depth	-5.1		1st oil: 3.95	2nd oil:
		Reference no.:	Reference no.:	Reference no.:	Reference no.:	O-RING
			K-93279600 M-0086600	5 880 748 5 880 749 5 880 750	5 881 629 A-R46970 G-0821530010 K-800006541000 M-00865N0	
NM-Germany Article no. Artikelnummer/ Modelo Número / статья НОМЕР	NM-Germany Article no.	NM-Germany Article no.	NM-Germany Article no.	NM-Germany Article no.	NM-Germany Article no.	NM-Germany Article no.
			KBSFI40229G	KBFI40229G	KRFI40229G	

FIAT

**GASOLINE**

ENGINE TYPE Motortyp Type de Moteur Tipo de motor Тип двигателя	LINER KIT Liner Kit Kit de Chemise Camisas de los cilindros лайнер комплект	CYL. LINER Zylinderlaufbuchse Chemise Camisas de los cilindros втулка цилиндра	PISTON + RINGS Kolben + Ringe Piston + Segments Pistón Set Поршень и кольца	PISTON SET Kolben Set Set de Piston Pistón Set поршневой	RINGS SET Kolben Set Segments de Piston Anillos Set кольца	PIN Pin Axe Perno Пин
<b>131 A/B/C</b> <b>132 AB/BB/CB</b> 4 Cyl 84.0 mm Bore Ø 1,756 cc		Length:	Length:		Top:	Ø: 22.0 Length: 69.0
		Outside Ø:	Comp:		2nd:	
		Flange Ø:	Height:		3rd:	
		flange depth	2.0		1st oil: 3.95	2nd oil:
		Reference no.:	Reference no.:	Reference no.:	Reference no.:	O-RING
			K-92425600 M-0077500	5 880 221 5 880 222 5 880 223 5 880 607 5 880 608 5 880 609	5 881 629 A-R46970 G-0821530010 K-800006541000 M-00865N0	
NM-Germany Article no. Artikelnummer/ Modelo Número / статья НОМЕР	NM-Germany Article no.	NM-Germany Article no.	NM-Germany Article no.	NM-Germany Article no.	NM-Germany Article no.	NM-Germany Article no.
			KBSFI40230G	KBFI40230G	KRFI40230G	

**GASOLINE**

ENGINE TYPE Motortyp Type de Moteur Tipo de motor Тип двигателя	LINER KIT Liner Kit Kit de Chemise Camisas de los cilindros лайнер комплект	CYL. LINER Zylinderlaufbuchse Chemise Camisas de los cilindros втулка цилиндра	PISTON + RINGS Kolben + Ringe Piston + Segments Pistón Set Поршень и кольца	PISTON SET Kolben Set Set de Piston Pistón Set поршневой	RINGS SET Kolben Set Segments de Piston Anillos Set кольца	PIN Pin Axe Perno Пин
<b>132 AZ</b> 4 Cyl 84.0 mm Bore Ø 1,750 cc	5 881 629 A-R46970 G-0821530010 K-800006541000 M-00865N0	Length:	Length:		Top:	Ø: 22.0 Length: 69.0
		Outside Ø:	Comp:		2nd:	
		Flange Ø:	Height:		3rd:	
		flange depth	-9.7		1st oil: 3.95	2nd oil:
		Reference no.:	Reference no.:	Reference no.:	Reference no.:	O-RING
NM-Germany Article no. Artikelnummer/ Modelo Número / статья НОМЕР	NM-Germany Article no.	NM-Germany Article no.	NM-Germany Article no.	NM-Germany Article no.	NM-Germany Article no.	NM-Germany Article no.
			KBSFI40231G	KBFI40231G	KRFI40231G	

**DIESEL**

ENGINE TYPE Motortyp Type de Moteur Tipo de motor Тип двигателя	LINER KIT Liner Kit Kit de Chemise Camisas de los cilindros лайнер комплект	CYL. LINER Zylinderlaufbuchse Chemise Camisas de los cilindros втулка цилиндра	PISTON + RINGS Kolben + Ringe Piston + Segments Pistón Set Поршень и кольца		PISTON SET Kolben Set Set de Piston Pistón Set поршневой	RINGS SET Kolben Set Segments de Piston Anillos Set кольца	PIN Pin Axe Perno Пин				
<b>DW10 ATED RHZ</b> 4 Cyl 85.0 mm Bore Ø 1,997 cc		Length: 155.0 Outside Ø: 89.06 Flange Ø: 91.0 flange depth 4.5	Length: 80.7 Comp: 46.7 Height: -6.0 -18.3		alfin skirt MOS2 treated fits tapered con. rod	Top: 3.5 double key-stone	Ø: 28.0 Length: 70.0				
						2nd: 2.0 3rd: 3.0 1st oil: 3.0 2nd oil:					
<b>Reference no.:</b>		<b>Reference no.:</b>		<b>Reference no.:</b>		<b>Reference no.:</b>		<b>O-RING</b>			
		A-A350566 K-99879601 M-0399900 N-8711470000				A-R60410 G-0811470000 K-800045940000 M-03999N0					
NM-Germany Article no. Artikelnummer/ Modelo Número / статья НОМЕР		NM-Germany Article no.		NM-Germany Article no.		NM-Germany Article no.		NM-Germany Article no.			
		LBSFI40232DSA		LBFI40232DSA		KBSFI40232DA		KBF140232DA		KRF140232DA	

**DIESEL**



ENGINE TYPE Motortyp Type de Moteur Tipo de motor Тип двигателя	LINER KIT Liner Kit Kit de Chemise Camisas de los cilindros лайнер комплект	CYL. LINER Zylinderlaufbuchse Chemise Camisas de los cilindros втулка цилиндра	PISTON + RINGS Kolben + Ringe Piston + Segments Pistón Set Поршень и кольца		PISTON SET Kolben Set Set de Piston Pistón Set поршневой	RINGS SET Kolben Set Segments de Piston Anillos Set кольца	PIN Pin Axe Perno Пин				
<b>DW10 BTED4</b> 4 Cyl 85.0 mm Bore Ø 1,997 cc	K-99700600 A-R60410 G-0811470000 K-800045940000 M-03999N0	Length: 165.0 Outside Ø: 89.06 Flange Ø: 91.0 flange depth 4.5	Length: 80.7 Comp: 46.7 Height: -4.7 -15.4		alfin and with oil gallery skirt MOS2 treated fits tapered con. rod	Top: 3.5 double key-stone	Ø: 28.0 Length: 70.0				
						2nd: 2.0 3rd: 3.0 1st oil: 3.0 2nd oil:					
<b>Reference no.:</b>		<b>Reference no.:</b>		<b>Reference no.:</b>		<b>Reference no.:</b>		<b>O-RING</b>			
NM-Germany Article no. Artikelnummer/ Modelo Número / статья НОМЕР		NM-Germany Article no.		NM-Germany Article no.		NM-Germany Article no.		NM-Germany Article no.			
		LBSFI40233DSB		LBFI40233DSB		KBSFI40233DB		KBF140233DB		KRF140233DB	

**DIESEL**

ENGINE TYPE Motortyp Type de Moteur Tipo de motor Тип двигателя	LINER KIT Liner Kit Kit de Chemise Camisas de los cilindros лайнер комплект	CYL. LINER Zylinderlaufbuchse Chemise Camisas de los cilindros втулка цилиндра	PISTON + RINGS Kolben + Ringe Piston + Segments Pistón Set Поршень и кольца		PISTON SET Kolben Set Set de Piston Pistón Set поршневой	RINGS SET Kolben Set Segments de Piston Anillos Set кольца	PIN Pin Axe Perno Пин				
<b>4HW</b> 4 Cyl 85.0 mm Bore Ø 2,179 cc	K-40406600 A-R60410 G-0811470000 K-800045940000 M-03999N0	Length: 165.0 Outside Ø: 89.06 Flange Ø: 91.0 flange depth 4.5	Length: 77.7 Comp: 48.7 Height: -9.8 -18.0		alfin and with oil gallery skirt MOS2 treated	Top: 3.5 double key-stone	Ø: 30.0 Length: 68.0				
						2nd: 2.0 3rd: 3.0 1st oil: 3.0 2nd oil:					
<b>Reference no.:</b>		<b>Reference no.:</b>		<b>Reference no.:</b>		<b>Reference no.:</b>		<b>O-RING</b>			
NM-Germany Article no. Artikelnummer/ Modelo Número / статья НОМЕР		NM-Germany Article no.		NM-Germany Article no.		NM-Germany Article no.		NM-Germany Article no.			
		LBSFI40234DSB		LBFI40234DSB		KBSFI40234DB		KBF140234DB		KRF140234DB	



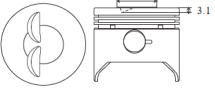

**GASOLINE**



ENGINE TYPE Motortyp Type de Moteur Tipo de motor Тип двигателя	LINER KIT Liner Kit Kit de Chemise Camisas de los cilindros лайнер комплект	CYL. LINER Zylinderlaufbuchse Chemise Camisas de los cilindros втулка цилиндра	PISTON + RINGS Kolben + Ringe Piston + Segments Pistón Set Поршень и кольца			PISTON SET Kolben Set Set de Piston Pistón Set поршневой	RINGS SET Kolben Set Segments de Piston Anillos Set кольца	PIN Pin Axe Perno Пин		
<b>128 A/AC</b> <b>128 AR</b> <b>128 AS</b> 4 Cyl 86.0 mm Bore Ø 1,290 cc 		Length: Outside Ø: Flange Ø: flange depth	Length: 77.3 Comp: 34.7 Height: 0.6 -3.1			Top: 1.5 2nd: 2.0 3rd: 1st oil: 3.95 2nd oil: Ø: 22.0 Length: 69.0	O-RING			
						Reference no.:		Reference no.:	Reference no.:	Reference no.:
								<b>K-93449600</b> <b>M-0078000</b>	<b>5 880 040</b> <b>5 880 541</b> <b>5 880 542</b> <b>5 880 543</b> <b>5 880 547</b> <b>5 880 548</b> <b>5 880 549</b>	<b>0 588 0960</b> <b>M-00780N0</b>
NM-Germany Article no. Artikelnummer/ Modelo Número / статья НОМЕР	NM-Germany Article no.	NM-Germany Article no.	NM-Germany Article no.	NM-Germany Article no.	NM-Germany Article no.	NM-Germany Article no.	NM-Germany Article no.			
			KBSFI40235G	KBFI40235G	KRFI40235G					

FIAT

**GASOLINE**

ENGINE TYPE Motortyp Type de Moteur Tipo de motor Тип двигателя	LINER KIT Liner Kit Kit de Chemise Camisas de los cilindros лайнер комплект	CYL. LINER Zylinderlaufbuchse Chemise Camisas de los cilindros втулка цилиндра	PISTON + RINGS Kolben + Ringe Piston + Segments Pistón Set Поршень и кольца			PISTON SET Kolben Set Set de Piston Pistón Set поршневой	RINGS SET Kolben Set Segments de Piston Anillos Set кольца	PIN Pin Axe Perno Пин		
<b>138 A2</b> <b>138 A4</b> 4 Cyl 86.4 mm Bore Ø 1,498 cc 		Length: Outside Ø: Flange Ø: flange depth	Length: 74.0 Comp: 34.5 Height: -4.2			Top: 1.5 2nd: 2.0 3rd: 1st oil: 3.95 2nd oil: Ø: 22.0 Length: 68.5	O-RING			
						Reference no.:		Reference no.:	Reference no.:	Reference no.:
								<b>A-24184</b>		<b>G-0820970000</b> <b>M-00780N1</b>
NM-Germany Article no. Artikelnummer/ Modelo Número / статья НОМЕР	NM-Germany Article no.	NM-Germany Article no.	NM-Germany Article no.	NM-Germany Article no.	NM-Germany Article no.	NM-Germany Article no.	NM-Germany Article no.			
			KBSFI40236G	KBFI40236G	KRFI40236G					

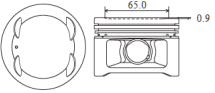
**GASOLINE**

ENGINE TYPE Motortyp Type de Moteur Tipo de motor Тип двигателя	LINER KIT Liner Kit Kit de Chemise Camisas de los cilindros лайнер комплект	CYL. LINER Zylinderlaufbuchse Chemise Camisas de los cilindros втулка цилиндра	PISTON + RINGS Kolben + Ringe Piston + Segments Pistón Set Поршень и кольца			PISTON SET Kolben Set Set de Piston Pistón Set поршневой	RINGS SET Kolben Set Segments de Piston Anillos Set кольца	PIN Pin Axe Perno Пин		
<b>1.6L 16V</b> 4 Cyl 86.4 mm Bore Ø 1,581 cc 		Length: Outside Ø: Flange Ø: flange depth	Length: 59.2 Comp: 34.1 Height: -0.9			Top: 1.5 2nd: 1.5 3rd: 1st oil: 3.0 2nd oil: Ø: 22.0 Length: 56.0	O-RING			
						Reference no.:		Reference no.:	Reference no.:	Reference no.:
								<b>M-S25600</b>	<b>M-E25600</b>	<b>M-A25600</b>
NM-Germany Article no. Artikelnummer/ Modelo Número / статья НОМЕР	NM-Germany Article no.	NM-Germany Article no.	NM-Germany Article no.	NM-Germany Article no.	NM-Germany Article no.	NM-Germany Article no.	NM-Germany Article no.			
			KBSFI40237G	KBFI40237G	KRFI40237G					

DIESEL						
ENGINE TYPE	LINER KIT	CYL. LINER	PISTON + RINGS	PISTON SET	RINGS SET	PIN
Motortyp Type de Moteur Tipo de motor Тип двигателя	Liner Kit Kit de Chemise Camisas de los cilindros лайнер комплект	Zylinderlaufbuchse Chemise Camisas de los cilindros втулка цилиндра	Kolben + Ringe Piston + Segments Pistón Set Поршень и кольца	Kolben Set Set de Piston Pistón Set поршеньюй	Kolben Set Segments de Piston Anillos Set кольца	Pin Axe Perno Пин
<b>F1AE 0481 A</b> <b>F1AE 0481 B</b> <b>F1AE 0481 C</b> 4 Cyl 88.0 mm Bore Ø 2,286 cc		Length: Outside Ø: Flange Ø: flange depth	Length: 84.0 Comp: 57.0 Height: -18.1	alfin and with oil gallery fits tapered con. rod	Top: 2.5 double keystone 2nd: 2.0 3rd: 1st oil: 2.5 2nd oil:	Ø: 31.0 Length: 67.0
			Reference no.:	Reference no.:	Reference no.:	O-RING
			<b>A-A350728</b> <b>K-40285600</b> <b>M-0098600</b> <b>N-8713800000</b>		<b>A-R66800</b> <b>G-0813800000</b> <b>K-800070740000</b> <b>M-00986N0</b>	
NM-Germany Article no. Artikelnummer/ Modelo Número / статья НОМЕР	NM-Germany Article no.	NM-Germany Article no.	NM-Germany Article no.	NM-Germany Article no.	NM-Germany Article no.	NM-Germany Article no.
			KBSFI40238DB	KBFI40238DB	KRFI40238DB	

DIESEL						
ENGINE TYPE	LINER KIT	CYL. LINER	PISTON + RINGS	PISTON SET	RINGS SET	PIN
Motortyp Type de Moteur Tipo de motor Тип двигателя	Liner Kit Kit de Chemise Camisas de los cilindros лайнер комплект	Zylinderlaufbuchse Chemise Camisas de los cilindros втулка цилиндра	Kolben + Ringe Piston + Segments Pistón Set Поршень и кольца	Kolben Set Set de Piston Pistón Set поршеньюй	Kolben Set Segments de Piston Anillos Set кольца	Pin Axe Perno Пин
<b>F1AE 0481 D/F</b> <b>F1AE 0481 G/H</b> <b>F1AE 0481 M/R</b> 4 Cyl 88.0 mm Bore Ø 2,286 cc		Length: Outside Ø: Flange Ø: flange depth	Length: 84.0 Comp: 57.0 Height: -13.75	alfin and with oil gallery fits tapered con. rod	Top: 2.5 double key- stone 2nd: 2.0 3rd: 1st oil: 2.5 2nd oil:	Ø: 31.0 Length: 67.0
			Reference no.:	Reference no.:	Reference no.:	O-RING
			<b>A-A354126</b> <b>K-40286600</b> <b>N-8713800010</b>		<b>A-R66800</b> <b>G-0813800000</b> <b>K-800070740000</b> <b>M-00986N0</b>	
NM-Germany Article no. Artikelnummer/ Modelo Número / статья НОМЕР	NM-Germany Article no.	NM-Germany Article no.	NM-Germany Article no.	NM-Germany Article no.	NM-Germany Article no.	NM-Germany Article no.
			KBSFI40239DB	KBFI40239DB	KRFI40239DB	

GASOLINE						
ENGINE TYPE	LINER KIT	CYL. LINER	PISTON + RINGS	PISTON SET	RINGS SET	PIN
Motortyp Type de Moteur Tipo de motor Тип двигателя	Liner Kit Kit de Chemise Camisas de los cilindros лайнер комплект	Zylinderlaufbuchse Chemise Camisas de los cilindros втулка цилиндра	Kolben + Ringe Piston + Segments Pistón Set Поршень и кольца	Kolben Set Set de Piston Pistón Set поршеньюй	Kolben Set Segments de Piston Anillos Set кольца	Pin Axe Perno Пин
<b>170 B</b> <b>170 D</b> 4 Cyl 88.0 mm Bore Ø 1,971 cc	<b>A-SA2494</b> <b>K-93908960</b>	Length: 135.5 Outside Ø: 92.95 Flange Ø: 101.9 collar depth 90.0	Length: 71.75 Comp: 38.25 Height: +0.65		Top: 1.5 2nd: 2.0 3rd: 1st oil: 4.0 2nd oil:	Ø: 23.0 Length: 74.0
			Reference no.:	Reference no.:	Reference no.:	O-RING
			<b>K-88589110</b> <b>M-039WN13</b>	<b>K-93908600</b>	<b>A-R66110</b> <b>G-0831690000</b> <b>K-800003841000</b> <b>M-03953N0</b> <b>T-50023</b>	<b>K-50006663</b>
NM-Germany Article no. Artikelnummer/ Modelo Número / статья НОМЕР	NM-Germany Article no.	NM-Germany Article no.	NM-Germany Article no.	NM-Germany Article no.	NM-Germany Article no.	NM-Germany Article no.
	LBSFI40240GF	LBFI40240GF	KBSFI40240G	KBFI40240G	KRFI40240G	ORFI40240G

**DIESEL**

ENGINE TYPE Motortyp Type de Moteur Tipo de motor Тип двигателя	LINER KIT Liner Kit Kit de Chemise Camisas de los cilindros лайнер комплект	CYL. LINER Zylinderlaufbuchse Chemise Camisas de los cilindros втулка цилиндра	PISTON + RINGS Kolben + Ringe Piston + Segments Pistón Set Поршень и кольца		PISTON SET Kolben Set Set de Piston Pistón Set поршневой	RINGS SET Kolben Set Segments de Piston Anillos Set кольца	PIN Pin Axe Perno Пин
<b>D 3.152</b> <b>D 4.203</b> 3/4 Cyl 91.48 mm Bore Ø 2,503 cc 3,335 cc	<b>K-92772964</b>	Length: 216.0 Outside Ø: 93.67 Flange Ø: 96.7 flange depth 3.76	Length: 109.6 Comp: 61.9 Height: -10.25 -18.4			Top: 2.385 2nd: 2.385 3rd: 3.16 1st oil: 6.335 2nd oil: 6.335	Ø: 31.75 Length: 75.0
		Reference no.:		Reference no.:	Reference no.:	Reference no.:	O-RING
		<b>313 583 22</b> <b>313 583 45</b> <b>G-1402296000</b> <b>K-88552110</b> <b>M-043WT08</b>		<b>A-350245</b> <b>K-92772600</b> <b>M-0432400</b> <b>N-8752510000</b>	<b>313 546 12</b>	<b>A-R34550</b> <b>A-R34560K</b> <b>G-0831460000</b> <b>G-0852510000</b> <b>K-800015711000</b> <b>M-04321V0</b>	
NM-Germany Article no. Artikelnummer/ Modelo Número / статья НОМЕР	NM-Germany Article no.	NM-Germany Article no.	NM-Germany Article no.	NM-Germany Article no.	NM-Germany Article no.	NM-Germany Article no.	NM-Germany Article no.
	LBSFI340241DF	LBFI340241DF	KBSFI340241D	KBFI340241D	KRFI340241D		

FIAT

**DIESEL**

ENGINE TYPE Motortyp Type de Moteur Tipo de motor Тип двигателя	LINER KIT Liner Kit Kit de Chemise Camisas de los cilindros лайнер комплект	CYL. LINER Zylinderlaufbuchse Chemise Camisas de los cilindros втулка цилиндра	PISTON + RINGS Kolben + Ringe Piston + Segments Pistón Set Поршень и кольца		PISTON SET Kolben Set Set de Piston Pistón Set поршневой	RINGS SET Kolben Set Segments de Piston Anillos Set кольца	PIN Pin Axe Perno Пин
<b>DJ5 T</b> <b>DK5 ATE</b> 4 Cyl 92.0 mm Bore Ø 2,446 cc		Length: 49.84 Outside Ø: Flange Ø: flange depth	Length: 82.0 Comp: -2.3 Height: 49.47 -2.3	STD O/S 81.6	alfin and with oil gallery head anodized skirt MOS2 treated fits tapered con. rod	Top: 3.0 double keystone 2nd: 1.75 3rd: 1st oil: 3.5 2nd oil:	Ø: 34.0 Length: 68.0
		Reference no.:		Reference no.:	Reference no.:	Reference no.:	O-RING
				<b>A-A354071</b> <b>K-91313700</b> <b>M-0390600</b>		<b>A-R67430</b> <b>G-0832630000</b> <b>K-800059940000</b> <b>M-03906N0</b>	
NM-Germany Article no. Artikelnummer/ Modelo Número / статья НОМЕР	NM-Germany Article no.	NM-Germany Article no.	NM-Germany Article no.	NM-Germany Article no.	NM-Germany Article no.	NM-Germany Article no.	NM-Germany Article no.
			KBSFI40242DB	KBFI40242DB	KRFI40242DB		

**DIESEL**

ENGINE TYPE Motortyp Type de Moteur Tipo de motor Тип двигателя	LINER KIT Liner Kit Kit de Chemise Camisas de los cilindros лайнер комплект	CYL. LINER Zylinderlaufbuchse Chemise Camisas de los cilindros втулка цилиндра	PISTON + RINGS Kolben + Ringe Piston + Segments Pistón Set Поршень и кольца		PISTON SET Kolben Set Set de Piston Pistón Set поршневой	RINGS SET Kolben Set Segments de Piston Anillos Set кольца	PIN Pin Axe Perno Пин
<b>8140.67</b> <b>8140.67</b> 4 Cyl 93.0 mm Bore Ø 2,499 cc	<b>M-0070490</b>	Length: 171.0 Outside Ø: 96.0 Flange Ø: 98.9 flange depth 5.0	Length: 96.8 Comp: 58.8 Height: -13.1 -17.8		alfin	Top: 3.0 double keystone 2nd: 2.0 3rd: 1st oil: 3.0 2nd oil:	Ø: 32.0 Length: 74.0
		Reference no.:		Reference no.:	Reference no.:	Reference no.:	O-RING
		<b>7 302 454</b> <b>K-89319190</b> <b>M-007WV46</b>		<b>K-94327700</b> <b>M-0070400</b>		<b>7 302 172</b> <b>7 302 173</b> <b>A-R47080</b> <b>G-0824520000</b> <b>K-800006840000</b> <b>M-00805V0</b>	
NM-Germany Article no. Artikelnummer/ Modelo Número / статья НОМЕР	NM-Germany Article no.	NM-Germany Article no.	NM-Germany Article no.	NM-Germany Article no.	NM-Germany Article no.	NM-Germany Article no.	NM-Germany Article no.
	LBSFI40243DSA	LBFI40243DSA	KBSFI40243DA	KBFI40243DA	KRFI40243DA		

## DIESEL

ENGINE TYPE Motortyp Type de Moteur Tipo de motor Тип двигателя	LINER KIT Liner Kit Kit de Chemise Camisas de los cilindros лайнер комплект	CYL. LINER Zylinderlaufbuchse Chemise Camisas de los cilindros втулка цилиндра			PISTON + RINGS Kolben + Ringe Piston + Segments Pistón Set Поршень и кольца	PISTON SET Kolben Set Set de Piston Pistón Set поршневой	RINGS SET Kolben Set Segments de Piston Anillos Set кольца	PIN Pin Axe Perno Пин					
<b>8142.614</b> <b>8140.61</b> <b>8142.61</b> 4 Cyl 93.0 mm Bore Ø 2,429 cc 2,445 cc	<b>(A)</b> <b>K-93378970</b> <b>M-0079890</b> consists of (C)	Length: 167.0 167.3 Outside Ø: 96.0 96.0 Flange Ø: 98.9 flange depth 5.0	(C)	(D)	Length: 89.8 Comp: 54.7 Height: -2.0	alfin head anodized	Top: 3.0 2nd: 2.0 3rd: 4.0 1st oil: 2nd oil:	Ø: 32.0 Length: 74.4					
									Reference no.:	Reference no.:	Reference no.:	Reference no.:	O-RING
									<b>(C)</b> <b>A-SU351407</b> <b>K-89066190</b> <b>M-007WV39</b>	<b>A-A350663</b> <b>K-93378700</b> <b>M-0079800</b> <b>N-8721450000</b>	<b>7 301 503</b> <b>7 031 808</b> <b>7 301 811</b> <b>7 301 815/887</b> <b>7 301 923/926</b> <b>7 302 280/290</b>	<b>7 301 400</b> <b>7 301 402</b> <b>7 301 403</b> <b>7 301 499</b> <b>A-R47010</b> <b>G-0821450010</b> <b>K-800007040000</b> <b>M-00798V0</b>	
<b>(D)</b> <b>G-1402256000</b> <b>K-89183190</b> <b>M-007WV43</b>													
NM-Germany Article no. Artikelnummer/ Modelo Número / статья НОМЕР	NM-Germany Article no.	NM-Germany Article no.	NM-Germany Article no.	NM-Germany Article no.	NM-Germany Article no.	NM-Germany Article no.	NM-Germany Article no.	NM-Germany Article no.					
	LBSFI40244DAP (A) LBSFI40244DAS (B)	LBF40244DAP (C) LBF40244DAS (D)	KBSFI40244DA	KBFI40244DA	KRFI40244DA								

## DIESEL

ENGINE TYPE Motortyp Type de Moteur Tipo de motor Тип двигателя	LINER KIT Liner Kit Kit de Chemise Camisas de los cilindros лайнер комплект	CYL. LINER Zylinderlaufbuchse Chemise Camisas de los cilindros втулка цилиндра			PISTON + RINGS Kolben + Ringe Piston + Segments Pistón Set Поршень и кольца	PISTON SET Kolben Set Set de Piston Pistón Set поршневой	RINGS SET Kolben Set Segments de Piston Anillos Set кольца	PIN Pin Axe Perno Пин					
<b>8140.21 TURBO</b> <b>8144.21 TURBO</b> 4 Cyl 93.0 mm Bore Ø 2,445 cc	<b>K-93123960</b> <b>M-0080592</b>	Length: 171.0 Outside Ø: 96.0 Flange Ø: 98.9 flange depth 5.0			Length: 97.65 Comp: 59.65 Height: -5.8 -14.8	alfin	Top: 3.0 double key-stone 2nd: 2.0 3rd: 3.0 1st oil: 2nd oil:	Ø: 32.0 Length: 75.2					
									Reference no.:	Reference no.:	Reference no.:	Reference no.:	O-RING
									<b>7 302 454</b> <b>A-SU351419</b> <b>K-89319190</b> <b>M-007WV46</b> <b>N-1402137100</b>	<b>A-A350671</b> <b>K-93123600</b> <b>M-0080500</b> <b>N-8724520030</b>	<b>7 303 023</b>	<b>7 302 172</b> <b>7 302 173</b> <b>A-R47080</b> <b>G-0824520000</b> <b>K-800006840000</b> <b>M-00805V0</b>	
<b>(D)</b> <b>G-1402256000</b> <b>K-89183190</b> <b>M-007WV43</b>													
NM-Germany Article no. Artikelnummer/ Modelo Número / статья НОМЕР	NM-Germany Article no.	NM-Germany Article no.	NM-Germany Article no.	NM-Germany Article no.	NM-Germany Article no.	NM-Germany Article no.	NM-Germany Article no.	NM-Germany Article no.					
	LBSFI40245DSA	LBF40245DSA	KBSFI40245DA	KBFI40245DA	KRFI40245DA								

## DIESEL

ENGINE TYPE Motortyp Type de Moteur Tipo de motor Тип двигателя	LINER KIT Liner Kit Kit de Chemise Camisas de los cilindros лайнер комплект	CYL. LINER Zylinderlaufbuchse Chemise Camisas de los cilindros втулка цилиндра			PISTON + RINGS Kolben + Ringe Piston + Segments Pistón Set Поршень и кольца	PISTON SET Kolben Set Set de Piston Pistón Set поршневой	RINGS SET Kolben Set Segments de Piston Anillos Set кольца	PIN Pin Axe Perno Пин					
<b>8140.27 TURBO</b> <b>8144.40 TURBO</b> <b>8144.47 TURBO</b> 4 Cyl 93.0 mm Bore Ø 2,499 cc	<b>K-94382960</b> <b>M-0090790</b>	Length: 171.0 Outside Ø: 96.0 Flange Ø: 98.9 flange depth 5.0			Length: 96.75 Comp: 58.75 Height: -14.0 -18.4	alfin and with oil gallery skirt MOS2 treated pin bushing inserted	Top: 3.0 double keystone 2nd: 2.0 3rd: 3.0 1st oil: 2nd oil:	Ø: 32.0 Length: 78.1					
									Reference no.:	Reference no.:	Reference no.:	Reference no.:	O-RING
									<b>7 302 454</b> <b>A-SU351419</b> <b>K-89319190</b> <b>M-007WV46</b> <b>N-1402137100</b>	<b>A-A350510</b> <b>K-94382600</b> <b>M-0090700</b>		<b>7 302 172</b> <b>7 302 173</b> <b>A-R47080</b> <b>G-0824520000</b> <b>K-800006840000</b> <b>M-00805V0</b>	
<b>(D)</b> <b>G-1402256000</b> <b>K-89183190</b> <b>M-007WV43</b>													
NM-Germany Article no. Artikelnummer/ Modelo Número / статья НОМЕР	NM-Germany Article no.	NM-Germany Article no.	NM-Germany Article no.	NM-Germany Article no.	NM-Germany Article no.	NM-Germany Article no.	NM-Germany Article no.	NM-Germany Article no.					
	LBSFI40246DSB	LBF40246DSB	KBSFI40246DB	KBFI40246DB	KRFI40246DB								

## DIESEL

ENGINE TYPE Motortyp Type de Moteur Tipo de motor Тип двигателя	LINER KIT Liner Kit Kit de Chemise Camisas de los cilindros лайнер комплект	CYL. LINER Zylinderlaufbuchse Chemise Camisas de los cilindros втулка цилиндра	PISTON + RINGS Kolben + Ringe Piston + Segments Pistón Set Поршень и кольца			PISTON SET Kolben Set Set de Piston Pistón Set поршневой	RINGS SET Kolben Set Segments de Piston Anillos Set кольца	PIN Pin Axe Perno Пин				
<b>B 25 CRD 93 U25</b> 4 Cyl 93.01 mm Bore Ø 2,499 cc	<b>K-93844970 M-0318290</b>	Length: 163.0 Outside Ø: 97.5 Flange Ø: 99.0 flange depth 5.0	Length: 95.0 Comp: 52.75 Height: -7.4			Top: 2.5 2nd: 2.0 3rd: 4.0 1st oil: 2nd oil:	Ø: 30.0 Length: 78.0					
								Reference no.:	Reference no.:	Reference no.:	Reference no.:	O-RING
								<b>K-89073190 M-031WV16</b>	<b>A-350704 K-93844700 M-0318200 N-8715270000</b>		<b>A-R60970 G-0815270000 K-800004041000 M-03182N0</b>	
NM-Germany Article no. Artikelnummer/ Modelo Número / статья НОМЕР	NM-Germany Article no.	NM-Germany Article no.	NM-Germany Article no.	NM-Germany Article no.	NM-Germany Article no.	NM-Germany Article no.						
	<b>LBSFI40247DS</b>	<b>LBF140247DS</b>	<b>KBSFI40247D</b>	<b>KBF140247D</b>	<b>KRF140247D</b>							

FIAT

## DIESEL

ENGINE TYPE Motortyp Type de Moteur Tipo de motor Тип двигателя	LINER KIT Liner Kit Kit de Chemise Camisas de los cilindros лайнер комплект	CYL. LINER Zylinderlaufbuchse Chemise Camisas de los cilindros втулка цилиндра	PISTON + RINGS Kolben + Ringe Piston + Segments Pistón Set Поршень и кольца			PISTON SET Kolben Set Set de Piston Pistón Set поршневой	RINGS SET Kolben Set Segments de Piston Anillos Set кольца	PIN Pin Axe Perno Пин				
<b>8140.23 TURBO 8140.43 TURBO</b> 4 Cyl 94.4 mm Bore Ø 2,798 cc	<b>K-94701960 M-0098990</b>	Length: 167.0 Outside Ø: 97.5 Flange Ø: 100.9 flange depth 5.0	Length: 87.6 Comp: 58.8 Height: -15.1 -19.45		alfin and with oil gallery skirt MOS2 treated fits tapered con. rod	Top: 2.5 double key- stone 2nd: 2.0 3rd: 2.5 1st oil: 2nd oil:	Ø: 32.0 Length: 72.0					
								Reference no.:	Reference no.:	Reference no.:	Reference no.:	O-RING
								<b>G-1402839000 K-89502190 M-007WV56</b>	<b>A-A350582 K-94701600 M-00989900</b>		<b>A-R60070 G-0812220000 K-800038241000 M-00990N0</b>	
NM-Germany Article no. Artikelnummer/ Modelo Número / статья НОМЕР	NM-Germany Article no.	NM-Germany Article no.	NM-Germany Article no.	NM-Germany Article no.	NM-Germany Article no.	NM-Germany Article no.						
	<b>LBSFI40248DSB</b>	<b>LBF140248DSB</b>	<b>KBSFI40248DB</b>	<b>KBF140248DB</b>	<b>KRF140248DB</b>							

## DIESEL

ENGINE TYPE Motortyp Type de Moteur Tipo de motor Тип двигателя	LINER KIT Liner Kit Kit de Chemise Camisas de los cilindros лайнер комплект	CYL. LINER Zylinderlaufbuchse Chemise Camisas de los cilindros втулка цилиндра	PISTON + RINGS Kolben + Ringe Piston + Segments Pistón Set Поршень и кольца			PISTON SET Kolben Set Set de Piston Pistón Set поршневой	RINGS SET Kolben Set Segments de Piston Anillos Set кольца	PIN Pin Axe Perno Пин				
<b>F1CE 0481 HA F1CE 0481 HC</b> 4 Cyl 95.8 mm Bore Ø 2,998 cc		Length: 92.9 Outside Ø: 63.0 Flange Ø: -16.0 flange depth	Length: 92.9 Comp: 63.0 Height: -16.0		alfin and with oil gallery fits tapered con. rod	Top: 2.5 double key- stone 2nd: 2.0 3rd: 2.5 1st oil: 2nd oil:	Ø: 36.0 Length: 81.0					
								Reference no.:	Reference no.:	Reference no.:	Reference no.:	O-RING
									<b>K-40510600</b>		<b>K-800057810000</b>	
NM-Germany Article no. Artikelnummer/ Modelo Número / статья НОМЕР	NM-Germany Article no.	NM-Germany Article no.	NM-Germany Article no.	NM-Germany Article no.	NM-Germany Article no.	NM-Germany Article no.						
			<b>KBSFI40249DB</b>	<b>KBF140249DB</b>	<b>KRF140249DB</b>							

### DIESEL

ENGINE TYPE Motortyp Type de Moteur Tipo de motor Тип двигателя	LINER KIT Liner Kit Kit de Chemise Camisas de los cilindros лайнер комплект	CYL. LINER Zylinderlaufbuchse Chemise Camisas de los cilindros втулка цилиндра	PISTON + RINGS Kolben + Ringe Piston + Segments Pistón Set Поршень и кольца	PISTON SET Kolben Set Set de Piston Pistón Set поршневой	RINGS SET Kolben Set Segments de Piston Anillos Set кольца	PIN Pin Axe Perno Пин
<b>4.236</b> <b>4 Cyl</b> <b>98.48 mm Bore Ø</b> <b>3,864 cc</b>	<b>K-93592962</b>	Length: 227.4	Length: 121.0	alfin head anodized skirt MOS2 treated	Top: 2.385	Ø: 34.93 Length: 84.0
		Outside Ø: 103.22	Comp: 70.3		2nd: 2.385	
		Flange Ø: 106.36	Height: -20.5		3rd: 4.747	
flange depth 3.8 +1.0		1st oil: 4.747	2nd oil:			
<b>Reference no.:</b>		<b>Reference no.:</b>		<b>Reference no.:</b>		<b>O-RING</b>
<b>K-88355190</b> <b>M-043WV12</b>		<b>K-93592600</b> <b>M-0433100</b>		<b>A-R34740</b> <b>G-0831890010</b> <b>K-800033710000</b> <b>M-04331N0</b>		
NM-Germany Article no. Artikelnummer/ Modelo Número / статья НОМЕР	NM-Germany Article no.	NM-Germany Article no.	NM-Germany Article no.	NM-Germany Article no.	NM-Germany Article no.	NM-Germany Article no.
	<b>LBSFI40250DSA</b>	<b>LBFI40250DSA</b>	<b>KBSFI40250DA</b>	<b>KBFI40250DA</b>	<b>KRFI40250DA</b>	

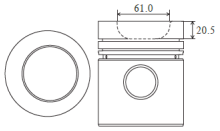

### DIESEL

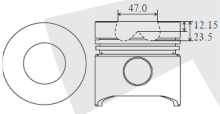

ENGINE TYPE Motortyp Type de Moteur Tipo de motor Тип двигателя	LINER KIT Liner Kit Kit de Chemise Camisas de los cilindros лайнер комплект	CYL. LINER Zylinderlaufbuchse Chemise Camisas de los cilindros втулка цилиндра	PISTON + RINGS Kolben + Ringe Piston + Segments Pistón Set Поршень и кольца	PISTON SET Kolben Set Set de Piston Pistón Set поршневой	RINGS SET Kolben Set Segments de Piston Anillos Set кольца	PIN Pin Axe Perno Пин
<b>8025.02</b> <b>8030.02/8035.02</b> <b>8040.03/8045.02</b> <b>8060.02/8065.02</b> <b>2/3/4/6 Cyl</b> <b>100.0 mm Bore Ø</b> <b>1,728 cc 2,592 cc</b> <b>3,456 cc 5,184 cc</b>	<b>K-92628960</b> <b>M-0079790</b>	Length: 187.0	Length: 101.15		Top: 2.5	Ø: 32.0 Length: 83.4
		Outside Ø: 103.0	Comp: 59.65		2nd: 2.5	
		Flange Ø:	Height: -12.15		3rd: 5.5	
flange depth		-23.5				
<b>Reference no.:</b>		<b>Reference no.:</b>		<b>Reference no.:</b>		<b>O-RING</b>
<b>G-1401017000</b> <b>K-88631190</b> <b>M-007WV09</b>		<b>A-350617</b> <b>K-92628600</b> <b>M-0079700</b> <b>N-8720680000</b>		<b>A-R46830</b> <b>G-0820680000</b> <b>M-00797V0</b>		
NM-Germany Article no. Artikelnummer/ Modelo Número / статья НОМЕР	NM-Germany Article no.	NM-Germany Article no.	NM-Germany Article no.	NM-Germany Article no.	NM-Germany Article no.	NM-Germany Article no.
	<b>LBSFI23460251DP</b>	<b>LBFI23460251DP</b>	<b>KBSFI23460251D</b>	<b>KBFI23460251D</b>	<b>KRFI23460251D</b>	

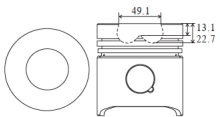

### DIESEL

ENGINE TYPE Motortyp Type de Moteur Tipo de motor Тип двигателя	LINER KIT Liner Kit Kit de Chemise Camisas de los cilindros лайнер комплект	CYL. LINER Zylinderlaufbuchse Chemise Camisas de los cilindros втулка цилиндра	PISTON + RINGS Kolben + Ringe Piston + Segments Pistón Set Поршень и кольца	PISTON SET Kolben Set Set de Piston Pistón Set поршневой	RINGS SET Kolben Set Segments de Piston Anillos Set кольца	PIN Pin Axe Perno Пин
<b>8035.06</b> <b>8045.06</b> <b>8065.06</b> <b>3/4/6 Cyl</b> <b>100.0 mm Bore Ø</b> <b>2,708 cc 3,613 cc</b> <b>5,418 cc</b>	<b>K-99567960</b> <b>M-0081890</b>	Length: 196.0	Length: 108.5		Top: 2.5	Ø: 38.0 Length: 85.0
		Outside Ø: 103.0	Comp: 65.1		2nd: 2.5	
		Flange Ø:	Height: -13.1		3rd: 4.0	
flange depth		-22.7				
<b>Reference no.:</b>		<b>Reference no.:</b>		<b>Reference no.:</b>		<b>O-RING</b>
<b>G-1401078000</b> <b>K-89608190</b> <b>M-007WV47</b>		<b>A-350622</b> <b>K-99567600</b> <b>M-0081800</b> <b>N-8778190010</b>		<b>A-R47070</b> <b>G-0878190000</b> <b>K-800043411000</b> <b>M-01003N0</b>		
NM-Germany Article no. Artikelnummer/ Modelo Número / статья НОМЕР	NM-Germany Article no.	NM-Germany Article no.	NM-Germany Article no.	NM-Germany Article no.	NM-Germany Article no.	NM-Germany Article no.
	<b>LBSFI3460252DP</b>	<b>LBFI3460252DP</b>	<b>KBSFI3460252D</b>	<b>KBFI3460252D</b>	<b>KRFI3460252D</b>	

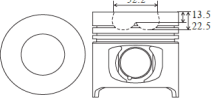

ENGINE TYPE Motortyp Type de Moteur Tipo de motor Тип двигателя	LINER KIT Liner Kit Kit de Chemise Camisas de los cilindros лайнер комплект	CYL. LINER Zylinderlaufbuchse Chemise Camisas de los cilindros втулка цилиндра	PISTON + RINGS Kolben + Ringe Piston + Segments Pistón Set Поршень и кольца		PISTON SET Kolben Set Set de Piston Pistón Set поршневой	RINGS SET Kolben Set Segments de Piston Anillos Set кольца	PIN Pin Axe Perno Пин				
<b>8031.05/8035.05</b> <b>8040.05/8045.06</b> <b>8055.05</b> <b>8060.05/8065.05</b> 3/4/5/6 Cyl 104.0 mm Bore Ø 2,931 cc 3,908 cc 4,885 cc 5,861 cc	<b>(A)</b> <b>M-0083790</b> consists of (E)	(E)	(F)	Length: 108.5 Comp: 65.15 Height: -13.5 -22.5	(I) fits tapered con. rod  (J) alfin fits tapered con. rod	Top: 2.5 2nd: 2.5 3rd: 4.0 1st oil: 2nd oil:	Ø: 38.0 Length: 85.0				
		Length: 198.0	198.0					Outside Ø: 107.0	107.0	Flange Ø: 109.8	flange depth: 5.0
		Reference no.:						Reference no.:		Reference no.:	
	<b>(B)</b> <b>K-90158970</b> <b>M-0083590</b> consists of (E)	<b>(E)</b> <b>A-SU351420</b> <b>K-89326190</b> <b>M-007WV48</b>	<b>(G)</b> <b>M-0083700</b>	<b>(I)</b> fits tapered con. rod	<b>A-R47200</b> <b>G-0824780000</b> <b>K-800007510000</b> <b>M-00835N0</b>						
								<b>(F)</b> <b>A-SU351414</b> <b>K-89317190</b> <b>M-007WV49</b>	<b>(H)</b> <b>A-A350682</b> <b>K-90158700</b> <b>M-0083500</b>	<b>(J)</b> alfin fits tapered con. rod	
											Reference no.:
NM-Germany Article no. Artikelnummer/ Modelo Número / статья НОМЕР	NM-Germany Article no.	NM-Germany Article no.	NM-Germany Article no.	NM-Germany Article no.	NM-Germany Article no.	NM-Germany Article no.	NM-Germany Article no.				
	LBSFI34560253DP (A)										
	LBSFI34560253DPA (B)	LBFI34560253DP (E)	KBSFI34560253D (G)	KBFI34560253D (I)		KRFI34560253D					
	LBSFI34560253DS (C)	LBFI34560253DS (F)	KBSFI34560253DA (H)	KBFI34560253DA (J)							
	LBSFI34560253DSA (D)										

## GASOLINE

ENGINE TYPE Motortyp Type de Moteur Tipo de motor Тип двигателя	LINER KIT Liner Kit Kit de Chemise Camisas de los cilindros лайнер комплект	CYL. LINER Zylinderlaufbuchse Chemise Camisas de los cilindros втулка цилиндра	PISTON + RINGS Kolben + Ringe Piston + Segments Pistón Set Поршень и кольца			PISTON SET Kolben Set Set de Piston Pistón Set поршневой	RINGS SET Kolben Set Segments de Piston Anillos Set кольца	PIN Pin Axe Perno Пин					
<b>G6A GUF</b> 4 Cyl 68.7 mm Bore Ø 1,119 cc		Length: Outside Ø: Flange Ø: flange depth	Length: Comp: Height:	53.9 29.4 -3.5		Top: 2nd: 3rd: 1st oil: 2nd oil:	1.5 1.75 3.0	Ø: 18.0 Length: 59.0					
									Reference no.:	Reference no.:	Reference no.:	Reference no.:	O-RING
										<b>A-24016</b> <b>K-92079700</b> <b>M-0145700</b> <b>N-8778410010</b>	<b>89BM-6110N2C</b>	<b>89BM-6148AA</b> <b>A-R43430</b> <b>G-0878410000</b> <b>K-800035040000</b> <b>M-01456N0</b>	
NM-Germany Article no. Artikelnummer/ Modelo Número / статья НОМЕР	NM-Germany Article no.	NM-Germany Article no.	NM-Germany Article no.	NM-Germany Article no.	NM-Germany Article no.	NM-Germany Article no.	NM-Germany Article no.						
			<b>KBSFO40254G</b>	<b>KBFO40254G</b>	<b>KRFO40254G</b>								

## GASOLINE

ENGINE TYPE Motortyp Type de Moteur Tipo de motor Тип двигателя	LINER KIT Liner Kit Kit de Chemise Camisas de los cilindros лайнер комплект	CYL. LINER Zylinderlaufbuchse Chemise Camisas de los cilindros втулка цилиндра	PISTON + RINGS Kolben + Ringe Piston + Segments Pistón Set Поршень и кольца			PISTON SET Kolben Set Set de Piston Pistón Set поршневой	RINGS SET Kolben Set Segments de Piston Anillos Set кольца	PIN Pin Axe Perno Пин					
<b>ZETEC ROCAM</b> 4 Cyl 68.7 mm Bore Ø 999 cc		Length: Outside Ø: Flange Ø: flange depth	Length: Comp: Height:	53.88 28.88 -3.0	skirt MOS2 treated	Top: 2nd: 3rd: 1st oil: 2nd oil:	1.2 1.5 2.0	Ø: 18.03 Length: 44.0					
									Reference no.:	Reference no.:	Reference no.:	Reference no.:	O-RING
										<b>M-S59560</b>	<b>M-E59560</b>	<b>M-A59870</b>	
NM-Germany Article no. Artikelnummer/ Modelo Número / статья НОМЕР	NM-Germany Article no.	NM-Germany Article no.	NM-Germany Article no.	NM-Germany Article no.	NM-Germany Article no.	NM-Germany Article no.	NM-Germany Article no.						
			<b>KBSFO40255G</b>	<b>KBFO40255G</b>	<b>KRFO40255G</b>								

## GASOLINE

ENGINE TYPE Motortyp Type de Moteur Tipo de motor Тип двигателя	LINER KIT Liner Kit Kit de Chemise Camisas de los cilindros лайнер комплект	CYL. LINER Zylinderlaufbuchse Chemise Camisas de los cilindros втулка цилиндра	PISTON + RINGS Kolben + Ringe Piston + Segments Pistón Set Поршень и кольца			PISTON SET Kolben Set Set de Piston Pistón Set поршневой	RINGS SET Kolben Set Segments de Piston Anillos Set кольца	PIN Pin Axe Perno Пин					
<b>HCS 1.0L GUD GUE</b> 4 Cyl 68.7 mm Bore Ø 1,005 cc 1,119 cc		Length: Outside Ø: Flange Ø: flange depth	Length: Comp: Height:	54.0 29.4 0		Top: 2nd: 3rd: 1st oil: 2nd oil:	1.5 1.75 3.0	Ø: 18.0 Length: 59.0					
									Reference no.:	Reference no.:	Reference no.:	Reference no.:	O-RING
										<b>A-23512</b> <b>K-92054700</b> <b>M-0145600</b> <b>M-S59500</b> <b>N-8778410000</b>	<b>89BM-6102AA</b> <b>89BM-6102BA</b> <b>89BM-6102CA</b> <b>89BM-6110B2C</b> <b>M-E59500</b>	<b>89BM-6148AA</b> <b>A-R43430</b> <b>G-0878410000</b> <b>K-800035040000</b> <b>M-01456N0</b>	
NM-Germany Article no. Artikelnummer/ Modelo Número / статья НОМЕР	NM-Germany Article no.	NM-Germany Article no.	NM-Germany Article no.	NM-Germany Article no.	NM-Germany Article no.	NM-Germany Article no.	NM-Germany Article no.						
			<b>KBSFO40256G</b>	<b>KBFO40256G</b>	<b>KRFO40256G</b>								



**GASOLINE**

ENGINE TYPE Motortyp Type de Moteur Tipo de motor Тип двигателя	LINER KIT Liner Kit Kit de Chemise Camisas de los cilindros лайнер комплект	CYL. LINER Zylinderlaufbuchse Chemise Camisas de los cilindros втулка цилиндра	PISTON + RINGS Kolben + Ringe Piston + Segments Pistón Set Поршень и кольца			PISTON SET Kolben Set Set de Piston Pistón Set поршневой	RINGS SET Kolben Set Segments de Piston Anillos Set кольца	PIN Pin Axe Perno Пин	
<b>AE</b> 4 Cyl 70.3 mm Bore Ø 1,000 cc		Length: Outside Ø: Flange Ø: flange depth	Length:	61.8			Top:	1.5	Ø: 20.0 Length: 54.0
			Comp:	33.8			2nd:	1.5	
			Height:	-2.8			3rd:		
			Reference no.:	Reference no.:	Reference no.:	Reference no.:	O-RING		
				<b>M-S59490</b>	<b>M-E59490</b>	<b>M-A59490</b>			
NM-Germany Article no. Artikelnummer/ Modelo Número / статья НОМЕР	NM-Germany Article no.	NM-Germany Article no.	NM-Germany Article no.	NM-Germany Article no.	NM-Germany Article no.	NM-Germany Article no.	NM-Germany Article no.		
			<b>KBSFO40257G</b>	<b>KBFO40257G</b>	<b>KRFO40257G</b>				

ENGINE TYPE Motortyp Type de Moteur Tipo de motor Тип двигателя	LINER KIT Liner Kit Kit de Chemise Camisas de los cilindros лайнер комплект	CYL. LINER Zylinderlaufbuchse Chemise Camisas de los cilindros втулка цилиндра	PISTON + RINGS Kolben + Ringe Piston + Segments Pistón Set Поршень и кольца			PISTON SET Kolben Set Set de Piston Pistón Set поршневой	RINGS SET Kolben Set Segments de Piston Anillos Set кольца	PIN Pin Axe Perno Пин	
<b>F6JA</b> <b>F6JB</b> 4 Cyl 73.7 mm Bore Ø 1,398 cc		Length: 137.0 Outside Ø: 76.78 Flange Ø: 78.7 flange depth 4.0	Length:	65.44			Top:	2.5	Ø: 25.0 Length: 60.0
			Comp:	42.94			double key-		
			Height:	-8.5			stone		
			Reference no.:	Reference no.:	Reference no.:	Reference no.:	O-RING		
				<b>A-A354118</b> <b>K-40469600</b> <b>M-0400300</b> <b>N-8713530000</b>		<b>A-R66770</b> <b>G-0813530000</b> <b>K-800046040000</b> <b>M-04005N0</b>			
NM-Germany Article no. Artikelnummer/ Modelo Número / статья НОМЕР	NM-Germany Article no.	NM-Germany Article no.	NM-Germany Article no.	NM-Germany Article no.	NM-Germany Article no.	NM-Germany Article no.	NM-Germany Article no.		
	<b>LBSFO40258DSA</b>	<b>LBFO40258DSA</b>	<b>KBSFO40258DA</b>	<b>KBFO40258DA</b>	<b>KRFO40258DA</b>				

FORD

**GASOLINE**

ENGINE TYPE Motortyp Type de Moteur Tipo de motor Тип двигателя	LINER KIT Liner Kit Kit de Chemise Camisas de los cilindros лайнер комплект	CYL. LINER Zylinderlaufbuchse Chemise Camisas de los cilindros втулка цилиндра	PISTON + RINGS Kolben + Ringe Piston + Segments Pistón Set Поршень и кольца			PISTON SET Kolben Set Set de Piston Pistón Set поршневой	RINGS SET Kolben Set Segments de Piston Anillos Set кольца	PIN Pin Axe Perno Пин	
<b>ZL13</b> 4 Cyl 73.96 mm Bore Ø 1,299 cc		Length: Outside Ø: Flange Ø: flange depth	Length:	48.9			Top:	1.2	Ø: 18.034 Length: 53.5
			Comp:	24.9			2nd:	1.5	
			Height:	-2.8			3rd:		
			Reference no.:	Reference no.:	Reference no.:	Reference no.:	O-RING		
				<b>K-99837600</b>		<b>K-800038340000</b>			
NM-Germany Article no. Artikelnummer/ Modelo Número / статья НОМЕР	NM-Germany Article no.	NM-Germany Article no.	NM-Germany Article no.	NM-Germany Article no.	NM-Germany Article no.	NM-Germany Article no.	NM-Germany Article no.		
			<b>KBSFO40259G</b>	<b>KBFO40259G</b>	<b>KRFO40259G</b>				

**GASOLINE**

ENGINE TYPE Motortyp Type de Moteur Tipo de motor Тип двигателя	LINER KIT Liner Kit Kit de Chemise Camisas de los cilindros лайнер комплект	CYL. LINER Zylinderlaufbuchse Chemise Camisas de los cilindros втулка цилиндра	PISTON + RINGS Kolben + Ringe Piston + Segments Pistón Set Поршень и кольца			PISTON SET Kolben Set Set de Piston Pistón Set поршень	RINGS SET Kolben Set Segments de Piston Anillos Set кольца	PIN Pin Axe Perno Пин
<b>J4C/J4D/J4J/J4L J4M/J4N/J4P/ J4Q J4R/J4S/J4T JBD/JJA~M2</b> 4 Cyl 73.97 mm Bore Ø 1,297 cc 1,299 cc		Length:		Length:	53.9	Top: 1.5 2nd: 1.75 3rd: 3.0 1st oil: 3.0 2nd oil:	Ø: 18.0 Length: 64.0	
		Outside Ø:		Comp:	29.4			
		Flange Ø:		Height:	0			
		flange depth						
		Reference no.:		Reference no.:		Reference no.:		O-RING
				A-23513 K-92396604 M-0145300 M-0145310 N-8778500000	89BM-6102DA 89BM-6110H2C	A-R43440 G-0878500000 K-800039310000 K-800039340000 M-01453N0		
NM-Germany Article no. Artikelnummer/ Modelo Número / статья НОМЕР	NM-Germany Article no.	NM-Germany Article no.	NM-Germany Article no.	NM-Germany Article no.	NM-Germany Article no.	NM-Germany Article no.	NM-Germany Article no.	
			KBSFO40260G	KBFO40260G	KRFO40260G			

**GASOLINE**

ENGINE TYPE Motortyp Type de Moteur Tipo de motor Тип двигателя	LINER KIT Liner Kit Kit de Chemise Camisas de los cilindros лайнер комплект	CYL. LINER Zylinderlaufbuchse Chemise Camisas de los cilindros втулка цилиндра	PISTON + RINGS Kolben + Ringe Piston + Segments Pistón Set Поршень и кольца			PISTON SET Kolben Set Set de Piston Pistón Set поршень	RINGS SET Kolben Set Segments de Piston Anillos Set кольца	PIN Pin Axe Perno Пин
<b>J4B/J6A J6B/JBC/JBE</b> 4 Cyl 73.97 mm Bore Ø 1,297 cc 1,299 cc		Length:		Length:	53.9	Top: 1.5 2nd: 1.75 3rd: 3.0 1st oil: 3.0 2nd oil:	Ø: 18.0 Length: 64.0	
		Outside Ø:		Comp:	29.4			
		Flange Ø:		Height:	-3.5			
		flange depth						
		Reference no.:		Reference no.:		Reference no.:		O-RING
				A-24017 K-99419600 M-0145900 M-0145910 N-8778500010	6598838 92BM-6102A1A	A-R43440 G-0878500000 K-800039310000 K-800039340000 M-01453N0		
NM-Germany Article no. Artikelnummer/ Modelo Número / статья НОМЕР	NM-Germany Article no.	NM-Germany Article no.	NM-Germany Article no.	NM-Germany Article no.	NM-Germany Article no.	NM-Germany Article no.	NM-Germany Article no.	
			KBSFO40261G	KBFO40261G	KRFO40261G			

**DIESEL**

ENGINE TYPE Motortyp Type de Moteur Tipo de motor Тип двигателя	LINER KIT Liner Kit Kit de Chemise Camisas de los cilindros лайнер комплект	CYL. LINER Zylinderlaufbuchse Chemise Camisas de los cilindros втулка цилиндра	PISTON + RINGS Kolben + Ringe Piston + Segments Pistón Set Поршень и кольца			PISTON SET Kolben Set Set de Piston Pistón Set поршень	RINGS SET Kolben Set Segments de Piston Anillos Set кольца	PIN Pin Axe Perno Пин
<b>HDDA/Hddb HHDA/HHDB</b> 4 Cyl 75.0 mm Bore Ø 1,560 cc	(A) consists of (C)  (B) consists of (D)	(C)	(D)			Top: 3.0 double keystone 2nd: 2.0 3rd: 2.5 1st oil: 2.5 2nd oil:	Ø: 26.0 Length: 61.0	
		Length:	146.0	146.0	Length:			65.3
		Outside Ø:	78.0	78.0	Comp:			41.7
		Flange Ø:		79.0	Height:	-6.0		
		flange depth		4.0	-13.2			
		Reference no.:		Reference no.:		Reference no.:		O-RING
		(C)	(D)			G-0842400000 K-800054940000 M-04006N0		
				A-A354125 K-40179600 M-0400600 N-8742400000				
NM-Germany Article no. Artikelnummer/ Modelo Número / статья НОМЕР	NM-Germany Article no.	NM-Germany Article no.	NM-Germany Article no.	NM-Germany Article no.	NM-Germany Article no.	NM-Germany Article no.	NM-Germany Article no.	
	LBSFI40262DPB (A) LBSFI40262DSB (B)	LBF140262DPB (C) LBF140262DSB (D)	FI40262DBKBS	KBFI40262G	KRFI40262GB			



**GASOLINE**

ENGINE TYPE Motortyp Type de Moteur Tipo de motor Тип двигателя	LINER KIT Liner Kit Kit de Chemise Camisas de los cilindros лайнер комплект	CYL. LINER Zylinderlaufbuchse Chemise Camisas de los cilindros втулка цилиндра	PISTON + RINGS Kolben + Ringe Piston + Segments Pistón Set Поршень и кольца			PISTON SET Kolben Set Set de Piston Pistón Set поршневой	RINGS SET Kolben Set Segments de Piston Anillos Set кольца	PIN Pin Axe Perno Пин		
<b>L1E/L1F/L1G L1H/L1J/L1K/L1L L1N/L1Q/LUH/ LUJ</b> 4 Cyl 76.0 mm Bore Ø 1,597 cc		Length: Outside Ø: Flange Ø: flange depth	Length:	58.0	Comp: 32.5	Height: 1.75	Top:	1.5	Ø: 20.63 Length: 63.4	
							2nd:	1.6		
							3rd:	1.6		
							1st oil:	2.5		
			Reference no.:	Reference no.:	Reference no.:	Reference no.:	O-RING			
				<b>A-23983 K-94916600 M-0158800 N-8778630000</b>			<b>A-R46060 G-0879630000 K-800043741000 M-01573N0</b>			
NM-Germany Article no. Artikelnummer/ Modelo Número / статья НОМЕР	NM-Germany Article no.	NM-Germany Article no.	NM-Germany Article no.	NM-Germany Article no.	NM-Germany Article no.	NM-Germany Article no.	NM-Germany Article no.			
			<b>KBSFO40263G</b>	<b>KBFO40263G</b>	<b>KRFO40263G</b>					



ENGINE TYPE Motortyp Type de Moteur Tipo de motor Тип двигателя	LINER KIT Liner Kit Kit de Chemise Camisas de los cilindros лайнер комплект	CYL. LINER Zylinderlaufbuchse Chemise Camisas de los cilindros втулка цилиндра	PISTON + RINGS Kolben + Ringe Piston + Segments Pistón Set Поршень и кольца			PISTON SET Kolben Set Set de Piston Pistón Set поршневой	RINGS SET Kolben Set Segments de Piston Anillos Set кольца	PIN Pin Axe Perno Пин		
<b>FXDA/FXDB FXDC/FXDD FXJA/FXJB</b> 4 Cyl 76.0 mm Bore Ø 1,388 cc		Length: Outside Ø: Flange Ø: flange depth	Length:	54.25	Comp: 28.25	Height: 1.22	Top:	1.2	Ø: 19.0 Length: 47.0	
							2nd:	1.5		
							3rd:	1.5		
							1st oil:	2.5		
			Reference no.:	Reference no.:	Reference no.:	Reference no.:	O-RING			
				<b>K-40032600</b>			<b>A-R49760 G-0810230000 K-800054240000 M-01503N0</b>			
NM-Germany Article no. Artikelnummer/ Modelo Número / статья НОМЕР	NM-Germany Article no.	NM-Germany Article no.	NM-Germany Article no.	NM-Germany Article no.	NM-Germany Article no.	NM-Germany Article no.	NM-Germany Article no.			
			<b>KBSFO40264G</b>	<b>KBFO40264G</b>	<b>KRFO40264G</b>					

ENGINE TYPE Motortyp Type de Moteur Tipo de motor Тип двигателя	LINER KIT Liner Kit Kit de Chemise Camisas de los cilindros лайнер комплект	CYL. LINER Zylinderlaufbuchse Chemise Camisas de los cilindros втулка цилиндра	PISTON + RINGS Kolben + Ringe Piston + Segments Pistón Set Поршень и кольца			PISTON SET Kolben Set Set de Piston Pistón Set поршневой	RINGS SET Kolben Set Segments de Piston Anillos Set кольца	PIN Pin Axe Perno Пин		
<b>FHD FHF</b> 4 Cyl 76.0 mm Bore Ø 1,388 cc		Length: Outside Ø: Flange Ø: flange depth	Length:	50.8	Comp: 28.3	Height: -1.0	Top:	1.2	Ø: 19.0 Length: 57.0	
							2nd:	1.5		
							3rd:	1.5		
							1st oil:	2.5		
			Reference no.:	Reference no.:	Reference no.:	Reference no.:	O-RING			
							<b>A-R49760 G-0810230000 K-800054240000 M-01503N0</b>			
NM-Germany Article no. Artikelnummer/ Modelo Número / статья НОМЕР	NM-Germany Article no.	NM-Germany Article no.	NM-Germany Article no.	NM-Germany Article no.	NM-Germany Article no.	NM-Germany Article no.	NM-Germany Article no.			
			<b>KBSFO40265G</b>	<b>KBFO40265G</b>	<b>KRFO40265G</b>					

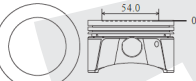

**GASOLINE**

ENGINE TYPE Motortyp Type de Moteur Tipo de motor Тип двигателя	LINER KIT Liner Kit Kit de Chemise Camisas de los cilindros лайнер комплект	CYL. LINER Zylinderlaufbuchse Chemise Camisas de los cilindros втулка цилиндра	PISTON + RINGS Kolben + Ringe Piston + Segments Pistón Set Поршень и кольца			PISTON SET Kolben Set Set de Piston Pistón Set поршень	RINGS SET Kolben Set Segments de Piston Anillos Set кольца	PIN Pin Axe Perno Пин
<b>CVH FUA</b> 4 Cyl 77.25 mm Bore Ø 1,396 cc		Length: Outside Ø: Flange Ø: flange depth	Length: Comp: Height:	75.6 39.3 6.3	skirt MOS2 treated	Top: 1.6	Ø: 20.63 Length: 63.5	
						2nd: 2.0		
						3rd: 4.0		
			Reference no.:	Reference no.:	Reference no.:	Reference no.:	O-RING	
				<b>A-22010</b> <b>K-93828604</b> <b>M-0131800</b>	<b>6153159</b> <b>6153161</b> <b>6153163</b> <b>86SM-6102AA</b> <b>86SM-6102AB</b> <b>86SM-6102KA</b> <b>86SM-6102MA</b>	<b>6153165</b> <b>6153166</b> <b>6153167</b> <b>86SM-6148AA</b> <b>86SM-6148BA</b> <b>86SM-6148CA</b> <b>A-R42330</b> <b>G-0878110000</b> <b>K-800008140000</b> <b>M-01317N0</b>		
NM-Germany Article no. Artikelnummer/ Modelo Número / статья НОМЕР	NM-Germany Article no.	NM-Germany Article no.	NM-Germany Article no.	NM-Germany Article no.	NM-Germany Article no.	NM-Germany Article no.	NM-Germany Article no.	
			<b>KBSFO40266G</b>	<b>KBFO40266G</b>	<b>KRFO40266G</b>			

**GASOLINE**

ENGINE TYPE Motortyp Type de Moteur Tipo de motor Тип двигателя	LINER KIT Liner Kit Kit de Chemise Camisas de los cilindros лайнер комплект	CYL. LINER Zylinderlaufbuchse Chemise Camisas de los cilindros втулка цилиндра	PISTON + RINGS Kolben + Ringe Piston + Segments Pistón Set Поршень и кольца			PISTON SET Kolben Set Set de Piston Pistón Set поршень	RINGS SET Kolben Set Segments de Piston Anillos Set кольца	PIN Pin Axe Perno Пин
<b>FYDA FYDB</b> 4 Cyl 79.0 mm Bore Ø 1,596 cc		Length: Outside Ø: Flange Ø: flange depth	Length: Comp: Height:	48.1 25.1 -0.7	skirt MOS2 treated	Top: 1.2	Ø: 18.0 Length: 51.0	
						2nd: 1.5		
						3rd: 2.0		
			Reference no.:	Reference no.:	Reference no.:	Reference no.:	O-RING	
				<b>M-79L82</b>		<b>3S6G-6159CA</b> <b>3S6G-6161CA</b> <b>98MM-6150CB</b> <b>98MM-6152CB</b> <b>A-R49770</b> <b>G-0814130000</b> <b>M-01498N0</b>		
NM-Germany Article no. Artikelnummer/ Modelo Número / статья НОМЕР	NM-Germany Article no.	NM-Germany Article no.	NM-Germany Article no.	NM-Germany Article no.	NM-Germany Article no.	NM-Germany Article no.	NM-Germany Article no.	
			<b>KBSFO40267G</b>	<b>KBFO40267G</b>	<b>KRFO40267G</b>			

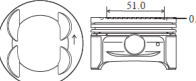
**GASOLINE**

ENGINE TYPE Motortyp Type de Moteur Tipo de motor Тип двигателя	LINER KIT Liner Kit Kit de Chemise Camisas de los cilindros лайнер комплект	CYL. LINER Zylinderlaufbuchse Chemise Camisas de los cilindros втулка цилиндра	PISTON + RINGS Kolben + Ringe Piston + Segments Pistón Set Поршень и кольца			PISTON SET Kolben Set Set de Piston Pistón Set поршень	RINGS SET Kolben Set Segments de Piston Anillos Set кольца	PIN Pin Axe Perno Пин
<b>FYJA FYJB</b> 4 Cyl 79.0 mm Bore Ø 1,596 cc		Length: Outside Ø: Flange Ø: flange depth	Length: Comp: Height:	48.3 25.3 -0.7	skirt MOS2 treated	Top: 1.2	Ø: 18.0 Length: 54.0	
						2nd: 1.5		
						3rd: 2.0		
			Reference no.:	Reference no.:	Reference no.:	Reference no.:	O-RING	
				<b>M-0157600</b>	<b>4M5G-6105EC</b> <b>4M5G-6105ED</b>	<b>3S6G-6159CA</b> <b>3S6G-6161CA</b> <b>98MM-6150CB</b> <b>98MM-6152CB</b> <b>A-R49770</b> <b>G-0814130000</b> <b>M-01498N0</b>		
NM-Germany Article no. Artikelnummer/ Modelo Número / статья НОМЕР	NM-Germany Article no.	NM-Germany Article no.	NM-Germany Article no.	NM-Germany Article no.	NM-Germany Article no.	NM-Germany Article no.	NM-Germany Article no.	
			<b>KBSFO40268G</b>	<b>KBFO40268G</b>	<b>KRFO40268G</b>			

ENGINE TYPE	LINER KIT	CYL. LINER	PISTON + RINGS			PISTON SET	RINGS SET	PIN
Motorotyp Type de Moteur Tipo de motor Тип двигателя	Liner Kit Kit de Chemise Camisas de los cilindros лайнер комплект	Zylinderlaufbuchse Chemise Camisas de los cilindros втулка цилиндра	Kolben + Ringe Piston + Segments Pistón Set Поршень и кольца			Kolben Set Set de Piston Pistón Set поршневой	Kolben Set Segments de Piston Anillos Set кольца	Pin Axe Perno Пин
<b>AFN/AHU TURBO</b> <b>1Z/MF/MG TURBO</b>  4 Cyl 79.5 mm Bore Ø 1,896 cc	<b>K-94427970</b>			STD 0.25	0.50 1.00	alfin top ring land and skirt MOS2 treated pin bushing inserted	Top: 1.75	Ø: 26.0 Length: 66.0
		Length: 152.0	Length: 71.8	71.8	2nd: 2.0			
		Outside Ø: 82.5 Flange Ø: 85.5 flange depth 4.7	Comp: 45.8 Height: -8.8 -17.75	45.55 -8.8 -17.75	3rd: 3.0		1st oil: 3.0 2nd oil:	
		Reference no.:	Reference no.:	Reference no.:	Reference no.:	O-RING		
		<b>A-SU351317</b> <b>G-1402795000</b> <b>K-89434190</b> <b>M-029WV20</b>	<b>K-94427700</b> <b>M-0304000</b> <b>N-8711490095</b>			<b>A-R60370</b> <b>G-0811490000</b> <b>K-800000810000</b> <b>K-800051640000</b> <b>M-03020N0</b>		
NM-Germany Article no. Artikelnummer/ Modelo Número / статья НОМЕР	NM-Germany Article no.	NM-Germany Article no.	NM-Germany Article no.	NM-Germany Article no.	NM-Germany Article no.	NM-Germany Article no.	NM-Germany Article no.	NM-Germany Article no.
	<b>LBSFO40269DSA</b> (for cyl 1/2)	<b>LBFO40269DSA</b>	<b>KBSFO40269DA</b> (for cyl 1/2)	<b>KBFO40269DA</b> (for cyl 1/2)	<b>KBFO40269DA</b> (for cyl 1/2)	<b>KRFO40269DA</b>		

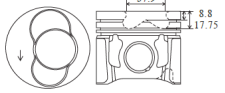

ENGINE TYPE	LINER KIT	CYL. LINER	PISTON + RINGS			PISTON SET	RINGS SET	PIN
Motorotyp Type de Moteur Tipo de motor Тип двигателя	Liner Kit Kit de Chemise Camisas de los cilindros лайнер комплект	Zylinderlaufbuchse Chemise Camisas de los cilindros втулка цилиндра	Kolben + Ringe Piston + Segments Pistón Set Поршень и кольца			Kolben Set Set de Piston Pistón Set поршневой	Kolben Set Segments de Piston Anillos Set кольца	Pin Axe Perno Пин
<b>AFN/AHU TURBO</b> <b>1Z/MF/MG TURBO</b>  4 Cyl 79.5 mm Bore Ø 1,896 cc	<b>K-94428970</b>			STD 0.25	0.50 1.00	alfin top ring land and skirt MOS2 treated pin bushing inserted	Top: 1.75	Ø: 26.0 Length: 66.0
		Length: 152.0	Length: 71.8	71.8	2nd: 2.0			
		Outside Ø: 85.5 Flange Ø: 85.5 flange depth 4.7	Comp: 45.8 Height: -8.8 -17.75	45.55 -8.8 -17.75	3rd: 3.0		1st oil: 3.0 2nd oil:	
		Reference no.:	Reference no.:	Reference no.:	Reference no.:	O-RING		
		<b>A-SU351317</b> <b>G-1402795000</b> <b>K-89434190</b> <b>M-029WV20</b>	<b>K-94428700</b> <b>M-0304100</b> <b>N-8711490090</b>			<b>A-R60370</b> <b>G-0811490000</b> <b>K-800000810000</b> <b>K-800051640000</b> <b>M-03020N0</b>		
NM-Germany Article no. Artikelnummer/ Modelo Número / статья НОМЕР	NM-Germany Article no.	NM-Germany Article no.	NM-Germany Article no.	NM-Germany Article no.	NM-Germany Article no.	NM-Germany Article no.	NM-Germany Article no.	NM-Germany Article no.
	<b>LBSFO40270DSA</b> (for cyl 3/4)	<b>LBFO40270DSA</b>	<b>KBSFO40270DA</b> (for cyl 3/4)	<b>KBFO40270DA</b> (for cyl 3/4)	<b>KBFO40270DA</b> (for cyl 3/4)	<b>KRFO40270DA</b>		

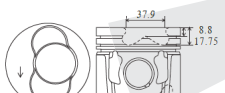



FORD



ENGINE TYPE	LINER KIT	CYL. LINER	PISTON + RINGS			PISTON SET	RINGS SET	PIN
Motorotyp Type de Moteur Tipo de motor Тип двигателя	Liner Kit Kit de Chemise Camisas de los cilindros лайнер комплект	Zylinderlaufbuchse Chemise Camisas de los cilindros втулка цилиндра	Kolben + Ringe Piston + Segments Pistón Set Поршень и кольца			Kolben Set Set de Piston Pistón Set поршневой	Kolben Set Segments de Piston Anillos Set кольца	Pin Axe Perno Пин
<b>ASZ TURBO</b>  4 Cyl 79.5 mm Bore Ø 1,896 cc				STD	O/S	alfin and with oil gallery skirt MOS2 treated pin bushing inserted fits tapered con. rod	Top: 1.75	Ø: 26.0 Length: 66.0
		Length: 152.0	Length: 69.8	69.55	2nd: 2.0			
		Outside Ø: 85.5 Flange Ø: 85.5 flange depth 4.7	Comp: 45.8 Height: -10.3 -17.5	45.55 -10.3 -17.5	3rd: 3.0		1st oil: 3.0 2nd oil:	
		Reference no.:	Reference no.:	Reference no.:	Reference no.:	O-RING		
		<b>A-SU351317</b> <b>G-1402795000</b> <b>K-89434190</b> <b>M-029WV20</b>	<b>K-99470600</b> <b>M-0308600</b> <b>N-8711490045</b>			<b>A-R60370</b> <b>G-0811490000</b> <b>K-800000810000</b> <b>K-800051640000</b> <b>M-03020N0</b>		
NM-Germany Article no. Artikelnummer/ Modelo Número / статья НОМЕР	NM-Germany Article no.	NM-Germany Article no.	NM-Germany Article no.	NM-Germany Article no.	NM-Germany Article no.	NM-Germany Article no.	NM-Germany Article no.	NM-Germany Article no.
	<b>LBSFO40271DSB</b> (for cyl 1/2)	<b>LBFO40271DSB</b>	<b>KBSFO40271DB</b> (for cyl 1/2)	<b>KBFO40271DB</b> (for cyl 1/2)	<b>KBFO40271DB</b> (for cyl 1/2)	<b>KRFO40271DB</b>		

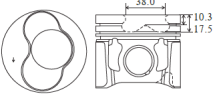

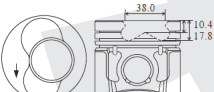

**DIESEL**

ENGINE TYPE	LINER KIT	CYL. LINER	PISTON + RINGS		PISTON SET	RINGS SET	PIN
Motortyp Type de Moteur Tipo de motor Тип двигателя	Liner Kit Kit de Chemise Camisas de los cilindros лайнер комплект	Zylinderlaufbuchse Chemise Camisas de los cilindros втулка цилиндра	Kolben + Ringe Piston + Segments Pistón Set Поршень и кольца		Kolben Set Set de Piston Pistón Set поршеньой	Kolben Set Segments de Piston Anillos Set кольца	Pin Axe Perno Пин
<b>ASZ TURBO</b> 4 Cyl 79.5 mm Bore Ø 1,896 cc		Length: 152.0 Outside Ø: 82.5 Flange Ø: 85.5 flange depth 4.7	Length: 69.8 Comp: 45.8 Height: -17.5	STD 69.55 O/S 45.55 -17.5	alfin and with oil gallery skirt MOS2 treated pin bushing inserted fits tapered con. rod	Top: 1.75 2nd: 2.0 3rd: 3.0 1st oil: 2nd oil:	Ø: 26.0 Length: 66.0
		Reference no.:	Reference no.:	Reference no.:	Reference no.:	O-RING	
		<b>A-SU351317</b> <b>G-1402795000</b> <b>K-89434190</b> <b>M-029WV20</b>	<b>K-99471600</b> <b>M-0308700</b> <b>N-8711490046</b>		<b>A-R60370</b> <b>G-0811490000</b> <b>K-80000810000</b> <b>K-800051640000</b> <b>M-03020N0</b>		
NM-Germany Article no. Artikelnummer/ Modelo Número / статья НОМЕР	NM-Germany Article no.	NM-Germany Article no.	NM-Germany Article no.	NM-Germany Article no.	NM-Germany Article no.	NM-Germany Article no.	NM-Germany Article no.
	LBSFO40272DSB (for cyl 3/4)	LBFO40272DSB	KBSFO40272DB (for cyl 3/4)	KBFO40272DB (for cyl 3/4)	KRFO40272DB		



**DIESEL**

ENGINE TYPE	LINER KIT	CYL. LINER	PISTON + RINGS		PISTON SET	RINGS SET	PIN
Motortyp Type de Moteur Tipo de motor Тип двигателя	Liner Kit Kit de Chemise Camisas de los cilindros лайнер комплект	Zylinderlaufbuchse Chemise Camisas de los cilindros втулка цилиндра	Kolben + Ringe Piston + Segments Pistón Set Поршень и кольца		Kolben Set Set de Piston Pistón Set поршеньой	Kolben Set Segments de Piston Anillos Set кольца	Pin Axe Perno Пин
<b>AUY TURBO</b> 4 Cyl 79.5 mm Bore Ø 1,896 cc		Length: 152.0 Outside Ø: 82.5 Flange Ø: 85.5 flange depth 4.7	Length: 69.8 Comp: 45.8 Height: -10.4	STD 69.55 O/S 45.55 -10.4 -17.8	alfin and with oil gallery top ring land and skirt MOS2 treated pin bushing inserted fits tapered con. rod	Top: 1.75 2nd: 2.0 3rd: 3.0 1st oil: 2nd oil:	Ø: 26.0 Length: 66.0
		Reference no.:	Reference no.:	Reference no.:	Reference no.:	O-RING	
		<b>A-SU351317</b> <b>G-1402795000</b> <b>K-89434190</b> <b>M-029WV20</b>	<b>K-99842600</b> <b>M-0305600</b> <b>N-8711490005</b>		<b>A-R60370</b> <b>G-0811490000</b> <b>K-80000810000</b> <b>K-800051640000</b> <b>M-03020N0</b>		
NM-Germany Article no. Artikelnummer/ Modelo Número / статья НОМЕР	NM-Germany Article no.	NM-Germany Article no.	NM-Germany Article no.	NM-Germany Article no.	NM-Germany Article no.	NM-Germany Article no.	NM-Germany Article no.
	LBSFO40273DSB (for cyl 1/2)	LBFO40273DSB	KBSFO40273DB (for cyl 1/2)	KBFO40273DB (for cyl 1/2)	KRFO40273DB		

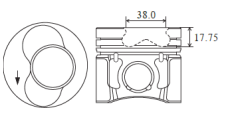

**DIESEL**

ENGINE TYPE	LINER KIT	CYL. LINER	PISTON + RINGS		PISTON SET	RINGS SET	PIN
Motortyp Type de Moteur Tipo de motor Тип двигателя	Liner Kit Kit de Chemise Camisas de los cilindros лайнер комплект	Zylinderlaufbuchse Chemise Camisas de los cilindros втулка цилиндра	Kolben + Ringe Piston + Segments Pistón Set Поршень и кольца		Kolben Set Set de Piston Pistón Set поршеньой	Kolben Set Segments de Piston Anillos Set кольца	Pin Axe Perno Пин
<b>AUY TURBO</b> 4 Cyl 79.5 mm Bore Ø 1,896 cc		Length: 152.0 Outside Ø: 82.5 Flange Ø: 85.5 flange depth 4.7	Length: 69.8 Comp: 45.8 Height: -10.4	STD 69.55 O/S 45.55 -10.4 -17.8	alfin and with oil gallery top ring land and skirt MOS2 treated pin bushing inserted fits tapered con. rod	Top: 1.75 2nd: 2.0 3rd: 3.0 1st oil: 2nd oil:	Ø: 26.0 Length: 66.0
		Reference no.:	Reference no.:	Reference no.:	Reference no.:	O-RING	
		<b>A-SU351317</b> <b>G-1402795000</b> <b>K-89434190</b> <b>M-029WV20</b>	<b>K-99843600</b> <b>M-0305700</b> <b>N-8711490015</b>		<b>A-R60370</b> <b>G-0811490000</b> <b>K-80000810000</b> <b>K-800051640000</b> <b>M-03020N0</b>		
NM-Germany Article no. Artikelnummer/ Modelo Número / статья НОМЕР	NM-Germany Article no.	NM-Germany Article no.	NM-Germany Article no.	NM-Germany Article no.	NM-Germany Article no.	NM-Germany Article no.	NM-Germany Article no.
	LBSFO40274DSB (for cyl 3/4)	LBFO40274DSB	KBSFO40274DB (for cyl 3/4)	KBFO40274DB (for cyl 3/4)	KRFO40274DB		

**DIESEL**

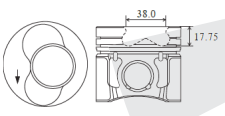

ENGINE TYPE	LINER KIT	CYL. LINER	PISTON + RINGS		PISTON SET	RINGS SET	PIN
Motor typ Type de Moteur Tipo de motor Тип двигателя	Liner Kit Kit de Chemise Camisas de los cilindros лайнер комплект	Zylinderlaufbuchse Chemise Camisas de los cilindros втулка цилиндра		STD O/S	Kolben Set Set de Piston Pistón Set поршеньной	Kolben Set Segments de Piston Anillos Set кольца	Pin Axe Perno Пин
<b>ANU</b> 4 Cyl 79.5 mm Bore Ø 1,896 cc		Length: 152.0 Outside Ø: 82.5 Flange Ø: 85.5 flange depth 4.7	Length: 69.8 Comp: 45.8 Height: -17.75	69.55 45.55 -17.75	alfin and with oil gallery skirt MOS2 treated pin bushing inserted fits tapered con. rod	Top: 1.75 2nd: 2.0 3rd: 3.0 1st oil: 2nd oil:	Ø: 26.0 Length: 66.0
							
		Reference no.:	Reference no.:	Reference no.:	Reference no.:	O-RING	
		<b>A-SU351317</b> <b>G-1402795000</b> <b>K-89434190</b> <b>M-029WV20</b>	<b>K-99850600</b> <b>M-0306500</b>			<b>A-R60370</b> <b>G-0811490000</b> <b>K-800000810000</b> <b>K-800051640000</b> <b>M-03020N0</b>	
NM-Germany Article no. Artikelnummer/ Modelo Número / статья НОМЕР	NM-Germany Article no.	NM-Germany Article no.	NM-Germany Article no.	NM-Germany Article no.	NM-Germany Article no.	NM-Germany Article no.	NM-Germany Article no.
	<b>LBSFO40275DSB</b> (for cyl 1/2)	<b>LBFO40275DSB</b>	<b>KBSFO40275DB</b> (for cyl 1/2)	<b>KBFO40275DB</b> (for cyl 1/2)		<b>KRFO40275DB</b>	

**DIESEL**

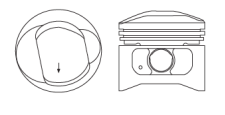

ENGINE TYPE	LINER KIT	CYL. LINER	PISTON + RINGS		PISTON SET	RINGS SET	PIN
Motor typ Type de Moteur Tipo de motor Тип двигателя	Liner Kit Kit de Chemise Camisas de los cilindros лайнер комплект	Zylinderlaufbuchse Chemise Camisas de los cilindros втулка цилиндра		STD O/S	Kolben Set Set de Piston Pistón Set поршеньной	Kolben Set Segments de Piston Anillos Set кольца	Pin Axe Perno Пин
<b>ANU</b> 4 Cyl 79.5 mm Bore Ø 1,896 cc		Length: 152.0 Outside Ø: 82.5 Flange Ø: 85.5 flange depth 4.7	Length: 69.8 Comp: 45.8 Height: -17.75	69.55 45.55 -17.75	alfin and with oil gallery skirt MOS2 treated pin bushing inserted fits tapered con. rod	Top: 1.75 2nd: 2.0 3rd: 3.0 1st oil: 2nd oil:	Ø: 26.0 Length: 66.0
							
		Reference no.:	Reference no.:	Reference no.:	Reference no.:	O-RING	
		<b>A-SU351317</b> <b>G-1402795000</b> <b>K-89434190</b> <b>M-029WV20</b>	<b>K-99851600</b> <b>M-0306600</b>			<b>A-R60370</b> <b>G-0811490000</b> <b>K-800000810000</b> <b>K-800051640000</b> <b>M-03020N0</b>	
NM-Germany Article no. Artikelnummer/ Modelo Número / статья НОМЕР	NM-Germany Article no.	NM-Germany Article no.	NM-Germany Article no.	NM-Germany Article no.	NM-Germany Article no.	NM-Germany Article no.	NM-Germany Article no.
	<b>LBSFO40276DSB</b> (for cyl 3/4)	<b>LBFO40276DSB</b>	<b>KBSFO40276DB</b> (for cyl 3/4)	<b>KBFO40276DB</b> (for cyl 3/4)		<b>KRFO40276DB</b>	

FORD



**GASOLINE**

ENGINE TYPE	LINER KIT	CYL. LINER	PISTON + RINGS		PISTON SET	RINGS SET	PIN
Motor typ Type de Moteur Tipo de motor Тип двигателя	Liner Kit Kit de Chemise Camisas de los cilindros лайнер комплект	Zylinderlaufbuchse Chemise Camisas de los cilindros втулка цилиндра			Kolben Set Set de Piston Pistón Set поршеньной	Kolben Set Segments de Piston Anillos Set кольца	Pin Axe Perno Пин
<b>CVH/HC IPC/ JPA/JPC</b> 4 Cyl 80.0 mm Bore Ø 1,298 cc		Length: 77.7 Outside Ø: 36.26 Flange Ø: +11.6 flange depth	Length: 77.7 Comp: 36.26 Height: +11.6			Top: 1.6 2nd: 2.0 3rd: 4.0 1st oil: 2nd oil:	Ø: 20.63 Length: 67.0
							
		Reference no.:	Reference no.:	Reference no.:	Reference no.:	O-RING	
			<b>K-93362604</b> <b>M-0133700</b>	<b>81SM-6110D1E</b> <b>81SM-6110D2E</b>	<b>81SM-6148BA</b> <b>A-R33716</b> <b>K-800008341000</b> <b>M-01337N0</b> <b>G-0821410000</b>		
NM-Germany Article no. Artikelnummer/ Modelo Número / статья НОМЕР	NM-Germany Article no.	NM-Germany Article no.	NM-Germany Article no.	NM-Germany Article no.	NM-Germany Article no.	NM-Germany Article no.	NM-Germany Article no.
			<b>KBSFO40277G</b>	<b>KBFO40277G</b>		<b>KRFO40277G</b>	



**GASOLINE**

ENGINE TYPE Motortyp Type de Moteur Tipo de motor Тип двигателя	LINER KIT Liner Kit Kit de Chemise Camisas de los cilindros лайнер комплект	CYL. LINER Zylinderlaufbuchse Chemise Camisas de los cilindros втулка цилиндра	PISTON + RINGS Kolben + Ringe Piston + Segments Pistón Set Поршень и кольца			PISTON SET Kolben Set Set de Piston Pistón Set поршневой	RINGS SET Kolben Set Segments de Piston Anillos Set кольца	PIN Pin Axe Perno Пин
<b>CVH/EFI/LJB/ LR1 LR2/LRA/ LUA/LUB</b> 4 Cyl 80.0 mm Bore Ø 1,597 cc  		Length:		Length:	78.0	Top: 1.6 2nd: 2.0 3rd: 1st oil: 4.0 2nd oil:	Ø: 20.63  Length: 67.0	
		Outside Ø:		Comp:	37.5			
		Flange Ø:		Height:	10.7			
		flange depth						
		Reference no.:		Reference no.:		Reference no.:		O-RING
				A-20760 K-93363604 M-0133800	81SM-6102DA 81SM-6102HA 81SM-6102MA 81SM-6110F1D 81SM-6100F2D 86SM-6100D2A	81SM-6148BA A-R33716 K-800008341000 M-01337N0 G-0821410000		
NM-Germany Article no. Artikelnummer/ Modelo Número / статья НОМЕР	NM-Germany Article no.	NM-Germany Article no.	NM-Germany Article no.	NM-Germany Article no.	NM-Germany Article no.	NM-Germany Article no.	NM-Germany Article no.	
			KBSFO40278G	KBFO40278G	KRFO40278G			

**GASOLINE**

ENGINE TYPE Motortyp Type de Moteur Tipo de motor Тип двигателя	LINER KIT Liner Kit Kit de Chemise Camisas de los cilindros лайнер комплект	CYL. LINER Zylinderlaufbuchse Chemise Camisas de los cilindros втулка цилиндра	PISTON + RINGS Kolben + Ringe Piston + Segments Pistón Set Поршень и кольца			PISTON SET Kolben Set Set de Piston Pistón Set поршневой	RINGS SET Kolben Set Segments de Piston Anillos Set кольца	PIN Pin Axe Perno Пин
<b>CVH LUC LUV</b> 4 Cyl 80.0 mm Bore Ø 1,599 cc  		Length:		Length:	74.8	Top: 1.6 2nd: 2.0 3rd: 1st oil: 4.0 2nd oil:	Ø: 20.63  Length: 67.0	
		Outside Ø:		Comp:	36.5			
		Flange Ø:		Height:	8.2			
		flange depth						
		Reference no.:		Reference no.:		Reference no.:		O-RING
				H-21893 K-90204600 M-0136100	86SM-6102BA 86SM-6102BB 86SM-6102LA 86SM-6102NA	81SM-6148BA A-R33716 K-800008341000 M-01337N0 G-0821410000		
NM-Germany Article no. Artikelnummer/ Modelo Número / статья НОМЕР	NM-Germany Article no.	NM-Germany Article no.	NM-Germany Article no.	NM-Germany Article no.	NM-Germany Article no.	NM-Germany Article no.	NM-Germany Article no.	
			KBSFO40279G	KBFO40279G	KRFO40279G			

**GASOLINE**

ENGINE TYPE Motortyp Type de Moteur Tipo de motor Тип двигателя	LINER KIT Liner Kit Kit de Chemise Camisas de los cilindros лайнер комплект	CYL. LINER Zylinderlaufbuchse Chemise Camisas de los cilindros втулка цилиндра	PISTON + RINGS Kolben + Ringe Piston + Segments Pistón Set Поршень и кольца			PISTON SET Kolben Set Set de Piston Pistón Set поршневой	RINGS SET Kolben Set Segments de Piston Anillos Set кольца	PIN Pin Axe Perno Пин
<b>RDA/RDB/RKA RKB/RKC/RQB/ RQC</b> 4 Cyl 80.6 mm Bore Ø 1,796 cc  		Length:		Length:	57.2	Top: 1.5 2nd: 1.6 3rd: 1st oil: 2.5 2nd oil:	Ø: 20.63  Length: 63.5	
		Outside Ø:		Comp:	33.2			
		Flange Ø:		Height:	+0			
		flange depth						
		Reference no.:		Reference no.:		Reference no.:		O-RING
				H-23984 K-94917600 M-0130200 M-S59520 N-8778650000	958M-6011GA1 968M-6011AA1 M-E59520 M-P9164	A-R46070 G-0878650000 K-800051940000 M-01302N0 M-A59520		
NM-Germany Article no. Artikelnummer/ Modelo Número / статья НОМЕР	NM-Germany Article no.	NM-Germany Article no.	NM-Germany Article no.	NM-Germany Article no.	NM-Germany Article no.	NM-Germany Article no.	NM-Germany Article no.	
			KBSFO40280G	KBFO40280G	KRFO40280G			



**GASOLINE**

ENGINE TYPE Motortyp Type de Moteur Tipo de motor Тип двигателя	LINER KIT Liner Kit Kit de Chemise Camisas de los cilindros лайнер комплект	CYL. LINER Zylinderlaufbuchse Chemise Camisas de los cilindros втулка цилиндра	PISTON + RINGS Kolben + Ringe Piston + Segments Pistón Set Поршень и кольца			PISTON SET Kolben Set Set de Piston Pistón Set поршневой	RINGS SET Kolben Set Segments de Piston Anillos Set кольца	PIN Pin Axe Perno Пин
<b>ZH18N</b> 4 Cyl 80.6 mm Bore Ø 1,796 cc		Length: Outside Ø: Flange Ø: flange depth	Length:	52.2	skirt MOS2 treated	Top:	1.2	Ø: 19.0 Length: 50.0
			Comp:	28.2		2nd:	1.5	
			Height:	-1.3		3rd:	2.5	
			Reference no.:	Reference no.:	Reference no.:	Reference no.:	O-RING	
				<b>A-24628</b>		<b>A-R66680</b> <b>G-0813660000</b>		
NM-Germany Article no. Artikelnummer/ Modelo Número / статья НОМЕР	NM-Germany Article no.	NM-Germany Article no.	NM-Germany Article no.	NM-Germany Article no.	NM-Germany Article no.	NM-Germany Article no.	NM-Germany Article no.	
			<b>KBSFO40281G</b>	<b>KBFO40281G</b>	<b>KRFO40281G</b>			

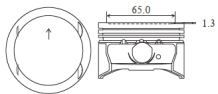

**GASOLINE**

ENGINE TYPE Motortyp Type de Moteur Tipo de motor Тип двигателя	LINER KIT Liner Kit Kit de Chemise Camisas de los cilindros лайнер комплект	CYL. LINER Zylinderlaufbuchse Chemise Camisas de los cilindros втулка цилиндра	PISTON + RINGS Kolben + Ringe Piston + Segments Pistón Set Поршень и кольца			PISTON SET Kolben Set Set de Piston Pistón Set поршневой	RINGS SET Kolben Set Segments de Piston Anillos Set кольца	PIN Pin Axe Perno Пин
<b>2737E</b> <b>2737HC</b> 4 Cyl 80.96 mm Bore Ø 1,599 cc		Length: Outside Ø: Flange Ø: flange depth	Length:	83.8	skirt MOS2 treated	Top:	1.6	Ø: 20.63 Length: 71.2
			Comp:	44.1		2nd:	2.0	
			Height:	-12.8		3rd:	3.95	
			Reference no.:	Reference no.:	Reference no.:	Reference no.:	O-RING	
				<b>H-18649K/V1</b> <b>K-92460600</b> <b>K-97514600</b> <b>M-0146500</b> <b>N-8778060010</b>	<b>711M-6110HC</b>	<b>711M-6149AD</b> <b>711M-6149DD</b> <b>A-R25106</b> <b>M-01463N0</b> <b>G-0878060010</b>		
NM-Germany Article no. Artikelnummer/ Modelo Número / статья НОМЕР	NM-Germany Article no.	NM-Germany Article no.	NM-Germany Article no.	NM-Germany Article no.	NM-Germany Article no.	NM-Germany Article no.	NM-Germany Article no.	
			<b>KBSFO40282G</b>	<b>KBFO40282G</b>	<b>KRFO40282G</b>			





FORD

**GASOLINE**



ENGINE TYPE Motortyp Type de Moteur Tipo de motor Тип двигателя	LINER KIT Liner Kit Kit de Chemise Camisas de los cilindros лайнер комплект	CYL. LINER Zylinderlaufbuchse Chemise Camisas de los cilindros втулка цилиндра	PISTON + RINGS Kolben + Ringe Piston + Segments Pistón Set Поршень и кольца			PISTON SET Kolben Set Set de Piston Pistón Set поршневой	RINGS SET Kolben Set Segments de Piston Anillos Set кольца	PIN Pin Axe Perno Пин
<b>2735E J2/J3/J3D/</b> <b>J3E KL13</b> 4 Cyl 80.96 mm Bore Ø 1,298 cc		Length: Outside Ø: Flange Ø: flange depth	Length:	83.9	skirt MOS2 treated	Top:	1.6	Ø: 20.64 Length: 71.5
			Comp:	44.3		2nd:	2.0	
			Height:	-12.9		3rd:	3.95	
			Reference no.:	Reference no.:	Reference no.:	Reference no.:	O-RING	
				<b>H-18647K/V1</b> <b>K-92458600</b> <b>M-0146300</b>	<b>711M-6110EC</b>	<b>711M-6149AD</b> <b>711M-6149DD</b> <b>A-R25106</b> <b>M-01463N0</b> <b>G-0878060010</b>		
NM-Germany Article no. Artikelnummer/ Modelo Número / статья НОМЕР	NM-Germany Article no.	NM-Germany Article no.	NM-Germany Article no.	NM-Germany Article no.	NM-Germany Article no.	NM-Germany Article no.	NM-Germany Article no.	
			<b>KBSFO40283G</b>	<b>KBFO40283G</b>	<b>KRFO40283G</b>			

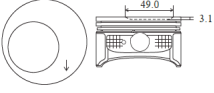

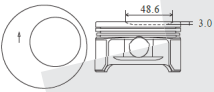

**GASOLINE**

ENGINE TYPE Motortyp Type de Moteur Tipo de motor Тип двигателя	LINER KIT Liner Kit Kit de Chemise Camisas de los cilindros лайнер комплект	CYL. LINER Zylinderlaufbuchse Chemise Camisas de los cilindros втулка цилиндра	PISTON + RINGS Kolben + Ringe Piston + Segments Pistón Set Поршень и кольца	PISTON SET Kolben Set Set de Piston Pistón Set поршневой	RINGS SET Kolben Set Segments de Piston Anillos Set кольца	PIN Pin Axe Perno Пин				
<b>ZL16</b> 4 Cyl 82.07 mm Bore Ø 1,598 cc 		Length: Outside Ø: Flange Ø: flange depth	Length: 48.9 Comp: 24.9 Height: -3.1	head, top and 2nd ring lands anodized skirt MOS2 treated	Top: 1.2 2nd: 1.5 3rd: 2.0 1st oil: 2.0 2nd oil:	Ø: 18.034 Length: 53.5				
					Reference no.:		Reference no.:	Reference no.:	Reference no.:	O-RING
							<b>K-99838600</b>		<b>K-800038440000</b> <b>M-A59840</b>	
NM-Germany Article no. Artikelnummer/ Modelo Número / статья НОМЕР	NM-Germany Article no.	NM-Germany Article no.	NM-Germany Article no.	NM-Germany Article no.	NM-Germany Article no.	NM-Germany Article no.				
			<b>KBSFO40284G</b>	<b>KBFO40284G</b>	<b>KRFO40284G</b>					

**GASOLINE**

ENGINE TYPE Motortyp Type de Moteur Tipo de motor Тип двигателя	LINER KIT Liner Kit Kit de Chemise Camisas de los cilindros лайнер комплект	CYL. LINER Zylinderlaufbuchse Chemise Camisas de los cilindros втулка цилиндра	PISTON + RINGS Kolben + Ringe Piston + Segments Pistón Set Поршень и кольца	PISTON SET Kolben Set Set de Piston Pistón Set поршневой	RINGS SET Kolben Set Segments de Piston Anillos Set кольца	PIN Pin Axe Perno Пин				
<b>ZETEC ROCAM 8V</b> 4 Cyl 82.07 mm Bore Ø 1,598 cc 		Length: Outside Ø: Flange Ø: flange depth	Length: 48.34 Comp: 24.84 Height: -3.0	skirt MOS2 treated	Top: 1.2 2nd: 1.5 3rd: 2.0 1st oil: 2.0 2nd oil:	Ø: 18.03 Length: 52.0				
					Reference no.:		Reference no.:	Reference no.:	Reference no.:	O-RING
							<b>M-S59570</b>	<b>M-E59570</b>	<b>K-800038440000</b> <b>M-A59840</b>	
NM-Germany Article no. Artikelnummer/ Modelo Número / статья НОМЕР	NM-Germany Article no.	NM-Germany Article no.	NM-Germany Article no.	NM-Germany Article no.	NM-Germany Article no.	NM-Germany Article no.				
			<b>KBSFO40285G</b>	<b>KBFO40285G</b>	<b>KRFO40285G</b>					

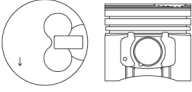
**DIESEL**

ENGINE TYPE Motortyp Type de Moteur Tipo de motor Тип двигателя	LINER KIT Liner Kit Kit de Chemise Camisas de los cilindros лайнер комплект	CYL. LINER Zylinderlaufbuchse Chemise Camisas de los cilindros втулка цилиндра	PISTON + RINGS Kolben + Ringe Piston + Segments Pistón Set Поршень и кольца	PISTON SET Kolben Set Set de Piston Pistón Set поршневой	RINGS SET Kolben Set Segments de Piston Anillos Set кольца	PIN Pin Axe Perno Пин				
<b>RTA/RTB/RTC RTD RTE/RTF RTG/RTH RTJ/ RTK</b> 4 Cyl 82.5 mm Bore Ø 1,753 cc 		Length: Outside Ø: Flange Ø: flange depth	Length: 73.7 Comp: 45.7 Height: -1.3 -2.8	alfin	Top: 2.0 2nd: 2.0 3rd: 3.0 1st oil: 3.0 2nd oil:	Ø: 26.0 Length: 59.0				
					Reference no.:		Reference no.:	Reference no.:	Reference no.:	O-RING
							<b>H-A350979</b> <b>K-91780600</b> <b>M-0136300</b> <b>M-0145500</b>	<b>6184022</b>	<b>A-R43390</b> <b>G-0878350000</b> <b>K-800037040000</b> <b>M-01363N0</b>	
NM-Germany Article no. Artikelnummer/ Modelo Número / статья НОМЕР	NM-Germany Article no.	NM-Germany Article no.	NM-Germany Article no.	NM-Germany Article no.	NM-Germany Article no.	NM-Germany Article no.				
			<b>KBSFO40286DA</b>	<b>KBFO40286DA</b>	<b>KRFO40286DA</b>					

**DIESEL**

ENGINE TYPE Motortyp Type de Moteur Tipo de motor Тип двигателя	LINER KIT Liner Kit Kit de Chemise Camisas de los cilindros лайнер комплект	CYL. LINER Zylinderlaufbuchse Chemise Camisas de los cilindros втулка цилиндра	PISTON + RINGS Kolben + Ringe Piston + Segments Pistón Set Поршень и кольца		PISTON SET Kolben Set Set de Piston Pistón Set поршневой	RINGS SET Kolben Set Segments de Piston Anillos Set кольца	PIN Pin Axe Perno Пин
<b>RFA/RFD TURBO</b> <b>RFN/RFS TURBO</b> <b>RFU/RVA TURBO</b>  4 Cyl 82.5 mm Bore Ø 1,753 cc		Length: Outside Ø: Flange Ø: flange depth	Length: Comp: Height:	75.8 46.65 -1.5 -3.0	alfin skirt MOS2 treated	Top: 2.5 half keystone	Ø: 26.0 Length: 69.0
						2nd: 2.0	
						3rd: 3.0 1st oil: 2nd oil:	
		Reference no.:	Reference no.:	Reference no.:	Reference no.:	O-RING	
			A-A350848 K-91042602 K-93065602 K-94664602 M-0147200 M-0149300	6184026 6792216 89FF-6102AA 89FF-6102EA	A-R60080 G-0810700000 K-800005204000 K-800005514000 M-01493N0 M-01505N0		
NM-Germany Article no. Artikelnummer/ Modelo Número / статья НОМЕР	NM-Germany Article no.	NM-Germany Article no.	NM-Germany Article no.	NM-Germany Article no.	NM-Germany Article no.	NM-Germany Article no.	
			KBSFO40287DA	KBFO40287DA	KRFO40287DA		

ENGINE TYPE Motortyp Type de Moteur Tipo de motor Тип двигателя	LINER KIT Liner Kit Kit de Chemise Camisas de los cilindros лайнер комплект	CYL. LINER Zylinderlaufbuchse Chemise Camisas de los cilindros втулка цилиндра	PISTON + RINGS Kolben + Ringe Piston + Segments Pistón Set Поршень и кольца		PISTON SET Kolben Set Set de Piston Pistón Set поршневой	RINGS SET Kolben Set Segments de Piston Anillos Set кольца	PIN Pin Axe Perno Пин
<b>37.0</b> <b>C9DA</b> <b>C9DB C9DC</b>  4 Cyl 82.5 mm Bore Ø 1,753 cc		Length: Outside Ø: Flange Ø: flange depth	Length: Comp: Height:	70.7 45.7 -4.7 -16.1	alfin skirt MOS2 treated fits tapered con. rod	Top: 2.5 half keystone	Ø: 28.0 Length: 66.0
						2nd: 2.0	
						3rd: 3.0 1st oil: 2nd oil:	
		Reference no.:	Reference no.:	Reference no.:	Reference no.:	O-RING	
			A-A350551 K-40014600 K-99372600 M-0150500 N-8710700000		A-R60080 G-0810700000 K-800005204000 K-800005514000 M-01493N0 M-01505N0		
NM-Germany Article no. Artikelnummer/ Modelo Número / статья НОМЕР	NM-Germany Article no.	NM-Germany Article no.	NM-Germany Article no.	NM-Germany Article no.	NM-Germany Article no.	NM-Germany Article no.	
			KBSFO40288DA	KBFO40288DA	KRFO40288DA		

FORD

ENGINE TYPE Motortyp Type de Moteur Tipo de motor Тип двигателя	LINER KIT Liner Kit Kit de Chemise Camisas de los cilindros лайнер комплект	CYL. LINER Zylinderlaufbuchse Chemise Camisas de los cilindros втулка цилиндра	PISTON + RINGS Kolben + Ringe Piston + Segments Pistón Set Поршень и кольца		PISTON SET Kolben Set Set de Piston Pistón Set поршневой	RINGS SET Kolben Set Segments de Piston Anillos Set кольца	PIN Pin Axe Perno Пин
<b>F9DA</b> <b>F9DB</b>  4 Cyl 82.5 mm Bore Ø 1,753 cc		Length: Outside Ø: Flange Ø: flange depth	Length: Comp: Height:	71.2 45.7 -4.0 -14.0	alfin and with oil gallery skirt MOS2 treated fits tapered con. rod	Top: 2.5 half keystone	Ø: 28.0 Length: 66.0
						2nd: 2.0	
						3rd: 3.0 1st oil: 2nd oil:	
		Reference no.:	Reference no.:	Reference no.:	Reference no.:	O-RING	
			K-99384600 K-99960600 M-0150600		A-R60080 G-0810700000 K-800005204000 K-800005514000 M-01493N0 M-01505N0		
NM-Germany Article no. Artikelnummer/ Modelo Número / статья НОМЕР	NM-Germany Article no.	NM-Germany Article no.	NM-Germany Article no.	NM-Germany Article no.	NM-Germany Article no.	NM-Germany Article no.	
			KBSFO40289DB	KBFO40289DB	KRFO40289DB		

## DIESEL

ENGINE TYPE Motortyp Type de Moteur Tipo de motor Тип двигателя	LINER KIT Liner Kit Kit de Chemise Camisas de los cilindros лайнер комплект	CYL. LINER Zylinderlaufbuchse Chemise Camisas de los cilindros втулка цилиндра	PISTON + RINGS Kolben + Ringe Piston + Segments Pistón Set Поршень и кольца	PISTON SET Kolben Set Set de Piston Pistón Set поршень	RINGS SET Kolben Set Segments de Piston Anillos Set кольца	PIN Pin Axe Perno Пин
<b>KKDA</b> 4 Cyl 82.5 mm Bore Ø 1,753 cc		Length: Outside Ø: Flange Ø: flange depth	Length: 71.2 Comp: 45.7 Height: -5.4 -12.5	alfin and with oil gallery skirt MOS2 treated fits tapered con. rod	Top: 2.5 half keystone 2nd: 2.0 3rd: 1st oil: 3.0 2nd oil:	Ø: 28.0 Length: 66.0
			<b>Reference no.:</b> <b>K-99963600</b>	<b>Reference no.:</b>	<b>Reference no.:</b> <b>A-R60080</b> <b>G-0810700000</b> <b>K-80005204000</b> <b>K-80005514000</b> <b>M-01493N0</b> <b>M-01505N0</b>	<b>O-RING</b>
NM-Germany Article no. Artikelnummer/ Modelo Número / статья НОМЕР	NM-Germany Article no.	NM-Germany Article no.	NM-Germany Article no.	NM-Germany Article no.	NM-Germany Article no.	NM-Germany Article no.
			<b>KBSFO40290DB</b>	<b>KBFO40290DB</b>	<b>KRFO40290DB</b>	

## GASOLINE

ENGINE TYPE Motortyp Type de Moteur Tipo de motor Тип двигателя	LINER KIT Liner Kit Kit de Chemise Camisas de los cilindros лайнер комплект	CYL. LINER Zylinderlaufbuchse Chemise Camisas de los cilindros втулка цилиндра	PISTON + RINGS Kolben + Ringe Piston + Segments Pistón Set Поршень и кольца	PISTON SET Kolben Set Set de Piston Pistón Set поршень	RINGS SET Kolben Set Segments de Piston Anillos Set кольца	PIN Pin Axe Perno Пин
<b>CGBA/CGBB/ CHBA CHBB/ CSDA/CSDB Q7DA/QQDA/ QQDB</b> 4 Cyl 83.0 mm Bore Ø 1,798 cc		Length: Outside Ø: Flange Ø: flange depth	Length: 51.0 Comp: 28.5 Height: 0	top and 2nd ring lands anodized skirt MOS2 treated	Top: 1.2 2nd: 1.2 3rd: 1st oil: 2.5 2nd oil:	Ø: 21.0 Length: 60.0
			<b>Reference no.:</b> <b>K-99456600</b> <b>M-0156800</b>	<b>Reference no.:</b>	<b>Reference no.:</b> <b>K-800044840000</b> <b>M-01568N0</b>	<b>O-RING</b>
NM-Germany Article no. Artikelnummer/ Modelo Número / статья НОМЕР	NM-Germany Article no.	NM-Germany Article no.	NM-Germany Article no.	NM-Germany Article no.	NM-Germany Article no.	NM-Germany Article no.
			<b>KBSFO40291G</b>	<b>KBFO40291G</b>	<b>KRFO40291G</b>	

## GASOLINE

ENGINE TYPE Motortyp Type de Moteur Tipo de motor Тип двигателя	LINER KIT Liner Kit Kit de Chemise Camisas de los cilindros лайнер комплект	CYL. LINER Zylinderlaufbuchse Chemise Camisas de los cilindros втулка цилиндра	PISTON + RINGS Kolben + Ringe Piston + Segments Pistón Set Поршень и кольца	PISTON SET Kolben Set Set de Piston Pistón Set поршень	RINGS SET Kolben Set Segments de Piston Anillos Set кольца	PIN Pin Axe Perno Пин
<b>EAO ZH20</b> 4 Cyl 84.8 mm Bore Ø 1,998 cc		Length: Outside Ø: Flange Ø: flange depth	Length: 57.0 Comp: 33.0 Height: 0		Top: 1.5 2nd: 1.75 3rd: 1st oil: 3.0 2nd oil:	Ø: 20.64 Length: 62.0
			<b>Reference no.:</b> <b>H-24003</b> <b>M-0147300</b>	<b>Reference no.:</b>	<b>Reference no.:</b> <b>A-R48110</b> <b>G-0878640000</b> <b>M-01473N0</b>	<b>O-RING</b>
NM-Germany Article no. Artikelnummer/ Modelo Número / статья НОМЕР	NM-Germany Article no.	NM-Germany Article no.	NM-Germany Article no.	NM-Germany Article no.	NM-Germany Article no.	NM-Germany Article no.
			<b>KBSFO40292G</b>	<b>KBFO40292G</b>	<b>KRFO40292G</b>	

**GASOLINE**

ENGINE TYPE Motortyp Type de Moteur Tipo de motor Тип двигателя	LINER KIT Liner Kit Kit de Chemise Camisas de los cilindros лайнер комплект	CYL. LINER Zylinderlaufbuchse Chemise Camisas de los cilindros втулка цилиндра	PISTON + RINGS Kolben + Ringe Piston + Segments Pistón Set Поршень и кольца		PISTON SET Kolben Set Set de Piston Pistón Set поршневой	RINGS SET Kolben Set Segments de Piston Anillos Set кольца	PIN Pin Axe Perno Пин	
<b>EDDB/EDDC EDDD/EDDF</b> 4 Cyl 84.8 mm Bore Ø 1,988 cc		Length: Outside Ø: Flange Ø: flange depth	Length:	53.4	skirt MOS2 treated	Top:	1.5	Ø: 20.0 Length: 58.0
			Comp:	29.4		2nd:	1.75	
			Height:	0.8		3rd:	3.0	
			Reference no.:	Reference no.:	Reference no.:	Reference no.:	O-RING	
					<b>F8CZ-6108-AA XS7Z-6100-AA</b>	<b>A-R48110 G-0878640000 M-01473N0</b>		
NM-Germany Article no. Artikelnummer/ Modelo Número / статья НОМЕР	NM-Germany Article no.	NM-Germany Article no.	NM-Germany Article no.	NM-Germany Article no.	NM-Germany Article no.	NM-Germany Article no.	NM-Germany Article no.	
			<b>KBSFO40293G</b>	<b>KBFO40293G</b>	<b>KRFO40293G</b>			

ENGINE TYPE Motortyp Type de Moteur Tipo de motor Тип двигателя	LINER KIT Liner Kit Kit de Chemise Camisas de los cilindros лайнер комплект	CYL. LINER Zylinderlaufbuchse Chemise Camisas de los cilindros втулка цилиндра	PISTON + RINGS Kolben + Ringe Piston + Segments Pistón Set Поршень и кольца		PISTON SET Kolben Set Set de Piston Pistón Set поршневой	RINGS SET Kolben Set Segments de Piston Anillos Set кольца	PIN Pin Axe Perno Пин	
<b>CAA/EAO/Sigma Zetec</b> 4 Cyl 84.8 mm Bore Ø 1,998 cc		Length: Outside Ø: Flange Ø: flange depth	Length:	56.9	skirt MOS2 treated	Top:	1.2	Ø: 20.63 Length: 63.5
			Comp:	32.9		2nd:	1.75	
			Height:	0		3rd:	3.0	
			Reference no.:	Reference no.:	Reference no.:	Reference no.:	O-RING	
						<b>M-0130300</b>	<b>M-01303N0</b>	
NM-Germany Article no. Artikelnummer/ Modelo Número / статья НОМЕР	NM-Germany Article no.	NM-Germany Article no.	NM-Germany Article no.	NM-Germany Article no.	NM-Germany Article no.	NM-Germany Article no.	NM-Germany Article no.	
			<b>KBSFO40294G</b>	<b>KBFO40294G</b>	<b>KRFO40294G</b>			

FORD

ENGINE TYPE Motortyp Type de Moteur Tipo de motor Тип двигателя	LINER KIT Liner Kit Kit de Chemise Camisas de los cilindros лайнер комплект	CYL. LINER Zylinderlaufbuchse Chemise Camisas de los cilindros втулка цилиндра	PISTON + RINGS Kolben + Ringe Piston + Segments Pistón Set Поршень и кольца		PISTON SET Kolben Set Set de Piston Pistón Set поршневой	RINGS SET Kolben Set Segments de Piston Anillos Set кольца	PIN Pin Axe Perno Пин	
<b>EDDB/EDDC EDDD/EDDF</b> 4 Cyl 84.8 mm Bore Ø 1,988 cc		Length: Outside Ø: Flange Ø: flange depth	Length:	51.8		Top:	1.5	Ø: 19.0 Length: 55.0
			Comp:	27.8		2nd:	1.5	
			Height:	-1.35		3rd:	3.0	
			Reference no.:	Reference no.:	Reference no.:	Reference no.:	O-RING	
						<b>XS7G-6100-AA</b>		
NM-Germany Article no. Artikelnummer/ Modelo Número / статья НОМЕР	NM-Germany Article no.	NM-Germany Article no.	NM-Germany Article no.	NM-Germany Article no.	NM-Germany Article no.	NM-Germany Article no.	NM-Germany Article no.	
			<b>KBSFO40295G</b>	<b>KBFO40295G</b>	<b>KRFO40295G</b>			

## GASOLINE

ENGINE TYPE Motortyp Type de Moteur Tipo de motor Тип двигателя	LINER KIT Liner Kit Kit de Chemise Camisas de los cilindros лайнер комплект	CYL. LINER Zylinderlaufbuchse Chemise Camisas de los cilindros втулка цилиндра	PISTON + RINGS Kolben + Ringe Piston + Segments Pistón Set Поршень и кольца			PISTON SET Kolben Set Set de Piston Pistón Set поршеньной	RINGS SET Kolben Set Segments de Piston Anillos Set кольца	PIN Pin Axe Perno Пин				
<b>Mondeo 2.0L</b> <b>4 Cyl</b> <b>84.8 mm Bore Ø</b> <b>1,998 cc</b>		Length: 165.0 Outside Ø: 89.06 Flange Ø: 91.0 flange depth 4.5	Length: 52.0 Comp: 28.0 Height: -1.4			Top: 1.5 2nd: 1.75 3rd: 3.0 1st oil: 2nd oil:	Ø: 19.0 Length: 55.0					
								Reference no.:	Reference no.:	Reference no.:	Reference no.:	O-RING
											<b>A-R48110</b> <b>G-0878640000</b> <b>M-01473N0</b>	
NM-Germany Article no. Artikelnummer/ Modelo Número / статья НОМЕР	NM-Germany Article no.	NM-Germany Article no.	NM-Germany Article no.	NM-Germany Article no.	NM-Germany Article no.	NM-Germany Article no.	NM-Germany Article no.					
			<b>KBSFO40296G</b>	<b>KBFO40296G</b>	<b>KRFO40296G</b>							



## DIESEL

ENGINE TYPE Motortyp Type de Moteur Tipo de motor Тип двигателя	LINER KIT Liner Kit Kit de Chemise Camisas de los cilindros лайнер комплект	CYL. LINER Zylinderlaufbuchse Chemise Camisas de los cilindros втулка цилиндра	PISTON + RINGS Kolben + Ringe Piston + Segments Pistón Set Поршень и кольца			PISTON SET Kolben Set Set de Piston Pistón Set поршеньной	RINGS SET Kolben Set Segments de Piston Anillos Set кольца	PIN Pin Axe Perno Пин					
<b>G6DA</b> <b>G6DB</b> <b>4 Cyl</b> <b>85.0 mm Bore Ø</b> <b>1,997 cc</b>	<b>K-99700600</b> <b>A-R60410</b> <b>G-0811470000</b> <b>K-800045940000</b> <b>M-03999N0</b>	Length: 165.0 Outside Ø: 89.06 Flange Ø: 91.0 flange depth 4.5	Length: 80.7 Comp: 46.7 Height: -4.7 -15.4			alfin and with oil gallery skirt MOS2 treated fits tapered con. rod	Top: 3.5 double key-stone 2nd: 2.0 3rd: 3.0 1st oil: 2nd oil:	Ø: 28.0 Length: 70.0					
									Reference no.:	Reference no.:	Reference no.:	Reference no.:	O-RING
NM-Germany Article no. Artikelnummer/ Modelo Número / статья НОМЕР	NM-Germany Article no.	NM-Germany Article no.	NM-Germany Article no.	NM-Germany Article no.	NM-Germany Article no.	NM-Germany Article no.	NM-Germany Article no.						
	<b>LBSFO40297DSB</b>	<b>LBFO40297DSB</b>	<b>KBSFO40297DB</b>	<b>KBFO40297DB</b>	<b>KRFO40297DB</b>								

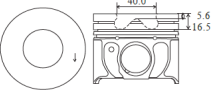

## DIESEL

ENGINE TYPE Motortyp Type de Moteur Tipo de motor Тип двигателя	LINER KIT Liner Kit Kit de Chemise Camisas de los cilindros лайнер комплект	CYL. LINER Zylinderlaufbuchse Chemise Camisas de los cilindros втулка цилиндра	PISTON + RINGS Kolben + Ringe Piston + Segments Pistón Set Поршень и кольца			PISTON SET Kolben Set Set de Piston Pistón Set поршеньной	RINGS SET Kolben Set Segments de Piston Anillos Set кольца	PIN Pin Axe Perno Пин					
<b>PGFA QJBA/B/</b> <b>C/D QVFA/QWFA</b> <b>4 Cyl</b> <b>86.0 mm Bore Ø</b> <b>2,198 cc</b>		Length: 156.0 Outside Ø: 89.0 Flange Ø: 90.9 flange depth 5.0	Length: 69.8 Comp: 43.4 Height: -6.0 -15.8			alfin and with oil gallery skirt MOS2 treated fits tapered con. rod	Top: 2.0 2nd: 2.0 3rd: 2.0 1st oil: 2nd oil:	Ø: 30.0 Length: 66.8					
									Reference no.:	Reference no.:	Reference no.:	Reference no.:	O-RING
									<b>G-1402112000</b>	<b>0628S6</b> <b>1373522</b> <b>M-0160700</b> <b>N-8742770010</b>		<b>A-R67410</b> <b>G-0814080000</b> <b>K-800071540000</b> <b>M-01570N0</b>	
NM-Germany Article no. Artikelnummer/ Modelo Número / статья НОМЕР	NM-Germany Article no.	NM-Germany Article no.	NM-Germany Article no.	NM-Germany Article no.	NM-Germany Article no.	NM-Germany Article no.	NM-Germany Article no.						
	<b>LBSFO40298DFB</b>	<b>LBFO40298DFB</b>	<b>KBSFO40298DB</b>	<b>KBFO40298DB</b>	<b>KRFO40298DB</b>								

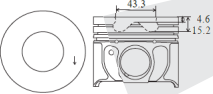

**DIESEL**

ENGINE TYPE Motortyp Type de Moteur Tipo de motor Тип двигателя	LINER KIT Liner Kit Kit de Chemise Camisas de los cilindros лайнер комплект	CYL. LINER Zylinderlaufbuchse Chemise Camisas de los cilindros втулка цилиндра	PISTON + RINGS Kolben + Ringe Piston + Segments Pistón Set Поршень и кольца	PISTON SET Kolben Set Set de Piston Pistón Set поршневой	RINGS SET Kolben Set Segments de Piston Anillos Set кольца	PIN Pin Axe Perno Пин
<b>ABFA D5BA D6BA</b> 4 Cyl 86.0 mm Bore Ø 1,998 cc 		Length: Outside Ø: Flange Ø: flange depth	Length: 74.0 Comp: 47.58 Height: -5.6 -16.5	alfin skirt MOS2 treated	Top: 2.0 2nd: 2.0 3rd: 1st oil: 2.0 2nd oil:	Ø: 30.0 Length: 67.0
		Reference no.:	Reference no.:	Reference no.:	Reference no.:	O-RING
			<b>A-A350591 K-40173600 M-0156900 N-8714080000</b>		<b>A-R67410 G-0814080000 K-800071540000 M-01570N0</b>	
NM-Germany Article no. Artikelnummer/ Modelo Número / статья НОМЕР	NM-Germany Article no.	NM-Germany Article no.	NM-Germany Article no.	NM-Germany Article no.	NM-Germany Article no.	NM-Germany Article no.
			KBSFO40299DA	KBFO40299DA	KRFO40299DA	



**DIESEL**



ENGINE TYPE Motortyp Type de Moteur Tipo de motor Тип двигателя	LINER KIT Liner Kit Kit de Chemise Camisas de los cilindros лайнер комплект	CYL. LINER Zylinderlaufbuchse Chemise Camisas de los cilindros втулка цилиндра	PISTON + RINGS Kolben + Ringe Piston + Segments Pistón Set Поршень и кольца	PISTON SET Kolben Set Set de Piston Pistón Set поршневой	RINGS SET Kolben Set Segments de Piston Anillos Set кольца	PIN Pin Axe Perno Пин
<b>F3FA/FIFA/HJBA HJBB/HJBC/ N7BA</b> 4 Cyl 86.0 mm Bore Ø 1,998 cc 		Length: Outside Ø: Flange Ø: flange depth	Length: 74.1 Comp: 47.7 Height: -4.6 -15.2	alfin and with oil gallery skirt MOS2 treated fits tapered con. rod	Top: 2.0 2nd: 2.0 3rd: 1st oil: 2.0 2nd oil:	Ø: 30.0 Length: 67.0
		Reference no.:	Reference no.:	Reference no.:	Reference no.:	O-RING
			<b>A-A350592 K-40174600 M-0157000 N-8714080010</b>		<b>A-R67410 G-0814080000 K-800071540000 M-01570N0</b>	
NM-Germany Article no. Artikelnummer/ Modelo Número / статья НОМЕР	NM-Germany Article no.	NM-Germany Article no.	NM-Germany Article no.	NM-Germany Article no.	NM-Germany Article no.	NM-Germany Article no.
			KBSFO40300DB	KBFO40300DB	KRFO40300DB	

**DIESEL**

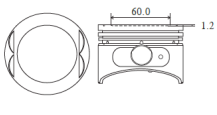

ENGINE TYPE Motortyp Type de Moteur Tipo de motor Тип двигателя	LINER KIT Liner Kit Kit de Chemise Camisas de los cilindros лайнер комплект	CYL. LINER Zylinderlaufbuchse Chemise Camisas de los cilindros втулка цилиндра	PISTON + RINGS Kolben + Ringe Piston + Segments Pistón Set Поршень и кольца	PISTON SET Kolben Set Set de Piston Pistón Set поршневой	RINGS SET Kolben Set Segments de Piston Anillos Set кольца	PIN Pin Axe Perno Пин
<b>RF</b> 4 Cyl 86.0 mm Bore Ø 2,184 cc 		(C) (D) Length: 165.0 165.0 Outside Ø: 89.0 90.0 Flange Ø: 94.0 flange depth 4.0	Length: 86.3 Comp: 47.3 Height: -1.6	alfin	Top: 2.0 2nd: 2.0 3rd: 1st oil: 4.0 2nd oil:	Ø: 25.0 Length: 68.5
		Reference no.:	Reference no.:	Reference no.:	Reference no.:	O-RING
		<b>R201-23-051 RF01-10-311</b>	(E) <b>K-94372700</b> (F) <b>A-A350449 M-6273400 N-8728360000</b>	<b>RF01-23-200 RF01-23-200B</b>	<b>R201-23-130A R201-23-130B A-R42580 G-0828360000 M-62734V0</b>	
NM-Germany Article no. Artikelnummer/ Modelo Número / статья НОМЕР	NM-Germany Article no.	NM-Germany Article no.	NM-Germany Article no.	NM-Germany Article no.	NM-Germany Article no.	NM-Germany Article no.
	<b>LBSFO40301DF LBSFO40301DS LBSFO40301DP LBSFO40301DFA LBSFO40301DSA LBSFO40301DPA</b>	(C) <b>LBFO40301DF LBFO40301DS</b> (D) <b>LBFO40301DP</b>	(E) <b>KBSFO40301DB</b> (F) <b>KBSFO40301DBA</b>	<b>KBFO40301D KBFO40301DA</b>	<b>KRFO40301D</b>	

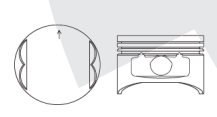
**GASOLINE**

ENGINE TYPE Motortyp Type de Moteur Tipo de motor Тип двигателя	LINER KIT Liner Kit Kit de Chemise Camisas de los cilindros лайнер комплект	CYL. LINER Zylinderlaufbuchse Chemise Camisas de los cilindros втулка цилиндра	PISTON + RINGS Kolben + Ringe Piston + Segments Pistón Set Поршень и кольца		PISTON SET Kolben Set Set de Piston Pistón Set поршневой	RINGS SET Kolben Set Segments de Piston Anillos Set кольца	PIN Pin Axe Perno Пин
<b>N9K/N9L NSD/ NSE/NSF</b> 4 Cyl 86.0 mm Bore Ø 1,998 cc  		Length: Outside Ø: Flange Ø: flange depth	STD	O/S		Top: 1.6 2nd: 1.75 3rd: 1st oil: 3.0 2nd oil:	Ø: 20.63  Length: 63.4
			Length: 62.27	61.97			
			Comp: 32.27	31.97			
		Height: -1.2	-1.2				
		Reference no.:	Reference no.:	Reference no.:	Reference no.:	O-RING	
			<b>K-99380601 M-0156000</b>		<b>A-R47990 G-0878420000 K-800052140000</b>		
NM-Germany Article no. Artikelnummer/ Modelo Número / статья НОМЕР	NM-Germany Article no.	NM-Germany Article no.	NM-Germany Article no.	NM-Germany Article no.	NM-Germany Article no.	NM-Germany Article no.	NM-Germany Article no.
			<b>KBSFO40302G</b>	<b>KBFO40302G</b>	<b>KRFO40302G</b>		

ENGINE TYPE Motortyp Type de Moteur Tipo de motor Тип двигателя	LINER KIT Liner Kit Kit de Chemise Camisas de los cilindros лайнер комплект	CYL. LINER Zylinderlaufbuchse Chemise Camisas de los cilindros втулка цилиндра	PISTON + RINGS Kolben + Ringe Piston + Segments Pistón Set Поршень и кольца		PISTON SET Kolben Set Set de Piston Pistón Set поршневой	RINGS SET Kolben Set Segments de Piston Anillos Set кольца	PIN Pin Axe Perno Пин
<b>N8A/N8B/N8C N8D/N9A/N9B/ N9C N9D/N9E/ N9F/NES</b> 4 Cyl 86.0 mm Bore Ø 1,998 cc  		Length: Outside Ø: Flange Ø: flange depth	STD	O/S		Top: 1.6 2nd: 1.75 3rd: 1st oil: 3.0 2nd oil:	Ø: 20.63  Length: 63.4
			Length: 62.27	61.97			
			Comp: 32.27	31.97			
		Height: -2.2	-2.2				
		Reference no.:	Reference no.:	Reference no.:	Reference no.:	O-RING	
			<b>H-23996 K-90028601 M-0147700 N-8778420000</b>	<b>88WM-6102AA 95WM-6102AA</b>	<b>A-R47990 G-0878420000 K-800052140000</b>		
NM-Germany Article no. Artikelnummer/ Modelo Número / статья НОМЕР	NM-Germany Article no.	NM-Germany Article no.	NM-Germany Article no.	NM-Germany Article no.	NM-Germany Article no.	NM-Germany Article no.	NM-Germany Article no.
			<b>KBSFO40303G</b>	<b>KBFO40303G</b>	<b>KRFO40303G</b>		

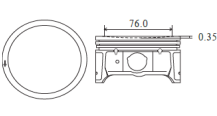
**GASOLINE**

ENGINE TYPE Motortyp Type de Moteur Tipo de motor Тип двигателя	LINER KIT Liner Kit Kit de Chemise Camisas de los cilindros лайнер комплект	CYL. LINER Zylinderlaufbuchse Chemise Camisas de los cilindros втулка цилиндра	PISTON + RINGS Kolben + Ringe Piston + Segments Pistón Set Поршень и кольца		PISTON SET Kolben Set Set de Piston Pistón Set поршневой	RINGS SET Kolben Set Segments de Piston Anillos Set кольца	PIN Pin Axe Perno Пин
<b>AODA/AODB CJBA/CJBB</b> 4 Cyl 87.5 mm Bore Ø 1,999 cc  		Length: Outside Ø: Flange Ø: flange depth	STD	O/S	head, top and 2nd ring lands anodized skirt MOS2 treated	Top: 1.2 2nd: 1.2 3rd: 1st oil: 2.5 2nd oil:	Ø: 21.0  Length: 60.0
			Length: 51.0	51.0			
			Comp: 28.5	28.5			
		Height: -0.35	-0.58				
		Reference no.:	Reference no.:	Reference no.:	Reference no.:	O-RING	
			<b>K-99457600</b>		<b>G-0842340000 K-800044940000 M-01561N0</b>		
NM-Germany Article no. Artikelnummer/ Modelo Número / статья НОМЕР	NM-Germany Article no.	NM-Germany Article no.	NM-Germany Article no.	NM-Germany Article no.	NM-Germany Article no.	NM-Germany Article no.	NM-Germany Article no.
			<b>KBSFO40304G</b>	<b>KBFO40304G</b>	<b>KRFO40304G</b>		



**GASOLINE**



ENGINE TYPE Motortyp Type de Moteur Tipo de motor Тип двигателя	LINER KIT Liner Kit Kit de Chemise Camisas de los cilindros лайнер комплект	CYL. LINER Zylinderlaufbuchse Chemise Camisas de los cilindros втулка цилиндра	PISTON + RINGS Kolben + Ringe Piston + Segments Pistón Set Поршень и кольца			PISTON SET Kolben Set Set de Piston Pistón Set поршневой	RINGS SET Kolben Set Segments de Piston Anillos Set кольца	PIN Pin Axe Perno Пин				
<b>GZ</b> 4 Cyl 87.5 mm Bore Ø 2,261 cc		Length: 51.0 Comp: 28.6 Height: -4.0	Length: 51.0 Comp: 28.6 Height: -4.0	head, top and 2nd ring lands anodized skirt MOS2 treated	Top: 1.2 2nd: 1.2 3rd: 2.5 1st oil: 2nd oil:	Ø: 21.0 Length: 61.5						
								Reference no.:	Reference no.:	Reference no.:	Reference no.:	O-RING
										<b>1L5Z-6009BA</b>	<b>G-0842340000 K-800044940000 M-01561N0</b>	
NM-Germany Article no. Artikelnummer/ Modelo Número / статья НОМЕР	NM-Germany Article no.	NM-Germany Article no.	NM-Germany Article no.	NM-Germany Article no.	NM-Germany Article no.	NM-Germany Article no.	NM-Germany Article no.					
			<b>KBSFO40305G</b>	<b>KBFO40305G</b>	<b>KRFO40305G</b>							

ENGINE TYPE Motortyp Type de Moteur Tipo de motor Тип двигателя	LINER KIT Liner Kit Kit de Chemise Camisas de los cilindros лайнер комплект	CYL. LINER Zylinderlaufbuchse Chemise Camisas de los cilindros втулка цилиндра	PISTON + RINGS Kolben + Ringe Piston + Segments Pistón Set Поршень и кольца			PISTON SET Kolben Set Set de Piston Pistón Set поршневой	RINGS SET Kolben Set Segments de Piston Anillos Set кольца	PIN Pin Axe Perno Пин				
<b>L3</b> 4 Cyl 87.5 mm Bore Ø 2,261 cc		Length: 51.0 Comp: 28.5 Height: -4.0	Length: 51.0 Comp: 28.5 Height: -4.0	head, top and 2nd ring lands anodized skirt MOS2 treated	Top: 1.2 2nd: 1.2 3rd: 2.5 1st oil: 2nd oil:	Ø: 21.0 Length: 60.0						
								Reference no.:	Reference no.:	Reference no.:	Reference no.:	O-RING
											<b>G-0842340000 K-800044940000 M-01561N0</b>	
NM-Germany Article no. Artikelnummer/ Modelo Número / статья НОМЕР	NM-Germany Article no.	NM-Germany Article no.	NM-Germany Article no.	NM-Germany Article no.	NM-Germany Article no.	NM-Germany Article no.	NM-Germany Article no.					
			<b>KBSFO40306G</b>	<b>KBFO40306G</b>	<b>KRFO40306G</b>							

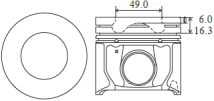

FORD

ENGINE TYPE Motortyp Type de Moteur Tipo de motor Тип двигателя	LINER KIT Liner Kit Kit de Chemise Camisas de los cilindros лайнер комплект	CYL. LINER Zylinderlaufbuchse Chemise Camisas de los cilindros втулка цилиндра	PISTON + RINGS Kolben + Ringe Piston + Segments Pistón Set Поршень и кольца			PISTON SET Kolben Set Set de Piston Pistón Set поршневой	RINGS SET Kolben Set Segments de Piston Anillos Set кольца	PIN Pin Axe Perno Пин				
<b>VTA</b> 4 Cyl 88.0 mm Bore Ø 1,948 cc	<b>M-0395490 K-92791960</b>	Length: 173.1 Outside Ø: 96.0 Flange Ø: 106.3 flange depth 7.0	Length: 95.35 Comp: 58.7 Height: -2.0		Top: 2.0 2nd: 2.0 3rd: 2.0 1st oil: 4.5 2nd oil:	Ø: 28.0 Length: 72.0						
								Reference no.:	Reference no.:	Reference no.:	Reference no.:	O-RING
								<b>M-039WN12 K-88524110</b>	<b>M-0395400 K-92791600</b>		<b>M-03954V0 K-800009240000</b>	<b>ORFO40307D</b>
NM-Germany Article no. Artikelnummer/ Modelo Número / статья НОМЕР	NM-Germany Article no.	NM-Germany Article no.	NM-Germany Article no.	NM-Germany Article no.	NM-Germany Article no.	NM-Germany Article no.	NM-Germany Article no.					
	<b>LBSFO40307DS</b>	<b>LBFO40307DS</b>	<b>KBSFO40307D</b>	<b>KBFO40307D</b>	<b>KRFO40307D</b>							

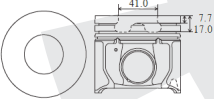

## DIESEL

ENGINE TYPE Motortyp Type de Moteur Tipo de motor Тип двигателя	LINER KIT Liner Kit Kit de Chemise Camisas de los cilindros лайнер комплект	CYL. LINER Zylinderlaufbuchse Chemise Camisas de los cilindros втулка цилиндра	PISTON + RINGS Kolben + Ringe Piston + Segments Pistón Set Поршень и кольца	PISTON SET Kolben Set Set de Piston Pistón Set поршневой	RINGS SET Kolben Set Segments de Piston Anillos Set кольца	PIN Pin Axe Perno Пин
<b>DOFA</b> 4 Cyl 89.9 mm Bore Ø 2,402 cc 		Length:	Length:	alfin skirt MOS2 treated	Top:	Ø: 32.0 Length: 66.0
		Outside Ø:	Comp:		2nd:	
		Flange Ø:	Height:		3rd:	
		flange depth	-16.3		1st oil:	
		Reference no.:	Reference no.:	Reference no.:	Reference no.:	O-RING
			<b>1373531</b>		<b>G-0814810000 K-800051140000 M-01580N0</b>	
NM-Germany Article no. Artikelnummer/ Modelo Número / статья НОМЕР	NM-Germany Article no.	NM-Germany Article no.	NM-Germany Article no.	NM-Germany Article no.	NM-Germany Article no.	NM-Germany Article no.
			<b>KBSFO40308DA</b>	<b>KBFO40308DA</b>	<b>KRFO40308DA</b>	

## DIESEL

ENGINE TYPE Motortyp Type de Moteur Tipo de motor Тип двигателя	LINER KIT Liner Kit Kit de Chemise Camisas de los cilindros лайнер комплект	CYL. LINER Zylinderlaufbuchse Chemise Camisas de los cilindros втулка цилиндра	PISTON + RINGS Kolben + Ringe Piston + Segments Pistón Set Поршень и кольца	PISTON SET Kolben Set Set de Piston Pistón Set поршневой	RINGS SET Kolben Set Segments de Piston Anillos Set кольца	PIN Pin Axe Perno Пин
<b>D2FA F4FA</b> 4 Cyl 89.9 mm Bore Ø 2,402 cc 		Length:	Length:	alfin skirt MOS2 treated fits tapered con. rod	Top:	Ø: 32.0 Length: 66.0
		Outside Ø:	Comp:		2nd:	
		Flange Ø:	Height:		3rd:	
		flange depth	-17.0		1st oil:	
		Reference no.:	Reference no.:	Reference no.:	Reference no.:	O-RING
			<b>1309103 K-40171600 M-0159400</b>		<b>G-0814810000 K-800051140000 M-01580N0</b>	
NM-Germany Article no. Artikelnummer/ Modelo Número / статья НОМЕР	NM-Germany Article no.	NM-Germany Article no.	NM-Germany Article no.	NM-Germany Article no.	NM-Germany Article no.	NM-Germany Article no.
			<b>KBSFO40309DA</b>	<b>KBFO40309DA</b>	<b>KRFO40309DA</b>	

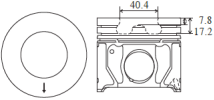
## DIESEL

ENGINE TYPE Motortyp Type de Moteur Tipo de motor Тип двигателя	LINER KIT Liner Kit Kit de Chemise Camisas de los cilindros лайнер комплект	CYL. LINER Zylinderlaufbuchse Chemise Camisas de los cilindros втулка цилиндра	PISTON + RINGS Kolben + Ringe Piston + Segments Pistón Set Поршень и кольца	PISTON SET Kolben Set Set de Piston Pistón Set поршневой	RINGS SET Kolben Set Segments de Piston Anillos Set кольца	PIN Pin Axe Perno Пин
<b>D4FA</b> 4 Cyl 89.9 mm Bore Ø 2,402 cc 		Length:	Length:	alfin and with oil gallery skirt MOS2 treated fits tapered con. rod	Top:	Ø: 32.0 Length: 71.0
		Outside Ø:	Comp:		2nd:	
		Flange Ø:	Height:		3rd:	
		flange depth	-17.2		1st oil:	
		Reference no.:	Reference no.:	Reference no.:	Reference no.:	O-RING
			<b>1369684 A-A354115 K-40172600 M-0158000 N-8714810000</b>		<b>G-0814810000 K-800051140000 M-01580N0</b>	
NM-Germany Article no. Artikelnummer/ Modelo Número / статья НОМЕР	NM-Germany Article no.	NM-Germany Article no.	NM-Germany Article no.	NM-Germany Article no.	NM-Germany Article no.	NM-Germany Article no.
	<b>LBSFO40310DSB</b>	<b>LBFO40310DSB</b>	<b>KBSFO40310DB</b>	<b>KBFO40310DB</b>	<b>KRFO40310DB</b>	

**DIESEL**

ENGINE TYPE Motortyp Type de Moteur Tipo de motor Тип двигателя	LINER KIT Liner Kit Kit de Chemise Camisas de los cilindros лайнер комплект	CYL. LINER Zylinderlaufbuchse Chemise Camisas de los cilindros втулка цилиндра	PISTON + RINGS Kolben + Ringe Piston + Segments Pistón Set Поршень и кольца			PISTON SET Kolben Set Set de Piston Pistón Set поршневой	RINGS SET Kolben Set Segments de Piston Anillos Set кольца	PIN Pin Axe Perno Пин
<b>JXFA PHFA H9FA</b> 4 Cyl 89.9 mm Bore Ø 2,402 cc		Length: Outside Ø: Flange Ø: flange depth	Length:	80.5	alfin and with oil gallery skirt MOS2 treated fits tapered con. rod	Top:	2.0	Ø: 32.0 Length: 71.0
			Comp:	53.5		2nd:	2.0	
			Height:	-7.3		3rd:	2.0	
		Reference no.:	Reference no.:	Reference no.:	Reference no.:	O-RING		
			<b>1369691</b> <b>N-8714810010</b>		<b>G-0814810000</b> <b>K-800051140000</b> <b>M-01580N0</b>			
NM-Germany Article no. Artikelnummer/ Modelo Número / статья НОМЕР	NM-Germany Article no.	NM-Germany Article no.	NM-Germany Article no.	NM-Germany Article no.	NM-Germany Article no.	NM-Germany Article no.	NM-Germany Article no.	
			<b>KBSFO40311DB</b>	<b>KBFO40311DB</b>	<b>KRFO40311DB</b>			

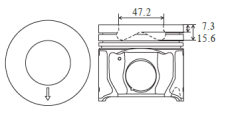

**DIESEL**

ENGINE TYPE Motortyp Type de Moteur Tipo de motor Тип двигателя	LINER KIT Liner Kit Kit de Chemise Camisas de los cilindros лайнер комплект	CYL. LINER Zylinderlaufbuchse Chemise Camisas de los cilindros втулка цилиндра	PISTON + RINGS Kolben + Ringe Piston + Segments Pistón Set Поршень и кольца			PISTON SET Kolben Set Set de Piston Pistón Set поршневой	RINGS SET Kolben Set Segments de Piston Anillos Set кольца	PIN Pin Axe Perno Пин
<b>H9FA H9FB</b> 4 Cyl 89.9 mm Bore Ø 2,402 cc		Length: Outside Ø: Flange Ø: flange depth	Length:	80.5	alfin and with oil gallery skirt MOS2 treated fits tapered con. rod	Top:	2.0	Ø: 32.0 Length: 71.0
			Comp:	53.5		2nd:	2.0	
			Height:	-6.0		3rd:	2.0	
		Reference no.:	Reference no.:	Reference no.:	Reference no.:	O-RING		
			<b>1376491</b> <b>A-A354116</b> <b>N-8714810030</b>		<b>G-0814810000</b> <b>K-800051140000</b> <b>M-01580N0</b>			
NM-Germany Article no. Artikelnummer/ Modelo Número / статья НОМЕР	NM-Germany Article no.	NM-Germany Article no.	NM-Germany Article no.	NM-Germany Article no.	NM-Germany Article no.	NM-Germany Article no.	NM-Germany Article no.	
			<b>KBSFO40312DB</b>	<b>KBFO40312DB</b>	<b>KRFO40312DB</b>			

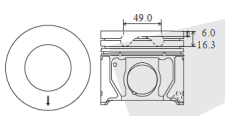

FORD

**GASOLINE**

ENGINE TYPE Motortyp Type de Moteur Tipo de motor Тип двигателя	LINER KIT Liner Kit Kit de Chemise Camisas de los cilindros лайнер комплект	CYL. LINER Zylinderlaufbuchse Chemise Camisas de los cilindros втулка цилиндра	PISTON + RINGS Kolben + Ringe Piston + Segments Pistón Set Поршень и кольца			PISTON SET Kolben Set Set de Piston Pistón Set поршневой	RINGS SET Kolben Set Segments de Piston Anillos Set кольца	PIN Pin Axe Perno Пин
<b>281</b> 8 Cyl 90.2 mm Bore Ø 4,600 cc		Length: Outside Ø: Flange Ø: flange depth	Length:	51.6	skirt MOS2 treated	Top:	1.5	Ø: 22.0 Length: 62.0
			Comp:	30.7		2nd:	1.5	
			Height:	-4.8		3rd:	3.0	
		Reference no.:	Reference no.:	Reference no.:	Reference no.:	O-RING		
				<b>F8AZ-6108BA</b>	<b>2L3Z-6148AA</b> <b>F5LY-6148A</b> <b>F7AZ-6148AA N-SWF30-006</b>			
NM-Germany Article no. Artikelnummer/ Modelo Número / статья НОМЕР	NM-Germany Article no.	NM-Germany Article no.	NM-Germany Article no.	NM-Germany Article no.	NM-Germany Article no.	NM-Germany Article no.	NM-Germany Article no.	
			<b>KBSFO80313G</b>	<b>KBFO80313G</b>	<b>KRFO80313G</b>			

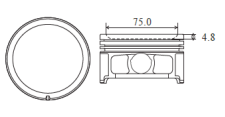

**GASOLINE**

ENGINE TYPE Motortyp Type de Moteur Tipo de motor Тип двигателя	LINER KIT Liner Kit Kit de Chemise Camisas de los cilindros лайнер комплект	CYL. LINER Zylinderlaufbuchse Chemise Camisas de los cilindros втулка цилиндра	PISTON + RINGS Kolben + Ringe Piston + Segments Pistón Set Поршень и кольца		PISTON SET Kolben Set Set de Piston Pistón Set поршневой	RINGS SET Kolben Set Segments de Piston Anillos Set кольца	PIN Pin Axe Perno Пин
<b>KOLN 2V</b> 4 Cyl 90.8 mm Bore Ø 1,994 cc		Length: Outside Ø: Flange Ø: flange depth	Length:	69.7		Top: 1.6 2nd: 2.0 3rd: 2.0 1st oil: 4.0 2nd oil: 4.0	Ø: 24.0 Length: 68.5
			Comp:	41.6			
		Reference no.:	Reference no.:	Reference no.:	Reference no.:	O-RING	
						A-R40230 G-0878030000 K-800009440000 M-01422N0	
NM-Germany Artikelnummer/ Modelo Número / статья HOMEP	NM-Germany Article no.	NM-Germany Article no.	NM-Germany Article no.	NM-Germany Article no.	NM-Germany Article no.	NM-Germany Article no.	NM-Germany Article no.
			KBSFO40314G	KBFO40314G	KRFO40314G		

**GASOLINE**

ENGINE TYPE Motortyp Type de Moteur Tipo de motor Тип двигателя	LINER KIT Liner Kit Kit de Chemise Camisas de los cilindros лайнер комплект	CYL. LINER Zylinderlaufbuchse Chemise Camisas de los cilindros втулка цилиндра	PISTON + RINGS Kolben + Ringe Piston + Segments Pistón Set Поршень и кольца		PISTON SET Kolben Set Set de Piston Pistón Set поршневой	RINGS SET Kolben Set Segments de Piston Anillos Set кольца	PIN Pin Axe Perno Пин
<b>HC/N41/N4A/NE NEL/NEN/NER/ NET NRA/NRB/ NRD/NRI</b> 4 Cyl 90.8 mm Bore Ø 1,994 cc		Length: Outside Ø: Flange Ø: flange depth	Length:	69.5		Top: 1.6 2nd: 2.0 3rd: 2.0 1st oil: 4.0 2nd oil: 4.0	Ø: 24.0 Length: 73.0
			Comp:	41.6			
		Reference no.:	Reference no.:	Reference no.:	Reference no.:	O-RING	
						A-R40230 G-0878030000 K-800009440000 M-01422N0	
NM-Germany Artikelnummer/ Modelo Número / статья HOMEP	NM-Germany Article no.	NM-Germany Article no.	NM-Germany Article no.	NM-Germany Article no.	NM-Germany Article no.	NM-Germany Article no.	NM-Germany Article no.
			KBSFO40315G	KBFO40315G	KRFO40315G		

**DIESEL**

ENGINE TYPE Motortyp Type de Moteur Tipo de motor Тип двигателя	LINER KIT Liner Kit Kit de Chemise Camisas de los cilindros лайнер комплект	CYL. LINER Zylinderlaufbuchse Chemise Camisas de los cilindros втулка цилиндра	PISTON + RINGS Kolben + Ringe Piston + Segments Pistón Set Поршень и кольца		PISTON SET Kolben Set Set de Piston Pistón Set поршневой	RINGS SET Kolben Set Segments de Piston Anillos Set кольца	PIN Pin Axe Perno Пин
<b>SCB/SCC TURBO SCD/VM TURBO</b> 4 Cyl 92.0 mm Bore Ø 2,499 cc	A-ASA2460 K-92286961 K-92286971 M-4891390 N-8911010000	Length: 168.0 Outside Ø: 103.0 Flange Ø: 110.0 flange depth 8.9 +1.2	Length:	86.1	alfin head and top ring land anodized	Top: 2.5 double key- stone 2nd: 2.0 3rd: 2.0 1st oil: 4.0 2nd oil: 4.0	Ø: 30.0 Length: 75.5
			Comp:	51.1			
		Reference no.:	Reference no.:	Reference no.:	Reference no.:	O-RING	
		A-SJ351453 G-1467642000 K-89500110 M-489WN01		K-92286600 K-92286700 M-4891300		A-R47730 G-0811010000 K-80000110000 M-48912N0	
NM-Germany Artikelnummer/ Modelo Número / статья HOMEP	NM-Germany Article no.	NM-Germany Article no.	NM-Germany Article no.	NM-Germany Article no.	NM-Germany Article no.	NM-Germany Article no.	NM-Germany Article no.
	LBSFO40316DFA	LBFO40316DFA	KBSFO40316DA	KBFO40316DA	KRFO40316DA		ORFO40316DA

**GASOLINE**

ENGINE TYPE Motortyp Type de Moteur Tipo de motor Тип двигателя	LINER KIT Liner Kit Kit de Chemise Camisas de los cilindros лайнер комплект	CYL. LINER Zylinderlaufbuchse Chemise Camisas de los cilindros штулка цилиндра	PISTON + RINGS Kolben + Ringe Piston + Segments Pistón Set Поршень и кольца			PISTON SET Kolben Set Set de Piston Pistón Set поршневой	RINGS SET Kolben Set Segments de Piston Anillos Set кольца	PIN Pin Axe Perno Пин
<b>Falcon 4.0L</b> 6 Cyl 92.25 mm Bore Ø 3,984 cc			Length:	56.9		skirt MOS2 treated	Top: 1.2 2nd: 1.5 3rd: 3.0 1st oil: 2nd oil:	Ø: 23.17 Length: 65.0
			Outside Ø:	30.9				
			Flange Ø:	2.0				
			flange depth					
			Reference no.:	Reference no.:	Reference no.:	Reference no.:	O-RING	
							<b>HT-2C4931</b>	
NM-Germany Article no. Artikelnummer/ Modelo Número / статья НОМЕР	NM-Germany Article no.	NM-Germany Article no.	NM-Germany Article no.	NM-Germany Article no.	NM-Germany Article no.	NM-Germany Article no.	NM-Germany Article no.	NM-Germany Article no.
			<b>KBSFO60317G</b>	<b>KBFO60317G</b>	<b>KRFO60317G</b>			

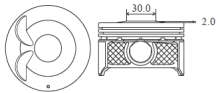

ENGINE TYPE Motortyp Type de Moteur Tipo de motor Тип двигателя	LINER KIT Liner Kit Kit de Chemise Camisas de los cilindros лайнер комплект	CYL. LINER Zylinderlaufbuchse Chemise Camisas de los cilindros штулка цилиндра	PISTON + RINGS Kolben + Ringe Piston + Segments Pistón Set Поршень и кольца			PISTON SET Kolben Set Set de Piston Pistón Set поршневой	RINGS SET Kolben Set Segments de Piston Anillos Set кольца	PIN Pin Axe Perno Пин	
<b>WL-C</b> 4 Cyl 93.0 mm Bore Ø 2,499 cc	(A) consists of (C)  (B) consists of (D)	(C) (D)	Length:	167.5	167.5	81.2	alfin and with oil gallery skirt MOS2 treated	Top: 2.0 2nd: 1.5 3rd: 2.0 1st oil: 2nd oil:	Ø: 34.0 Length: 70.0
			Outside Ø:	96.8	96.8	51.7			
			Flange Ø:	102.2	102.2	-7.1			
			flange depth	2.5 +0.5	2.5 +0.5	-15.2			
			Reference no.:	Reference no.:	Reference no.:	Reference no.:	Reference no.:	O-RING	
			(C) phosphated			<b>1449002</b> <b>1449003</b> <b>1449005</b>	<b>1449009</b> <b>1449010</b> <b>1449011</b>		
NM-Germany Article no. Artikelnummer/ Modelo Número / статья НОМЕР	NM-Germany Article no.	NM-Germany Article no.	NM-Germany Article no.	NM-Germany Article no.	NM-Germany Article no.	NM-Germany Article no.	NM-Germany Article no.	NM-Germany Article no.	NM-Germany Article no.
	<b>LBSFO40318DFB (A)</b> <b>LBSFO40318DFB (B)</b>	<b>LBFO40319DF (C)</b> <b>LBFO40319DS (D)</b>	<b>KBSFO40319DB</b>	<b>KBFO40319DB</b>	<b>KRFO40319D</b>				

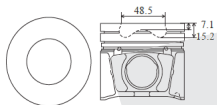

FORD

**DIESEL**

ENGINE TYPE Motortyp Type de Moteur Tipo de motor Тип двигателя	LINER KIT Liner Kit Kit de Chemise Camisas de los cilindros лайнер комплект	CYL. LINER Zylinderlaufbuchse Chemise Camisas de los cilindros штулка цилиндра	PISTON + RINGS Kolben + Ringe Piston + Segments Pistón Set Поршень и кольца			PISTON SET Kolben Set Set de Piston Pistón Set поршневой	RINGS SET Kolben Set Segments de Piston Anillos Set кольца	PIN Pin Axe Perno Пин	
<b>2401 E/4AA</b> <b>2402 E</b> 4/6 Cyl 93.65 mm Bore Ø 2,358 cc 3,537 cc	<b>K-92813961</b>		Length:	171.45		108.1		Top: 2.38 half keystone 2nd: 2.38 3rd: 1st oil: 4.75 2nd oil:	Ø: 29.0 Length: 74.5
			Outside Ø:	96.94		61.6			
			Flange Ø:			-1.0			
			flange depth						
			Reference no.:	Reference no.:	Reference no.:	Reference no.:	Reference no.:	O-RING	
			<b>755F6055A</b> <b>K-89032190 M-</b> <b>014WV04</b>	<b>K-92813600</b> <b>M-0141700</b> <b>N-8720732100</b>	<b>735F-6110-BAA</b> <b>735F-6110-BBA</b> <b>735F-6110-BCA</b>	<b>A-R40120</b> <b>G-0820730010</b> <b>K-800009720000</b> <b>M-01417N0</b>			
NM-Germany Article no. Artikelnummer/ Modelo Número / статья НОМЕР	NM-Germany Article no.	NM-Germany Article no.	NM-Germany Article no.	NM-Germany Article no.	NM-Germany Article no.	NM-Germany Article no.	NM-Germany Article no.	NM-Germany Article no.	NM-Germany Article no.
	<b>LBSFO460319DP</b>	<b>LBFO460319DP</b>	<b>KBSFO460319D</b>	<b>KBFO460319D</b>	<b>KRFO460319D</b>				

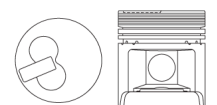

## GASOLINE

ENGINE TYPE Motortyp Type de Moteur Tipo de motor Тип двигателя	LINER KIT Liner Kit Kit de Chemise Camisas de los cilindros лайнер комплект	CYL. LINER Zylinderlaufbuchse Chemise Camisas de los cilindros втулка цилиндра	PISTON + RINGS Kolben + Ringe Piston + Segments Pistón Set Поршень и кольца			PISTON SET Kolben Set Set de Piston Pistón Set поршневой	RINGS SET Kolben Set Segments de Piston Anillos Set кольца	PIN Pin Axe Perno Пин				
<b>ESSEX 3.0 V6</b> 6 Cyl 93.65 mm Bore Ø 2,993 cc		Length: Outside Ø: Flange Ø: flange depth	Length: 95.0 Comp: 46.0 Height: -14.0			Top: 2.0 2nd: 2.0 3rd: 2.0 1st oil: 4.75 2nd oil:	Ø: 22.0 Length: 69.5					
								Reference no.:	Reference no.:	Reference no.:	Reference no.:	O-RING
NM-Germany Article no. Artikelnummer/ Modelo Número / статья НОМЕР	NM-Germany Article no.	NM-Germany Article no.	NM-Germany Article no.	NM-Germany Article no.	NM-Germany Article no.	NM-Germany Article no.	NM-Germany Article no.					
			KBSFO60320G	KBFO60320G	KRFO60320G							

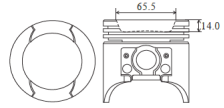

## GASOLINE

ENGINE TYPE Motortyp Type de Moteur Tipo de motor Тип двигателя	LINER KIT Liner Kit Kit de Chemise Camisas de los cilindros лайнер комплект	CYL. LINER Zylinderlaufbuchse Chemise Camisas de los cilindros втулка цилиндра	PISTON + RINGS Kolben + Ringe Piston + Segments Pistón Set Поршень и кольца			PISTON SET Kolben Set Set de Piston Pistón Set поршневой	RINGS SET Kolben Set Segments de Piston Anillos Set кольца	PIN Pin Axe Perno Пин				
<b>ESSEX 3.0 V6</b> 6 Cyl 93.65 mm Bore Ø 2,993 cc		Length: Outside Ø: Flange Ø: flange depth	Length: 95.0 Comp: 46.0 Height: -11.7			Top: 2.0 2nd: 2.0 3rd: 2.0 1st oil: 4.75 2nd oil:	Ø: 22.0 Length: 69.5					
								Reference no.:	Reference no.:	Reference no.:	Reference no.:	O-RING
NM-Germany Article no. Artikelnummer/ Modelo Número / статья НОМЕР	NM-Germany Article no.	NM-Germany Article no.	NM-Germany Article no.	NM-Germany Article no.	NM-Germany Article no.	NM-Germany Article no.	NM-Germany Article no.					
			KBSFO60321G	KBFO60321G	KRFO60321G							

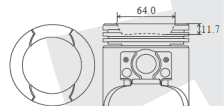

## GASOLINE

ENGINE TYPE Motortyp Type de Moteur Tipo de motor Тип двигателя	LINER KIT Liner Kit Kit de Chemise Camisas de los cilindros лайнер комплект	CYL. LINER Zylinderlaufbuchse Chemise Camisas de los cilindros втулка цилиндра	PISTON + RINGS Kolben + Ringe Piston + Segments Pistón Set Поршень и кольца			PISTON SET Kolben Set Set de Piston Pistón Set поршневой	RINGS SET Kolben Set Segments de Piston Anillos Set кольца	PIN Pin Axe Perno Пин				
<b>XR6 V6</b> 6 Cyl 93.65 mm Bore Ø 2,993 cc		Length: Outside Ø: Flange Ø: flange depth	Length: 95.0 Comp: 46.0 Height: -14.0			Top: 2.0 2nd: 2.0 3rd: 2.0 1st oil: 4.75 2nd oil:	Ø: 23.8 Length: 75.0					
								Reference no.:	Reference no.:	Reference no.:	Reference no.:	O-RING
NM-Germany Article no. Artikelnummer/ Modelo Número / статья НОМЕР	NM-Germany Article no.	NM-Germany Article no.	NM-Germany Article no.	NM-Germany Article no.	NM-Germany Article no.	NM-Germany Article no.	NM-Germany Article no.					
			KBSFO60322G	KBFO60322G	KRFO60322G							

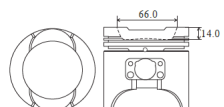

**GASOLINE**



ENGINE TYPE Motortyp Type de Moteur Tipo de motor Тип двигателя	LINER KIT Liner Kit Kit de Chemise Camisas de los cilindros лайнер комплект	CYL. LINER Zylinderlaufbuchse Chemise Camisas de los cilindros втулка цилиндра	PISTON + RINGS Kolben + Ringe Piston + Segments Pistón Set Поршень и кольца	PISTON SET Kolben Set Set de Piston Pistón Set поршневой	RINGS SET Kolben Set Segments de Piston Anillos Set кольца	PIN Pin Axe Perno Пин				
<b>XR6 V6</b> <b>6 Cyl</b> <b>93.65 mm Bore Ø</b> <b>2,993 cc</b>		Length: 86.0 Outside Ø: 46.0 Flange Ø: -14.0 flange depth	Length: 86.0 Comp: 46.0 Height: -14.0		Top: 1.5 2nd: 1.5 3rd: 3.0 1st oil: 2nd oil:	Ø: 22.0 Length: 69.7				
					Reference no.:		Reference no.:	Reference no.:	Reference no.:	O-RING
NM-Germany Article no. Artikelnummer/ Modelo Número / статья НОМЕР	NM-Germany Article no.	NM-Germany Article no.	NM-Germany Article no.	NM-Germany Article no.	NM-Germany Article no.	NM-Germany Article no.				
			<b>KBSFO60323G</b>	<b>KBFO60323G</b>	<b>KRFO60323G</b>					

<b>DIESEL</b>										
ENGINE TYPE Motortyp Type de Moteur Tipo de motor Тип двигателя	LINER KIT Liner Kit Kit de Chemise Camisas de los cilindros лайнер комплект	CYL. LINER Zylinderlaufbuchse Chemise Camisas de los cilindros втулка цилиндра	PISTON + RINGS Kolben + Ringe Piston + Segments Pistón Set Поршень и кольца	PISTON SET Kolben Set Set de Piston Pistón Set поршневой	RINGS SET Kolben Set Segments de Piston Anillos Set кольца	PIN Pin Axe Perno Пин				
<b>4AB/4BA/4BB</b> <b>4CA/4FA</b> <b>4 Cyl</b> <b>93.67 mm Bore Ø</b> <b>2,496 cc</b>		Length: 171.45 Outside Ø: 96.94 Flange Ø: flange depth	Length: 94.0 Comp: 59.5 Height: -5.8 -18.0	alfin	Top: 2.5 double key-stone 2nd: 2.0 3rd: 4.0 1st oil: 2nd oil:	Ø: 29.0 Length: 77.0				
					Reference no.:		Reference no.:	Reference no.:	Reference no.:	O-RING
					<b>755F6055AA</b> <b>A-SU351076</b> <b>G-1401409000</b> <b>K-89032190</b> <b>M-014WV04</b>		<b>H-A350826</b> <b>K-92189600</b> <b>M-0148200</b> <b>N-8778480000</b>	<b>86TM-6110EA2D</b>	<b>894F-6148AA</b> <b>A-R45060</b> <b>G-0878480000</b> <b>K-800009940000</b> <b>M-01482N0</b>	
NM-Germany Article no. Artikelnummer/ Modelo Número / статья НОМЕР	NM-Germany Article no.	NM-Germany Article no.	NM-Germany Article no.	NM-Germany Article no.	NM-Germany Article no.	NM-Germany Article no.				
	<b>LBSFO40324DPA</b>	<b>LBFO40324DPA</b>	<b>KBSFO40324DA</b>	<b>KBFO40324DA</b>	<b>KRFO40324DA</b>					

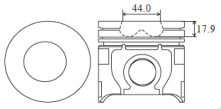

FORD

<b>DIESEL</b>										
ENGINE TYPE Motortyp Type de Moteur Tipo de motor Тип двигателя	LINER KIT Liner Kit Kit de Chemise Camisas de los cilindros лайнер комплект	CYL. LINER Zylinderlaufbuchse Chemise Camisas de los cilindros втулка цилиндра	PISTON + RINGS Kolben + Ringe Piston + Segments Pistón Set Поршень и кольца	PISTON SET Kolben Set Set de Piston Pistón Set поршневой	RINGS SET Kolben Set Segments de Piston Anillos Set кольца	PIN Pin Axe Perno Пин				
<b>4AB/4BA/4BB</b> <b>4CA/4FA/4GA</b> <b>4HB/4HC</b> <b>4 Cyl</b> <b>93.67 mm Bore Ø</b> <b>2,496 cc</b>		Length: 171.45 Outside Ø: 96.94 Flange Ø: flange depth	Length: 94.0 Comp: 59.5 Height: -5.8 -18.0	alfin skirt MOS2 treated	Top: 2.5 half keystone 2nd: 2.0 3rd: 4.0 1st oil: 2nd oil:	Ø: 29.0 Length: 77.0				
					Reference no.:		Reference no.:	Reference no.:	Reference no.:	O-RING
					<b>755F6055AA</b> <b>A-SU351076</b> <b>G-1401409000</b> <b>K-89032190</b> <b>M-014WV04</b>		<b>H-A350999</b> <b>N-8712370030</b>		<b>A-R49520</b> <b>G-0812370000</b>	
NM-Germany Article no. Artikelnummer/ Modelo Número / статья НОМЕР	NM-Germany Article no.	NM-Germany Article no.	NM-Germany Article no.	NM-Germany Article no.	NM-Germany Article no.	NM-Germany Article no.				
	<b>LBSFO0325DPA</b>	<b>LBFO0325DP</b>	<b>KBSFO0325DA</b>	<b>KBFO0325DA</b>	<b>KRFO0325DA</b>					

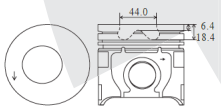

## DIESEL

ENGINE TYPE Motortyp Type de Moteur Tipo de motor Тип двигателя	LINER KIT Liner Kit Kit de Chemise Camisas de los cilindros лайнер комплект	CYL. LINER Zylinderlaufbuchse Chemise Camisas de los cilindros втулка цилиндра	PISTON + RINGS Kolben + Ringe Piston + Segments Pistón Set Поршень и кольца			PISTON SET Kolben Set Set de Piston Pistón Set поршневой	RINGS SET Kolben Set Segments de Piston Anillos Set кольца	PIN Pin Axe Perno Пин
<b>4GB/4GC TURBO</b> <b>4GE/4GF TURBO</b> <b>4HA/4HD TURBO</b> 4 Cyl 93.67 mm Bore Ø 2,496 cc 		Length: 171.45	Length: 94.0		alfin skirt MOS2 treated	Top: 2.5 half keystone	Ø: 29.0 Length: 79.0	
		Outside Ø: 96.94	Comp: 59.5			2nd: 2.0		
		Flange Ø: flange depth	Height: -17.9			3rd: 1st oil: 2nd oil: 4.0		
		Reference no.:	Reference no.:	Reference no.:	Reference no.:	O-RING		
		<b>755F6055AA</b> <b>A-SU351076</b> <b>G-1401409000</b> <b>K-89032190</b> <b>M-014WV04</b>	<b>A-A350502</b> <b>N-8712370010</b>			<b>A-R49520</b> <b>G-0812370000</b>		
NM-Germany Article no. Artikelnummer/ Modelo Número / статья НОМЕР	NM-Germany Article no.	NM-Germany Article no.	NM-Germany Article no.	NM-Germany Article no.	NM-Germany Article no.	NM-Germany Article no.	NM-Germany Article no.	
	LBSFO40326DPA	LBFO40326DPA	KBSFO40326DA	KBFO40326DA	KRFO40326DA			

## DIESEL

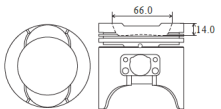

ENGINE TYPE Motortyp Type de Moteur Tipo de motor Тип двигателя	LINER KIT Liner Kit Kit de Chemise Camisas de los cilindros лайнер комплект	CYL. LINER Zylinderlaufbuchse Chemise Camisas de los cilindros втулка цилиндра	PISTON + RINGS Kolben + Ringe Piston + Segments Pistón Set Поршень и кольца			PISTON SET Kolben Set Set de Piston Pistón Set поршневой	RINGS SET Kolben Set Segments de Piston Anillos Set кольца	PIN Pin Axe Perno Пин
<b>4EA TURBO</b> <b>4EB TURBO</b> <b>4EC TURBO</b> 4 Cyl 93.67 mm Bore Ø 2,496 cc 		Length: 171.45	Length: 94.0		alfin skirt MOS2 treated	Top: 2.5 half keystone	Ø: 29.0 Length: 79.0	
		Outside Ø: 96.94	Comp: 59.5			2nd: 2.0		
		Flange Ø: flange depth	Height: -6.4 -18.4			3rd: 1st oil: 2nd oil: 4.0		
		Reference no.:	Reference no.:	Reference no.:	Reference no.:	O-RING		
		<b>755F6055AA</b> <b>A-SU351076</b> <b>G-1401409000</b> <b>K-89032190</b> <b>M-014WV04</b>	<b>A-A350501</b> <b>N-8712370000</b>			<b>A-R49520</b> <b>G-0812370000</b>		
NM-Germany Article no. Artikelnummer/ Modelo Número / статья НОМЕР	NM-Germany Article no.	NM-Germany Article no.	NM-Germany Article no.	NM-Germany Article no.	NM-Germany Article no.	NM-Germany Article no.	NM-Germany Article no.	
	LBSFO40327DPA	LBFO40327DPA	KBSFO40327DA	KBFO40327DA	KRFO40327DA			

## GASOLINE



ENGINE TYPE Motortyp Type de Moteur Tipo de motor Тип двигателя	LINER KIT Liner Kit Kit de Chemise Camisas de los cilindros лайнер комплект	CYL. LINER Zylinderlaufbuchse Chemise Camisas de los cilindros втулка цилиндра	PISTON + RINGS Kolben + Ringe Piston + Segments Pistón Set Поршень и кольца			PISTON SET Kolben Set Set de Piston Pistón Set поршневой	RINGS SET Kolben Set Segments de Piston Anillos Set кольца	PIN Pin Axe Perno Пин
<b>ESSEX V4</b> <b>ESSEX 3.0 V6</b> 4/6 Cyl 93.65 mm Bore Ø 1,995 cc 2,993 cc 		Length:	Length: 95.0			Top: 2.0	Ø: 23.8 Length: 75.0	
		Outside Ø:	Comp: 46.0			2nd: 2.0		
		Flange Ø: flange depth	Height: -14.0			3rd: 1st oil: 2nd oil: 4.75		
		Reference no.:	Reference no.:	Reference no.:	Reference no.:	O-RING		
NM-Germany Article no. Artikelnummer/ Modelo Número / статья НОМЕР	NM-Germany Article no.	NM-Germany Article no.	NM-Germany Article no.	NM-Germany Article no.	NM-Germany Article no.	NM-Germany Article no.	NM-Germany Article no.	
			KBSFO460328G	KBFO460328G	KRFO460328G			

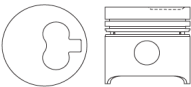

**DIESEL**



ENGINE TYPE Motortyp Type de Moteur Tipo de motor Тип двигателя	LINER KIT Liner Kit Kit de Chemise Camisas de los cilindros лайнер комплект	CYL. LINER Zylinderlaufbuchse Chemise Camisas de los cilindros втулка цилиндра	PISTON + RINGS Kolben + Ringe Piston + Segments Pistón Set Поршень и кольца			PISTON SET Kolben Set Set de Piston Pistón Set поршневой	RINGS SET Kolben Set Segments de Piston Anillos Set кольца	PIN Pin Axe Perno Пин
<b>STP STR</b> 4 Cyl 94.0 mm Bore Ø 2,498 cc	<b>LKFO409401S</b> <b>K-93625960</b> <b>M-0395192</b>	Length: 165.8 Outside Ø: 97.0 Flange Ø: 99.5 flange depth 3.9	Length: 96.42 Comp: 53.92 Height: -1.8		alfin	Top: 2.0	Ø: 30.0 Length: 78.8	
						2nd: 2.0		
						3rd: 2.0		
					1st oil: 4.0	2nd oil:		
		<b>Reference no.:</b>	<b>Reference no.:</b>	<b>Reference no.:</b>	<b>Reference no.:</b>	<b>O-RING</b>		
	<b>K-89412190</b> <b>M-039WV30</b> <b>PTFO409401DA</b>	<b>PKFO409401D</b> <b>A-350708</b> <b>K-93625600</b> <b>M-0395100</b> <b>N-8731870010</b>			<b>A-R66140</b> <b>G-0831870010</b> <b>K-800004140000</b> <b>M-03948N0</b>			
NM-Germany Article no. Artikelnummer/ Modelo Número / статья НОМЕР	NM-Germany Article no.	NM-Germany Article no.	NM-Germany Article no.	NM-Germany Article no.	NM-Germany Article no.	NM-Germany Article no.	NM-Germany Article no.	
	<b>LBSFO40329DSA</b> <b>LBSFO40329DSA</b>	<b>LBFO40329DSA</b>	<b>KBSFO40329DA</b> <b>KBSFO40329DA</b>	<b>KBFO40329DA</b> <b>KBFO40329DA</b>	<b>KRFO40329DA</b>			

**DIESEL**

ENGINE TYPE Motortyp Type de Moteur Tipo de motor Тип двигателя	LINER KIT Liner Kit Kit de Chemise Camisas de los cilindros лайнер комплект	CYL. LINER Zylinderlaufbuchse Chemise Camisas de los cilindros втулка цилиндра	PISTON + RINGS Kolben + Ringe Piston + Segments Pistón Set Поршень и кольца			PISTON SET Kolben Set Set de Piston Pistón Set поршневой	RINGS SET Kolben Set Segments de Piston Anillos Set кольца	PIN Pin Axe Perno Пин
<b>LXD 2 YTR YTT</b> 4 Cyl 94.0 mm Bore Ø 2,304 cc	<b>K-93520960</b> <b>M-0395090</b>	Length: 170.6 Outside Ø: 97.0 Flange Ø: 99.5 flange depth 3.9	Length: 99.92 Comp: 57.42 Height: -1.8			Top: 2.0	Ø: 30.0 Length: 78.8	
						2nd: 2.0		
						3rd: 2.0		
					1st oil: 4.0	2nd oil:		
		<b>Reference no.:</b>	<b>Reference no.:</b>	<b>Reference no.:</b>	<b>Reference no.:</b>	<b>O-RING</b>		
	<b>K-89033190</b> <b>M-039WV16</b>	<b>A-350707</b> <b>K-93520600</b> <b>M-0395000</b> <b>N-8731870000</b>	<b>83EM-6K100AA</b>		<b>A-R66140</b> <b>G-0831870010</b> <b>K-800004140000</b> <b>M-03948N0</b>			
NM-Germany Article no. Artikelnummer/ Modelo Número / статья НОМЕР	NM-Germany Article no.	NM-Germany Article no.	NM-Germany Article no.	NM-Germany Article no.	NM-Germany Article no.	NM-Germany Article no.	NM-Germany Article no.	
	<b>LBSFO40330DS</b>	<b>LBFO40330DS</b>	<b>KBSFO40330D</b>	<b>KBFO40330D</b>	<b>KRFO40330D</b>			

FORD

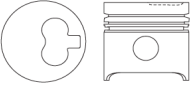
**DIESEL**

ENGINE TYPE Motortyp Type de Moteur Tipo de motor Тип двигателя	LINER KIT Liner Kit Kit de Chemise Camisas de los cilindros лайнер комплект	CYL. LINER Zylinderlaufbuchse Chemise Camisas de los cilindros втулка цилиндра	PISTON + RINGS Kolben + Ringe Piston + Segments Pistón Set Поршень и кольца			PISTON SET Kolben Set Set de Piston Pistón Set поршневой	RINGS SET Kolben Set Segments de Piston Anillos Set кольца	PIN Pin Axe Perno Пин
<b>XD 2S TURBO</b> 4 Cyl 94.0 mm Bore Ø 2,304 cc	<b>M-0395290</b>	Length: 170.6 Outside Ø: 97.0 Flange Ø: 99.5 flange depth 3.9	Length: 99.87 Comp: 57.37 Height: -1.95		alfin	Top: 3.0	Ø: 30.0 Length: 78.0	
						double key-stone		
						2nd: 2.0		
					1st oil: 4.0	2nd oil:		
		<b>Reference no.:</b>	<b>Reference no.:</b>	<b>Reference no.:</b>	<b>Reference no.:</b>	<b>O-RING</b>		
	<b>K-89033190</b> <b>M-039WV16</b>	<b>K-93703600</b> <b>M-0395200</b>			<b>A-R66000</b> <b>G-0832020010</b> <b>M-03947N0</b> <b>M-03952N0</b>			
NM-Germany Article no. Artikelnummer/ Modelo Número / статья НОМЕР	NM-Germany Article no.	NM-Germany Article no.	NM-Germany Article no.	NM-Germany Article no.	NM-Germany Article no.	NM-Germany Article no.	NM-Germany Article no.	
	<b>LBSFO40331DSA</b>	<b>LBFO40331DSA</b>	<b>KBSFO40331DA</b>	<b>KBFO40331DA</b>	<b>KRFO40331DA</b>			

## DIESEL

ENGINE TYPE Motortyp Type de Moteur Tipo de motor Тип двигателя	LINER KIT Liner Kit Kit de Chemise Camisas de los cilindros лайнер комплект	CYL. LINER Zylinderlaufbuchse Chemise Camisas de los cilindros втулка цилиндра	PISTON + RINGS Kolben + Ringe Piston + Segments Pistón Set Поршень и кольца	PISTON SET Kolben Set Set de Piston Pistón Set поршневой	RINGS SET Kolben Set Segments de Piston Anillos Set кольца	PIN Pin Axe Perno Пин
<b>SFA TURBO SFB TURBO</b>  <b>4 Cyl</b>  <b>94.0 mm Bore Ø</b>  <b>2,498 cc</b>	<b>K-93608960 M-0394792</b>	Length: 165.8 Outside Ø: 97.0 Flange Ø: 99.5 flange depth 3.9	Length: 96.37 Comp: 53.87 Height: -2.27	alfin and with oil gallery skirt MOS2 treated	Top: 3.0 double key-stone 2nd: 2.0 3rd: 2.0 1st oil: 4.0 2nd oil:	Ø: 32.0 Length: 78.8
		<b>Reference no.:</b>	<b>Reference no.:</b>	<b>Reference no.:</b>	<b>Reference no.:</b>	<b>O-RING</b>
		<b>K-89412190 M-039VV30</b>	<b>K-93608600 M-0394700</b>		<b>A-R66000 G-0832020010 M-03947N0 M-03952N0</b>	
		NM-Germany Article no. Artikelnummer/ Modelo Número / статья НОМЕР	NM-Germany Article no.	NM-Germany Article no.	NM-Germany Article no.	NM-Germany Article no.
	<b>LBSFO40332DSB</b>	<b>LBFO40332DSB</b>	<b>KBSFO40332DB</b>	<b>KBFO40332DB</b>	<b>KRFO40332DB</b>	

## GASOLINE

ENGINE TYPE Motortyp Type de Moteur Tipo de motor Тип двигателя	LINER KIT Liner Kit Kit de Chemise Camisas de los cilindros лайнер комплект	CYL. LINER Zylinderlaufbuchse Chemise Camisas de los cilindros втулка цилиндра	PISTON + RINGS Kolben + Ringe Piston + Segments Pistón Set Поршень и кольца	PISTON SET Kolben Set Set de Piston Pistón Set поршневой	RINGS SET Kolben Set Segments de Piston Anillos Set кольца	PIN Pin Axe Perno Пин
<b>ESSEX 3.4 V6</b>  <b>6 Cyl</b>  <b>94.67 mm Bore Ø</b>  <b>3,376 cc</b>		Length: Outside Ø: Flange Ø: flange depth	Length: 69.9 Comp: 40.0 Height: -12.2	skirt MOS2 treated	Top: 1.5 2nd: 1.5 3rd: 1.5 1st oil: 3.0 2nd oil:	Ø: 24.0 Length: 68.8
		<b>Reference no.:</b>	<b>Reference no.:</b>	<b>Reference no.:</b>	<b>Reference no.:</b>	<b>O-RING</b>
		NM-Germany Article no. Artikelnummer/ Modelo Número / статья НОМЕР	NM-Germany Article no.	NM-Germany Article no.	NM-Germany Article no.	NM-Germany Article no.
			<b>KBSFO60333G</b>	<b>KBFO60333G</b>	<b>KRFO60333G</b>	

## DIESEL

ENGINE TYPE Motortyp Type de Moteur Tipo de motor Тип двигателя	LINER KIT Liner Kit Kit de Chemise Camisas de los cilindros лайнер комплект	CYL. LINER Zylinderlaufbuchse Chemise Camisas de los cilindros втулка цилиндра	PISTON + RINGS Kolben + Ringe Piston + Segments Pistón Set Поршень и кольца	PISTON SET Kolben Set Set de Piston Pistón Set поршневой	RINGS SET Kolben Set Segments de Piston Anillos Set кольца	PIN Pin Axe Perno Пин
<b>TD27T</b>  <b>4 Cyl</b>  <b>96.0 mm Bore Ø</b>  <b>2,664 cc</b>	<b>K-94406960</b>	Length: 160.0 Outside Ø: 99.0 Flange Ø: 105.0 flange depth 5.0	Length: 87.2 Comp: 50.4 Height: -1.4	alfin and with oil gallery head anodized skirt MOS2 treated	Top: 2.5 half keystone 2nd: 2.0 3rd: 2.0 1st oil: 3.0 2nd oil:	Ø: 30.0 Length: 80.0
		<b>Reference no.:</b>	<b>Reference no.:</b>	<b>Reference no.:</b>	<b>Reference no.:</b>	<b>O-RING</b>
		<b>11012-43G00 11012-43G05 11012-43G10 11012-2S000 K-89449190</b>	<b>K-94406600</b>	<b>12010-0W820 12010-0W821 12010-0W82A</b>	<b>12033-0W813 12033-0W814 12033-0W81A 12033-2W211 12033-7F400 12033-NA010</b>	
		NM-Germany Article no. Artikelnummer/ Modelo Número / статья НОМЕР	NM-Germany Article no.	NM-Germany Article no.	NM-Germany Article no.	NM-Germany Article no.
	<b>LBSFO40334DSB</b>	<b>LBFO40334DSB</b>	<b>KBSFO40334DB</b>	<b>KBFO40334DB</b>	<b>KRFO40334DB</b>	

**GASOLINE**

ENGINE TYPE Motortyp Type de Moteur Tipo de motor Тип двигателя	LINER KIT Liner Kit Kit de Chemise Camisas de los cilindros лайнер комплект	CYL. LINER Zylinderlaufbuchse Chemise Camisas de los cilindros втулка цилиндра	PISTON + RINGS Kolben + Ringe Piston + Segments Pistón Set Поршень и кольца			PISTON SET Kolben Set Set de Piston Pistón Set поршневой	RINGS SET Kolben Set Segments de Piston Anillos Set кольца	PIN Pin Axe Perno Пин
<b>L4 153 CID</b> 4 Cyl 96.0 mm Bore Ø 2,474 cc		Length: Outside Ø: Flange Ø: flange depth	Length:	63.2			Top: 1.5	Ø: 23.17 Length: 66.0
			Comp:	30.7			2nd: 1.5	
			Height:	-2.2			3rd: 3.0	
			Reference no.:	Reference no.:	Reference no.:	Reference no.:	O-RING	
					<b>F87Z-6108HA</b> <b>F87Z-6108JA</b>	<b>HT-2C4912</b> <b>M-41726</b>		
NM-Germany Article no. Artikelnummer/ Modelo Número / статья НОМЕР	NM-Germany Article no.	NM-Germany Article no.	NM-Germany Article no.	NM-Germany Article no.	NM-Germany Article no.	NM-Germany Article no.	NM-Germany Article no.	
			<b>KBSFO40335G</b>	<b>KBFO40335G</b>	<b>KRFO40335G</b>			

ENGINE TYPE Motortyp Type de Moteur Tipo de motor Тип двигателя	LINER KIT Liner Kit Kit de Chemise Camisas de los cilindros лайнер комплект	CYL. LINER Zylinderlaufbuchse Chemise Camisas de los cilindros втулка цилиндра	PISTON + RINGS Kolben + Ringe Piston + Segments Pistón Set Поршень и кольца			PISTON SET Kolben Set Set de Piston Pistón Set поршневой	RINGS SET Kolben Set Segments de Piston Anillos Set кольца	PIN Pin Axe Perno Пин
<b>245 CID</b> 6 Cyl 100.4 mm Bore Ø 4,015 cc		Length: Outside Ø: Flange Ø: flange depth	Length:	69.8			Top: 1.6	Ø: 24.0 Length: 72.0
			Comp:	36.9			2nd: 1.75	
			Height:	-7.7			3rd: 3.5	
			Reference no.:	Reference no.:	Reference no.:	Reference no.:	O-RING	
					<b>F6TZ-6108PA</b> <b>F6TZ-6108RA F8TZ-6108AA</b>	<b>F0TZ-6148M</b> <b>M-51550CP</b> <b>M-A59310</b> <b>N-SWT20-072</b>		
NM-Germany Article no. Artikelnummer/ Modelo Número / статья НОМЕР	NM-Germany Article no.	NM-Germany Article no.	NM-Germany Article no.	NM-Germany Article no.	NM-Germany Article no.	NM-Germany Article no.	NM-Germany Article no.	
			<b>KBSFO60336G</b>	<b>KBFO60336G</b>	<b>KRFO60336G</b>			

**DIESEL**

ENGINE TYPE Motortyp Type de Moteur Tipo de motor Тип двигателя	LINER KIT Liner Kit Kit de Chemise Camisas de los cilindros лайнер комплект	CYL. LINER Zylinderlaufbuchse Chemise Camisas de los cilindros втулка цилиндра	PISTON + RINGS Kolben + Ringe Piston + Segments Pistón Set Поршень и кольца			PISTON SET Kolben Set Set de Piston Pistón Set поршневой	RINGS SET Kolben Set Segments de Piston Anillos Set кольца	PIN Pin Axe Perno Пин
<b>2700/2701</b> <b>E/2706 E</b> <b>2704 E/2709 E</b> 4/6 Cyl 104.77 mm Bore Ø 3,966 cc 5,944 cc	<b>K-90495960</b> <b>M-0143590</b>	Length: 219.0 Outside Ø: 108.8 Flange Ø: flange depth	Length:	118.0			Top: 2.39	Ø: 34.93 Length: 90.0
			Comp:	71.0			2nd: 2.39	
			Height:	-25.9			3rd: 2.39	
			Reference no.:	Reference no.:	Reference no.:	Reference no.:	O-RING	
			<b>2701E6055B</b> <b>A-SU517801</b> <b>G-1401370000</b> <b>K-88141190</b> <b>M-014WV02</b>	<b>A-350067</b> <b>K-90495600</b> <b>M-0143500</b> <b>N-8720280000</b>		<b>A-R40040</b> <b>G-0820280000</b> <b>K-800010010000</b> <b>M-01571N0</b>		
NM-Germany Article no. Artikelnummer/ Modelo Número / статья НОМЕР	NM-Germany Article no.	NM-Germany Article no.	NM-Germany Article no.	NM-Germany Article no.	NM-Germany Article no.	NM-Germany Article no.	NM-Germany Article no.	
	<b>LBSFO460337DP</b>	<b>LBFO460337DP</b>	<b>KBSFO460337D</b>	<b>KBFO460337D</b>	<b>KRFO460337D</b>			

## DIESEL



ENGINE TYPE	LINER KIT	CYL. LINER	PISTON + RINGS	PISTON SET	RINGS SET	PIN
<b>2504 E/ND RD</b> 3/4 Cyl 106.69 mm Bore Ø 2,870 cc 3,815 cc	(B) <b>K-93566960</b>	Length: 209.6 Outside Ø: 110.78 Flange Ø: flange depth	Length: 129.0 Comp: 70.2 Height: -17.1	alfin	Top: 2.38 2nd: 2.38 3rd: 2.38 1st oil: 4.75 2nd oil:	Ø: 38.1 Length: 89.0
		<b>Reference no.:</b>	<b>Reference no.:</b>	<b>Reference no.:</b>	<b>Reference no.:</b>	<b>O-RING</b>
			<b>C5NN6108V</b> <b>C7NN6108AJ</b> <b>D4NN6108L</b> <b>G-0820810000</b> <b>K-800010110000</b> <b>M-1703N0</b> <b>A-SU522801</b> <b>K-88500190</b> <b>M-014WV03</b> <b>LKFO110671PA</b>	<b>K-93566960</b> <b>PKFO110671DA</b>	<b>A-A350199V1</b> <b>K-93566600</b> <b>M-0148900</b> <b>N-8720810010</b> <b>D4NN6108N</b> <b>D6NN6108P DN-</b> <b>W6108AJ</b> <b>PTFO110671DA</b> <b>N-1401077000</b>	
NM-Germany Article no. Artikelnummer/ Modelo Número / статья НОМЕР	NM-Germany Article no.	NM-Germany Article no.	NM-Germany Article no.	NM-Germany Article no.	NM-Germany Article no.	NM-Germany Article no.
	<b>LBSFO340338DP</b>  (B) <b>LBSFO340338DPA</b>	<b>LBFO340338DPA</b>	<b>KBSFO340338DA</b> <b>KBSFO340338DA</b>	<b>KBFO340338DA</b> <b>KBFO340338DA</b>	<b>KRFO340338DA</b>	

## DIESEL

ENGINE TYPE	LINER KIT	CYL. LINER	PISTON + RINGS	PISTON SET	RINGS SET	PIN
<b>2711 E/2712 E/2722</b> <b>2714 E/2715 C/2725</b> 4/6 Cyl 107.21 mm Bore Ø 4,161 cc 6,227 cc	(A) <b>K-92587960</b> <b>M-0143890</b>	Length: 212.73 Outside Ø: 111.39 Flange Ø: flange depth	Length: 119.9 Comp: 71.2 Height: -19.0 -27.8	alfin	Top: 2.39 2nd: 2.39 3rd: 2.39 1st oil: 4.75 2nd oil:	Ø: 36.512 Length: 90.0
		<b>Reference no.:</b>	<b>Reference no.:</b>	<b>Reference no.:</b>	<b>Reference no.:</b>	<b>O-RING</b>
		<b>K-89158190</b> <b>M-014WV11</b>	(E) <b>H-350031V1</b> <b>K-92587600</b> <b>M-0143800</b> <b>N-8721480010</b>	<b>703F-6102AAB</b> <b>703F-6110AAB</b> <b>793F-6102AAA</b> <b>793F-6102BAA</b>	<b>703F-6148A</b> <b>A-R40110</b> <b>G-0821480010</b> <b>K-800010211000</b> <b>M-01438N0</b>	
NM-Germany Article no. Artikelnummer/ Modelo Número / статья НОМЕР	NM-Germany Article no.	NM-Germany Article no.	NM-Germany Article no.	NM-Germany Article no.	NM-Germany Article no.	NM-Germany Article no.
	<b>LBSFO460339DP (A)</b> <b>LBSFO460339DPA</b>	<b>LBFO460339DPA</b>	<b>KBSFO460339D (E)</b> <b>KBSFO460339DA</b>	<b>KBFO460339D</b> <b>KBFO460339DA</b>	<b>KRFO460339DA</b>	

## DIESEL

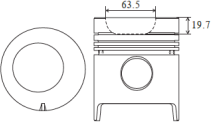
ENGINE TYPE	LINER KIT	CYL. LINER	PISTON + RINGS	PISTON SET	RINGS SET	PIN
<b>2514 E/256</b> 4 Cyl 111.77 mm Bore Ø 4,195 cc	(B) <b>M-0144990</b>	Length: 208.53 Outside Ø: 114.43 Flange Ø: 120.35 flange depth 2.56	Length: 129.5 Comp: 70.6 Height: -18.6	alfin	Top: 2.39 2nd: 2.39 3rd: 2.39 1st oil: 4.75 2nd oil:	Ø: 38.1 Length: 89.0
		<b>Reference no.:</b>	<b>Reference no.:</b>	<b>Reference no.:</b>	<b>Reference no.:</b>	<b>O-RING</b>
		<b>A-SU351030</b> <b>G-1402161000</b> <b>M-014WV06</b>	(F): <b>A-A350202V2</b> <b>N-8720240000</b> <b>K-97505600</b> <b>M-0144900</b>	<b>M-0144990</b> <b>PKFO411171DA</b>	<b>A-A350202V2</b> <b>N-8720240000</b> <b>K-97505600</b> <b>M-0144900</b> <b>PTFO411171DA</b>	
NM-Germany Article no. Artikelnummer/ Modelo Número / статья НОМЕР	NM-Germany Article no.	NM-Germany Article no.	NM-Germany Article no.	NM-Germany Article no.	NM-Germany Article no.	NM-Germany Article no.
	<b>LBSFO0340DS</b> <b>LBSFO0340DSA (B)</b>	<b>LBFO0340DSA</b>	<b>KBSFO0340D</b> <b>KBSFO0340DA (F)</b>	<b>KBFO0340DA</b> <b>KBFO0340DA</b>	<b>KRFO0340DA</b>	

ENGINE TYPE Motortyp Type de Moteur Tipo de motor Тип двигателя	LINER KIT Liner Kit Kit de Chemise Camisas de los cilindros лайнер комплект	CYL. LINER Zylinderlaufbuchse Chemise Camisas de los cilindros штулка цилиндра	PISTON + RINGS Kolben + Ringe Piston + Segments Pistón Set Поршень и кольца		PISTON SET Kolben Set Set de Piston Pistón Set поршенькой	RINGS SET Kolben Set Segments de Piston Anillos Set кольца	PIN Pin Axe Perno Пин
<b>201/BSD 333H</b> <b>256</b> <b>401</b> 3/4/6 Cyl 111.77 mm Bore Ø 3,294 cc 4,195 cc 6,571 cc 	PKFO111172D	Length: 208.53 Outside Ø: 114.43 Flange Ø: 120.35 flange depth 2.56	Length: 127.0 Comp: 68.1 Height: -19.7		alfin	Top: 2.39 2nd: 2.39 3rd: 2.39 1st oil: 4.75 2nd oil:	Ø: 38.1 Length: 89.0
		Reference no.:	Reference no.:	Reference no.:	Reference no.:	O-RING	
		<b>A-SU351030</b> <b>G-1402161000</b> <b>M-014WV06</b>	(F) <b>A-A350382</b> <b>N-8720240010</b>		<b>A-R31640</b> <b>G-0820240010</b> <b>K-800010311000</b> <b>M-01442N0</b>		
NM-Germany Article no. Artikelnummer/ Modelo Número / статья НОМЕР	NM-Germany Article no.	NM-Germany Article no.	NM-Germany Article no.	NM-Germany Article no.	NM-Germany Article no.	NM-Germany Article no.	NM-Germany Article no.
	LBSFO3460341DS LBSFO3460341DSA	LBFO3460341DSA	KBSFO3460341D KBSFO3460341DA (F)	KBFO3460341D KBFO3460341DA	KRFO3460341DA		

**GASOLINE**

ENGINE TYPE Motortyp Type de Moteur Tipo de motor Тип двигателя	LINER KIT Liner Kit Kit de Chemise Camisas de los cilindros лайнер комплект	CYL. LINER Zylinderlaufbuchse Chemise Camisas de los cilindros втулка цилиндра	PISTON + RINGS Kolben + Ringe Piston + Segments Pistón Set Поршень и кольца		PISTON SET Kolben Set Set de Piston Pistón Set поршень	RINGS SET Kolben Set Segments de Piston Anillos Set кольца	PIN Pin Axe Perno Пин
<b>115 C</b> <b>4 Cyl</b> <b>77.0 mm Bore Ø</b> <b>1,481 cc</b>	<b>M-0075290</b> <b>K-90395600</b> <b>M-007WV70</b> <b>M-0075200</b>	Length: 133.0	Length: 89.0			Top: 2.0	Ø: 22.0 Length: 65.0
		Outside Ø: 81.0 Flange Ø: flange depth	Comp: 36.5 Height: +9.5			2nd: 2.0 3rd: 1st oil: 3.95 2nd oil:	
		<b>Reference no.:</b>	<b>Reference no.:</b>	<b>Reference no.:</b>	<b>Reference no.:</b>	<b>O-RING</b>	
NM-Germany Article no. Artikelnummer/ Modelo Número / статья НОМЕР	NM-Germany Article no.	NM-Germany Article no.	NM-Germany Article no.	NM-Germany Article no.	NM-Germany Article no.	NM-Germany Article no.	NM-Germany Article no.
	LBSFS40342GP	LBFS40342GP	KBSFS40342G	KBFS40342G	KRFS40342G		

**GASOLINE**

ENGINE TYPE Motortyp Type de Moteur Tipo de motor Тип двигателя	LINER KIT Liner Kit Kit de Chemise Camisas de los cilindros лайнер комплект	CYL. LINER Zylinderlaufbuchse Chemise Camisas de los cilindros втулка цилиндра	PISTON + RINGS Kolben + Ringe Piston + Segments Pistón Set Поршень и кольца		PISTON SET Kolben Set Set de Piston Pistón Set поршень	RINGS SET Kolben Set Segments de Piston Anillos Set кольца	PIN Pin Axe Perno Пин
<b>132 AB 0A</b> <b>4 Cyl</b> <b>80.0 mm Bore Ø</b> <b>1,592 cc</b>		Length: 81.8	Length: 81.8			Top: 1.5	Ø: 22.0 Length: 68.0
		Outside Ø: Flange Ø: flange depth	Comp: 37.7 Height: 4.6			2nd: 2.0 3rd: 1st oil: 3.95 2nd oil:	
		<b>Reference no.:</b>	<b>Reference no.:</b>	<b>Reference no.:</b>	<b>Reference no.:</b>	<b>O-RING</b>	
			<b>K-92472600</b> <b>M-0075600</b>		<b>A-R47750</b> <b>G-0820310000</b> <b>K-800006141000</b> <b>M-00765N0</b>		
NM-Germany Article no. Artikelnummer/ Modelo Número / статья НОМЕР	NM-Germany Article no.	NM-Germany Article no.	NM-Germany Article no.	NM-Germany Article no.	NM-Germany Article no.	NM-Germany Article no.	NM-Germany Article no.
			KBSFS40343G	KBFS40343G	KRFS40343G		

**GASOLINE**

ENGINE TYPE Motortyp Type de Moteur Tipo de motor Тип двигателя	LINER KIT Liner Kit Kit de Chemise Camisas de los cilindros лайнер комплект	CYL. LINER Zylinderlaufbuchse Chemise Camisas de los cilindros втулка цилиндра	PISTON + RINGS Kolben + Ringe Piston + Segments Pistón Set Поршень и кольца		PISTON SET Kolben Set Set de Piston Pistón Set поршень	RINGS SET Kolben Set Segments de Piston Anillos Set кольца	PIN Pin Axe Perno Пин
<b>132 A</b> <b>132 AB</b> <b>132 B/132 BB</b> <b>4 Cyl</b> <b>84.0 mm Bore Ø</b> <b>1,756 cc</b>		Length: 79.9	Length: 79.9			Top: 1.5	Ø: 22.0 Length: 69.0
		Outside Ø: Flange Ø: flange depth	Comp: 38.4 Height: 2.0			2nd: 2.0 3rd: 1st oil: 3.95 2nd oil:	
		<b>Reference no.:</b>	<b>Reference no.:</b>	<b>Reference no.:</b>	<b>Reference no.:</b>	<b>O-RING</b>	
			<b>K-92425600</b> <b>M-0077500</b>		<b>A-R46970</b> <b>G-0821530010</b> <b>K-800006541000</b> <b>M-00865N0</b>		
NM-Germany Article no. Artikelnummer/ Modelo Número / статья НОМЕР	NM-Germany Article no.	NM-Germany Article no.	NM-Germany Article no.	NM-Germany Article no.	NM-Germany Article no.	NM-Germany Article no.	NM-Germany Article no.
			KBSFS40344G	KBFS40344G	KRFS40344G		

**GASOLINE**

ENGINE TYPE Motortyp Type de Moteur Tipo de motor Тип двигателя	LINER KIT Liner Kit Kit de Chemise Camisas de los cilindros лайнер комплект	CYL. LINER Zylinderlaufbuchse Chemise Camisas de los cilindros втулка цилиндра	PISTON + RINGS Kolben + Ringe Piston + Segments Pistón Set Поршень и кольца			PISTON SET Kolben Set Set de Piston Pistón Set поршеньной	RINGS SET Kolben Set Segments de Piston Anillos Set кольца	PIN Pin Axe Perno Пин
<b>C 14 SE</b> 4 Cyl 77.6 mm Bore Ø 1,389 cc		Length: Outside Ø: Flange Ø: flange depth	Length: Comp: Height:	52.55 32.05 0	head, top and 2nd ring lands anodized	Top:	1.5	Ø: 18.0 Length: 55.0
						2nd:	1.5	
						3rd:	1.5	
						1st oil:	3.0	
						2nd oil:		
			Reference no.:	Reference no.:	Reference no.:	Reference no.:	O-RING	
NM-Germany Article no. Artikelnummer/ Modelo Número / статья НОМЕР	NM-Germany Article no.	NM-Germany Article no.	NM-Germany Article no.	NM-Germany Article no.	NM-Germany Article no.	NM-Germany Article no.	NM-Germany Article no.	NM-Germany Article no.
			KBSGM40346G	KBGM40346G	KRGM40346G			

ENGINE TYPE Motortyp Type de Moteur Tipo de motor Тип двигателя	LINER KIT Liner Kit Kit de Chemise Camisas de los cilindros лайнер комплект	CYL. LINER Zylinderlaufbuchse Chemise Camisas de los cilindros втулка цилиндра	PISTON + RINGS Kolben + Ringe Piston + Segments Pistón Set Поршень и кольца			PISTON SET Kolben Set Set de Piston Pistón Set поршеньной	RINGS SET Kolben Set Segments de Piston Anillos Set кольца	PIN Pin Axe Perno Пин
<b>X 18 XE</b> 4 Cyl 80.5 mm Bore Ø 1,796 cc		Length: Outside Ø: Flange Ø: flange depth	Length: Comp: Height:	44.7 24.1 -1.2		Top:	1.2	Ø: 18.0 Length: 57.0
						2nd:	1.2	
						3rd:	1.2	
						1st oil:	2.0	
						2nd oil:		
			Reference no.:	Reference no.:	Reference no.:	Reference no.:	O-RING	
				M-S14195	7 084 581 M-E14195	M-A14195		
NM-Germany Article no. Artikelnummer/ Modelo Número / статья НОМЕР	NM-Germany Article no.	NM-Germany Article no.	NM-Germany Article no.	NM-Germany Article no.	NM-Germany Article no.	NM-Germany Article no.	NM-Germany Article no.	NM-Germany Article no.
			KBSGM40347G	KBGM40347G	KRGM40347G			

GM

ENGINE TYPE Motortyp Type de Moteur Tipo de motor Тип двигателя	LINER KIT Liner Kit Kit de Chemise Camisas de los cilindros лайнер комплект	CYL. LINER Zylinderlaufbuchse Chemise Camisas de los cilindros втулка цилиндра	PISTON + RINGS Kolben + Ringe Piston + Segments Pistón Set Поршень и кольца			PISTON SET Kolben Set Set de Piston Pistón Set поршеньной	RINGS SET Kolben Set Segments de Piston Anillos Set кольца	PIN Pin Axe Perno Пин
<b>2.4L SOHC 8V</b> 4 Cyl 87.5 mm Bore Ø 2,404 cc		Length: Outside Ø: Flange Ø: flange depth	Length: Comp: Height:	50.3 27.3 -1.5 -6.4	top and 2nd ring lands anodized	Top:	1.2	Ø: 21.0 Length: 61.5
						2nd:	1.5	
						3rd:	1.5	
						1st oil:	2.5	
						2nd oil:		
			Reference no.:	Reference no.:	Reference no.:	Reference no.:	O-RING	
				M-S14710	933 251 89 M-E14710 M-P9123	M-A14710 M-PS4848		
NM-Germany Article no. Artikelnummer/ Modelo Número / статья НОМЕР	NM-Germany Article no.	NM-Germany Article no.	NM-Germany Article no.	NM-Germany Article no.	NM-Germany Article no.	NM-Germany Article no.	NM-Germany Article no.	NM-Germany Article no.
			KBSGM40348G	KBGM40348G	KRGM40348G			

## GASOLINE

ENGINE TYPE Motortyp Type de Moteur Tipo de motor Тип двигателя	LINER KIT Liner Kit Kit de Chemise Camisas de los cilindros лайнер комплект	CYL. LINER Zylinderlaufbuchse Chemise Camisas de los cilindros втулка цилиндра	PISTON + RINGS Kolben + Ringe Piston + Segments Pistón Set Поршень и кольца			PISTON SET Kolben Set Set de Piston Pistón Set поршневой	RINGS SET Kolben Set Segments de Piston Anillos Set кольца	PIN Pin Axe Perno Пин			
<b>LY7 (213/220 CID)</b> 6 Cyl 94.0 mm Bore Ø 3,564 cc		Length: Outside Ø: Flange Ø: flange depth	Length: 55.0 Comp: 32.0 Height: -3.4		skirt MOS2 treated	Top: 1.2 2nd: 1.5 3rd: 1st oil: 2.5 2nd oil:	Ø: 24.0 Length: 60.9				
						Reference no.:		Reference no.:	Reference no.:	Reference no.:	O-RING
									92068320 92068321	12616973 HT-2C5133	
NM-Germany Article no. Artikelnummer/ Modelo Número / статья НОМЕР	NM-Germany Article no.	NM-Germany Article no.	NM-Germany Article no.	NM-Germany Article no.	NM-Germany Article no.	NM-Germany Article no.	NM-Germany Article no.				
			KBSGM60349G	KBGM60349G	KRGM60349G						

## GASOLINE

ENGINE TYPE Motortyp Type de Moteur Tipo de motor Тип двигателя	LINER KIT Liner Kit Kit de Chemise Camisas de los cilindros лайнер комплект	CYL. LINER Zylinderlaufbuchse Chemise Camisas de los cilindros втулка цилиндра	PISTON + RINGS Kolben + Ringe Piston + Segments Pistón Set Поршень и кольца			PISTON SET Kolben Set Set de Piston Pistón Set поршневой	RINGS SET Kolben Set Segments de Piston Anillos Set кольца	PIN Pin Axe Perno Пин			
<b>LLT (220 CID) (L/R)</b> 6 Cyl 94.0 mm Bore Ø 3,564 cc		Length: Outside Ø: Flange Ø: flange depth	Length: 56.35 Comp: 30.15 Height: 3.35 -0.5		head, top and 2nd ring lands anodized skirt MOS2 treated fits tapered con. rod	Top: 1.2 2nd: 1.5 3rd: 1st oil: 2.5 2nd oil:	Ø: 24.0 Length: 53.0				
						Reference no.:		Reference no.:	Reference no.:	Reference no.:	O-RING
									1216971(L) 1216972(R)	12616973 HT-2C5133	
NM-Germany Article no. Artikelnummer/ Modelo Número / статья НОМЕР	NM-Germany Article no.	NM-Germany Article no.	NM-Germany Article no.	NM-Germany Article no.	NM-Germany Article no.	NM-Germany Article no.	NM-Germany Article no.				
			KBSGM60350G	KBGM60350G	KRGM60350G						

## GASOLINE

ENGINE TYPE Motortyp Type de Moteur Tipo de motor Тип двигателя	LINER KIT Liner Kit Kit de Chemise Camisas de los cilindros лайнер комплект	CYL. LINER Zylinderlaufbuchse Chemise Camisas de los cilindros втулка цилиндра	PISTON + RINGS Kolben + Ringe Piston + Segments Pistón Set Поршень и кольца			PISTON SET Kolben Set Set de Piston Pistón Set поршневой	RINGS SET Kolben Set Segments de Piston Anillos Set кольца	PIN Pin Axe Perno Пин			
<b>LS2/LQ9 (364 CID)</b> 8 Cyl 101.6 mm Bore Ø 5,964 cc 5,967 cc		Length: Outside Ø: Flange Ø: flange depth	Length: 56.9 Comp: 33.9 Height: 0		top and 2nd ring lands anodized skirt MOS2 treated	Top: 1.2 2nd: 1.5 3rd: 1st oil: 2.5 2nd oil:	Ø: 23.95 Length: 65.1				
						Reference no.:		Reference no.:	Reference no.:	Reference no.:	O-RING
									19178305	HT-2M5170	
NM-Germany Article no. Artikelnummer/ Modelo Número / статья НОМЕР	NM-Germany Article no.	NM-Germany Article no.	NM-Germany Article no.	NM-Germany Article no.	NM-Germany Article no.	NM-Germany Article no.	NM-Germany Article no.				
			KBSGM80351G	KBGM80351G	KRGM80351G						





**GASOLINE**

ENGINE TYPE Motortyp Type de Moteur Tipo de motor Тип двигателя	LINER KIT Liner Kit Kit de Chemise Camisas de los cilindros лайнер комплект	CYL. LINER Zylinderlaufbuchse Chemise Camisas de los cilindros втулка цилиндра	PISTON + RINGS Kolben + Ringe Piston + Segments Pistón Set Поршень и кольца			PISTON SET Kolben Set Set de Piston Pistón Set поршневой	RINGS SET Kolben Set Segments de Piston Anillos Set кольца	PIN Pin Axe Perno Пин					
<b>138 CID</b> <b>6 Cyl</b> <b>77.79 mm Bore Ø</b> <b>2,261 cc</b>		Length: Outside Ø: Flange Ø: flange depth	Length: Comp: Height:	81.3 46.2 0		Top: 2nd: 3rd: 1st oil: 2nd oil:	2.4 2.4 4.7	Ø: 19.07 Length: 67.1					
									Reference no.:	Reference no.:	Reference no.:	Reference no.:	O-RING
										<b>M-6KRY2075</b>		<b>M-PS993</b>	
NM-Germany Article no. Artikelnummer/ Modelo Número / статья НОМЕР	NM-Germany Article no.	NM-Germany Article no.	NM-Germany Article no.	NM-Germany Article no.	NM-Germany Article no.	NM-Germany Article no.	NM-Germany Article no.						
			<b>KBSHN60357G</b>	<b>KBHN60357G</b>	<b>KRHN60357G</b>								

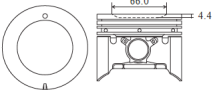

ENGINE TYPE Motortyp Type de Moteur Tipo de motor Тип двигателя	LINER KIT Liner Kit Kit de Chemise Camisas de los cilindros лайнер комплект	CYL. LINER Zylinderlaufbuchse Chemise Camisas de los cilindros втулка цилиндра	PISTON + RINGS Kolben + Ringe Piston + Segments Pistón Set Поршень и кольца			PISTON SET Kolben Set Set de Piston Pistón Set поршневой	RINGS SET Kolben Set Segments de Piston Anillos Set кольца	PIN Pin Axe Perno Пин					
<b>186 CID</b> <b>6 Cyl</b> <b>92.07 mm Bore Ø</b> <b>3,048 cc</b>		Length: Outside Ø: Flange Ø: flange depth	Length: Comp: Height:	81.2 45.3 0		Top: 2nd: 3rd: 1st oil: 2nd oil:	2.0 2.0 4.76	Ø: 22.0 Length: 69.0					
									Reference no.:	Reference no.:	Reference no.:	Reference no.:	O-RING
										<b>M-6KRY3000</b>	<b>7430511</b>	<b>M-PS1357</b>	
NM-Germany Article no. Artikelnummer/ Modelo Número / статья НОМЕР	NM-Germany Article no.	NM-Germany Article no.	NM-Germany Article no.	NM-Germany Article no.	NM-Germany Article no.	NM-Germany Article no.	NM-Germany Article no.						
			<b>KBSHN60358G</b>	<b>KBHN60358G</b>	<b>KRHN60358G</b>								

ENGINE TYPE Motortyp Type de Moteur Tipo de motor Тип двигателя	LINER KIT Liner Kit Kit de Chemise Camisas de los cilindros лайнер комплект	CYL. LINER Zylinderlaufbuchse Chemise Camisas de los cilindros втулка цилиндра	PISTON + RINGS Kolben + Ringe Piston + Segments Pistón Set Поршень и кольца			PISTON SET Kolben Set Set de Piston Pistón Set поршневой	RINGS SET Kolben Set Segments de Piston Anillos Set кольца	PIN Pin Axe Perno Пин					
<b>308</b> <b>8 Cyl</b> <b>101.6 mm Bore Ø</b> <b>5,047 cc</b>		Length: Outside Ø: Flange Ø: flange depth	Length: Comp: Height:	80.2 43.0 0		Top: 2nd: 3rd: 1st oil: 2nd oil:	2.0 2.0 4.75	Ø: 23.5 Length: 73.3					
									Reference no.:	Reference no.:	Reference no.:	Reference no.:	O-RING
NM-Germany Article no. Artikelnummer/ Modelo Número / статья НОМЕР	NM-Germany Article no.	NM-Germany Article no.	NM-Germany Article no.	NM-Germany Article no.	NM-Germany Article no.	NM-Germany Article no.	NM-Germany Article no.						
			<b>KBSHN80359G</b>	<b>KBHN80359G</b>	<b>KRHN80359G</b>								

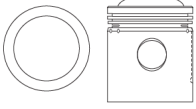

## GASOLINE

ENGINE TYPE	LINER KIT	CYL. LINER	PISTON + RINGS		PISTON SET	RINGS SET	PIN						
Motor typ Type de Moteur Tipo de motor Тип двигателя	Liner Kit Kit de Chemise Camisas de los cilindros лайнер комплект	Zylinderlaufbuchse Chemise Camisas de los cilindros втулка цилиндра	Kolben + Ringe Piston + Segments Pistón Set Поршень и кольца		Kolben Set Set de Piston Pistón Set поршневой	Kolben Set Segments de Piston Anillos Set кольца	Pin Axe Perno Пин						
<b>308</b>		Length: Outside Ø: Flange Ø: flange depth	Length: 80.2 Comp: 42.9 Height: -4.4			Top: 2.0 2nd: 2.0 3rd: 1st oil: 4.75 2nd oil:	Ø: 23.5 Length: 73.3						
									Reference no.:	Reference no.:	Reference no.:	Reference no.:	O-RING
											<b>337807</b>		
<b>8 Cyl</b> <b>101.6 mm Bore Ø</b> <b>5,047 cc</b>													
													
NM-Germany Article no. Artikelnummer/ Modelo Número / статья НОМЕР	NM-Germany Article no.	NM-Germany Article no.	NM-Germany Article no.	NM-Germany Article no.	NM-Germany Article no.	NM-Germany Article no.	NM-Germany Article no.						
			<b>KBSHN80360G</b>	<b>KBHN80360G</b>	<b>KRHN80360G</b>								



**GASOLINE**

ENGINE TYPE Motortyp Type de Moteur Tipo de motor Тип двигателя	LINER KIT Liner Kit Kit de Chemise Camisas de los cilindros лайнер комплект	CYL. LINER Zylinderlaufbuchse Chemise Camisas de los cilindros штулка цилиндра	PISTON + RINGS Kolben + Ringe Piston + Segments Pistón Set Поршень и кольца			PISTON SET Kolben Set Set de Piston Pistón Set поршень	RINGS SET Kolben Set Segments de Piston Anillos Set кольца	PIN Pin Axe Perno Пин
<b>MKIX MKX XK150</b>  6 Cyl 86.99 mm Bore Ø 3,781 cc  		Length:	Length:	105.39		Top:	2.0	Ø: 22.23  Length: 76.0
		Outside Ø:	Comp:	41.89		2nd:	2.0	
		Flange Ø:	Height:	+15.19		3rd:	4.0	
		flange depth				1st oil:	4.0	
			Reference no.:	Reference no.:	Reference no.:	Reference no.:	O-RING	
				<b>A-20615KR M-2791200 N-8752260000</b>		<b>A-R32592K G-0852260000 M-27912N0</b>		
NM-Germany Article no. Artikelnummer/ Modelo Número / статья НОМЕР	NM-Germany Article no.	NM-Germany Article no.	NM-Germany Article no.	NM-Germany Article no.	NM-Germany Article no.	NM-Germany Article no.	NM-Germany Article no.	
			KBSJG60361G	KBJG60361G		KRJG60361G		

**GASOLINE**

ENGINE TYPE Motortyp Type de Moteur Tipo de motor Тип двигателя	LINER KIT Liner Kit Kit de Chemise Camisas de los cilindros лайнер комплект	CYL. LINER Zylinderlaufbuchse Chemise Camisas de los cilindros штулка цилиндра	PISTON + RINGS Kolben + Ringe Piston + Segments Pistón Set Поршень и кольца			PISTON SET Kolben Set Set de Piston Pistón Set поршень	RINGS SET Kolben Set Segments de Piston Anillos Set кольца	PIN Pin Axe Perno Пин
<b>XJ6</b>  6 Cyl 92.07 mm Bore Ø 4,235 cc  		Length:	Length:	80.0		Top:	1.99	Ø: 22.23  Length: 76.0
		Outside Ø:	Comp:	41.5		2nd:	1.99	
		Flange Ø:	Height:	+5.7		3rd:	4.77	
		flange depth				1st oil:	4.77	
			Reference no.:	Reference no.:	Reference no.:	Reference no.:	O-RING	
				<b>A-21380V1 M-6MKRY2956 N-8752400010</b>		<b>A-R39520V1 G-0852400000</b>		
NM-Germany Article no. Artikelnummer/ Modelo Número / статья НОМЕР	NM-Germany Article no.	NM-Germany Article no.	NM-Germany Article no.	NM-Germany Article no.	NM-Germany Article no.	NM-Germany Article no.	NM-Germany Article no.	
			KBSJG60362G	KBJG60362G		KRJG60362G		

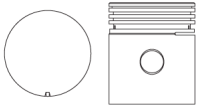
## GASOLINE

ENGINE TYPE Motortyp Type de Moteur Tipo de motor Тип двигателя	LINER KIT Liner Kit Kit de Chemise Camisas de los cilindros лайнер комплект	CYL. LINER Zylinderlaufbuchse Chemise Camisas de los cilindros втулка цилиндра	PISTON + RINGS Kolben + Ringe Piston + Segments Pistón Set Поршень и кольца		PISTON SET Kolben Set Set de Piston Pistón Set поршень	RINGS SET Kolben Set Segments de Piston Anillos Set кольца	PIN Pin Axe Perno Пин					
<b>134 CID</b>  <b>4 Cyl</b> <b>79.38 mm Bore Ø</b> <b>2,200 cc</b>  		Length: Outside Ø: Flange Ø: flange depth	Length: 94.8 Comp: 55.0 Height: +0			Top: 2.38 2nd: 2.38 3rd: 1st oil: 4.76 2nd oil:	Ø: 20.62 Length: 70.5					
								Reference no.:	Reference no.:	Reference no.:	Reference no.:	O-RING
									<b>K-90815500</b>	<b>801476</b>	<b>HT-828 MC-5007</b>	
NM-Germany Article no. Artikelnummer/ Modelo Número / статья НОМЕР	NM-Germany Article no.	NM-Germany Article no.	NM-Germany Article no.	NM-Germany Article no.	NM-Germany Article no.	NM-Germany Article no.	NM-Germany Article no.					
			<b>KBSJE40363G</b>	<b>KBJE40363G</b>	<b>KRJE40363G</b>							

## DIESEL

ENGINE TYPE Motortyp Type de Moteur Tipo de motor Тип двигателя	LINER KIT Liner Kit Kit de Chemise Camisas de los cilindros лайнер комплект	CYL. LINER Zylinderlaufbuchse Chemise Camisas de los cilindros втулка цилиндра	PISTON + RINGS Kolben + Ringe Piston + Segments Pistón Set Поршень и кольца			PISTON SET Kolben Set Set de Piston Pistón Set поршневой	RINGS SET Kolben Set Segments de Piston Anillos Set кольца	PIN Pin Axe Perno Пин				
<b>100 GL</b> <b>4 Cyl</b> <b>65.0 mm Bore Ø</b> <b>903 cc</b>		Length: Outside Ø: Flange Ø: flange depth	Length: 61.2 Comp: 30.7 Height: 0			Top: 1.75 2nd: 2.0 3rd: 2.0 1st oil: 3.94 2nd oil:	Ø: 20.0 Length: 54.0					
								Reference no.:	Reference no.:	Reference no.:	Reference no.:	O-RING
									<b>A-24165</b> <b>K-90451700</b> <b>M-0072000</b> <b>N-8720980000</b>		<b>A-R46550</b> <b>G-0820980000</b> <b>K-800005641000</b> <b>M-00720N0</b>	
NM-Germany Article no. Artikelnummer/ Modelo Número / статья НОМЕР	NM-Germany Article no.	NM-Germany Article no.	NM-Germany Article no.	NM-Germany Article no.	NM-Germany Article no.	NM-Germany Article no.	NM-Germany Article no.					
			<b>KBSLD40364D</b>	<b>KBLD40364D</b>	<b>KRLD40364D</b>							

LADA

## DIESEL

ENGINE TYPE Motortyp Type de Moteur Tipo de motor Тип двигателя	LINER KIT Liner Kit Kit de Chemise Camisas de los cilindros лайнер комплект	CYL. LINER Zylinderlaufbuchse Chemise Camisas de los cilindros втулка цилиндра	PISTON + RINGS Kolben + Ringe Piston + Segments Pistón Set Поршень и кольца			PISTON SET Kolben Set Set de Piston Pistón Set поршневой	RINGS SET Kolben Set Segments de Piston Anillos Set кольца	PIN Pin Axe Perno Пин				
<b>VAZ 2101/BA3 2101</b> <b>VAZ 2103.1/BA3 2103</b> <b>VAZ 2103.2/BA37 2107</b> <b>4 Cyl</b> <b>76.0 mm Bore Ø</b> <b>1,198 cc 1,452 cc</b>	<b>M-4481090</b>	Length: 145.0 Outside Ø: 80.0 Flange Ø: flange depth	Length: 77.0 Comp: 38.0 Height: +0			Top: 1.5 2nd: 2.0 3rd: 2.0 1st oil: 3.95 2nd oil:	Ø: 22.0 Length: 67.0					
								Reference no.:	Reference no.:	Reference no.:	Reference no.:	O-RING
								<b>M-448WV01</b>	<b>K-91315700</b> <b>M-4481000</b> <b>N-8726970000</b>	<b>2101-1004015-80</b>	<b>A-R47260</b> <b>G-0826970000</b> <b>K-800013741000</b> <b>M-00856N0</b> <b>T-50008</b>	
NM-Germany Article no. Artikelnummer/ Modelo Número / статья НОМЕР	NM-Germany Article no.	NM-Germany Article no.	NM-Germany Article no.	NM-Germany Article no.	NM-Germany Article no.	NM-Germany Article no.	NM-Germany Article no.					
	<b>LBS4 0365DP</b>	<b>LBLD40365DP</b>	<b>KBSLD40365D</b>	<b>KBLD40365D</b>	<b>KRLD40365D</b>							

## DIESEL

ENGINE TYPE Motortyp Type de Moteur Tipo de motor Тип двигателя	LINER KIT Liner Kit Kit de Chemise Camisas de los cilindros лайнер комплект	CYL. LINER Zylinderlaufbuchse Chemise Camisas de los cilindros втулка цилиндра	PISTON + RINGS Kolben + Ringe Piston + Segments Pistón Set Поршень и кольца			PISTON SET Kolben Set Set de Piston Pistón Set поршневой	RINGS SET Kolben Set Segments de Piston Anillos Set кольца	PIN Pin Axe Perno Пин				
<b>VAZ 2108</b> <b>VAZ 2108.1</b> <b>4 Cyl</b> <b>76.0 mm Bore Ø</b> <b>1,098 cc 1,288 cc</b>		Length: Outside Ø: Flange Ø: flange depth	Length: 66.0 Comp: 37.9 Height: -5.2			Top: 1.5 2nd: 2.0 3rd: 2.0 1st oil: 3.95 2nd oil:	Ø: 22.0 Length: 66.8					
								Reference no.:	Reference no.:	Reference no.:	Reference no.:	O-RING
									<b>K-93588600</b> <b>M-4481100</b>	<b>2108-1004015</b> <b>2108-1004015-02</b> <b>2108-1004015-04</b>	<b>A-R47260</b> <b>G-0826970000</b> <b>K-800013741000</b> <b>M-00856N0</b> <b>T-50008</b>	
NM-Germany Article no. Artikelnummer/ Modelo Número / статья НОМЕР	NM-Germany Article no.	NM-Germany Article no.	NM-Germany Article no.	NM-Germany Article no.	NM-Germany Article no.	NM-Germany Article no.	NM-Germany Article no.					
			<b>KBSLD40366D</b>	<b>KBLD40366D</b>	<b>KRLD40366D</b>							

**DIESEL**

ENGINE TYPE Motortyp Type de Moteur Tipo de motor Тип двигателя	LINER KIT Liner Kit Kit de Chemise Camisas de los cilindros лайнер комплект	CYL. LINER Zylinderlaufbuchse Chemise Camisas de los cilindros втулка цилиндра	PISTON + RINGS Kolben + Ringe Piston + Segments Pistón Set Поршень и кольца		PISTON SET Kolben Set Set de Piston Pistón Set поршневой	RINGS SET Kolben Set Segments de Piston Anillos Set кольца	PIN Pin Axe Perno Пин
<b>TUD 5</b> 4 Cyl 77.0 mm Bore Ø 1,527 cc		Length: Outside Ø: Flange Ø: flange depth	STD	O/S		Top: 2.0	Ø: 23.0 Length: 60.0
			Length: 66.32	66.32		2nd: 1.75	
			Comp: 40.37	40.1		3rd: 3.0	
			Height: -1.5	-1.5		1st oil: 3.0	
			-2.4	-2.4		2nd oil:	
			<b>Reference no.:</b>	<b>Reference no.:</b>	<b>Reference no.:</b>	<b>Reference no.:</b>	<b>O-RING</b>
				<b>K-94642700</b> <b>M-0390100</b>		<b>A-R49960</b> <b>G-0832580000</b> <b>K-800036541000</b> <b>M-03901N0</b>	
NM-Germany Article no. Artikelnummer/ Modelo Número / статья НОМЕР	NM-Germany Article no.	NM-Germany Article no.	NM-Germany Article no.	NM-Germany Article no.	NM-Germany Article no.	NM-Germany Article no.	NM-Germany Article no.
			<b>KBSLD40367D</b>	<b>KBLD40367D</b>	<b>KRLD40367D</b>		

**DIESEL**

ENGINE TYPE Motortyp Type de Moteur Tipo de motor Тип двигателя	LINER KIT Liner Kit Kit de Chemise Camisas de los cilindros лайнер комплект	CYL. LINER Zylinderlaufbuchse Chemise Camisas de los cilindros втулка цилиндра	PISTON + RINGS Kolben + Ringe Piston + Segments Pistón Set Поршень и кольца		PISTON SET Kolben Set Set de Piston Pistón Set поршневой	RINGS SET Kolben Set Segments de Piston Anillos Set кольца	PIN Pin Axe Perno Пин
<b>VAZ 21011</b> <b>VAZ 2106</b> 4 Cyl 79.0 mm Bore Ø 1,294 cc 1,569 cc	<b>M-4481690</b>	Length: 136.0 Outside Ø: 83.0 Flange Ø: flange depth	Length: 76.8			Top: 1.5	Ø: 22.0 Length: 67.0
			Comp: 37.9			2nd: 2.0	
			Height: -2.0			3rd: 3.95	
						1st oil: 3.95	
						2nd oil:	
			<b>Reference no.:</b>	<b>Reference no.:</b>	<b>Reference no.:</b>	<b>Reference no.:</b>	<b>O-RING</b>
			<b>M-448WV02</b>	<b>K-91317700</b> <b>M-4481600</b>		<b>21011-1000100-00</b> <b>21011-1000100-10</b> <b>K-800013641000</b> <b>K-800013642000</b> <b>M-44815N0</b> <b>T-50009</b>	
NM-Germany Article no. Artikelnummer/ Modelo Número / статья НОМЕР	NM-Germany Article no.	NM-Germany Article no.	NM-Germany Article no.	NM-Germany Article no.	NM-Germany Article no.	NM-Germany Article no.	NM-Germany Article no.
	<b>LBSLD40368DP</b>	<b>LBLD40368DP</b>	<b>KBSLD40368D</b>	<b>KBLD40368D</b>	<b>KRLD40368D</b>		

**DIESEL**

ENGINE TYPE Motortyp Type de Moteur Tipo de motor Тип двигателя	LINER KIT Liner Kit Kit de Chemise Camisas de los cilindros лайнер комплект	CYL. LINER Zylinderlaufbuchse Chemise Camisas de los cilindros втулка цилиндра	PISTON + RINGS Kolben + Ringe Piston + Segments Pistón Set Поршень и кольца		PISTON SET Kolben Set Set de Piston Pistón Set поршневой	RINGS SET Kolben Set Segments de Piston Anillos Set кольца	PIN Pin Axe Perno Пин
<b>VAZ 2105</b> 4 Cyl 79.0 mm Bore Ø 1,294 cc		Length: Outside Ø: Flange Ø: flange depth	Length: 77.0			Top: 1.5	Ø: 22.0 Length: 71.0
			Comp: 38.0			2nd: 2.0	
			Height: -7.0			3rd: 3.95	
						1st oil: 3.95	
						2nd oil:	
			<b>Reference no.:</b>	<b>Reference no.:</b>	<b>Reference no.:</b>	<b>Reference no.:</b>	<b>O-RING</b>
			<b>K-91316600</b> <b>M-4481700</b>	<b>2105-1004015</b> <b>2105-1004015-02</b> <b>2105-1004015-04</b>		<b>21011-1000100-00</b> <b>21011-1000100-10</b> <b>K-800013641000</b> <b>K-800013642000</b> <b>M-44815N0</b> <b>T-50009</b>	
NM-Germany Article no. Artikelnummer/ Modelo Número / статья НОМЕР	NM-Germany Article no.	NM-Germany Article no.	NM-Germany Article no.	NM-Germany Article no.	NM-Germany Article no.	NM-Germany Article no.	NM-Germany Article no.
			<b>KBSLD40369D</b>	<b>KBLD40369D</b>	<b>KRLD40369D</b>		

## DIESEL

ENGINE TYPE Motortyp Type de Moteur Tipo de motor Тип двигателя	LINER KIT Liner Kit Kit de Chemise Camisas de los cilindros лайнер комплект	CYL. LINER Zylinderlaufbuchse Chemise Camisas de los cilindros втулка цилиндра	PISTON + RINGS Kolben + Ringe Piston + Segments Pistón Set Поршень и кольца			PISTON SET Kolben Set Set de Piston Pistón Set поршневой	RINGS SET Kolben Set Segments de Piston Anillos Set кольца	PIN Pin Axe Perno Пин
<b>VAZ 2101</b> <b>VAZ 2106</b> 4 Cyl 79.0 mm Bore Ø 1,294 cc 1,569 cc	<b>M-4481590</b>	Length: 136.0 Outside Ø: 83.0 Flange Ø: flange depth	Length: 76.9 Comp: 38.0 Height: 0			Top: 1.5 2nd: 2.0 3rd: 1st oil: 3.95 2nd oil:	Ø: 22.0 Length: 67.0	
		Reference no.:	Reference no.:	Reference no.:	Reference no.:	O-RING		
		M-448WV02	K-91328600 K-93239600 M-4481500			21011-1000100-00 21011-1000100-10 K-800013641000 K-800013642000 M-44815N0 T-50009		
NM-Germany Article no. Artikelnummer/ Modelo Número / статья НОМЕР	NM-Germany Article no.	NM-Germany Article no.	NM-Germany Article no.	NM-Germany Article no.	NM-Germany Article no.	NM-Germany Article no.	NM-Germany Article no.	
	LBSLD40370DP	LBLD40370DP	KBSLD40370D	KBLD40370D	KRLD40370D			

LADA

## DIESEL

ENGINE TYPE Motortyp Type de Moteur Tipo de motor Тип двигателя	LINER KIT Liner Kit Kit de Chemise Camisas de los cilindros лайнер комплект	CYL. LINER Zylinderlaufbuchse Chemise Camisas de los cilindros втулка цилиндра	PISTON + RINGS Kolben + Ringe Piston + Segments Pistón Set Поршень и кольца			PISTON SET Kolben Set Set de Piston Pistón Set поршневой	RINGS SET Kolben Set Segments de Piston Anillos Set кольца	PIN Pin Axe Perno Пин
<b>VAZ 21011</b> 4 Cyl 79.0 mm Bore Ø 1,294 cc		Length: Outside Ø: Flange Ø: flange depth	Length: 76.9 Comp: 37.9 Height: -1.9			Top: 1.5 2nd: 2.0 3rd: 1st oil: 3.95 2nd oil:	Ø: 22.0 Length: 68.0	
		Reference no.:	Reference no.:	Reference no.:	Reference no.:	O-RING		
				21011-1004015		21011-1000100-00 21011-1000100-10 K-800013641000 K-800013642000 M-44815N0 T-50009		
NM-Germany Article no. Artikelnummer/ Modelo Número / статья НОМЕР	NM-Germany Article no.	NM-Germany Article no.	NM-Germany Article no.	NM-Germany Article no.	NM-Germany Article no.	NM-Germany Article no.	NM-Germany Article no.	
			KBSLD40371D	KBLD40371D	KRLD40371D			

## DIESEL

ENGINE TYPE Motortyp Type de Moteur Tipo de motor Тип двигателя	LINER KIT Liner Kit Kit de Chemise Camisas de los cilindros лайнер комплект	CYL. LINER Zylinderlaufbuchse Chemise Camisas de los cilindros втулка цилиндра	PISTON + RINGS Kolben + Ringe Piston + Segments Pistón Set Поршень и кольца			PISTON SET Kolben Set Set de Piston Pistón Set поршневой	RINGS SET Kolben Set Segments de Piston Anillos Set кольца	PIN Pin Axe Perno Пин
<b>NIVA</b> 4 Cyl 79.0 mm Bore Ø 1,294 cc 1,569 cc		Length: Outside Ø: Flange Ø: flange depth	Length: 77.0 Comp: 38.5 Height: 0			Top: 1.5 2nd: 2.0 3rd: 1st oil: 3.95 2nd oil:	Ø: 22.0 Length: 70.0	
		Reference no.:	Reference no.:	Reference no.:	Reference no.:	O-RING		
						21011-1000100-00 21011-1000100-10 K-800013641000 K-800013642000 M-44815N0 T-50009		
NM-Germany Article no. Artikelnummer/ Modelo Número / статья НОМЕР	NM-Germany Article no.	NM-Germany Article no.	NM-Germany Article no.	NM-Germany Article no.	NM-Germany Article no.	NM-Germany Article no.	NM-Germany Article no.	
			KBSLD40372D	KBLD40372D	KRLD40372D			

**DIESEL**

ENGINE TYPE Motortyp Type de Moteur Tipo de motor Тип двигателя	LINER KIT Liner Kit Kit de Chemise Camisas de los cilindros лайнер комплект	CYL. LINER Zylinderlaufbuchse Chemise Camisas de los cilindros втулка цилиндра	PISTON + RINGS Kolben + Ringe Piston + Segments Pistón Set Поршень и кольца		PISTON SET Kolben Set Set de Piston Pistón Set поршневой	RINGS SET Kolben Set Segments de Piston Anillos Set кольца	PIN Pin Axe Perno Пин					
<b>SAMARA 1500 VAZ 21083</b> 4 Cyl 82.0 mm Bore Ø 1,488 cc		Length: Outside Ø: Flange Ø: flange depth	Length: Comp: Height:	66.0 37.9 -5.6		Top: 1.5 2nd: 2.0 3rd: 4.0 1st oil: 2nd oil:	Ø: 22.0 Length: 64.5					
								Reference no.:	Reference no.:	Reference no.:	Reference no.:	O-RING
									<b>K-93672600 M-4481800 N-8726990000</b>	<b>21083-1004015 21083-1004015-02 21083-1004015-04 21083-1004015-80</b>	<b>G-0826990000 K-800013840000 M-44881N0 T-50020</b>	
NM-Germany Article no. Artikelnummer/ Modelo Número / статья НОМЕР	NM-Germany Article no.	NM-Germany Article no.	NM-Germany Article no.	NM-Germany Article no.	NM-Germany Article no.	NM-Germany Article no.	NM-Germany Article no.					
			<b>KBSLD40373D</b>	<b>KBLD40373D</b>	<b>KRLD40373D</b>							

**DIESEL**

ENGINE TYPE Motortyp Type de Moteur Tipo de motor Тип двигателя	LINER KIT Liner Kit Kit de Chemise Camisas de los cilindros лайнер комплект	CYL. LINER Zylinderlaufbuchse Chemise Camisas de los cilindros втулка цилиндра	PISTON + RINGS Kolben + Ringe Piston + Segments Pistón Set Поршень и кольца		PISTON SET Kolben Set Set de Piston Pistón Set поршневой	RINGS SET Kolben Set Segments de Piston Anillos Set кольца	PIN Pin Axe Perno Пин					
<b>VAZ 21213</b> 4 Cyl 82.0 mm Bore Ø 1,690 cc		Length: Outside Ø: Flange Ø: flange depth	Length: Comp: Height:	64.7 38.0 -6.7		Top: 1.5 2nd: 2.0 3rd: 4.0 1st oil: 2nd oil:	Ø: 22.0 Length: 67.0					
								Reference no.:	Reference no.:	Reference no.:	Reference no.:	O-RING
										<b>21213-1004015 21213-1004015-31 21213-1004015-32</b>	<b>G-0826990000 K-800013840000 M-44881N0 T-50020</b>	
NM-Germany Article no. Artikelnummer/ Modelo Número / статья НОМЕР	NM-Germany Article no.	NM-Germany Article no.	NM-Germany Article no.	NM-Germany Article no.	NM-Germany Article no.	NM-Germany Article no.	NM-Germany Article no.					
			<b>KBSLD40374D</b>	<b>KBLD40374D</b>	<b>KRLD40374D</b>							

**DIESEL**

ENGINE TYPE Motortyp Type de Moteur Tipo de motor Тип двигателя	LINER KIT Liner Kit Kit de Chemise Camisas de los cilindros лайнер комплект	CYL. LINER Zylinderlaufbuchse Chemise Camisas de los cilindros втулка цилиндра	PISTON + RINGS Kolben + Ringe Piston + Segments Pistón Set Поршень и кольца		PISTON SET Kolben Set Set de Piston Pistón Set поршневой	RINGS SET Kolben Set Segments de Piston Anillos Set кольца	PIN Pin Axe Perno Пин						
<b>VAZ 2112</b> 4 Cyl 82.0 mm Bore Ø 1,488 cc		Length: Outside Ø: Flange Ø: flange depth	Length: Comp: Height:	66.9 37.9 +1.0	STD O/S 66.6 37.6 +1.0		Top: 1.5 2nd: 2.0 3rd: 4.0 1st oil: 2nd oil:	Ø: 21.98 Length: 60.0					
									Reference no.:	Reference no.:	Reference no.:	Reference no.:	O-RING
										<b>K-99753600</b>	<b>2112-1004015 2112-1004015-31 2112-1004015-32</b>	<b>G-0826990000 K-800013840000 M-44881N0 T-50020</b>	
NM-Germany Article no. Artikelnummer/ Modelo Número / статья НОМЕР	NM-Germany Article no.	NM-Germany Article no.	NM-Germany Article no.	NM-Germany Article no.	NM-Germany Article no.	NM-Germany Article no.	NM-Germany Article no.						
			<b>KBSLD40375D</b>	<b>KBLD40375D</b>	<b>KRLD40375D</b>								



## DIESEL

ENGINE TYPE Motortyp Type de Moteur Tipo de motor Тип двигателя	LINER KIT Liner Kit Kit de Chemise Camisas de los cilindros лайнер комплект	CYL. LINER Zylinderlaufbuchse Chemise Camisas de los cilindros втулка цилиндра	PISTON + RINGS Kolben + Ringe Piston + Segments Pistón Set Поршень и кольца			PISTON SET Kolben Set Set de Piston Pistón Set поршневой	RINGS SET Kolben Set Segments de Piston Anillos Set кольца	PIN Pin Axe Perno Пин				
<b>VAZ 2110</b> 4 Cyl 82.0 mm Bore Ø 1,488 cc		Length: 64.7 Outside Ø: 38.0 Flange Ø: -6.8 flange depth	Length: 64.7	Comp: 38.0	Height: -6.8	Top: 1.5 2nd: 2.0 3rd: 4.0 1st oil: 2nd oil:	Ø: 21.98 Length: 61.0					
								Reference no.:	Reference no.:	Reference no.:	Reference no.:	O-RING
										2110-1004015 2110-1004015-31 2110-1004015-32	G-0826990000 K-800013840000 M-44881N0 T-50020	
NM-Germany Article no. Artikelnummer/ Modelo Número / статья НОМЕР	NM-Germany Article no.	NM-Germany Article no.	NM-Germany Article no.	NM-Germany Article no.	NM-Germany Article no.	NM-Germany Article no.	NM-Germany Article no.					
			KBSLD40376D	KBLD40376D	KRLD40376D							

LADA



## DIESEL

ENGINE TYPE Motortyp Type de Moteur Tipo de motor Тип двигателя	LINER KIT Liner Kit Kit de Chemise Camisas de los cilindros лайнер комплект	CYL. LINER Zylinderlaufbuchse Chemise Camisas de los cilindros втулка цилиндра	PISTON + RINGS Kolben + Ringe Piston + Segments Pistón Set Поршень и кольца			PISTON SET Kolben Set Set de Piston Pistón Set поршневой	RINGS SET Kolben Set Segments de Piston Anillos Set кольца	PIN Pin Axe Perno Пин				
<b>XUD 9A</b> 4 Cyl 83.0 mm Bore Ø 1,905 cc	(A) K-93648970 M-0392490 consists of (C)  (B) M-0392491 consists of (D)	Length: 153.5 (C) 153.5 (D) Outside Ø: 86.0 86.0 Flange Ø: 89.0 flange depth 4.8	Length: 84.3	Comp: 46.8	Height: -2.2	Top: 2.0 2nd: 2.0 3rd: 3.0 1st oil: 2nd oil:	Ø: 25.0 Length: 72.0					
								Reference no.:	Reference no.:	Reference no.:	Reference no.:	O-RING
								(C) K-89184190 M-039WV21	A-350709 K-93648700 M-0392400 N-8715200010		A-R66390 G-0815200000 K-80003740000 M-03924N0	
NM-Germany Article no. Artikelnummer/ Modelo Número / статья НОМЕР	NM-Germany Article no.	NM-Germany Article no.	NM-Germany Article no.	NM-Germany Article no.	NM-Germany Article no.	NM-Germany Article no.	NM-Germany Article no.					
	LBSLD40377DP (A) LBSLD40377DS (B)	LBLD40377DP (C) LBLD40377DS (D)	KBSLD40377D	KBLD40377D	KRLD40377D							

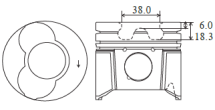

## DIESEL

ENGINE TYPE Motortyp Type de Moteur Tipo de motor Тип двигателя	LINER KIT Liner Kit Kit de Chemise Camisas de los cilindros лайнер комплект	CYL. LINER Zylinderlaufbuchse Chemise Camisas de los cilindros втулка цилиндра	PISTON + RINGS Kolben + Ringe Piston + Segments Pistón Set Поршень и кольца			PISTON SET Kolben Set Set de Piston Pistón Set поршневой	RINGS SET Kolben Set Segments de Piston Anillos Set кольца	PIN Pin Axe Perno Пин					
<b>XUD 9SD TURBO</b> 4 Cyl 83.0 mm Bore Ø 1,905 cc		Length: 46.8 Outside Ø: Flange Ø: flange depth	Length: 79.3	Comp: 46.8	Height: -3.5	STD O/S alfin head anodized skirt MOS2 treated fits tapered con. rod	Top: 3.0 double key-stone 2nd: 2.0 3rd: 3.0 1st oil: 2nd oil:	Ø: 28.0 Length: 68.0					
									Reference no.:	Reference no.:	Reference no.:	Reference no.:	O-RING
											A-A350520 K-94786700 M-0399600 N-8710550000		A-R60140 G-0810550000 M-03996N0
NM-Germany Article no. Artikelnummer/ Modelo Número / статья НОМЕР	NM-Germany Article no.	NM-Germany Article no.	NM-Germany Article no.	NM-Germany Article no.	NM-Germany Article no.	NM-Germany Article no.	NM-Germany Article no.						
			KBSLD40378DA	KBLD40378DA	KRLD40378DA								

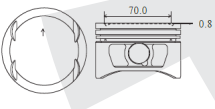

**DIESEL**

ENGINE TYPE	LINER KIT	CYL. LINER	PISTON + RINGS			PISTON SET	RINGS SET	PIN
Motortyp Type de Moteur Tipo de motor Тип двигателя	Liner Kit Kit de Chemise Camisas de los cilindros лайнер комплект	Zylinderlaufbuchse Chemise Camisas de los cilindros втулка цилиндра	Kolben + Ringe Piston + Segments Pistón Set Поршень и кольца			Kolben Set Set de Piston Pistón Set поршеньой	Kolben Set Segments de Piston Anillos Set кольца	Pin Axe Perno Пин
<b>DW10 TD</b> 4 Cyl 85.0 mm Bore Ø 1,997 cc		Length: 155.0 Outside Ø: 89.06 Flange Ø: 91.0 flange depth 4.5	Length: 80.7 Comp: 46.7 Height: -6.0 -18.3			alfin skirt MOS2 treated fits tapered con. rod	Top: 3.5 double key- stone 2nd: 2.0 3rd: 3.0 1st oil: 2nd oil:	Ø: 28.0 Length: 70.0
								
			Reference no.:	Reference no.:	Reference no.:	Reference no.:	O-RING	
				A-A350566 K-99879601 M-0399900 N-8711470000		A-R60410 G-0811470000 K-800045940000 M-03999N0		
NM-Germany Article no. Artikelnummer/ Modelo Número / статья НОМЕР	NM-Germany Article no.	NM-Germany Article no.	NM-Germany Article no.	NM-Germany Article no.	NM-Germany Article no.	NM-Germany Article no.	NM-Germany Article no.	NM-Germany Article no.
	LBSLD40379DSA	LBLD40379DSA	KBSLD40379DA	KBLD40379DA	KRLD40379DA			

**DIESEL**



ENGINE TYPE	LINER KIT	CYL. LINER	PISTON + RINGS			PISTON SET	RINGS SET	PIN
Motortyp Type de Moteur Tipo de motor Тип двигателя	Liner Kit Kit de Chemise Camisas de los cilindros лайнер комплект	Zylinderlaufbuchse Chemise Camisas de los cilindros втулка цилиндра	Kolben + Ringe Piston + Segments Pistón Set Поршень и кольца			Kolben Set Set de Piston Pistón Set поршеньой	Kolben Set Segments de Piston Anillos Set кольца	Pin Axe Perno Пин
<b>C 2.0 XE</b> 4 Cyl 86.0 mm Bore Ø 1,998 cc		Length: Outside Ø: Flange Ø: flange depth	Length: 55.4 Comp: 30.4 Height: -0.8				Top: 1.5 2nd: 1.5 3rd: 3.0 1st oil: 2nd oil:	Ø: 21.0 Length: 61.5
								
			Reference no.:	Reference no.:	Reference no.:	Reference no.:	O-RING	
				A-24024 K-91023700 M-0117700 N-8730680010		A-R43290 G-0830680000 K-800021240000 M-01158N0		
NM-Germany Article no. Artikelnummer/ Modelo Número / статья НОМЕР	NM-Germany Article no.	NM-Germany Article no.	NM-Germany Article no.	NM-Germany Article no.	NM-Germany Article no.	NM-Germany Article no.	NM-Germany Article no.	NM-Germany Article no.
			KBSLD40380D	KBLD40380D	KRLD40380D			

## DIESEL

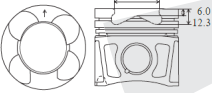

ENGINE TYPE Motortyp Type de Moteur Tipo de motor Тип двигателя	LINER KIT Liner Kit Kit de Chemise Camisas de los cilindros лайнер комплект	CYL. LINER Zylinderlaufbuchse Chemise Camisas de los cilindros втулка цилиндра	PISTON + RINGS Kolben + Ringe Piston + Segments Pistón Set Поршень и кольца			PISTON SET Kolben Set Set de Piston Pistón Set поршневой	RINGS SET Kolben Set Segments de Piston Anillos Set кольца	PIN Pin Axe Perno Пин		
<b>188 A9</b> <b>199 A2</b> 4 Cyl 69.6 mm Bore Ø 1,251 cc 		Length: Outside Ø: Flange Ø: flange depth	Length: 63.43 Comp: 40.43 Height: -5.5 -12.4		alfin skirt MOS2 treated fits tapered con. rod	Top: 2.0 2nd: 1.5 3rd: 1st oil: 2.0 2nd oil:	Ø: 23.0 Length: 56.5			
						Reference no.:	Reference no.:	Reference no.:	Reference no.:	O-RING
							<b>A-A354085</b> <b>K-40213600</b> <b>M-0100400</b> <b>N-8713760000</b>			<b>A-R66830</b> <b>G-0813760000</b> <b>K-800056240000</b> <b>M-01004N0</b>
NM-Germany Article no. Artikelnummer/ Modelo Número / статья НОМЕР	NM-Germany Article no.	NM-Germany Article no.	NM-Germany Article no.	NM-Germany Article no.	NM-Germany Article no.	NM-Germany Article no.	NM-Germany Article no.			
			KBSLC40381DA	KBLC40381DA	KRLC40381DA					

LANCIA

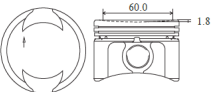

## DIESEL

ENGINE TYPE Motortyp Type de Moteur Tipo de motor Тип двигателя	LINER KIT Liner Kit Kit de Chemise Camisas de los cilindros лайнер комплект	CYL. LINER Zylinderlaufbuchse Chemise Camisas de los cilindros втулка цилиндра	PISTON + RINGS Kolben + Ringe Piston + Segments Pistón Set Поршень и кольца			PISTON SET Kolben Set Set de Piston Pistón Set поршневой	RINGS SET Kolben Set Segments de Piston Anillos Set кольца	PIN Pin Axe Perno Пин		
<b>199 A3</b> 4 Cyl 69.6 mm Bore Ø 1,248 cc 		Length: Outside Ø: Flange Ø: flange depth	Length: 62.5 Comp: 40.5 Height: -6.0 -12.3		alfin and with oil gallery skirt MOS2 treated fits tapered con. rod	Top: 2.0 2nd: 1.5 3rd: 1st oil: 2.0 2nd oil:	Ø: 23.0 Length: 57.0			
						Reference no.:	Reference no.:	Reference no.:	Reference no.:	O-RING
							<b>K-40659600</b> <b>N-8742560000</b>			<b>A-R66830</b> <b>G-0813760000</b> <b>K-800056240000</b> <b>M-01004N0</b>
NM-Germany Article no. Artikelnummer/ Modelo Número / статья НОМЕР	NM-Germany Article no.	NM-Germany Article no.	NM-Germany Article no.	NM-Germany Article no.	NM-Germany Article no.	NM-Germany Article no.	NM-Germany Article no.			
			KBSLC40382DB	KBLC40382DB	KRLC40382DB					



## GASOLINE

ENGINE TYPE Motortyp Type de Moteur Tipo de motor Тип двигателя	LINER KIT Liner Kit Kit de Chemise Camisas de los cilindros лайнер комплект	CYL. LINER Zylinderlaufbuchse Chemise Camisas de los cilindros втулка цилиндра	PISTON + RINGS Kolben + Ringe Piston + Segments Pistón Set Поршень и кольца			PISTON SET Kolben Set Set de Piston Pistón Set поршневой	RINGS SET Kolben Set Segments de Piston Anillos Set кольца	PIN Pin Axe Perno Пин		
<b>156 C.046</b> <b>176 B2</b> 4 Cyl 70.0 mm Bore Ø 1,108 cc 		Length: 116.0 Outside Ø: 72.98 Flange Ø: flange depth	Length: 50.0 Comp: 30.0 Height: -0.6 -1.8			Top: 1.2 2nd: 1.2 3rd: 1st oil: 2.5 2nd oil:	Ø: 18.0 Length: 53.0			
						Reference no.:	Reference no.:	Reference no.:	Reference no.:	O-RING
							<b>A-SU4320</b>	<b>A-24231</b> <b>K-94910600</b> <b>K-94910700</b> <b>M-0093600</b> <b>N-8714230000</b>		<b>A-R48480</b> <b>G-0814230000</b> <b>K-800051340000</b> <b>M-00936N0</b>
NM-Germany Article no. Artikelnummer/ Modelo Número / статья НОМЕР	NM-Germany Article no.	NM-Germany Article no.	NM-Germany Article no.	NM-Germany Article no.	NM-Germany Article no.	NM-Germany Article no.	NM-Germany Article no.			
	LBSLC40383GP	LBLC40383GP	KBSLC40383G	KBLC40383G	KRLC40383G					



**GASOLINE**

ENGINE TYPE Motortyp Type de Moteur Tipo de motor Тип двигателя	LINER KIT Liner Kit Kit de Chemise Camisas de los cilindros лайнер комплект	CYL. LINER Zylinderlaufbuchse Chemise Camisas de los cilindros втулка цилиндра	PISTON + RINGS Kolben + Ringe Piston + Segments Pistón Set Поршень и кольца			PISTON SET Kolben Set Set de Piston Pistón Set поршень	RINGS SET Kolben Set Segments de Piston Anillos Set кольца	PIN Pin Axe Perno Пин
<b>132 AB</b> 4 Cyl 80.0 mm Bore Ø 1,592 cc 		Length:		Length:	81.8	Top:	1.5	Ø: 22.0 Length: 68.0
		Outside Ø:		Comp:	37.7	2nd:	2.0	
		Flange Ø:		Height:	4.6	3rd:	3.95	
		flange depth				1st oil:		
			<b>Reference no.:</b>	<b>Reference no.:</b>	<b>Reference no.:</b>	<b>Reference no.:</b>	<b>O-RING</b>	
				<b>K-92472600</b> <b>M-0075600</b>		<b>A-R47750</b> <b>G-0820310000</b> <b>K-800006141000</b> <b>M-00765N0</b>		
NM-Germany Article no. Artikelnummer/ Modelo Número / статья НОМЕР	NM-Germany Article no.	NM-Germany Article no.	NM-Germany Article no.	NM-Germany Article no.	NM-Germany Article no.	NM-Germany Article no.	NM-Germany Article no.	NM-Germany Article no.
			<b>KBSLC40384G</b>	<b>KBLC40384G</b>	<b>KRLC40384G</b>			

**GASOLINE**

ENGINE TYPE Motortyp Type de Moteur Tipo de motor Тип двигателя	LINER KIT Liner Kit Kit de Chemise Camisas de los cilindros лайнер комплект	CYL. LINER Zylinderlaufbuchse Chemise Camisas de los cilindros втулка цилиндра	PISTON + RINGS Kolben + Ringe Piston + Segments Pistón Set Поршень и кольца			PISTON SET Kolben Set Set de Piston Pistón Set поршень	RINGS SET Kolben Set Segments de Piston Anillos Set кольца	PIN Pin Axe Perno Пин
<b>160 A1</b> <b>836 A4</b> 4 Cyl 80.5 mm Bore Ø 1,372 cc 		Length:		Length:	72.8	Top:	1.5	Ø: 22.0 Length: 58.0
		Outside Ø:		Comp:	33.3	2nd:	1.75	
		Flange Ø:		Height:	-2.4	3rd:	3.0	
		flange depth				1st oil:		
			<b>Reference no.:</b>	<b>Reference no.:</b>	<b>Reference no.:</b>	<b>Reference no.:</b>	<b>O-RING</b>	
				<b>A-24204</b> <b>K-92292600</b> <b>M-0087600</b>		<b>A-R46940</b> <b>G-0878360000</b>		
NM-Germany Article no. Artikelnummer/ Modelo Número / статья НОМЕР	NM-Germany Article no.	NM-Germany Article no.	NM-Germany Article no.	NM-Germany Article no.	NM-Germany Article no.	NM-Germany Article no.	NM-Germany Article no.	NM-Germany Article no.
			<b>KBSLC40385G</b>	<b>KBLC40385G</b>	<b>KRLC40385G</b>			

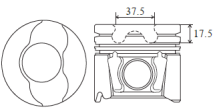
**DIESEL**

ENGINE TYPE Motortyp Type de Moteur Tipo de motor Тип двигателя	LINER KIT Liner Kit Kit de Chemise Camisas de los cilindros лайнер комплект	CYL. LINER Zylinderlaufbuchse Chemise Camisas de los cilindros втулка цилиндра	PISTON + RINGS Kolben + Ringe Piston + Segments Pistón Set Поршень и кольца			PISTON SET Kolben Set Set de Piston Pistón Set поршень	RINGS SET Kolben Set Segments de Piston Anillos Set кольца	PIN Pin Axe Perno Пин	
<b>839 A5</b> <b>AR 32302/M 722</b> <b>BT.19</b> 4/5 Cyl 82.0 mm Bore Ø 2,387 cc 		Length:	155.0	Length:	73.25	alfin skirt MOS2 treated pin bushing inserted	Top:	3.0	Ø: 25.99 Length: 61.0
		Outside Ø:	85.0	Comp:	47.25		double key-stone		
		Flange Ø:	88.0	Height:	-1.4		2nd:	2.0	
		flange depth	4.5		-17.5	3rd:	3.0		
			<b>Reference no.:</b>	<b>Reference no.:</b>	<b>Reference no.:</b>	<b>Reference no.:</b>	<b>O-RING</b>		
			<b>G-1402896000</b>	<b>A-A350534</b> <b>K-94966600</b> <b>M-0633700</b> <b>N-8710800000</b>		<b>A-R49870</b> <b>G-0810800000</b>			
NM-Germany Article no. Artikelnummer/ Modelo Número / статья НОМЕР	NM-Germany Article no.	NM-Germany Article no.	NM-Germany Article no.	NM-Germany Article no.	NM-Germany Article no.	NM-Germany Article no.	NM-Germany Article no.	NM-Germany Article no.	
	<b>LBSLC450386DSA</b>	<b>LBLC450386DSA</b>	<b>KBSLC450386DA</b>	<b>KBLC450386DA</b>	<b>KRLC450386DA</b>				

## DIESEL

ENGINE TYPE Motortyp Type de Moteur Tipo de motor Тип двигателя	LINER KIT Liner Kit Kit de Chemise Camisas de los cilindros лайнер комплект	CYL. LINER Zylinderlaufbuchse Chemise Camisas de los cilindros втулка цилиндра	PISTON + RINGS Kolben + Ringe Piston + Segments Pistón Set Поршень и кольца	PISTON SET Kolben Set Set de Piston Pistón Set поршневой	RINGS SET Kolben Set Segments de Piston Anillos Set кольца	PIN Pin Axe Perno Пин						
<b>AR 37101</b> <b>839 A6/841 C</b> 4/5 Cyl 82.0 mm Bore Ø 1,910 cc 2,387 cc		Length: 155.0 Outside Ø: 85.0 Flange Ø: 88.0 flange depth 4.5	Length: 72.5 Comp: 46.5 Height: -6.0 -17.5	alfin skirt MOS2 treated pin bushing inserted	Top: 2.0 2nd: 2.0 3rd: 2.0 1st oil: 2.0 2nd oil:	Ø: 25.988 Length: 61.0						
		Reference no.:			Reference no.:		Reference no.:		Reference no.:		O-RING	
		G-1402896000			A-A354067 K-40218600 K-99724600 M-0101500 N-8712400030		0 623 552 5 623 221/2 5 518 1762/3/4 5 518 1765/6/7 7 171 8118/9 7 173 4218/9		A-R60580 A-R67925 G-0812400000 G-0814610000 K-800072610000 K-800073040000 M-00981N0			
NM-Germany Article no. Artikelnummer/ Modelo Número / статья НОМЕР	NM-Germany Article no.	NM-Germany Article no.	NM-Germany Article no.	NM-Germany Article no.	NM-Germany Article no.	NM-Germany Article no.						
	LBSLC450387DSA	LBLC450387DSA	KBSLC450387DA	KBLC450387DA	KRLC450387DA							



## DIESEL

ENGINE TYPE Motortyp Type de Moteur Tipo de motor Тип двигателя	LINER KIT Liner Kit Kit de Chemise Camisas de los cilindros лайнер комплект	CYL. LINER Zylinderlaufbuchse Chemise Camisas de los cilindros втулка цилиндра	PISTON + RINGS Kolben + Ringe Piston + Segments Pistón Set Поршень и кольца	PISTON SET Kolben Set Set de Piston Pistón Set поршневой	RINGS SET Kolben Set Segments de Piston Anillos Set кольца	PIN Pin Axe Perno Пин						
<b>192 B1/192 A5</b> <b>937 A4/937 A5</b> <b>841 G/841 M/841</b> <b>N M 729 AT.19/24</b> 4/5 Cyl 82.0 mm Bore Ø 1,910 cc 2,387 cc		Length: 155.0 Outside Ø: 85.0 Flange Ø: 88.0 flange depth 4.5	Length: 73.5 Comp: 46.5 Height: -0.7 -15.4	alfin and with oil gallery skirt MOS2 treated pin bushing inserted	Top: 2.0 2nd: 2.0 3rd: 2.0 1st oil: 2.0 2nd oil:	Ø: 26.0 Length: 61.0						
		Reference no.:			Reference no.:		Reference no.:		Reference no.:		O-RING	
		G-1402896000			A-A354086 K-40660600 M-0101600 N-8714610000				A-R60580 A-R67925 G-0812400000 G-0814610000 K-800072610000 K-800073040000 M-00981N0			
NM-Germany Article no. Artikelnummer/ Modelo Número / статья НОМЕР	NM-Germany Article no.	NM-Germany Article no.	NM-Germany Article no.	NM-Germany Article no.	NM-Germany Article no.	NM-Germany Article no.						
	LBSLC450388DSB	LBLC450388DSB	KBSLC450388DB	KBLC450388DB	KRLC450388DB							

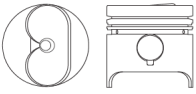

## GASOLINE

ENGINE TYPE Motortyp Type de Moteur Tipo de motor Тип двигателя	LINER KIT Liner Kit Kit de Chemise Camisas de los cilindros лайнер комплект	CYL. LINER Zylinderlaufbuchse Chemise Camisas de los cilindros втулка цилиндра	PISTON + RINGS Kolben + Ringe Piston + Segments Pistón Set Поршень и кольца	PISTON SET Kolben Set Set de Piston Pistón Set поршневой	RINGS SET Kolben Set Segments de Piston Anillos Set кольца	PIN Pin Axe Perno Пин						
<b>182 A1</b> <b>838 A1</b> 5 Cyl 82.0 mm Bore Ø 1,998 cc		Length: 155.0 Outside Ø: 85.0 Flange Ø: 88.0 flange depth 4.5	Length: 57.7 Comp: 32.9 Height: 0.8	skirt MOS2 treated	Top: 1.5 2nd: 1.5 3rd: 3.0 1st oil: 3.0 2nd oil:	Ø: 20.0 Length: 52.0						
		Reference no.:			Reference no.:		Reference no.:		Reference no.:		O-RING	
					A-24029 M-0094400 N-8778700000				M-00944N0 M-06303N0			
NM-Germany Article no. Artikelnummer/ Modelo Número / статья НОМЕР	NM-Germany Article no.	NM-Germany Article no.	NM-Germany Article no.	NM-Germany Article no.	NM-Germany Article no.	NM-Germany Article no.						
			KBSLC50389G	KBLC50389G	KRLC50389G							



**DIESEL**

ENGINE TYPE Motortyp Type de Moteur Tipo de motor Тип двигателя	LINER KIT Liner Kit Kit de Chemise Camisas de los cilindros лайнер комплект	CYL. LINER Zylinderlaufbuchse Chemise Camisas de los cilindros втулка цилиндра	PISTON + RINGS Kolben + Ringe Piston + Segments Pistón Set Поршень и кольца		PISTON SET Kolben Set Set de Piston Pistón Set поршневой	RINGS SET Kolben Set Segments de Piston Anillos Set кольца	PIN Pin Axe Perno Пин
<b>149 A1</b> 4 Cyl 82.6 mm Bore Ø 1,929 cc 	<b>(A)</b> <b>M-0072890</b> consists of (C)  <b>(B)</b> <b>M-0072892</b> consists of (D)	(C)	(D)	Length: 84.1	alfin head anodized	Top: 2.5	Ø: 25.0 Length: 69.5
		Length: 154.0	154.2	Comp: 42.6		double keystone	
		Outside Ø: 86.0	86.1	Height: +2.3		2nd: 2.0	
		Flange Ø: 89.0				3rd: 4.0	
		flange depth	4.6			1st oil:	
						2nd oil:	
		<b>Reference no.:</b>	<b>Reference no.:</b>	<b>Reference no.:</b>	<b>Reference no.:</b>	<b>O-RING</b>	
		<b>(C)</b> G-1401473000 K-89386190 M-007WV44		<b>A-A350668</b> M-0072800 N-8778230000		<b>A-R47120</b> G-0878230000 M-00728N0	
		<b>(D)</b> M-007WV66					
NM-Germany Article no. Artikelnummer/ Modelo Número / статья НОМЕР	NM-Germany Article no.	NM-Germany Article no.	NM-Germany Article no.	NM-Germany Article no.	NM-Germany Article no.	NM-Germany Article no.	NM-Germany Article no.
	LBSLC40390DPA (A) LBSLC40390DSA (B)	LBLC40390DP (A) LBLC40390DS (B)	KBSLC40390DA	KBLC40390DA	KRLC40390D		

**GASOLINE**

ENGINE TYPE Motortyp Type de Moteur Tipo de motor Тип двигателя	LINER KIT Liner Kit Kit de Chemise Camisas de los cilindros лайнер комплект	CYL. LINER Zylinderlaufbuchse Chemise Camisas de los cilindros втулка цилиндра	PISTON + RINGS Kolben + Ringe Piston + Segments Pistón Set Поршень и кольца		PISTON SET Kolben Set Set de Piston Pistón Set поршневой	RINGS SET Kolben Set Segments de Piston Anillos Set кольца	PIN Pin Axe Perno Пин
<b>828 B1</b> <b>828 B4</b> 4 Cyl 84.0 mm Bore Ø 1,995 cc 				Length: 77.9		Top: 1.5	Ø: 22.0 Length: 69.0
		Length: 154.0	154.2	Comp: 38.4		2nd: 2.0	
		Outside Ø: 86.0	86.1	Height: -4.5		3rd: 3.95	
		Flange Ø: 89.0				1st oil: 3.95	
		flange depth	-5.1			2nd oil:	
		<b>Reference no.:</b>	<b>Reference no.:</b>	<b>Reference no.:</b>	<b>Reference no.:</b>	<b>O-RING</b>	
				<b>K-93279600</b> M-0086600		<b>A-R46970</b> G-0821530010 K-800006541000 M-00865N0	
NM-Germany Article no. Artikelnummer/ Modelo Número / статья НОМЕР	NM-Germany Article no.	NM-Germany Article no.	NM-Germany Article no.	NM-Germany Article no.	NM-Germany Article no.	NM-Germany Article no.	NM-Germany Article no.
			KBSLC40391G	KBLC40391G	KRLC40391G		

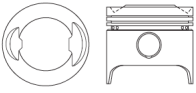
**GASOLINE**

ENGINE TYPE Motortyp Type de Moteur Tipo de motor Тип двигателя	LINER KIT Liner Kit Kit de Chemise Camisas de los cilindros лайнер комплект	CYL. LINER Zylinderlaufbuchse Chemise Camisas de los cilindros втулка цилиндра	PISTON + RINGS Kolben + Ringe Piston + Segments Pistón Set Поршень и кольца		PISTON SET Kolben Set Set de Piston Pistón Set поршневой	RINGS SET Kolben Set Segments de Piston Anillos Set кольца	PIN Pin Axe Perno Пин
<b>132 AB/B/BB C1</b> 4 Cyl 84.0 mm Bore Ø 1,756 cc 				Length: 79.9		Top: 1.5	Ø: 22.0 Length: 69.0
		Length: 154.0	154.2	Comp: 38.4		2nd: 2.0	
		Outside Ø: 86.0	86.1	Height: 2.0		3rd: 3.95	
		Flange Ø: 89.0				1st oil: 3.95	
		flange depth				2nd oil:	
		<b>Reference no.:</b>	<b>Reference no.:</b>	<b>Reference no.:</b>	<b>Reference no.:</b>	<b>O-RING</b>	
				<b>K-92425600</b> M-0077500		<b>A-R46970</b> G-0821530010 K-800006541000 M-00865N0	
NM-Germany Article no. Artikelnummer/ Modelo Número / статья НОМЕР	NM-Germany Article no.	NM-Germany Article no.	NM-Germany Article no.	NM-Germany Article no.	NM-Germany Article no.	NM-Germany Article no.	NM-Germany Article no.
			KBSLC40392G	KBLC40392G	KRLC40392G		

**DIESEL**



ENGINE TYPE Motortyp Type de Moteur Tipo de motor Тип двигателя	LINER KIT Liner Kit Kit de Chemise Camisas de los cilindros лайнер комплект	CYL. LINER Zylinderlaufbuchse Chemise Camisas de los cilindros втулка цилиндра	PISTON + RINGS Kolben + Ringe Piston + Segments Pistón Set Поршень и кольца	PISTON SET Kolben Set Set de Piston Pistón Set поршневой	RINGS SET Kolben Set Segments de Piston Anillos Set кольца	PIN Pin Axe Perno Пин
<b>DW10 ATED</b> <b>DW10 TD RHZ</b> 4 Cyl 85.0 mm Bore Ø 1,997 cc		Length: 155.0 Outside Ø: 89.06 Flange Ø: 91.0 flange depth 4.5	Length: 80.7 Comp: 46.7 Height: -6.0 -18.3	alfin skirt MOS2 treated fits tapered con. rod	Top: 3.5 double key-stone 2nd: 2.0 3rd: 3.0 1st oil: 2nd oil:	Ø: 28.0 Length: 70.0
		Reference no.:	Reference no.:	Reference no.:	Reference no.:	O-RING
			<b>A-A350566</b> <b>K-99879601</b> <b>M-0399900</b> <b>N-8711470000</b>			<b>A-R60410</b> <b>G-0811470000</b> <b>K-800045940000</b> <b>M-03999N0</b>
NM-Germany Article no. Artikelnummer/ Modelo Número / статья НОМЕР	NM-Germany Article no.	NM-Germany Article no.	NM-Germany Article no.	NM-Germany Article no.	NM-Germany Article no.	NM-Germany Article no.
	LBSLC40393DSA	LBLC40393DSA	KBSLC40393DA	KBLC40393DA	KRLC40393DA	

LANCIA



**DIESEL**

ENGINE TYPE Motortyp Type de Moteur Tipo de motor Тип двигателя	LINER KIT Liner Kit Kit de Chemise Camisas de los cilindros лайнер комплект	CYL. LINER Zylinderlaufbuchse Chemise Camisas de los cilindros втулка цилиндра	PISTON + RINGS Kolben + Ringe Piston + Segments Pistón Set Поршень и кольца	PISTON SET Kolben Set Set de Piston Pistón Set поршневой	RINGS SET Kolben Set Segments de Piston Anillos Set кольца	PIN Pin Axe Perno Пин
<b>DW10 BTED4</b> 4 Cyl 85.0 mm Bore Ø 1,997 cc	<b>K-99700600</b> <b>A-R60410</b> <b>G-0811470000</b> <b>K-800045940000</b> <b>M-03999N0</b>	Length: 165.0 Outside Ø: 89.06 Flange Ø: 91.0 flange depth 4.5	Length: 80.7 Comp: 46.7 Height: -4.7 -15.4	alfin and with oil gallery skirt MOS2 treated fits tapered con. rod	Top: 3.5 double key-stone 2nd: 2.0 3rd: 3.0 1st oil: 2nd oil:	Ø: 28.0 Length: 70.0
		Reference no.:	Reference no.:	Reference no.:	Reference no.:	O-RING
NM-Germany Article no. Artikelnummer/ Modelo Número / статья НОМЕР	NM-Germany Article no.	NM-Germany Article no.	NM-Germany Article no.	NM-Germany Article no.	NM-Germany Article no.	NM-Germany Article no.
	LBSLC40394DSB	LBLC40394DSB	KBSLC40394DB	KBLC40394DB	KRLC40394DB	



**DIESEL**

ENGINE TYPE	LINER KIT	CYL. LINER	PISTON + RINGS		PISTON SET	RINGS SET	PIN
Motortyp Type de Moteur Tipo de motor Тип двигателя	Liner Kit Kit de Chemise Camisas de los cilindros лайнер комплект	Zylinderlaufbuchse Chemise Camisas de los cilindros втулка цилиндра	Kolben + Ringe Piston + Segments Pistón Set Поршень и кольца		Kolben Set Set de Piston Pistón Set поршневой	Kolben Set Segments de Piston Anillos Set кольца	Pin Axe Perno Пин
<b>TUD 5</b> 4 Cyl 77.0 mm Bore Ø 1,527 cc		Length: 66.32 Outside Ø: 40.37 Flange Ø: -1.5 flange depth: -2.4	STD 66.32 Comp: 40.1 Height: -1.5	O/S 66.32 40.1 -1.5		Top: 2.0 2nd: 1.75 3rd: 3.0 1st oil: 2nd oil:	Ø: 23.0 Length: 60.0
		Reference no.:	Reference no.:	Reference no.:	Reference no.:	O-RING	
			<b>K-94642700</b> <b>M-0390100</b>			<b>A-R49960</b> <b>G-0832580000</b> <b>K-800036541000</b> <b>M-03901N0</b>	
NM-Germany Article no. Artikelnummer/ Modelo Número / статья НОМЕР	NM-Germany Article no.	NM-Germany Article no.	NM-Germany Article no.	NM-Germany Article no.	NM-Germany Article no.	NM-Germany Article no.	NM-Germany Article no.
			<b>KBSLR40395D</b>	<b>KBLR40395D</b>	<b>KRLR40395D</b>		

**DIESEL**

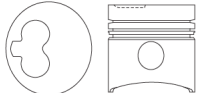

ENGINE TYPE	LINER KIT	CYL. LINER	PISTON + RINGS		PISTON SET	RINGS SET	PIN
Motortyp Type de Moteur Tipo de motor Тип двигателя	Liner Kit Kit de Chemise Camisas de los cilindros лайнер комплект	Zylinderlaufbuchse Chemise Camisas de los cilindros втулка цилиндра	Kolben + Ringe Piston + Segments Pistón Set Поршень и кольца		Kolben Set Set de Piston Pistón Set поршневой	Kolben Set Segments de Piston Anillos Set кольца	Pin Axe Perno Пин
<b>2.5 6T TURBO</b> 6 Cyl 80.0 mm Bore Ø 2,498 cc		Length: 143.0 Outside Ø: 84.0 Flange Ø: 85.0 flange depth: 4.8	Length: 62.4 Comp: 39.4 Height: -2.5		alfin and with oil gallery top ring land and skirt MOS2 treated	Top: 3.0 double key- stone 2nd: 1.75 3rd: 3.0 1st oil: 2nd oil:	Ø: 27.0 Length: 63.0
		Reference no.:	Reference no.:	Reference no.:	Reference no.:	O-RING	
			<b>K-94347600</b> <b>M-0826200</b> <b>N-8770450000</b>			<b>A-R49900</b> <b>G-0870450000</b> <b>K-800030120000</b> <b>M-08262N0</b>	
NM-Germany Article no. Artikelnummer/ Modelo Número / статья НОМЕР	NM-Germany Article no.	NM-Germany Article no.	NM-Germany Article no.	NM-Germany Article no.	NM-Germany Article no.	NM-Germany Article no.	NM-Germany Article no.
	<b>LBSLR60396DSB</b>	<b>LBLR60396DSB</b>	<b>KBSLR60396DB</b>	<b>KBLR60396DB</b>	<b>KRLR60396DB</b>		



**DIESEL**

ENGINE TYPE	LINER KIT	CYL. LINER	PISTON + RINGS		PISTON SET	RINGS SET	PIN
Motortyp Type de Moteur Tipo de motor Тип двигателя	Liner Kit Kit de Chemise Camisas de los cilindros лайнер комплект	Zylinderlaufbuchse Chemise Camisas de los cilindros втулка цилиндра	Kolben + Ringe Piston + Segments Pistón Set Поршень и кольца		Kolben Set Set de Piston Pistón Set поршневой	Kolben Set Segments de Piston Anillos Set кольца	Pin Axe Perno Пин
<b>XUD 7TE</b> 4 Cyl 80.0 mm Bore Ø 1,769 cc	<b>K-90354960</b> <b>M-0397390</b>	Length: 154.0 Outside Ø: 83.0 Flange Ø: 86.0 flange depth: 4.5	Length: 84.5 Comp: 46.8 Height: -1.85		alfin head anodized	Top: 3.0 double key- stone 2nd: 2.0 3rd: 3.0 1st oil: 2nd oil:	Ø: 28.0 Length: 68.0
		Reference no.:	Reference no.:	Reference no.:	Reference no.:	O-RING	
		<b>G-1402483000</b> <b>K-89316190</b> <b>M-039WV23</b>	<b>A-A350536</b> <b>K-90354600</b> <b>M-0397300</b> <b>N-8732360000</b>			<b>A-R49910</b> <b>G-0832360000</b> <b>K-800003340000</b> <b>M-03973N0</b>	
NM-Germany Article no. Artikelnummer/ Modelo Número / статья НОМЕР	NM-Germany Article no.	NM-Germany Article no.	NM-Germany Article no.	NM-Germany Article no.	NM-Germany Article no.	NM-Germany Article no.	NM-Germany Article no.
	<b>LBSLR40397DSA</b>	<b>LBLR40397DSA</b>	<b>KBSLR40397DA</b>	<b>KBLR40397DA</b>	<b>KRLR40397DA</b>		

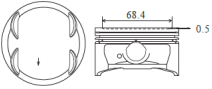

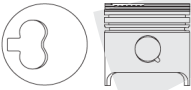

## GASOLINE

ENGINE TYPE Motortyp Type de Moteur Tipo de motor Тип двигателя	LINER KIT Liner Kit Kit de Chemise Camisas de los cilindros лайнер комплект	CYL. LINER Zylinderlaufbuchse Chemise Camisas de los cilindros втулка цилиндра	PISTON + RINGS Kolben + Ringe Piston + Segments Pistón Set Поршень и кольца			PISTON SET Kolben Set Set de Piston Pistón Set поршневой	RINGS SET Kolben Set Segments de Piston Anillos Set кольца	PIN Pin Axe Perno Пин			
<b>16 K4F</b> <b>18 K4F</b> 4 Cyl 80.0 mm Bore Ø 1,588 cc 1,796 cc 	<b>A-SA2415</b> <b>N-8852270000</b>	Length: 129.5 Outside Ø: 84.1 Flange Ø: 87.5 collar depth: 50.05	Length: 45.7 Comp: 22.7 Height: -0.5	fits tapered con. rod		Top: 1.0 2nd: 1.2 3rd: 2.0 1st oil: 2.0 2nd oil:	Ø: 18.0 Length: 52.4				
		Reference no.:		Reference no.:		Reference no.:		Reference no.:		O-RING	
		<b>A-SJ4308</b> <b>G-1471002000</b>		<b>A-24083</b> <b>N-8752270000</b>				<b>A-R49540</b> <b>G-0852270000</b>		<b>ORLR40398G</b>	
NM-Germany Article no. Artikelnummer/ Modelo Número / статья НОМЕР	NM-Germany Article no.	NM-Germany Article no.	NM-Germany Article no.	NM-Germany Article no.	NM-Germany Article no.	NM-Germany Article no.	NM-Germany Article no.	NM-Germany Article no.	NM-Germany Article no.	NM-Germany Article no.	
	LBSLR40398GF	LBLR40398GF	KBSLR40398G	KBLR40398G	KBLR40398G	KRLR40398G					

ENGINE TYPE Motortyp Type de Moteur Tipo de motor Тип двигателя	LINER KIT Liner Kit Kit de Chemise Camisas de los cilindros лайнер комплект	CYL. LINER Zylinderlaufbuchse Chemise Camisas de los cilindros втулка цилиндра	PISTON + RINGS Kolben + Ringe Piston + Segments Pistón Set Поршень и кольца			PISTON SET Kolben Set Set de Piston Pistón Set поршневой	RINGS SET Kolben Set Segments de Piston Anillos Set кольца	PIN Pin Axe Perno Пин			
<b>XUD 9</b> <b>XUD 9A</b> 4 Cyl 83.0 mm Bore Ø 1,905 cc 	<b>(A)</b> <b>K-93648970</b> <b>M-0392490</b> consists of (C) <b>(B)</b> <b>M-0392491</b> consists of (D)	(C) (D) Length: 153.5 153.5 Outside Ø: 86.0 86.0 Flange Ø: 89.0 flange depth 4.8	Length: 84.3 Comp: 46.8 Height: -2.2			Top: 2.0 2nd: 2.0 3rd: 3.0 1st oil: 3.0 2nd oil:	Ø: 25.0 Length: 72.0				
		Reference no.:		Reference no.:		Reference no.:		Reference no.:		O-RING	
		<b>(C)</b> <b>K-89184190</b> <b>M-039WV21</b> <b>(D)</b> <b>M-039WV32</b>		<b>A-350709</b> <b>K-93648700</b> <b>M-0392400</b> <b>N-8715200010</b>				<b>A-R66390</b> <b>G-0815200000</b> <b>K-800003740000</b> <b>M-03924N0</b>			
NM-Germany Article no. Artikelnummer/ Modelo Número / статья НОМЕР	NM-Germany Article no.	NM-Germany Article no.	NM-Germany Article no.	NM-Germany Article no.	NM-Germany Article no.	NM-Germany Article no.	NM-Germany Article no.	NM-Germany Article no.	NM-Germany Article no.	NM-Germany Article no.	
	LBSLR40399DP (A) LBSLR40399DS (B)	LBLR40399DP (C) LBLR40399DS (D)	KBSLR40399D	KBLR40399D	KBLR40399D	KRLR40399D					

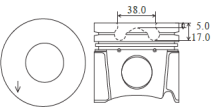
LAND ROVER

ENGINE TYPE Motortyp Type de Moteur Tipo de motor Тип двигателя	LINER KIT Liner Kit Kit de Chemise Camisas de los cilindros лайнер комплект	CYL. LINER Zylinderlaufbuchse Chemise Camisas de los cilindros втулка цилиндра	PISTON + RINGS Kolben + Ringe Piston + Segments Pistón Set Поршень и кольца			PISTON SET Kolben Set Set de Piston Pistón Set поршневой	RINGS SET Kolben Set Segments de Piston Anillos Set кольца	PIN Pin Axe Perno Пин			
<b>20T2N TURBO</b> <b>20T2R TURBO</b> 4 Cyl 84.45 mm Bore Ø 1,994 cc 	<b>(A)</b> <b>K-94401960</b> consists of (C) <b>(B)</b> consists of (D)	(C) (D) Length: 158.5 158.5 Outside Ø: 88.0 88.0 Flange Ø: 90.05 flange depth 4.0	Length: 76.97 Comp: 47.97 Height: -5.0 -17.0	alfin skirt MOS2 treated fits tapered con. rod		Top: 3.0 double keystone 2nd: 2.0 3rd: 3.0 1st oil: 3.0 2nd oil:	Ø: 30.0 Length: 70.0				
		Reference no.:		Reference no.:		Reference no.:		Reference no.:		O-RING	
		<b>(C)</b> <b>K-89536190</b> <b>(D)</b>		<b>LFL104750L</b> <b>A-A350500</b> <b>K-94401600</b> <b>M-2014500</b> <b>N-8711980000</b>		<b>ERR5631L</b> <b>ERR5643</b>		<b>LFP101240L</b> <b>LFP101750L</b> <b>A-R49390</b> <b>G-0811980000</b> <b>K-800023640000</b>			
NM-Germany Article no. Artikelnummer/ Modelo Número / статья НОМЕР	NM-Germany Article no.	NM-Germany Article no.	NM-Germany Article no.	NM-Germany Article no.	NM-Germany Article no.	NM-Germany Article no.	NM-Germany Article no.	NM-Germany Article no.	NM-Germany Article no.	NM-Germany Article no.	
	LBSLR40400DPA (A) LBSLR40400DSA (B)	LBLR40400DP (C) LBLR40400DS (D)	KBSLR40400D	KBLR40400D	KBLR40400D	KRLR40400D					

ENGINE TYPE	LINER KIT	CYL. LINER	PISTON + RINGS		PISTON SET	RINGS SET	PIN
Motortyp Type de Moteur Tipo de motor Тип двигателя	Liner Kit Kit de Chemise Camisas de los cilindros лайнер комплект	Zylinderlaufbuchse Chemise Camisas de los cilindros втулка цилиндра	Kolben + Ringe Piston + Segments Pistón Set Поршень и кольца		Kolben Set Set de Piston Pistón Set поршень	Kolben Set Segments de Piston Anillos Set кольца	Pin Axe Perno Пин
<b>5R</b> 5 Cyl 84.45 mm Bore Ø 2,496 cc	<b>(A)</b> K-99418960 consists of (C)  <b>(B)</b> consists of (D)	(C)	(D)	STD	O/S	Top: 3.0 half keystone	Ø: 30.0 Length: 70.0
		Length: 158.5	158.5	Length: 78.94	78.69	2nd: 2.0	
		Outside Ø: 88.0	88.0	Comp: 47.94	47.69	3rd: 3.0	1st oil: 3.0
		Flange Ø: 90.05	4.0	Height: -17.4	-17.4	2nd oil:	
		flange depth					
		Reference no.:	Reference no.:	Reference no.:	Reference no.:	O-RING	
		<b>(C)</b> K-89536190	<b>(D)</b> LFL000460 LFL105300 LFL500030 LFL500040 K-99418600 M-2014600	ERR7177	LFT100300 STC4668 STC4745 K-800049310000		
NM-Germany Article no. Artikelnummer/ Modelo Número / статья НОМЕР	NM-Germany Article no.	NM-Germany Article no.	NM-Germany Article no.	NM-Germany Article no.	NM-Germany Article no.	NM-Germany Article no.	NM-Germany Article no.
	LBSLR50401DPB (A) LBSLR50401DSB (B)	LBLR50401DP (C) LBLR50401DS (D)	KBSLR50401DB	KBLR50401DB	KRLR50401D		



## DIESEL

ENGINE TYPE	LINER KIT	CYL. LINER	PISTON + RINGS		PISTON SET	RINGS SET	PIN
Motortyp Type de Moteur Tipo de motor Тип двигателя	Liner Kit Kit de Chemise Camisas de los cilindros лайнер комплект	Zylinderlaufbuchse Chemise Camisas de los cilindros втулка цилиндра	Kolben + Ringe Piston + Segments Pistón Set Поршень и кольца		Kolben Set Set de Piston Pistón Set поршень	Kolben Set Segments de Piston Anillos Set кольца	Pin Axe Perno Пин
<b>4.20 A</b> <b>4.20 N</b> 4 Cyl 84.45 mm Bore Ø 1,993 cc						Top: 2.0 2nd: 1.75 3rd: 3.0 1st oil: 3.0 2nd oil:	Ø: 28.0 Length: 71.0
		Length: 77.0		Length: 77.0			
		Outside Ø: 48.0		Comp: 48.0		Height: -14.3	
		Flange Ø: 14.3					
		flange depth					
		Reference no.:	Reference no.:	Reference no.:	Reference no.:	O-RING	
			M-0435200		A-R43250 G-0832460000 M-04334N0		
NM-Germany Article no. Artikelnummer/ Modelo Número / статья НОМЕР	NM-Germany Article no.	NM-Germany Article no.	NM-Germany Article no.	NM-Germany Article no.	NM-Germany Article no.	NM-Germany Article no.	NM-Germany Article no.
			KBSLR40402DA	KBLR40402DA	KRLR40402DA		

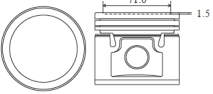

## DIESEL

ENGINE TYPE	LINER KIT	CYL. LINER	PISTON + RINGS		PISTON SET	RINGS SET	PIN
Motortyp Type de Moteur Tipo de motor Тип двигателя	Liner Kit Kit de Chemise Camisas de los cilindros лайнер комплект	Zylinderlaufbuchse Chemise Camisas de los cilindros втулка цилиндра	Kolben + Ringe Piston + Segments Pistón Set Поршень и кольца		Kolben Set Set de Piston Pistón Set поршень	Kolben Set Segments de Piston Anillos Set кольца	Pin Axe Perno Пин
<b>4.20 TURBO</b> 4 Cyl 84.45 mm Bore Ø 1,993 cc						Top: 2.0 2nd: 1.75 3rd: 3.0 1st oil: 3.0 2nd oil:	Ø: 28.0 Length: 71.0
		Length: 77.0		Length: 77.0			
		Outside Ø: 48.0		Comp: 48.0		Height: -14.0	
		Flange Ø: 14.0					
		flange depth					
		Reference no.:	Reference no.:	Reference no.:	Reference no.:	O-RING	
			M-0435300		A-R43250 G-0832460000 M-04334N0		
NM-Germany Article no. Artikelnummer/ Modelo Número / статья НОМЕР	NM-Germany Article no.	NM-Germany Article no.	NM-Germany Article no.	NM-Germany Article no.	NM-Germany Article no.	NM-Germany Article no.	NM-Germany Article no.
			KBSLR40403DA	KBLR40403DA	KRLR40403DA		

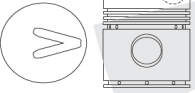

## GASOLINE

ENGINE TYPE Motortyp Type de Moteur Tipo de motor Тип двигателя	LINER KIT Liner Kit Kit de Chemise Camisas de los cilindros лайнер комплект	CYL. LINER Zylinderlaufbuchse Chemise Camisas de los cilindros втулка цилиндра	PISTON + RINGS Kolben + Ringe Piston + Segments Pistón Set Поршень и кольца	PISTON SET Kolben Set Set de Piston Pistón Set поршневой	RINGS SET Kolben Set Segments de Piston Anillos Set кольца	PIN Pin Axe Perno Пин
<b>RANGE ROVER 3.5</b>						
<b>8 Cyl</b> <b>88.86 mm Bore Ø</b> <b>3,528 cc</b>		Length: 77.09 Outside Ø: Flange Ø: flange depth	Length: 77.09 Comp: 47.37 Height: -1.5		Top: 1.59 2nd: 1.59 3rd: 4.76 1st oil: 2nd oil:	Ø: 22.22 Length: 72.6
						
NM-Germany Article no. Artikelnummer/ Modelo Número / статья НОМЕР	NM-Germany Article no.	NM-Germany Article no.	NM-Germany Article no.	NM-Germany Article no.	NM-Germany Article no.	NM-Germany Article no.
			<b>KBSLR80404G</b>	<b>KBLR80404G</b>	<b>KRLR80404G</b>	

## DIESEL

ENGINE TYPE Motortyp Type de Moteur Tipo de motor Тип двигателя	LINER KIT Liner Kit Kit de Chemise Camisas de los cilindros лайнер комплект	CYL. LINER Zylinderlaufbuchse Chemise Camisas de los cilindros втулка цилиндра	PISTON + RINGS Kolben + Ringe Piston + Segments Pistón Set Поршень и кольца	PISTON SET Kolben Set Set de Piston Pistón Set поршневой	RINGS SET Kolben Set Segments de Piston Anillos Set кольца	PIN Pin Axe Perno Пин
<b>2.3 D</b>						
<b>4 Cyl</b> <b>90.487 mm Bore Ø</b> <b>2,286 cc</b>	(A) <b>K-91188971</b> <b>M-2014280</b> consists of (C)  (B) <b>K-91188972</b> consists of (D)	(C) (D) Length: 191.3 191.2 Outside Ø: 93.7 94.5 Flange Ø: 99.5 flange depth 4.5	Length: 100.0 Comp: 58.4 Height: -6.5		Top: 2.39 2nd: 2.39 3rd: 2.39 1st oil: 4.75 2nd oil: 4.75	Ø: 30.15 Length: 74.5
						
NM-Germany Article no. Artikelnummer/ Modelo Número / статья НОМЕР	NM-Germany Article no.	NM-Germany Article no.	NM-Germany Article no.	NM-Germany Article no.	NM-Germany Article no.	NM-Germany Article no.
	<b>LBSLR40405DP (A)</b> <b>LBSLR40405DS (B)</b>	<b>LBLR40405DP (C)</b> <b>LBLR40405DS (D)</b>	<b>KBSLR40405DB</b>	<b>KBLR40405DB</b>	<b>KRLR40405D</b>	

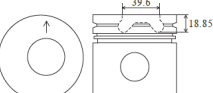
## DIESEL

ENGINE TYPE Motortyp Type de Moteur Tipo de motor Тип двигателя	LINER KIT Liner Kit Kit de Chemise Camisas de los cilindros лайнер комплект	CYL. LINER Zylinderlaufbuchse Chemise Camisas de los cilindros втулка цилиндра	PISTON + RINGS Kolben + Ringe Piston + Segments Pistón Set Поршень и кольца	PISTON SET Kolben Set Set de Piston Pistón Set поршневой	RINGS SET Kolben Set Segments de Piston Anillos Set кольца	PIN Pin Axe Perno Пин
<b>11L/12L</b> <b>14L/21L</b> <b>TDi 200</b>	(A) consists of (C)  (B) consists of (D)	(C) (D) Length: 191.36 191.36 Outside Ø: 94.5 94.5 Flange Ø: 99.7 flange depth 4.76	Length: 91.9 Comp: 55.4 Height: -18.85	alfin fits tapered con. rod	Top: 2.5 double keystone 2nd: 2.0 3rd: 3.0 1st oil: 2nd oil:	Ø: 30.16 Length: 77.0
<b>4 Cyl</b> <b>90.475 mm Bore Ø</b> <b>2,496 cc</b>						
						
NM-Germany Article no. Artikelnummer/ Modelo Número / статья НОМЕР	NM-Germany Article no.	NM-Germany Article no.	NM-Germany Article no.	NM-Germany Article no.	NM-Germany Article no.	NM-Germany Article no.
	<b>LBSLR40406DPA (A)</b> <b>LBSLR40406DSA (B)</b>	<b>LBLR40406DP (C)</b> <b>LBLR40406DS (D)</b>	<b>KBSLR40406DA</b>	<b>KBLR40406DA</b>	<b>KRLR40406D</b>	

**DIESEL**

ENGINE TYPE	LINER KIT	CYL. LINER	PISTON + RINGS		PISTON SET	RINGS SET	PIN	
Motor typ Type de Moteur Tipo de motor Тип двигателя	Liner Kit Kit de Chemise Camisas de los cilindros лайнер комплект	Zylinderlaufbuchse Chemise Camisas de los cilindros втулка цилиндра	Kolben + Ringe Piston + Segments Pistón Set Поршень и кольца		Kolben Set Set de Piston Pistón Set поршневой	Kolben Set Segments de Piston Anillos Set кольца	Pin Axe Perno Пин	
<b>14L/16L/17L 19L/23L TDi 300</b> 4 Cyl 90.475 mm Bore Ø 2,496 cc	<b>(A) consists of (C)</b>  <b>(B) consists of (D)</b>	Length:	(C) 191.36	(D) 191.36	Length:	91.9	alfin fits tapered con. rod  Top: 3.0 double keystone 2nd: 2.5 3rd: 3.0 1st oil: 2nd oil:	Ø: 30.16  Length: 77.0
		Outside Ø:	94.5	94.5	Comp:	55.4		
		Flange Ø:		99.7	Height:	-4.3		
		flange depth		4.76		-18.5		
		Reference no.:		Reference no.:	Reference no.:	Reference no.:	O-RING	
		<b>(C)</b> ERC9188 A-SU494402 G-1401092000 K-88692190 M-201WV03		<b>A-A350973</b> K-92253600 M-2014400 N-8752180020		<b>A-R48730</b> G-0852180020 K-800023840000 M-20144N0		
		<b>(D)</b> G-1402471000						
NM-Germany Article no. Artikelnummer/ Modelo Número / статья НОМЕР	NM-Germany Article no.	NM-Germany Article no.	NM-Germany Article no.	NM-Germany Article no.	NM-Germany Article no.	NM-Germany Article no.	NM-Germany Article no.	
	LBSLR40407DPA (A) LBSLR40407DSA (B)	LBLR40407DP (C) LBLR40407DS (D)	KBSLR40407DA	KBLR40407DA	KRLR40407D			



**GASOLINE**



ENGINE TYPE	LINER KIT	CYL. LINER	PISTON + RINGS		PISTON SET	RINGS SET	PIN	
Motor typ Type de Moteur Tipo de motor Тип двигателя	Liner Kit Kit de Chemise Camisas de los cilindros лайнер комплект	Zylinderlaufbuchse Chemise Camisas de los cilindros втулка цилиндра	Kolben + Ringe Piston + Segments Pistón Set Поршень и кольца		Kolben Set Set de Piston Pistón Set поршневой	Kolben Set Segments de Piston Anillos Set кольца	Pin Axe Perno Пин	
<b>2.3 Ltr.P</b> 4 Cyl 90.48 mm Bore Ø 2,286 cc	<b>(A) consists of (C)</b>  <b>(B) consists of (D)</b>	Length:	(C) 191.3	(D) 191.2	Length:	100.0	Top: 1.78 2nd: 1.78 3rd: 4.75 1st oil: 2nd oil:	Ø: 25.4  Length: 76.0
		Outside Ø:	93.7	94.5	Comp:	58.5		
		Flange Ø:		99.5	Height:	+0		
		flange depth		4.5				
		Reference no.:		Reference no.:	Reference no.:	Reference no.:	O-RING	
		<b>(C)</b> K-88391190 M-201WV02		<b>A-20128V3</b> K-91185600 M-2014100 N-8726310000		608255  <b>A-R11686V1</b> G-0826310000		
		<b>(D)</b> K-89425190						
NM-Germany Article no. Artikelnummer/ Modelo Número / статья НОМЕР	NM-Germany Article no.	NM-Germany Article no.	NM-Germany Article no.	NM-Germany Article no.	NM-Germany Article no.	NM-Germany Article no.	NM-Germany Article no.	
	LBSLR40408GP (A) LBSLR40408GS (B)	LBLR40408GP (C) LBLR40408GS (D)	KBSLR40408GA	KBLR40408GA	KRLR40408G			

**DIESEL**

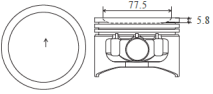
ENGINE TYPE	LINER KIT	CYL. LINER	PISTON + RINGS		PISTON SET	RINGS SET	PIN	
Motor typ Type de Moteur Tipo de motor Тип двигателя	Liner Kit Kit de Chemise Camisas de los cilindros лайнер комплект	Zylinderlaufbuchse Chemise Camisas de los cilindros втулка цилиндра	Kolben + Ringe Piston + Segments Pistón Set Поршень и кольца		Kolben Set Set de Piston Pistón Set поршневой	Kolben Set Segments de Piston Anillos Set кольца	Pin Axe Perno Пин	
<b>HR TURBO VM TURBO</b> 4 Cyl 92.0 mm Bore Ø 2,499 cc	<b>A-ASA2460</b> K-92286961 K-92286971 M-4891390 N-8911010000	Length:	168.0		Length:	86.1	alfin head and top ring land anodized  Top: 2.5 double key- stone 2nd: 2.0 3rd: 4.0 1st oil: 2nd oil:	Ø: 30.0  Length: 75.5
		Outside Ø:	103.0		Comp:	51.1		
		Flange Ø:	110.0		Height:	-2.3		
		flange depth	8.9 +1.2			-3.9		
		Reference no.:		Reference no.:	Reference no.:	Reference no.:	O-RING	
		<b>A-SJ351453</b> G-1467642000 K-89500110 M-489WN01		<b>K-92286600</b> K-92286700 M-4891300		<b>A-R47730</b> G-0811010000 K-800000110000 M-48912N0		ORLR40409DA
NM-Germany Article no. Artikelnummer/ Modelo Número / статья НОМЕР	NM-Germany Article no.	NM-Germany Article no.	NM-Germany Article no.	NM-Germany Article no.	NM-Germany Article no.	NM-Germany Article no.	NM-Germany Article no.	
	LBSLR40409DFA	LBLR40409DFA	KBSLR40409DA	KBLR40409DA	KRLR40409DA			

**GASOLINE**

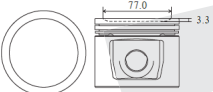
ENGINE TYPE Motortyp Type de Moteur Tipo de motor Тип двигателя	LINER KIT Liner Kit Kit de Chemise Camisas de los cilindros лайнер комплект	CYL. LINER Zylinderlaufbuchse Chemise Camisas de los cilindros втулка цилиндра	PISTON + RINGS Kolben + Ringe Piston + Segments Pistón Set Поршень и кольца	PISTON SET Kolben Set Set de Piston Pistón Set поршневой	RINGS SET Kolben Set Segments de Piston Anillos Set кольца	PIN Pin Axe Perno Пин
<b>46D</b> 8 Cyl 94.0 mm Bore Ø 4,554 cc 		Length: 136.75 Outside Ø: 97.77 Flange Ø: flange depth	Length: 66.4 Comp: 35.9 Height: -5.8		Top: 1.2 2nd: 1.5 3rd: 1st oil: 3.0 2nd oil:	Ø: 24.0 Length: 60.2
		<b>Reference no.:</b>	<b>Reference no.:</b>	<b>Reference no.:</b>	<b>Reference no.:</b>	<b>O-RING</b>
		<b>A-SU4310 G-1401086000</b>	<b>A-24078 N-8752150010</b>	<b>DW4620</b>	<b>A-R49500 G-0852150000</b>	
NM-Germany Article no. Artikelnummer/ Modelo Número / статья НОМЕР	NM-Germany Article no.	NM-Germany Article no.	NM-Germany Article no.	NM-Germany Article no.	NM-Germany Article no.	NM-Germany Article no.
	<b>LBSLR80410GP</b>	<b>LBLR80410GP</b>	<b>KBSLR80410G</b>	<b>KBLR80410G</b>	<b>KRLR80410G</b>	

ENGINE TYPE Motortyp Type de Moteur Tipo de motor Тип двигателя	LINER KIT Liner Kit Kit de Chemise Camisas de los cilindros лайнер комплект	CYL. LINER Zylinderlaufbuchse Chemise Camisas de los cilindros втулка цилиндра	PISTON + RINGS Kolben + Ringe Piston + Segments Pistón Set Поршень и кольца	PISTON SET Kolben Set Set de Piston Pistón Set поршневой	RINGS SET Kolben Set Segments de Piston Anillos Set кольца	PIN Pin Axe Perno Пин
<b>42D</b> 8 Cyl 94.0 mm Bore Ø 3,947 cc 		Length: Outside Ø: Flange Ø: flange depth	Length: 77.0 Comp: 47.2 Height: -3.3		Top: 1.5 2nd: 1.5 3rd: 1st oil: 3.0 2nd oil:	Ø: 22.22 Length: 72.6
		<b>Reference no.:</b>	<b>Reference no.:</b>	<b>Reference no.:</b>	<b>Reference no.:</b>	<b>O-RING</b>
			<b>A-23874 N-8752450000</b>	<b>DW895</b>	<b>A-R45050 G-0852450000</b>	
NM-Germany Article no. Artikelnummer/ Modelo Número / статья НОМЕР	NM-Germany Article no.	NM-Germany Article no.	NM-Germany Article no.	NM-Germany Article no.	NM-Germany Article no.	NM-Germany Article no.
			<b>KBSLR80411G</b>	<b>KBLR80411G</b>	<b>KRLR80411G</b>	

LAND ROVER

# MERCEDES BENZ

Kolben • Piston & Rings • Pistón & Anillos • Поршень и Кольца

## GASOLINE

ENGINE TYPE	LINER KIT	CYL. LINER	PISTON + RINGS		PISTON SET	RINGS SET	PIN
Motortyp Type de Moteur Tipo de motor Тип двигателя	Liner Kit Kit de Chemise Camisas de los cilindros лайнер комплект	Zylinderlaufbuchse Chemise Camisas de los cilindros втулка цилиндра	Kolben + Ringe Piston + Segments Pistón Set Поршень и кольца		Kolben Set Set de Piston Pistón Set поршневой	Kolben Set Segments de Piston Anillos Set кольца	Pin Axe Perno Пин
<b>M 160 R3(SMART)</b> 3 Cyl 63.5 mm Bore Ø 599 cc		Length: Outside Ø: Flange Ø: flange depth	STD	O/S		Top: 1.2	Ø: 16.0 Length: 48.0
			Length: 43.5	43.2		2nd: 1.5	
			Comp: 27.0	26.7		3rd: 2.5	
			Height: -2.8	-2.8		1st oil: 2.5	
			Reference no.:	Reference no.:	Reference no.:	Reference no.:	O-RING
				<b>K-99455600</b> <b>M-0039400</b> <b>N-8713670000</b>	<b>160 030 03 17</b>	<b>A-R66860</b> <b>G-0813670000</b> <b>K-800037210000</b> <b>M-00394N0</b>	
NM-Germany Article no. Artikelnummer/ Modelo Número / статья НОМЕР	NM-Germany Article no.	NM-Germany Article no.	NM-Germany Article no.	NM-Germany Article no.	NM-Germany Article no.	NM-Germany Article no.	NM-Germany Article no.
			<b>KBSMB30417G</b>	<b>KBMB30417G</b>	<b>KRMB30417G</b>		

## DIESEL

ENGINE TYPE	LINER KIT	CYL. LINER	PISTON + RINGS		PISTON SET	RINGS SET	PIN
Motortyp Type de Moteur Tipo de motor Тип двигателя	Liner Kit Kit de Chemise Camisas de los cilindros лайнер комплект	Zylinderlaufbuchse Chemise Camisas de los cilindros втулка цилиндра	Kolben + Ringe Piston + Segments Pistón Set Поршень и кольца		Kolben Set Set de Piston Pistón Set поршневой	Kolben Set Segments de Piston Anillos Set кольца	Pin Axe Perno Пин
<b>OM 660 (SMART)</b> 3 Cyl 65.5 mm Bore Ø 799 cc		Length: Outside Ø: Flange Ø: flange depth	STD	O/S	alfin skirt MOS2 treated	Top: 1.5	Ø: 23.0 Length: 53.0
			Length: 60.0	60.0		2nd: 1.5	
			Comp: 36.0	35.75		3rd: 2.5	
			Height: -2.9	-2.9		1st oil: 2.5	
			-11.1	-11.1		2nd oil:	
			Reference no.:	Reference no.:	Reference no.:	Reference no.:	O-RING
				<b>K-94597600</b> <b>M-0039500</b>	<b>660 030 01 17</b>	<b>660 037 01 16</b> <b>660 037 02 18</b> <b>660 037 03 16</b> <b>G-0814060000</b> <b>K-800070110000</b> <b>M-00395N0</b>	
NM-Germany Article no. Artikelnummer/ Modelo Número / статья НОМЕР	NM-Germany Article no.	NM-Germany Article no.	NM-Germany Article no.	NM-Germany Article no.	NM-Germany Article no.	NM-Germany Article no.	NM-Germany Article no.
			<b>KBSMB30418DA</b>	<b>KBMB30418DA</b>	<b>KRMB30418DA</b>		

## DIESEL

ENGINE TYPE	LINER KIT	CYL. LINER	PISTON + RINGS		PISTON SET	RINGS SET	PIN
Motortyp Type de Moteur Tipo de motor Тип двигателя	Liner Kit Kit de Chemise Camisas de los cilindros лайнер комплект	Zylinderlaufbuchse Chemise Camisas de los cilindros втулка цилиндра	Kolben + Ringe Piston + Segments Pistón Set Поршень и кольца		Kolben Set Set de Piston Pistón Set поршневой	Kolben Set Segments de Piston Anillos Set кольца	Pin Axe Perno Пин
<b>OM 660 (SMART)</b> 3 Cyl 65.5 mm Bore Ø 799 cc		Length: Outside Ø: Flange Ø: flange depth	STD	O/S	alfin skirt MOS2 treated	Top: 1.5	Ø: 23.0 Length: 53.0
			Length: 60.0			2nd: 1.5	
			Comp: 36.0			3rd: 2.5	
			Height: -5.5			1st oil: 2.5	
			-12.6			2nd oil:	
			Reference no.:	Reference no.:	Reference no.:	Reference no.:	O-RING
				<b>K-40486600</b>	<b>660 030 03 17</b>	<b>660 037 01 16</b> <b>660 037 02 18</b> <b>660 037 03 16</b> <b>G-0814060000</b> <b>K-800070110000</b> <b>M-00395N0</b>	
NM-Germany Article no. Artikelnummer/ Modelo Número / статья НОМЕР	NM-Germany Article no.	NM-Germany Article no.	NM-Germany Article no.	NM-Germany Article no.	NM-Germany Article no.	NM-Germany Article no.	NM-Germany Article no.
			<b>KBSMB30419DA</b>	<b>KBMB30419DA</b>	<b>KRMB30419DA</b>		

**GASOLINE**

ENGINE TYPE Motortyp Type de Moteur Tipo de motor Тип двигателя	LINER KIT Liner Kit Kit de Chemise Camisas de los cilindros лайнер комплект	CYL. LINER Zylinderlaufbuchse Chemise Camisas de los cilindros втулка цилиндра	PISTON + RINGS Kolben + Ringe Piston + Segments Pistón Set Поршень и кольца			PISTON SET Kolben Set Set de Piston Pistón Set поршневой	RINGS SET Kolben Set Segments de Piston Anillos Set кольца	PIN Pin Axe Perno Пин
<b>0.7L (SMART)</b> 3 Cyl 66.5 mm Bore Ø 698 cc		Length: Outside Ø: Flange Ø: flange depth	Length: 41.7 Comp: 25.2 Height: -3.3			Top: 1.2	Ø: 16.0 Length: 52.0	
						2nd: 1.2		
						3rd: 2.5 1st oil: 2nd oil:		
		Reference no.:	Reference no.:	Reference no.:	Reference no.:	O-RING		
			<b>K-99927600</b>		<b>K-800050310000</b>			
NM-Germany Article no. Artikelnummer/ Modelo Número / статья НОМЕР	NM-Germany Article no.	NM-Germany Article no.	NM-Germany Article no.	NM-Germany Article no.	NM-Germany Article no.	NM-Germany Article no.	NM-Germany Article no.	
			<b>KBSMB30420G</b>	<b>KBMB30420G</b>	<b>KRMB30420G</b>			

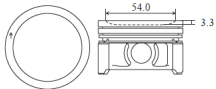

**GASOLINE**

ENGINE TYPE Motortyp Type de Moteur Tipo de motor Тип двигателя	LINER KIT Liner Kit Kit de Chemise Camisas de los cilindros лайнер комплект	CYL. LINER Zylinderlaufbuchse Chemise Camisas de los cilindros втулка цилиндра	PISTON + RINGS Kolben + Ringe Piston + Segments Pistón Set Поршень и кольца			PISTON SET Kolben Set Set de Piston Pistón Set поршневой	RINGS SET Kolben Set Segments de Piston Anillos Set кольца	PIN Pin Axe Perno Пин
<b>0.7L (SMART)</b> 3 Cyl 66.5 mm Bore Ø 698 cc		Length: Outside Ø: Flange Ø: flange depth	Length: 41.8 Comp: 25.2 Height: -4.0			top and 2nd ring lands anodized skirt MOS2 treated	Top: 1.2	Ø: 17.0 Length: 52.0
						2nd: 1.5		
						3rd: 2.5 1st oil: 2nd oil:		
		Reference no.:	Reference no.:	Reference no.:	Reference no.:	O-RING		
			<b>KBSMB30421G</b>	<b>KBMB30421G</b>	<b>KRMB30421G</b>			
NM-Germany Article no. Artikelnummer/ Modelo Número / статья НОМЕР	NM-Germany Article no.	NM-Germany Article no.	NM-Germany Article no.	NM-Germany Article no.	NM-Germany Article no.	NM-Germany Article no.	NM-Germany Article no.	
			<b>KBSMB30421G</b>	<b>KBMB30421G</b>	<b>KRMB30421G</b>			

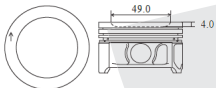

**GASOLINE**

ENGINE TYPE Motortyp Type de Moteur Tipo de motor Тип двигателя	LINER KIT Liner Kit Kit de Chemise Camisas de los cilindros лайнер комплект	CYL. LINER Zylinderlaufbuchse Chemise Camisas de los cilindros втулка цилиндра	PISTON + RINGS Kolben + Ringe Piston + Segments Pistón Set Поршень и кольца			PISTON SET Kolben Set Set de Piston Pistón Set поршневой	RINGS SET Kolben Set Segments de Piston Anillos Set кольца	PIN Pin Axe Perno Пин
<b>0.7L (SMART)</b> 3 Cyl 66.5 mm Bore Ø 698 cc		Length: Outside Ø: Flange Ø: flange depth	Length: 41.7 Comp: 25.2 Height: -3.3			Top: 1.2	Ø: 16.0 Length: 52.0	
						2nd: 1.5		
						3rd: 2.5 1st oil: 2nd oil:		
		Reference no.:	Reference no.:	Reference no.:	Reference no.:	O-RING		
			<b>KBSMB30422G</b>	<b>KBMB30422G</b>	<b>KRMB30422G</b>			
NM-Germany Article no. Artikelnummer/ Modelo Número / статья НОМЕР	NM-Germany Article no.	NM-Germany Article no.	NM-Germany Article no.	NM-Germany Article no.	NM-Germany Article no.	NM-Germany Article no.	NM-Germany Article no.	
			<b>KBSMB30422G</b>	<b>KBMB30422G</b>	<b>KRMB30422G</b>			

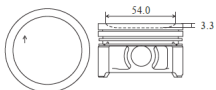

# MERCEDES BENZ

Kolben • Piston & Rings • Pistón & Anillos • Поршень и Кольца

## DIESEL

ENGINE TYPE Motortyp Type de Moteur Tipo de motor Тип двигателя	LINER KIT Liner Kit Kit de Chemise Camisas de los cilindros лайнер комплект	CYL. LINER Zylinderlaufbuchse Chemise Camisas de los cilindros втулка цилиндра	PISTON + RINGS Kolben + Ringe Piston + Segments Pistón Set Поршень и кольца			PISTON SET Kolben Set Set de Piston Pistón Set поршневой	RINGS SET Kolben Set Segments de Piston Anillos Set кольца	PIN Pin Axe Perno Пин
<b>OM 668 TURBO</b> 4 Cyl 80.0 mm Bore Ø 1,689 cc		Length: Outside Ø: Flange Ø: flange depth	Length: Comp: Height:	70.65 44.65 -11.65	alfin and with oil gallery skirt MOS2 treated	Top: 2.0	Ø: 28.0 Length: 60.0	
						2nd: 2.0		
						3rd: 3.0 1st oil: 2nd oil:		
		Reference no.:	Reference no.:	Reference no.:	Reference no.:	O-RING		
			<b>M-0031500</b>	<b>668 030 01 17</b> <b>668 030 04 17</b> <b>668 037 03 01</b>	<b>G-0810540000</b> <b>M-00315N0</b>			
NM-Germany Article no. Artikelnummer/ Modelo Número / статья НОМЕР	NM-Germany Article no.	NM-Germany Article no.	NM-Germany Article no.	NM-Germany Article no.	NM-Germany Article no.	NM-Germany Article no.		
			<b>KBSMB40423DB</b>	<b>KBMB40423DB</b>	<b>KRMB40423DB</b>			

## GASOLINE



ENGINE TYPE Motortyp Type de Moteur Tipo de motor Тип двигателя	LINER KIT Liner Kit Kit de Chemise Camisas de los cilindros лайнер комплект	CYL. LINER Zylinderlaufbuchse Chemise Camisas de los cilindros втулка цилиндра	PISTON + RINGS Kolben + Ringe Piston + Segments Pistón Set Поршень и кольца			PISTON SET Kolben Set Set de Piston Pistón Set поршневой	RINGS SET Kolben Set Segments de Piston Anillos Set кольца	PIN Pin Axe Perno Пин
<b>M166.960</b> <b>M166.961</b> 4 Cyl 80.0 mm Bore Ø 1,598 cc		Length: Outside Ø: Flange Ø: flange depth	Length: Comp: Height:	57.2 30.2 -2.3		Top: 1.2	Ø: 19.0 Length: 47.0	
						2nd: 1.75		
						3rd: 3.0 1st oil: 2nd oil:		
		Reference no.:	Reference no.:	Reference no.:	Reference no.:	O-RING		
			<b>K-94760600</b> <b>M-0012600</b>	<b>166 030 32 17</b>	<b>G-0810120000</b> <b>M-00124N0</b>			
NM-Germany Article no. Artikelnummer/ Modelo Número / статья НОМЕР	NM-Germany Article no.	NM-Germany Article no.	NM-Germany Article no.	NM-Germany Article no.	NM-Germany Article no.	NM-Germany Article no.		
			<b>KBSMB40424G</b>	<b>KBMB40424G</b>	<b>KRMB40424G</b>			

## GASOLINE



ENGINE TYPE Motortyp Type de Moteur Tipo de motor Тип двигателя	LINER KIT Liner Kit Kit de Chemise Camisas de los cilindros лайнер комплект	CYL. LINER Zylinderlaufbuchse Chemise Camisas de los cilindros втулка цилиндра	PISTON + RINGS Kolben + Ringe Piston + Segments Pistón Set Поршень и кольца			PISTON SET Kolben Set Set de Piston Pistón Set поршневой	RINGS SET Kolben Set Segments de Piston Anillos Set кольца	PIN Pin Axe Perno Пин
<b>M271</b> 4 Cyl 82.0 mm Bore Ø 1,796 cc		Length: Outside Ø: Flange Ø: flange depth	Length: Comp: Height:	50.9 29.9 -1.5	lands anodized skirt MOS2 treated	Top: 1.2	Ø: 20.0 Length: 56.0	
						2nd: 1.5		
						3rd: 2.5 1st oil: 2nd oil:		
		Reference no.:	Reference no.:	Reference no.:	Reference no.:	O-RING		
			<b>M-0040700</b>	<b>271 030 21 17</b> <b>271 037 18 01</b>	<b>271 030 00 24</b> <b>271 037 00 16</b> <b>271 037 00 17</b> <b>271 037 00 18</b> <b>271 037 02 16</b> <b>271 037 02 17</b> <b>271 037 02 18</b>			
NM-Germany Article no. Artikelnummer/ Modelo Número / статья НОМЕР	NM-Germany Article no.	NM-Germany Article no.	NM-Germany Article no.	NM-Germany Article no.	NM-Germany Article no.	NM-Germany Article no.		
			<b>KBSMB40425G</b>	<b>KBMB40425G</b>	<b>KRMB40425G</b>			

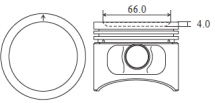

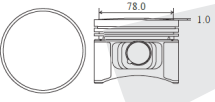

## GASOLINE

ENGINE TYPE	LINER KIT	CYL. LINER	PISTON + RINGS			PISTON SET	RINGS SET	PIN
Motor typ Type de Moteur Tipo de motor Тип двигателя	Liner Kit Kit de Chemise Camisas de los cilindros лайнер комплект	Zylinderlaufbuchse Chemise Camisas de los cilindros втулка цилиндра	Kolben + Ringe Piston + Segments Pistón Set Поршень и кольца			Kolben Set Set de Piston Pistón Set поршневой	Kolben Set Segments de Piston Anillos Set кольца	Pin Axe Perno Пин
<b>M103</b> 6 Cyl 82.9 mm Bore Ø 2,599 cc		Length: 132.3 Outside Ø: 85.9 Flange Ø: 88.7 flange depth 4.7	Length: 66.0 Comp: 33.0 Height: -4.0			Top: 1.5 2nd: 1.75 3rd: 3.0 1st oil: 2nd oil:	Ø: 22.0 Length: 52.0	
								
		Reference no.:	Reference no.:	Reference no.:	Reference no.:	O-RING		
		<b>K-89507190</b>	<b>K-93826600</b> <b>M-0020400</b>	<b>103 030 05 18</b> <b>103 030 61 17</b> <b>103 030 69 17</b> <b>103 030 92 18</b>	<b>G-0818310000</b> <b>K-800016860000</b> <b>M-00204N0</b>			
NM-Germany Article no. Artikelnummer/ Modelo Número / статья НОМЕР	NM-Germany Article no.	NM-Germany Article no.	NM-Germany Article no.	NM-Germany Article no.	NM-Germany Article no.	NM-Germany Article no.	NM-Germany Article no.	
	<b>LBSMB60426GS</b>	<b>LBMB60426GS</b>	<b>KBSMB60426G</b>	<b>KBMB60426G</b>	<b>KRMB60426G</b>			

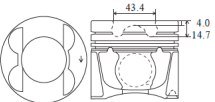

## GASOLINE

ENGINE TYPE	LINER KIT	CYL. LINER	PISTON + RINGS			PISTON SET	RINGS SET	PIN
Motor typ Type de Moteur Tipo de motor Тип двигателя	Liner Kit Kit de Chemise Camisas de los cilindros лайнер комплект	Zylinderlaufbuchse Chemise Camisas de los cilindros втулка цилиндра	Kolben + Ringe Piston + Segments Pistón Set Поршень и кольца			Kolben Set Set de Piston Pistón Set поршневой	Kolben Set Segments de Piston Anillos Set кольца	Pin Axe Perno Пин
<b>M103</b> 6 Cyl 82.9 mm Bore Ø 2,599 cc		Length: 132.3 Outside Ø: 85.9 Flange Ø: 88.7 flange depth 4.7	Length: 64.0 Comp: 33.0 Height: 0.9	0.50 0.50 1.00	skirt MOS2 treated	Top: 1.5 2nd: 1.75 3rd: 3.0 1st oil: 2nd oil:	Ø: 22.0 Length: 52.0	
								
		Reference no.:	Reference no.:	Reference no.:	Reference no.:	O-RING		
		<b>K-89507190</b>	<b>K-94392600</b> <b>M-0023200</b>	<b>103 030 17 18</b> <b>103 030 28 19</b> <b>103 030 96 18</b> <b>103 037 17 02</b> <b>103 037 69 02</b>	<b>G-0818310000</b> <b>K-800016860000</b> <b>M-00204N0</b>			
NM-Germany Article no. Artikelnummer/ Modelo Número / статья НОМЕР	NM-Germany Article no.	NM-Germany Article no.	NM-Germany Article no.	NM-Germany Article no.	NM-Germany Article no.	NM-Germany Article no.	NM-Germany Article no.	
	<b>LBSMB60427GS</b>	<b>LBMB60427GS</b>	<b>KBSMB60427G</b>	<b>KBMB60427G</b>	<b>KRMB60427G</b>			

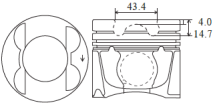

## DIESEL

ENGINE TYPE	LINER KIT	CYL. LINER	PISTON + RINGS			PISTON SET	RINGS SET	PIN
Motor typ Type de Moteur Tipo de motor Тип двигателя	Liner Kit Kit de Chemise Camisas de los cilindros лайнер комплект	Zylinderlaufbuchse Chemise Camisas de los cilindros втулка цилиндра	Kolben + Ringe Piston + Segments Pistón Set Поршень и кольца			Kolben Set Set de Piston Pistón Set поршневой	Kolben Set Segments de Piston Anillos Set кольца	Pin Axe Perno Пин
<b>OM 642</b> 6 Cyl 83.0 mm Bore Ø 2,987 cc		Length: 132.3 Outside Ø: 85.9 Flange Ø: 88.7 flange depth 4.7	Length: 71.7 Comp: 45.7 Height: -4.0		alfin and with oil gallery skirt MOS2 treated	Top: 2.0 double key-stone 2nd: 2.0 3rd: 2.0 1st oil: 2.0 2nd oil:	Ø: 30.0 Length: 66.0	
								
		Reference no.:	Reference no.:	Reference no.:	Reference no.:	O-RING		
			<b>K-40095600</b>	<b>642 030 06 17</b> <b>642 030 26 17</b> <b>642 030 45 17</b>	<b>K-800055820000</b> <b>M-00523N0</b>			
NM-Germany Article no. Artikelnummer/ Modelo Número / статья НОМЕР	NM-Germany Article no.	NM-Germany Article no.	NM-Germany Article no.	NM-Germany Article no.	NM-Germany Article no.	NM-Germany Article no.	NM-Germany Article no.	
			<b>KBSMB60428DB</b>	<b>KBMB60428DB</b> (for cyl 1/2/3)	<b>KBMB60428DB</b>			



**DIESEL**

ENGINE TYPE Motortyp Type de Moteur Tipo de motor Тип двигателя	LINER KIT Liner Kit Kit de Chemise Camisas de los cilindros лайнер комплект	CYL. LINER Zylinderlaufbuchse Chemise Camisas de los cilindros втулка цилиндра	PISTON + RINGS Kolben + Ringe Piston + Segments Pistón Set Поршень и кольца			PISTON SET Kolben Set Set de Piston Pistón Set поршневой	RINGS SET Kolben Set Segments de Piston Anillos Set кольца	PIN Pin Axe Perno Пин
<b>OM 642</b> <b>6 Cyl</b> <b>83.0 mm Bore Ø</b> <b>2,987 cc</b>		Length: Outside Ø: Flange Ø: flange depth	Length: Comp: Height:	71.7 45.7 -4.0 -14.7	alfin and with oil gallery skirt MOS2 treated	Top: 2.0 double key- stone 2nd: 2.0 3rd: 2.0 1st oil: 2.0 2nd oil:	Ø: 30.0 Length: 66.0	
			Reference no.:	Reference no.:	Reference no.:	Reference no.:	O-RING	
				<b>K-40096600</b>	<b>642 030 07 17</b> <b>642 030 27 17</b> <b>642 030 46 17</b>	<b>K-800055820000</b> <b>M-00523N0</b>		
NM-Germany Article no. Artikelnummer/ Modelo Número / статья НОМЕР	NM-Germany Article no.	NM-Germany Article no.	NM-Germany Article no.	NM-Germany Article no.	NM-Germany Article no.	NM-Germany Article no.	NM-Germany Article no.	
			<b>KBSMB60429DB</b>	(for cyl 4/5/6)		<b>KBMB60429DB</b>		

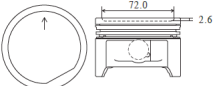

**DIESEL**

ENGINE TYPE Motortyp Type de Moteur Tipo de motor Тип двигателя	LINER KIT Liner Kit Kit de Chemise Camisas de los cilindros лайнер комплект	CYL. LINER Zylinderlaufbuchse Chemise Camisas de los cilindros втулка цилиндра	PISTON + RINGS Kolben + Ringe Piston + Segments Pistón Set Поршень и кольца			PISTON SET Kolben Set Set de Piston Pistón Set поршневой	RINGS SET Kolben Set Segments de Piston Anillos Set кольца	PIN Pin Axe Perno Пин
<b>OM 639 (SMART)</b> <b>OM 640</b> <b>3/4 Cyl</b> <b>83.0 mm Bore Ø</b> <b>1,493 cc 1,991 cc</b>		Length: Outside Ø: Flange Ø: flange depth	Length: Comp: Height:	71.65 45.65 -14.65	alfin and with oil gallery skirt MOS2 treated	Top: 2.0 2nd: 2.0 3rd: 2.0 1st oil: 2.0 2nd oil:	Ø: 30.0 Length: 66.0	
			Reference no.:	Reference no.:	Reference no.:	Reference no.:	O-RING	
				<b>K-99941600</b>	<b>640 030 04 17</b> <b>640 030 05 17</b>	<b>K-80054710000</b>		
NM-Germany Article no. Artikelnummer/ Modelo Número / статья НОМЕР	NM-Germany Article no.	NM-Germany Article no.	NM-Germany Article no.	NM-Germany Article no.	NM-Germany Article no.	NM-Germany Article no.	NM-Germany Article no.	
			<b>KBSMB340430DB</b>		<b>KBMB340430DB</b>	<b>KRMB340430DB</b>		

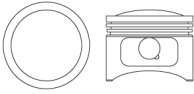

**GASOLINE**

ENGINE TYPE Motortyp Type de Moteur Tipo de motor Тип двигателя	LINER KIT Liner Kit Kit de Chemise Camisas de los cilindros лайнер комплект	CYL. LINER Zylinderlaufbuchse Chemise Camisas de los cilindros втулка цилиндра	PISTON + RINGS Kolben + Ringe Piston + Segments Pistón Set Поршень и кольца			PISTON SET Kolben Set Set de Piston Pistón Set поршневой	RINGS SET Kolben Set Segments de Piston Anillos Set кольца	PIN Pin Axe Perno Пин
<b>M166.990</b> <b>M166.991</b> <b>4 Cyl</b> <b>84.0 mm Bore Ø</b> <b>1,898 cc</b>		Length: Outside Ø: Flange Ø: flange depth	Length: Comp: Height:	58.1 31.1 -2.6		Top: 1.2 2nd: 1.75 3rd: 2.5 1st oil: 2nd oil:	Ø: 20.0 Length: 50.0	
			Reference no.:	Reference no.:	Reference no.:	Reference no.:	O-RING	
				<b>M-0032200</b>	<b>166 030 35 17</b>	<b>M-00322N0</b>		
NM-Germany Article no. Artikelnummer/ Modelo Número / статья НОМЕР	NM-Germany Article no.	NM-Germany Article no.	NM-Germany Article no.	NM-Germany Article no.	NM-Germany Article no.	NM-Germany Article no.	NM-Germany Article no.	
			<b>KBSMB40431G</b>		<b>KBMB40431G</b>	<b>KRMB40431G</b>		

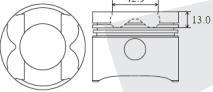

## GASOLINE

ENGINE TYPE	LINER KIT	CYL. LINER	PISTON + RINGS			PISTON SET	RINGS SET	PIN
Motor typ Type de Moteur Tipo de motor Тип двигателя	Liner Kit Kit de Chemise Camisas de los cilindros лайнер комплект	Zylinderlaufbuchse Chemise Camisas de los cilindros втулка цилиндра	Kolben + Ringe Piston + Segments Pistón Set Поршень и кольца			Kolben Set Set de Piston Pistón Set поршневой	Kolben Set Segments de Piston Anillos Set кольца	Pin Axe Perno Пин
<b>M111</b> 4 Cyl 85.3 mm Bore Ø 1,799 cc		Length: 129.0 Outside Ø: 88.3 Flange Ø: 91.3 flange depth 4.7	Length: 61.1 Comp: 30.1 Height: +6.0	STD 0.25 59.33 29.8 +4.53	0.50 59.12 29.8 +4.32		Top: 1.5 2nd: 1.75 3rd: 3.0 1st oil: 2nd oil:	Ø: 22.0 Length: 52.0
			Reference no.:	Reference no.:	Reference no.:	Reference no.:	O-RING	
			<b>K-89510190</b>	<b>K-94520600</b> <b>M-00292000</b> <b>M-0030100</b>	<b>111 030 08 18</b> <b>111 030 38 17</b> <b>111 030 84 17</b>	<b>M-00292N0</b> <b>M-00301N0</b>		
NM-Germany Article no. Artikelnummer/ Modelo Número / статья НОМЕР	NM-Germany Article no.	NM-Germany Article no.	NM-Germany Article no.	NM-Germany Article no.	NM-Germany Article no.	NM-Germany Article no.	NM-Germany Article no.	
	<b>LBSMB40432GS</b>	<b>LBMB40432GS</b>	<b>KBSMB40432G</b>	<b>KBMB40432G</b>	<b>KBMB40432G</b>	<b>KRMB40432G</b>		

## DIESEL

ENGINE TYPE	LINER KIT	CYL. LINER	PISTON + RINGS			PISTON SET	RINGS SET	PIN
Motor typ Type de Moteur Tipo de motor Тип двигателя	Liner Kit Kit de Chemise Camisas de los cilindros лайнер комплект	Zylinderlaufbuchse Chemise Camisas de los cilindros втулка цилиндра	Kolben + Ringe Piston + Segments Pistón Set Поршень и кольца			Kolben Set Set de Piston Pistón Set поршневой	Kolben Set Segments de Piston Anillos Set кольца	Pin Axe Perno Пин
<b>OM 628</b> 8 Cyl 86.0 mm Bore Ø 3,996 cc	<b>M-0040190</b> <b>M-0040100</b> <b>G-0813630000</b> <b>M-00401N0</b> <b>M-001WN20</b>	Length: 151.0 Outside Ø: 92.0 Flange Ø: 96.0 collar depth 58.02	Length: 68.25 Comp: 42.25 Height: -13.0			alfin and with oil gallery skirt MOS2 treated	Top: 2.5 2nd: 2.0 3rd: 3.0 1st oil: 2nd oil:	Ø: 30.0 Length: 68.0
			Reference no.:	Reference no.:	Reference no.:	Reference no.:	O-RING	
							<b>ORMB80433DB</b>	
NM-Germany Article no. Artikelnummer/ Modelo Número / статья НОМЕР	NM-Germany Article no.	NM-Germany Article no.	NM-Germany Article no.	NM-Germany Article no.	NM-Germany Article no.	NM-Germany Article no.	NM-Germany Article no.	
	<b>LBSMB80433DFB</b> (for cyl 1/2/3/4)	<b>LBMB80433DFB</b>	<b>KBSMB80433DB</b> (for cyl 1/2/3/4)	<b>KBMB80433DB</b> (for cyl 1/2/3/4)	<b>KBMB80433DB</b> (for cyl 1/2/3/4)	<b>KRMB80433DB</b>		

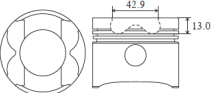
## DIESEL

ENGINE TYPE	LINER KIT	CYL. LINER	PISTON + RINGS			PISTON SET	RINGS SET	PIN
Motor typ Type de Moteur Tipo de motor Тип двигателя	Liner Kit Kit de Chemise Camisas de los cilindros лайнер комплект	Zylinderlaufbuchse Chemise Camisas de los cilindros втулка цилиндра	Kolben + Ringe Piston + Segments Pistón Set Поршень и кольца			Kolben Set Set de Piston Pistón Set поршневой	Kolben Set Segments de Piston Anillos Set кольца	Pin Axe Perno Пин
<b>OM 628</b> 8 Cyl 86.0 mm Bore Ø 3,996 cc	<b>M-0040290</b> <b>M-0040200</b> <b>G-0813630000</b> <b>M-00401N0</b> <b>M-001WN20</b>	Length: 151.0 Outside Ø: 92.0 Flange Ø: 96.0 collar depth 58.02	Length: 68.25 Comp: 42.25 Height: -13.0			alfin and with oil gallery skirt MOS2 treated	Top: 2.5 2nd: 2.0 3rd: 3.0 1st oil: 2nd oil:	Ø: 30.0 Length: 68.0
			Reference no.:	Reference no.:	Reference no.:	Reference no.:	O-RING	
							<b>ORMB80434DB</b>	
NM-Germany Article no. Artikelnummer/ Modelo Número / статья НОМЕР	NM-Germany Article no.	NM-Germany Article no.	NM-Germany Article no.	NM-Germany Article no.	NM-Germany Article no.	NM-Germany Article no.	NM-Germany Article no.	
	<b>LBSMB80434DFB</b> (for cyl 5/6/7/8)	<b>LBMB80434DFB</b>	<b>KBSMB80434DB</b> (for cyl 5/6/7/8)	<b>KBMB80434DB</b> (for cyl 5/6/7/8)	<b>KBMB80434DB</b> (for cyl 5/6/7/8)	<b>KRMB80434DB</b>		



**GASOLINE**

ENGINE TYPE Motortyp Type de Moteur Tipo de motor Тип двигателя	LINER KIT Liner Kit Kit de Chemise Camisas de los cilindros лайнер комплект	CYL. LINER Zylinderlaufbuchse Chemise Camisas de los cilindros втулка цилиндра	PISTON + RINGS Kolben + Ringe Piston + Segments Pistón Set Поршень и кольца		PISTON SET Kolben Set Set de Piston Pistón Set поршневой	RINGS SET Kolben Set Segments de Piston Anillos Set кольца	PIN Pin Axe Perno Пин
<b>M110</b> 6 Cyl 86.0 mm Bore Ø 2,746 cc		Length: Outside Ø: Flange Ø: flange depth	Length:	76.48	75.68	Top: 1.75 2nd: 2.5 3rd: 4.0 1st oil: 2nd oil:	Ø: 23.0 Length: 69.0
			Comp:	42.8	42.0		
			Height:	+1.7	+1.7		
		Reference no.:	Reference no.:	Reference no.:	Reference no.:	O-RING	
			<b>K-92594600</b> <b>M-0023700</b>	<b>110 030 28 17</b> <b>110 030 54 17</b> <b>110 030 72 17</b> <b>110 030 75 17</b>	<b>G-0817660000</b> <b>K-800016963000</b> <b>M-00235N0</b>		
NM-Germany Article no. Artikelnummer/ Modelo Número / статья НОМЕР	NM-Germany Article no.	NM-Germany Article no.	NM-Germany Article no.	NM-Germany Article no.	NM-Germany Article no.	NM-Germany Article no.	
			<b>KBSMB60438G</b>	<b>KBMB60438G</b>	<b>KRMB60438G</b>		

**GASOLINE**

ENGINE TYPE Motortyp Type de Moteur Tipo de motor Тип двигателя	LINER KIT Liner Kit Kit de Chemise Camisas de los cilindros лайнер комплект	CYL. LINER Zylinderlaufbuchse Chemise Camisas de los cilindros втулка цилиндра	PISTON + RINGS Kolben + Ringe Piston + Segments Pistón Set Поршень и кольца		PISTON SET Kolben Set Set de Piston Pistón Set поршневой	RINGS SET Kolben Set Segments de Piston Anillos Set кольца	PIN Pin Axe Perno Пин
<b>M103</b> 6 Cyl 86.5 mm Bore Ø 2,778 cc		Length: Outside Ø: Flange Ø: flange depth	Length:	81.2		Top: 2.0 2nd: 2.0 3rd: 2.5 1st oil: 4.0 2nd oil:	Ø: 25.0 Length: 75.4
			Comp:	49.2			
			Height:	0			
		Reference no.:	Reference no.:	Reference no.:	Reference no.:	O-RING	
NM-Germany Article no. Artikelnummer/ Modelo Número / статья НОМЕР	NM-Germany Article no.	NM-Germany Article no.	NM-Germany Article no.	NM-Germany Article no.	NM-Germany Article no.	NM-Germany Article no.	
			<b>KBSMB60439G</b>	<b>KBMB60439G</b>	<b>KRMB60439G</b>		

**GASOLINE**

ENGINE TYPE Motortyp Type de Moteur Tipo de motor Тип двигателя	LINER KIT Liner Kit Kit de Chemise Camisas de los cilindros лайнер комплект	CYL. LINER Zylinderlaufbuchse Chemise Camisas de los cilindros втулка цилиндра	PISTON + RINGS Kolben + Ringe Piston + Segments Pistón Set Поршень и кольца		PISTON SET Kolben Set Set de Piston Pistón Set поршневой	RINGS SET Kolben Set Segments de Piston Anillos Set кольца	PIN Pin Axe Perno Пин
<b>M130</b> 6 Cyl 86.5 mm Bore Ø 2,778 cc		Length: Outside Ø: Flange Ø: flange depth	Length:	81.2	80.6	Top: 2.0 2nd: 2.5 3rd: 4.0 1st oil: 2nd oil:	Ø: 25.0 Length: 74.8
			Comp:	49.2	48.6		
			Height:	-1.3	-1.3		
		Reference no.:	Reference no.:	Reference no.:	Reference no.:	O-RING	
			<b>K-91427600</b> <b>M-0017500</b>	<b>130 030 01 18</b> <b>130 030 04 18</b> <b>130 030 13 17</b> <b>130 030 17 17</b> <b>130 030 21 17</b> <b>130 030 34 17</b> <b>130 030 44 17</b> <b>130 030 54 17</b> <b>130 030 59 17</b> <b>130 030 68 17</b> <b>130 030 74 17</b> <b>130 030 84 17</b> <b>130 030 92 17</b> <b>130 030 95/98 17</b>	<b>G-0818150010</b>		
NM-Germany Article no. Artikelnummer/ Modelo Número / статья НОМЕР	NM-Germany Article no.	NM-Germany Article no.	NM-Germany Article no.	NM-Germany Article no.	NM-Germany Article no.	NM-Germany Article no.	
			<b>KBSMB60440G</b>	<b>KBMB60440G</b>	<b>KRMB60440G</b>		

## DIESEL



ENGINE TYPE Motortyp Type de Moteur Tipo de motor Тип двигателя	LINER KIT Liner Kit Kit de Chemise Camisas de los cilindros лайнер комплект	CYL. LINER Zylinderlaufbuchse Chemise Camisas de los cilindros втулка цилиндра	PISTON + RINGS Kolben + Ringe Piston + Segments Pistón Set Поршень и кольца	PISTON SET Kolben Set Set de Piston Pistón Set поршневой	RINGS SET Kolben Set Anillos Set Segments de Piston кольца	PIN Pin Axe Perno Пин
<b>OM 601</b> <b>OM 602</b> <b>OM 603</b> 4/5/6 Cyl 87.0 mm Bore Ø 1,997 cc 2,497 cc 2,996 cc	(A) <b>K-94330960</b> <b>M-0029390</b> <b>N-8874360010</b> consists of (C) (B) <b>M-0029392</b> consists of (D)	Length: 148.6 148.6 Outside Ø: 90.0 90.3 Flange Ø: 92.6 92.6 flange depth 4.7 4.7	Length: 74.85 Comp: 44.85 Height: -4.4 -9.05	alfin skirt MOS2 treated	Top: 2.5 2nd: 2.0 3rd: 3.0 1st oil: 2nd oil:	Ø: 26.0 Length: 55.0
		Reference no.:	Reference no.:	Reference no.:	Reference no.:	O-RING
		(C) <b>601 011 00 10</b> <b>G-1402624000</b> <b>K-89193190</b> <b>M-001WV09</b> (D) <b>M-001WV13</b>	<b>K-94330600</b> <b>M-0029300</b> <b>N-8874360010</b>	<b>601 030 07 17</b> <b>601 030 08 17</b> <b>601 030 11 17</b> <b>601 030 15 17</b> <b>601 030 17 17</b> <b>601 030 20 17</b> <b>601 030 22 17</b> <b>601 037 08/14 01</b> <b>601 037 15 01/19</b> <b>601 037 19 01</b> <b>603 030 00 17</b>	<b>A-R48040</b> <b>G-0874360000</b> <b>K-800017311000</b> <b>M-00293N0</b>	
NM-Germany Article no. Artikelnummer/ Modelo Número / статья НОМЕР	NM-Germany Article no.	NM-Germany Article no.	NM-Germany Article no.	NM-Germany Article no.	NM-Germany Article no.	NM-Germany Article no.
	LBSMB45604411DSA (A) LBSMB45604412DSA (B)	LBMB45604411DS (C) LBMB45604412DS (D)	KBSMB4560441DA	KBMB4560441DA	KRMB4560441D	

## DIESEL



ENGINE TYPE Motortyp Type de Moteur Tipo de motor Тип двигателя	LINER KIT Liner Kit Kit de Chemise Camisas de los cilindros лайнер комплект	CYL. LINER Zylinderlaufbuchse Chemise Camisas de los cilindros втулка цилиндра	PISTON + RINGS Kolben + Ringe Piston + Segments Pistón Set Поршень и кольца	PISTON SET Kolben Set Set de Piston Pistón Set поршневой	RINGS SET Kolben Set Anillos Set Segments de Piston кольца	PIN Pin Axe Perno Пин
<b>OM 602 TURBO</b> <b>OM 603 TURBO</b> 5/6 Cyl 87.0 mm Bore Ø 2,497 cc 2,996 cc	(A) <b>K-90016961</b> <b>M-0022392</b> consists of (C) (B) <b>M-0022393</b> consists of (D)	Length: 148.6 148.6 Outside Ø: 90.0 90.3 Flange Ø: 92.6 92.6 flange depth 4.7 4.7	Length: 74.8 Comp: 44.8 Height: -9.0	alfin and with oil gallery head anodized skirt MOS2 treated	Top: 2.5 2nd: 2.0 3rd: 3.0 1st oil: 2nd oil:	Ø: 28.0 Length: 70.0
		Reference no.:	Reference no.:	Reference no.:	Reference no.:	O-RING
		(C) <b>601 011 00 10</b> <b>G-1402624000</b> <b>K-89193190</b> <b>M-001WV09</b> (D) <b>M-001WV13</b>	<b>K-90016600</b> <b>M-0022300</b> <b>N-8718330000</b>	<b>602 030 00 17</b> <b>602 037 00 01</b> <b>603 030 09 17</b> <b>603 030 10 17</b> <b>603 030 13 17</b>	<b>A-R48040</b> <b>G-0874360000</b> <b>K-800017311000</b> <b>M-00293N0</b>	
NM-Germany Article no. Artikelnummer/ Modelo Número / статья НОМЕР	NM-Germany Article no.	NM-Germany Article no.	NM-Germany Article no.	NM-Germany Article no.	NM-Germany Article no.	NM-Germany Article no.
	LBSMB5604421DSB (A) LBSMB5604422DSB (B)	LBMB5604421DS (C) LBMB5604422DS (D)	KBSMB560442DB	KBMB560442DB	KRMB560442D	

## DIESEL

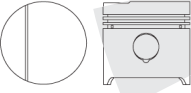

ENGINE TYPE Motortyp Type de Moteur Tipo de motor Тип двигателя	LINER KIT Liner Kit Kit de Chemise Camisas de los cilindros лайнер комплект	CYL. LINER Zylinderlaufbuchse Chemise Camisas de los cilindros втулка цилиндра	PISTON + RINGS Kolben + Ringe Piston + Segments Pistón Set Поршень и кольца	PISTON SET Kolben Set Set de Piston Pistón Set поршневой	RINGS SET Kolben Set Anillos Set Segments de Piston кольца	PIN Pin Axe Perno Пин
<b>OM 604</b> <b>OM 605</b> <b>OM 606</b> 4/5/6 Cyl 87.0 mm Bore Ø 1,997 cc 2,497 cc 2,996 cc	(A) <b>K-94819970</b> <b>M-0023090</b> consists of (C) (B) <b>M-0023092</b> consists of (D)	Length: 148.6 148.6 Outside Ø: 90.0 90.3 Flange Ø: 92.6 92.6 flange depth 4.7 4.7	Length: 76.22 Comp: 44.9 Height: +1.32 -2.7	alfin top ring land and skirt MOS2 treated	Top: 2.5 2nd: 2.0 3rd: 3.0 1st oil: 2nd oil:	Ø: 26.0 Length: 55.0
		Reference no.:	Reference no.:	Reference no.:	Reference no.:	O-RING
		(C) <b>601 011 00 10</b> <b>G-1402624000</b> <b>K-89193190</b> <b>M-001WV09</b> (D) <b>M-001WV13</b>	<b>K-94819700</b> <b>M-00230000</b> <b>N-8774360000</b>	<b>606 030 06 17</b>	<b>A-R48040</b> <b>G-0874360000</b> <b>K-800017311000</b> <b>M-00293N0</b>	
NM-Germany Article no. Artikelnummer/ Modelo Número / статья НОМЕР	NM-Germany Article no.	NM-Germany Article no.	NM-Germany Article no.	NM-Germany Article no.	NM-Germany Article no.	NM-Germany Article no.
	LBSMB45604431DSA (A) LBSMB45604432DSA (B)	LBMB45604431DS (C) LBMB45604432DS (D)	KBSMB4560443DA	KBMB4560443DA	KRMB4560443D	

ENGINE TYPE	LINER KIT	CYL. LINER	PISTON + RINGS		PISTON SET	RINGS SET	PIN
Motorotyp Type de Moteur Tipo de motor Тип двигателя	Liner Kit Kit de Chemise Camisas de los cilindros лайнер комплект	Zylinderlaufbuchse Chemise Camisas de los cilindros втулка цилиндра	Kolben + Ringe Piston + Segments Pistón Set Поршень и кольца		Kolben Set Set de Piston Pistón Set поршневой	Kolben Set Segments de Piston Anillos Set кольца	Pin Axe Perno Пин
<b>OM 605 TURBO</b> <b>OM 606 TURBO</b> 5/6 Cyl 87.0 mm Bore Ø 2,497 cc 2,996 cc	(A) <b>K-94820970</b> <b>M-0010290</b> consists of (C)  (B) <b>M-0010292</b> consists of (D)	(C) (D) Length: 148.6 148.6 Outside Ø: 90.0 90.3 Flange Ø: 92.6 92.6 flange depth 4.7 4.7	Length: 76.22 Comp: 44.87 Height: +1.3 -4.6		alfin and with oil gallery head anodized skirt MOS2 treated	Top: 2.5 2nd: 2.0 3rd: 3.0 1st oil: 2nd oil:	Ø: 28.0 Length: 70.0
		Reference no.:	Reference no.:	Reference no.:	Reference no.:	O-RING	
		(C) <b>601 011 00 10</b> <b>G-1402624000</b> <b>K-89193190</b> <b>M-001WV09</b>  (D) <b>M-001WV13</b>	<b>K-94820700</b> <b>M-0010200</b>	<b>605 030 00 17</b> <b>605 030 01 17</b> <b>605 030 02 17</b> <b>605 030 04 17</b> <b>605 037 00 01</b>	<b>A-R48040</b> <b>G-0874360000</b> <b>K-800017311000</b> <b>M-00293N0</b>		
NM-Germany Article no. Artikelnummer/ Modelo Número / статья НОМЕР	NM-Germany Article no.	NM-Germany Article no.	NM-Germany Article no.	NM-Germany Article no.	NM-Germany Article no.	NM-Germany Article no.	NM-Germany Article no.
	(A) <b>LBSMB5604441DSB</b>  (B) <b>LBSMB5604442DSB</b>	<b>LBMB5604441DS (C)</b> <b>LBMB5604442DS (D)</b>	<b>KBSMB560444DB</b>	<b>KBMB560444DB</b>	<b>KRMB560444D</b>		

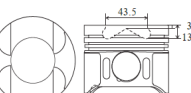

## GASOLINE

ENGINE TYPE	LINER KIT	CYL. LINER	PISTON + RINGS		PISTON SET	RINGS SET	PIN
Motorotyp Type de Moteur Tipo de motor Тип двигателя	Liner Kit Kit de Chemise Camisas de los cilindros лайнер комплект	Zylinderlaufbuchse Chemise Camisas de los cilindros втулка цилиндра	Kolben + Ringe Piston + Segments Pistón Set Поршень и кольца		Kolben Set Set de Piston Pistón Set поршневой	Kolben Set Segments de Piston Anillos Set кольца	Pin Axe Perno Пин
<b>M115</b> 4 Cyl 87.0 mm Bore Ø 2,197 cc			STD O/S Length: 88.0 87.2 Comp: 48.0 47.2 Height: -2.0 -2.0			Top: 2.0 2nd: 2.5 3rd: 4.0 1st oil: 2nd oil:	Ø: 26.0 Length: 72.0
		Reference no.:	Reference no.:	Reference no.:	Reference no.:	O-RING	
			<b>K-91428600</b> <b>M-0018300</b>		<b>G-0817730010</b> <b>K-800010641000</b> <b>M-00183N0</b>		
NM-Germany Article no. Artikelnummer/ Modelo Número / статья НОМЕР	NM-Germany Article no.	NM-Germany Article no.	NM-Germany Article no.	NM-Germany Article no.	NM-Germany Article no.	NM-Germany Article no.	NM-Germany Article no.
			<b>KBSMB40445G</b>	<b>KBMB40445G</b>	<b>KRMB40445G</b>		

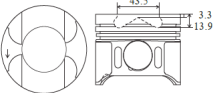

## DIESEL

ENGINE TYPE	LINER KIT	CYL. LINER	PISTON + RINGS		PISTON SET	RINGS SET	PIN
Motorotyp Type de Moteur Tipo de motor Тип двигателя	Liner Kit Kit de Chemise Camisas de los cilindros лайнер комплект	Zylinderlaufbuchse Chemise Camisas de los cilindros втулка цилиндра	Kolben + Ringe Piston + Segments Pistón Set Поршень и кольца		Kolben Set Set de Piston Pistón Set поршневой	Kolben Set Segments de Piston Anillos Set кольца	Pin Axe Perno Пин
<b>OM 611</b> <b>OM 612</b> <b>OM 613</b> 4/5/6 Cyl 88.0 mm Bore Ø 2,151 cc 2,686 cc 3,222 cc		Length: 149.5 Outside Ø: 91.0 Flange Ø: 92.5 flange depth 4.7	Length: 72.3 Comp: 42.3 Height: -3.3 -13.9		alfin and with oil gallery skirt MOS2 treated fits straight con. rod	Top: 2.5 2nd: 2.0 3rd: 3.0 1st oil: 2nd oil:	Ø: 30.0 Length: 70.0
		Reference no.:	Reference no.:	Reference no.:	Reference no.:	O-RING	
			<b>K-97409600</b> <b>M-0045700</b> <b>N-8711790000</b>	<b>613 030 01 17</b> <b>613 030 02 17</b>	<b>611 030 00 24</b> <b>A-R60400</b> <b>G-0811790000</b> <b>K-800048010000</b> <b>K-800073420000</b> <b>M-00136N0</b>		
NM-Germany Article no. Artikelnummer/ Modelo Número / статья НОМЕР	NM-Germany Article no.	NM-Germany Article no.	NM-Germany Article no.	NM-Germany Article no.	NM-Germany Article no.	NM-Germany Article no.	NM-Germany Article no.
	<b>LB-SMB4560446DSB</b>	<b>LBMB4560446DSB</b>	<b>KBSMB4560446DB</b>	<b>KBMB4560446DB</b>	<b>KRMB4560446DB</b>		

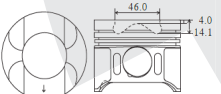

**DIESEL**

ENGINE TYPE Motortyp Type de Moteur Tipo de motor Тип двигателя	LINER KIT Liner Kit Kit de Chemise Camisas de los cilindros лайнер комплект	CYL. LINER Zylinderlaufbuchse Chemise Camisas de los cilindros втулка цилиндра	PISTON + RINGS Kolben + Ringe Piston + Segments Pistón Set Поршень и кольца	PISTON SET Kolben Set Set de Piston Pistón Set поршневой	RINGS SET Kolben Set Segments de Piston Anillos Set кольца	PIN Pin Axe Perno Пин	
<b>OM 611 New</b> <b>OM 612 New</b> <b>OM 613 New</b> 4/5/6 Cyl 88.0 mm Bore Ø 2,151 cc 2,686 cc 3,222 cc 		Length: 149.5 Outside Ø: 91.0 Flange Ø: 92.5 flange depth 4.7	Length: 72.3 Comp: 42.3 Height: -3.3 -13.9	alfin and with oil gallery skirt MOS2 treated fits tapered con. rod	Top: 2.5 2nd: 2.0 3rd: 3.0 1st oil: 3.0 2nd oil:	Ø: 30.0 Length: 70.0	
		Reference no.:	Reference no.:		Reference no.:	Reference no.:	O-RING
			<b>M-0045600</b> <b>N-8711790020</b>		<b>611 030 03 17</b> <b>611 030 05 17</b> <b>611 030 07 17</b> <b>611 030 11 17</b> <b>611 030 12 17</b> <b>611 030 14 17</b> <b>612 030 04 17</b>	<b>611 030 00 24</b> <b>A-R60400</b> <b>G-0811790000</b> <b>K-800048010000</b> <b>K-800073420000</b> <b>M-00136N0</b>	
NM-Germany Article no. Artikelnummer/ Modelo Número / статья НОМЕР	NM-Germany Article no.	NM-Germany Article no.	NM-Germany Article no.	NM-Germany Article no.	NM-Germany Article no.	NM-Germany Article no.	
	LB-SMB4560447DSB	LBMB4560447DSB	KBSMB4560447DB	KBMB4560447DB	KRMB4560447DB		

**DIESEL**

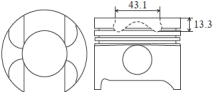

ENGINE TYPE Motortyp Type de Moteur Tipo de motor Тип двигателя	LINER KIT Liner Kit Kit de Chemise Camisas de los cilindros лайнер комплект	CYL. LINER Zylinderlaufbuchse Chemise Camisas de los cilindros втулка цилиндра	PISTON + RINGS Kolben + Ringe Piston + Segments Pistón Set Поршень и кольца	PISTON SET Kolben Set Set de Piston Pistón Set поршневой	RINGS SET Kolben Set Segments de Piston Anillos Set кольца	PIN Pin Axe Perno Пин	
<b>OM 646</b> <b>OM 647</b> <b>OM 648</b> 4/5/6 Cyl 88.0 mm Bore Ø 2,151 cc 2,685 cc 3,227 cc 		Length: 149.5 Outside Ø: 91.0 Flange Ø: 92.5 flange depth 4.7	Length: 72.3 Comp: 42.3 Height: -4.0 -14.1	alfin and with oil gallery skirt MOS2 treated fits tapered con. rod	Top: 2.5 2nd: 2.0 3rd: 3.0 1st oil: 3.0 2nd oil:	Ø: 30.0 Length: 70.0	
		Reference no.:	Reference no.:		Reference no.:	Reference no.:	O-RING
			<b>K-97482600</b> <b>M-0045900</b>			<b>611 030 00 24</b> <b>A-R60400</b> <b>G-0811790000</b> <b>K-800048010000</b> <b>K-800073420000</b> <b>M-00136N0</b>	
NM-Germany Article no. Artikelnummer/ Modelo Número / статья НОМЕР	NM-Germany Article no.	NM-Germany Article no.	NM-Germany Article no.	NM-Germany Article no.	NM-Germany Article no.	NM-Germany Article no.	
	LB-SMB4560448DSB	LBMB4560448DSB	KBSMB4560448DB	KBMB4560448DB	KRMB4560448DB		

**DIESEL**



ENGINE TYPE Motortyp Type de Moteur Tipo de motor Тип двигателя	LINER KIT Liner Kit Kit de Chemise Camisas de los cilindros лайнер комплект	CYL. LINER Zylinderlaufbuchse Chemise Camisas de los cilindros втулка цилиндра	PISTON + RINGS Kolben + Ringe Piston + Segments Pistón Set Поршень и кольца	PISTON SET Kolben Set Set de Piston Pistón Set поршневой	RINGS SET Kolben Set Segments de Piston Anillos Set кольца	PIN Pin Axe Perno Пин	
<b>OM 611</b> 4 Cyl 88.0 mm Bore Ø 2,151 cc 		Length: 149.5 Outside Ø: 91.0 Flange Ø: 92.5 flange depth 4.7	Length: 72.3 Comp: 42.3 Height: -13.3	alfin and with oil gallery	Top: 2.5 2nd: 2.0 3rd: 3.0 1st oil: 3.0 2nd oil:	Ø: 28.0 Length: 68.0	
		Reference no.:	Reference no.:		Reference no.:	Reference no.:	O-RING
			<b>M-0013600</b> <b>N-8711790010</b>			<b>611 030 00 24</b> <b>A-R60400</b> <b>G-0811790000</b> <b>K-800048010000</b> <b>K-800073420000</b> <b>M-00136N0</b>	
NM-Germany Article no. Artikelnummer/ Modelo Número / статья НОМЕР	NM-Germany Article no.	NM-Germany Article no.	NM-Germany Article no.	NM-Germany Article no.	NM-Germany Article no.	NM-Germany Article no.	
	LBSMB40449DSB	LBMB40449DSB	KBSMB40449DB	KBMB40449DB	KRMB40449DB		

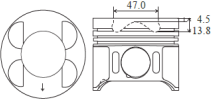



## DIESEL

ENGINE TYPE Motortyp Type de Moteur Tipo de motor Тип двигателя	LINER KIT Liner Kit Kit de Chemise Camisas de los cilindros лайнер комплект	CYL. LINER Zylinderlaufbuchse Chemise Camisas de los cilindros втулка цилиндра	PISTON + RINGS Kolben + Ringe Piston + Segments Pistón Set Поршень и кольца			PISTON SET Kolben Set Set de Piston Pistón Set поршневой	RINGS SET Kolben Set Segments de Piston Anillos Set кольца	PIN Pin Axe Perno Пин
<b>OM 646</b> 4 Cyl 88.0 mm Bore Ø 2,148 cc		Length: 74.3 Comp: 44.3 Height: -4.5 flange depth: -13.8	Length: 74.3 Comp: 44.3 Height: -4.5 flange depth: -13.8		alfin and with oil gallery skirt MOS2 treated fits tapered con. rod	Top: 2.5 2nd: 2.0 3rd: 3.0 1st oil: 2nd oil:	Ø: 30.0 Length: 70.0	
		Reference no.:	Reference no.:	Reference no.:	Reference no.:	O-RING		
			<b>K-40304600</b>			<b>611 030 00 24</b> <b>A-R60400</b> <b>G-0811790000</b> <b>K-800048010000</b> <b>K-800073420000</b> <b>M-00136N0</b>		
NM-Germany Article no. Artikelnummer/ Modelo Número / статья НОМЕР	NM-Germany Article no.	NM-Germany Article no.	NM-Germany Article no.	NM-Germany Article no.	NM-Germany Article no.	NM-Germany Article no.	NM-Germany Article no.	
			<b>KBSMB40450DB</b>	<b>KBMB40450DB</b>	<b>KRMB40450DB</b>			

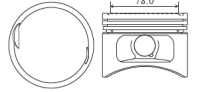

## GASOLINE

ENGINE TYPE Motortyp Type de Moteur Tipo de motor Тип двигателя	LINER KIT Liner Kit Kit de Chemise Camisas de los cilindros лайнер комплект	CYL. LINER Zylinderlaufbuchse Chemise Camisas de los cilindros втулка цилиндра	PISTON + RINGS Kolben + Ringe Piston + Segments Pistón Set Поршень и кольца			PISTON SET Kolben Set Set de Piston Pistón Set поршневой	RINGS SET Kolben Set Segments de Piston Anillos Set кольца	PIN Pin Axe Perno Пин
<b>M103</b> 6 Cyl 88.5 mm Bore Ø 2,962 cc		Length: 133.0 Outside Ø: 91.5 Flange Ø: 93.6 flange depth: 4.7	Length: 63.0 Comp: 33.0 Height: -2.7	63.0 33.0 -3.3	1.00 skirt MOS2 treated	Top: 1.5 2nd: 1.75 3rd: 3.0 1st oil: 2nd oil:	Ø: 22.0 Length: 52.0	
		Reference no.:	Reference no.:	Reference no.:	Reference no.:	O-RING		
		<b>K-89506190</b>	<b>K-93810600</b> <b>M-0021900</b> <b>N-8718300000</b>	<b>103 030 01 18</b> <b>103 030 13 17</b> <b>103 030 20 19</b> <b>103 030 21 17</b> <b>103 030 37 17</b> <b>103 030 41 18</b> <b>103 030 45 17</b> <b>103 030 49 17</b> <b>103 030 53 17</b> <b>103 030 49 18</b> <b>103 030 69 18</b> <b>103 030 80 18</b>		<b>G-0818300000</b> <b>K-800017660000</b> <b>M-00219V0</b>		
NM-Germany Article no. Artikelnummer/ Modelo Número / статья НОМЕР	NM-Germany Article no.	NM-Germany Article no.	NM-Germany Article no.	NM-Germany Article no.	NM-Germany Article no.	NM-Germany Article no.	NM-Germany Article no.	
	<b>LBSMB60451GS</b>	<b>LBMB60451GS</b>	<b>KBSMB60451G</b>	<b>KBMB60451G</b>	<b>KRMB60451G</b>			

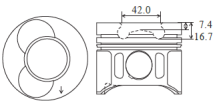

## GASOLINE

ENGINE TYPE Motortyp Type de Moteur Tipo de motor Тип двигателя	LINER KIT Liner Kit Kit de Chemise Camisas de los cilindros лайнер комплект	CYL. LINER Zylinderlaufbuchse Chemise Camisas de los cilindros втулка цилиндра	PISTON + RINGS Kolben + Ringe Piston + Segments Pistón Set Поршень и кольца			PISTON SET Kolben Set Set de Piston Pistón Set поршневой	RINGS SET Kolben Set Segments de Piston Anillos Set кольца	PIN Pin Axe Perno Пин
<b>M103</b> 6 Cyl 88.5 mm Bore Ø 2,962 cc		Length: 133.0 Outside Ø: 91.5 Flange Ø: 93.6 flange depth: 4.7	Length: 66.0 Comp: 33.0 Height: -0.6	66.0 33.0 -0.8	1.00	Top: 1.5 2nd: 1.75 3rd: 3.0 1st oil: 2nd oil:	Ø: 22.0 Length: 52.0	
		Reference no.:	Reference no.:	Reference no.:	Reference no.:	O-RING		
		<b>K-89506190</b>	<b>K-91819600</b> <b>M-0022700</b>	<b>103 030 16 19</b> <b>103 030 29 18</b> <b>103 037 29 02</b>		<b>G-0818300000</b> <b>K-800017660000</b> <b>M-00219V0</b>		
NM-Germany Article no. Artikelnummer/ Modelo Número / статья НОМЕР	NM-Germany Article no.	NM-Germany Article no.	NM-Germany Article no.	NM-Germany Article no.	NM-Germany Article no.	NM-Germany Article no.	NM-Germany Article no.	
	<b>LBSMB60452GS</b>	<b>LBMB60452GS</b>	<b>KBSMB60452G</b>	<b>KBMB60452G</b>	<b>KRMB60452G</b>			



## DIESEL

ENGINE TYPE Motortyp Type de Moteur Tipo de motor Тип двигателя	LINER KIT Liner Kit Kit de Chemise Camisas de los cilindros лайнер комплект	CYL. LINER Zylinderlaufbuchse Chemise Camisas de los cilindros втулка цилиндра	PISTON + RINGS Kolben + Ringe Piston + Segments Pistón Set Поршень и кольца		PISTON SET Kolben Set Set de Piston Pistón Set поршневой	RINGS SET Kolben Set Segments de Piston Anillos Set кольца	PIN Pin Axe Perno Пин
<b>OM 602 TURBO</b> <b>5 Cyl</b> <b>89.0 mm Bore Ø</b> <b>2,874 cc</b>	<b>K-94823970</b> <b>M-0010192</b>	Length: 156.5 Outside Ø: 91.5 Flange Ø: 94.0 flange depth 4.7	Length: 74.75 Comp: 44.75 Height: -7.4 -16.7		alfin and with oil gallery skirt MOS2 treated	Top: 2.5	Ø: 28.0 Length: 70.0
						2nd: 2.0	
						3rd: 3.0 1st oil: 2nd oil:	
	<b>Reference no.:</b>	<b>Reference no.:</b>	<b>Reference no.:</b>	<b>Reference no.:</b>	<b>O-RING</b>		
	<b>G-1402721000</b> <b>K-89456190</b> <b>M-004WV14</b>	<b>K-94823700</b> <b>M-0010100</b> <b>N-8774310000</b>	<b>602 030 05 17</b> <b>602 030 06 17</b> <b>602 030 07 17</b> <b>602 030 08 17</b> <b>602 030 09 17</b> <b>602 030 10 17</b>	<b>A-R45080</b> <b>G-0874310000</b> <b>K-800017810000</b> <b>M-00224N0</b>			
NM-Germany Article no. Artikelnummer/ Modelo Número / статья НОМЕР	NM-Germany Article no.	NM-Germany Article no.	NM-Germany Article no.	NM-Germany Article no.	NM-Germany Article no.	NM-Germany Article no.	
	<b>LBSMB50453DSB</b>	<b>LBMB50453DSB</b>	<b>KBSMB50453DB</b>	<b>KBMB50453DB</b>	<b>KRMB50453DB</b>		

## DIESEL

ENGINE TYPE Motortyp Type de Moteur Tipo de motor Тип двигателя	LINER KIT Liner Kit Kit de Chemise Camisas de los cilindros лайнер комплект	CYL. LINER Zylinderlaufbuchse Chemise Camisas de los cilindros втулка цилиндра	PISTON + RINGS Kolben + Ringe Piston + Segments Pistón Set Поршень и кольца		PISTON SET Kolben Set Set de Piston Pistón Set поршневой	RINGS SET Kolben Set Segments de Piston Anillos Set кольца	PIN Pin Axe Perno Пин
<b>OM 601/OM 661</b> <b>OM 602/OM 662</b> <b>4/5 Cyl</b> <b>89.0 mm Bore Ø</b> <b>2,299 cc 2,874 cc</b>	(A) <b>K-91372961</b> <b>M-0022492</b> consists of (C)  (B) <b>K-91372960</b> <b>M-0022490</b> consists of (D)	Length: 156.5 156.5 Outside Ø: 91.5 91.5 Flange Ø: 94.0 96.5 flange depth 4.7 4.7	Length: 74.6 Comp: 44.6 Height: -8.9		alfin skirt MOS2 treated	Top: 2.5	Ø: 26.0 Length: 62.0
						2nd: 2.0	
						3rd: 3.0 1st oil: 2nd oil:	
	<b>Reference no.:</b>	<b>Reference no.:</b>	<b>Reference no.:</b>	<b>Reference no.:</b>	<b>O-RING</b>		
	(C) <b>G-1402721000</b> <b>K-89456190</b> <b>M-004WV14</b>	<b>K-91372600</b> <b>M-0022400</b> <b>N-8774310010</b>	<b>601 030 13 17</b> <b>601 030 18 17</b> <b>601 037 17 01</b> <b>601 037 18 01</b>	<b>A-R45080</b> <b>G-0874310000</b> <b>K-800017810000</b> <b>M-00224N0</b>			
	(B) <b>A-SU351337</b> <b>G-1402638000</b> <b>K-89429190</b> <b>M-002WV04</b>						
NM-Germany Article no. Artikelnummer/ Modelo Número / статья НОМЕР	NM-Germany Article no.	NM-Germany Article no.	NM-Germany Article no.	NM-Germany Article no.	NM-Germany Article no.	NM-Germany Article no.	
	(A) <b>LBSMB4504541DSA</b> (B) <b>LBSMB4504542DSA</b>	<b>LBMB4504541DS (C)</b> <b>LBMB4504542DS (B)</b>	<b>KBSMB450454DB</b>	<b>KBMB450454DB</b>	<b>KRMB450454DB</b>		

## DIESEL

ENGINE TYPE Motortyp Type de Moteur Tipo de motor Тип двигателя	LINER KIT Liner Kit Kit de Chemise Camisas de los cilindros лайнер комплект	CYL. LINER Zylinderlaufbuchse Chemise Camisas de los cilindros втулка цилиндра	PISTON + RINGS Kolben + Ringe Piston + Segments Pistón Set Поршень и кольца		PISTON SET Kolben Set Set de Piston Pistón Set поршневой	RINGS SET Kolben Set Segments de Piston Anillos Set кольца	PIN Pin Axe Perno Пин
<b>OM 601 TURBO</b> <b>OM 603 TURBO</b> <b>4/6 Cyl</b> <b>89.0 mm Bore Ø</b> <b>2,299 cc 3,449 cc</b>	<b>M-0013390</b>	Length: 156.5 Outside Ø: 91.5 Flange Ø: 94.0 flange depth 4.7	Length: 74.6 Comp: 44.6 Height: -9.0		alfin and with oil gallery head anodized skirt MOS2 treated	Top: 2.5	Ø: 28.0 Length: 70.0
						2nd: 2.0	
						3rd: 3.0 1st oil: 2nd oil:	
	<b>Reference no.:</b>	<b>Reference no.:</b>	<b>Reference no.:</b>	<b>Reference no.:</b>	<b>O-RING</b>		
	<b>G-1402721000</b> <b>K-89456190</b> <b>M-004WV14</b>	<b>M-0013300</b> <b>N-8774310040</b>	<b>603 030 16 17</b> <b>603 030 18 17</b> <b>603 030 19 17</b> <b>603 030 21 17</b> <b>603 037 05 01</b>	<b>A-R45080</b> <b>G-0874310000</b> <b>K-800017810000</b> <b>M-00224N0</b>			
NM-Germany Article no. Artikelnummer/ Modelo Número / статья НОМЕР	NM-Germany Article no.	NM-Germany Article no.	NM-Germany Article no.	NM-Germany Article no.	NM-Germany Article no.	NM-Germany Article no.	
	<b>LBSMB460455DSB</b>	<b>LBMB460455DSB</b>	<b>KBSMB460455DB</b>	<b>KBMB460455DB</b>	<b>KRMB460455DB</b>		

## DIESEL

ENGINE TYPE Motortyp Type de Moteur Tipo de motor Тип двигателя	LINER KIT Liner Kit Kit de Chemise Camisas de los cilindros лайнер комплект	CYL. LINER Zylinderlaufbuchse Chemise Camisas de los cilindros втулка цилиндра	PISTON + RINGS Kolben + Ringe Piston + Segments Pistón Set Поршень и кольца			PISTON SET Kolben Set Set de Piston Pistón Set поршневой	RINGS SET Kolben Set Segments de Piston Anillos Set кольца	PIN Pin Axe Perno Пин
<b>OM 601/OM 661</b> <b>OM 602/OM 662</b> 4/5 Cyl 89.0 mm Bore Ø 2,299 cc 2,874 cc	<b>K-94675960</b> <b>M-0022480</b>	Length: 156.5 Outside Ø: 91.5 Flange Ø: 96.5 flange depth 4.7	Length: 74.6 Comp: 44.4 Height: -8.9		alfin skirt MOS2 treated	Top: 2.5 2nd: 2.0 3rd: 3.0 1st oil: 2nd oil:	Ø: 26.0 Length: 62.0	
		Reference no.:		Reference no.:	Reference no.:	Reference no.:	O-RING	
		<b>K-8942490</b> <b>M-002WV04</b>		<b>K-94675600</b> <b>M-0022410</b>	<b>601 030 25 17</b>	<b>A-R45080</b> <b>G-0874310000</b> <b>K-800017810000</b> <b>M-00224N0</b>		
NM-Germany Article no. Artikelnummer/ Modelo Número / статья НОМЕР	NM-Germany Article no.	NM-Germany Article no.	NM-Germany Article no.	NM-Germany Article no.	NM-Germany Article no.	NM-Germany Article no.	NM-Germany Article no.	
	LBSMB450456DSA	LBMB450456DSA	KBSMB450456DA	KBMB450456DA	KRMB450456DA			



## DIESEL

ENGINE TYPE Motortyp Type de Moteur Tipo de motor Тип двигателя	LINER KIT Liner Kit Kit de Chemise Camisas de los cilindros лайнер комплект	CYL. LINER Zylinderlaufbuchse Chemise Camisas de los cilindros втулка цилиндра	PISTON + RINGS Kolben + Ringe Piston + Segments Pistón Set Поршень и кольца			PISTON SET Kolben Set Set de Piston Pistón Set поршневой	RINGS SET Kolben Set Segments de Piston Anillos Set кольца	PIN Pin Axe Perno Пин
<b>OM 604</b> 4 Cyl 89.0 mm Bore Ø 2,155 cc		Length: 156.5 Outside Ø: 91.5 Flange Ø: 94.0 flange depth 4.7	Length: 73.55 Comp: 43.55 Height: -4.55		alfin and with oil gallery skirt MOS2 treated	Top: 2.5 2nd: 2.0 3rd: 3.0 1st oil: 2nd oil:	Ø: 26.0 Length: 55.0	
		Reference no.:		Reference no.:	Reference no.:	Reference no.:	O-RING	
		<b>G-1402721000</b> <b>K-89456190</b> <b>M-004WV14</b>		<b>K-40109600</b> <b>M-00104000</b> <b>N-8774310030</b>	<b>604 030 01 17</b> <b>604 030 03 17</b> <b>604 030 04 17</b>	<b>A-R45080</b> <b>G-0874310000</b> <b>K-800017810000</b> <b>M-00224N0</b>		
NM-Germany Article no. Artikelnummer/ Modelo Número / статья НОМЕР	NM-Germany Article no.	NM-Germany Article no.	NM-Germany Article no.	NM-Germany Article no.	NM-Germany Article no.	NM-Germany Article no.	NM-Germany Article no.	
	LBSMB40457DSB	LBMB40457DSB	KBSMB40457DB	KBMB40457DB	KRMB40457DB			

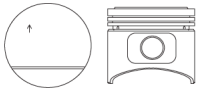

## GASOLINE

ENGINE TYPE Motortyp Type de Moteur Tipo de motor Тип двигателя	LINER KIT Liner Kit Kit de Chemise Camisas de los cilindros лайнер комплект	CYL. LINER Zylinderlaufbuchse Chemise Camisas de los cilindros втулка цилиндра	PISTON + RINGS Kolben + Ringe Piston + Segments Pistón Set Поршень и кольца			PISTON SET Kolben Set Set de Piston Pistón Set поршневой	RINGS SET Kolben Set Segments de Piston Anillos Set кольца	PIN Pin Axe Perno Пин
<b>M102</b> 4 Cyl 89.0 mm Bore Ø 1,997 cc	<b>M-0022590</b>	Length: 146.1 Outside Ø: 92.0 Flange Ø: 94.5 flange depth 4.6	Length: 74.6 73.2 72.9 Comp: 42.4 42.1 42.1 Height: +3.8 +2.7 +2.3	STD 0.50 1.00		Top: 1.75 2nd: 2.0 3rd: 3.5 1st oil: 2nd oil:	Ø: 22.0 Length: 56.0	
		Reference no.:		Reference no.:	Reference no.:	Reference no.:	O-RING	
		<b>K-89342190</b> <b>M-002WV06</b>		<b>K-91912600</b> <b>M-0022500</b>	<b>102 030 26 37</b> <b>102 030 32 38</b> <b>102 030 36 38</b> <b>102 030 57 38</b> <b>102 030 61 38</b> <b>102 030 99 18</b> <b>102 037 17 04</b>	<b>G-0817950000</b> <b>K-800017741000</b> <b>M-00215N0</b>		
NM-Germany Article no. Artikelnummer/ Modelo Número / статья НОМЕР	NM-Germany Article no.	NM-Germany Article no.	NM-Germany Article no.	NM-Germany Article no.	NM-Germany Article no.	NM-Germany Article no.	NM-Germany Article no.	
	LBSMB40458GS	LBMB40458GS	KBSMB40458G	KBMB40458G	KRMB40458G			

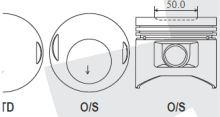

**GASOLINE**

ENGINE TYPE Motortyp Type de Moteur Tipo de motor Тип двигателя	LINER KIT Liner Kit Kit de Chemise Camisas de los cilindros лайнер комплект	CYL. LINER Zylinderlaufbuchse Chemise Camisas de los cilindros втулка цилиндра	PISTON + RINGS Kolben + Ringe Piston + Segments Pistón Set Поршень и кольца			PISTON SET Kolben Set Set de Piston Pistón Set поршневой	RINGS SET Kolben Set Segments de Piston Anillos Set кольца	PIN Pin Axe Perno Пин
<b>M102</b> 4 Cyl 89.0 mm Bore Ø 1,997 cc 	<b>K-93677960</b> <b>M-0021890</b>	Length: 146.1 Outside Ø: 92.0 Flange Ø: 94.5 flange depth 4.6	Length: 81.1 Comp: 43.1 Height: -1.9	0.50 80.8 42.8 -2.3	1.00 80.8 42.8 -2.55	Top: 1.75 2nd: 2.0 3rd: 3.5 1st oil: 2nd oil:	Ø: 22.0 Length: 56.0	
		Reference no.:	Reference no.:	Reference no.:	Reference no.:	O-RING		
		<b>K-89342190</b> <b>M-002WV06</b>	<b>K-93677600</b> <b>M-0021800</b>	<b>102 030 13 38</b> <b>102 030 16 38</b> <b>102 030 34 37</b> <b>102 030 38 37</b> <b>102 030 88 18</b> <b>102 030 92 18</b> <b>102 030 96 18</b>	<b>G-0817950000</b> <b>K-800017741000</b> <b>M-00215N0</b>			
NM-Germany Article no. Artikelnummer/ Modelo Número / статья НОМЕР	NM-Germany Article no.	NM-Germany Article no.	NM-Germany Article no.	NM-Germany Article no.	NM-Germany Article no.	NM-Germany Article no.	NM-Germany Article no.	
	LBSMB40459GS	LBMB40459GS	KBSMB40459G	KBMB40459G	KRMB40459G			

**GASOLINE**

ENGINE TYPE Motortyp Type de Moteur Tipo de motor Тип двигателя	LINER KIT Liner Kit Kit de Chemise Camisas de los cilindros лайнер комплект	CYL. LINER Zylinderlaufbuchse Chemise Camisas de los cilindros втулка цилиндра	PISTON + RINGS Kolben + Ringe Piston + Segments Pistón Set Поршень и кольца			PISTON SET Kolben Set Set de Piston Pistón Set поршневой	RINGS SET Kolben Set Segments de Piston Anillos Set кольца	PIN Pin Axe Perno Пин
<b>M102</b> 4 Cyl 89.0 mm Bore Ø 1,997 cc 	<b>K-93673970</b> <b>M-0021790</b>	Length: 146.1 Outside Ø: 92.0 Flange Ø: 94.5 flange depth 4.6	Length: 79.7 Comp: 43.2 Height: +0	0.50 79.4 42.9 -1.2	1.00 79.4 42.9 -1.6	Top: 1.75 2nd: 2.0 3rd: 3.5 1st oil: 2nd oil:	Ø: 22.0 Length: 56.0	
		Reference no.:	Reference no.:	Reference no.:	Reference no.:	O-RING		
		<b>K-89342190</b> <b>M-002WV06</b>	<b>K-93673700</b> <b>M-0021700</b> <b>M-0021720</b>	<b>102 030 02 19</b> <b>102 030 07 38</b> <b>102 030 10 38</b> <b>102 030 22 37</b> <b>103 030 30 00</b> <b>102 030 30 37</b> <b>102 030 66 37</b> <b>102 030 73 37</b> <b>102 030 76 18</b> <b>102 030 76 37</b> <b>102 030 80 18</b>	<b>G-0817950000</b> <b>K-800017741000</b> <b>M-00215N0</b>			
NM-Germany Article no. Artikelnummer/ Modelo Número / статья НОМЕР	NM-Germany Article no.	NM-Germany Article no.	NM-Germany Article no.	NM-Germany Article no.	NM-Germany Article no.	NM-Germany Article no.	NM-Germany Article no.	
	LBSMB40460GS	LBMB40460GS	KBSMB40460G	KBMB40460G	KRMB40460G			

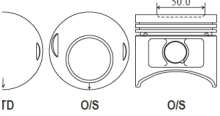
**GASOLINE**

ENGINE TYPE Motortyp Type de Moteur Tipo de motor Тип двигателя	LINER KIT Liner Kit Kit de Chemise Camisas de los cilindros лайнер комплект	CYL. LINER Zylinderlaufbuchse Chemise Camisas de los cilindros втулка цилиндра	PISTON + RINGS Kolben + Ringe Piston + Segments Pistón Set Поршень и кольца			PISTON SET Kolben Set Set de Piston Pistón Set поршневой	RINGS SET Kolben Set Segments de Piston Anillos Set кольца	PIN Pin Axe Perno Пин
<b>M102</b> 4 Cyl 89.0 mm Bore Ø 1,997 cc 	<b>K-93613970</b> <b>M-0021590</b>	Length: 146.1 Outside Ø: 92.0 Flange Ø: 94.5 flange depth 4.6	Length: 83.2 Comp: 43.2 Height: 0	0.50 82.9 42.9 -1.2	1.00 82.9 42.9 -1.6	Top: 1.75 2nd: 2.0 3rd: 3.5 1st oil: 2nd oil:	Ø: 24.0 Length: 62.0	
		Reference no.:	Reference no.:	Reference no.:	Reference no.:	O-RING		
		<b>K-89342190</b> <b>M-002WV06</b>	<b>K-93613700</b> <b>M-0021500</b> <b>N-8717950000</b>	<b>102 030 23 18</b> <b>102 030 40 18</b> <b>102 030 52 18</b> <b>102 030 79 18</b>	<b>G-0817950000</b> <b>K-800017741000</b> <b>M-00215N0</b>			
NM-Germany Article no. Artikelnummer/ Modelo Número / статья НОМЕР	NM-Germany Article no.	NM-Germany Article no.	NM-Germany Article no.	NM-Germany Article no.	NM-Germany Article no.	NM-Germany Article no.	NM-Germany Article no.	
	LBSMB40461GS	LBMB40461GS	KBSMB40461G	KBMB40461G	KRMB40461G			

**GASOLINE**



ENGINE TYPE Motortyp Type de Moteur Tipo de motor Тип двигателя	LINER KIT Liner Kit Kit de Chemise Camisas de los cilindros лайнер комплект	CYL. LINER Zylinderlaufbuchse Chemise Camisas de los cilindros втулка цилиндра	PISTON + RINGS Kolben + Ringe Piston + Segments Pistón Set Поршень и кольца			PISTON SET Kolben Set Set de Piston Pistón Set поршневой	RINGS SET Kolben Set Segments de Piston Anillos Set кольца	PIN Pin Axe Perno Пин
<b>M111</b> O/S Cyl 89.9 mm Bore Ø 1,998 cc		Length: Outside Ø: Flange Ø: flange depth	STD	O/S		skirt MOS2 treated	Top: 1.5 2nd: 1.75 3rd: 3.0 1st oil: 2nd oil:	Ø: -0.5 Length: 22.0
			56.65	56.35				
			Comp: 31.65	31.35				
		Height: +0	56.0					
		Reference no.:	Reference no.:	Reference no.:	Reference no.:	O-RING		
			<b>K-94362601</b> <b>M-0030600</b>	<b>111 030 34 17</b> <b>111 030 90 17</b>		<b>112 030 01 24</b> <b>112 030 03 24</b> <b>G-0828750000</b> <b>K-800017921000</b> <b>M-00140N0</b>		
NM-Germany Article no. Artikelnummer/ Modelo Número / статья НОМЕР	NM-Germany Article no.	NM-Germany Article no.	NM-Germany Article no.	NM-Germany Article no.	NM-Germany Article no.	NM-Germany Article no.	NM-Germany Article no.	
			<b>KBSMBOS0462G</b>	<b>KBMBOS0462G</b>	<b>KRMBOS0462G</b>			

ENGINE TYPE Motortyp Type de Moteur Tipo de motor Тип двигателя	LINER KIT Liner Kit Kit de Chemise Camisas de los cilindros лайнер комплект	CYL. LINER Zylinderlaufbuchse Chemise Camisas de los cilindros втулка цилиндра	PISTON + RINGS Kolben + Ringe Piston + Segments Pistón Set Поршень и кольца			PISTON SET Kolben Set Set de Piston Pistón Set поршневой	RINGS SET Kolben Set Segments de Piston Anillos Set кольца	PIN Pin Axe Perno Пин
<b>M111</b> 4 Cyl 89.9 mm Bore Ø 1,998 cc		Length: Outside Ø: Flange Ø: flange depth	STD	0.25	0.50	skirt MOS2 treated	Top: 1.5 2nd: 1.75 3rd: 3.0 1st oil: 2nd oil:	Ø: 22.0 Length: 56.0
			55.15	54.85	54.85			
			Comp: 31.65	31.35	31.35			
		Height: -2.35	-2.75	-2.90				
		Reference no.:	Reference no.:	Reference no.:	Reference no.:	O-RING		
			<b>K-92241601</b> <b>M-0030700</b>	<b>111 030 54 17</b>		<b>112 030 01 24</b> <b>112 030 03 24</b> <b>G-0828750000</b> <b>K-800017921000</b> <b>M-00140N0</b>		
NM-Germany Article no. Artikelnummer/ Modelo Número / статья НОМЕР	NM-Germany Article no.	NM-Germany Article no.	NM-Germany Article no.	NM-Germany Article no.	NM-Germany Article no.	NM-Germany Article no.	NM-Germany Article no.	
			<b>KBSMB40463G</b>	<b>KBMB40463G</b>	<b>KRMB40463G</b>			



ENGINE TYPE Motortyp Type de Moteur Tipo de motor Тип двигателя	LINER KIT Liner Kit Kit de Chemise Camisas de los cilindros лайнер комплект	CYL. LINER Zylinderlaufbuchse Chemise Camisas de los cilindros втулка цилиндра	PISTON + RINGS Kolben + Ringe Piston + Segments Pistón Set Поршень и кольца			PISTON SET Kolben Set Set de Piston Pistón Set поршневой	RINGS SET Kolben Set Segments de Piston Anillos Set кольца	PIN Pin Axe Perno Пин
<b>M111</b> 4 Cyl 89.9 mm Bore Ø 1,998 cc		Length: Outside Ø: Flange Ø: flange depth	STD	0.25	0.50	skirt MOS2 treated	Top: 1.5 2nd: 1.75 3rd: 3.0 1st oil: 2nd oil:	Ø: 22.0 Length: 56.0
			59.5	58.6	58.5			
			Comp: 30.0	30.0	30.0			
		Height: +6.0	+5.1	+5.0				
		Reference no.:	Reference no.:	Reference no.:	Reference no.:	O-RING		
			<b>K-94549601</b> <b>M-0052100</b>	<b>111 030 43 18</b>		<b>112 030 01 24</b> <b>112 030 03 24</b> <b>G-0828750000</b> <b>K-800017921000</b> <b>M-00140N0</b>		
NM-Germany Article no. Artikelnummer/ Modelo Número / статья НОМЕР	NM-Germany Article no.	NM-Germany Article no.	NM-Germany Article no.	NM-Germany Article no.	NM-Germany Article no.	NM-Germany Article no.	NM-Germany Article no.	
			<b>KBSMB40464G</b>	<b>KBMB40464G</b>	<b>KRMB40464G</b>			

MERCEDES

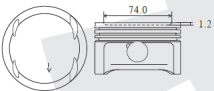

**GASOLINE**

ENGINE TYPE	LINER KIT	CYL. LINER	PISTON + RINGS		PISTON SET	RINGS SET	PIN
Motor typ Type de Moteur Tipo de motor Тип двигателя	Liner Kit Kit de Chemise Camisas de los cilindros лайнер комплект	Zylinderlaufbuchse Chemise Camisas de los cilindros втулка цилиндра		STD O/S	Kolben Set Set de Piston Pistón Set поршневой	Kolben Set Segments de Piston Anillos Set кольца	Pin Axe Perno Пин
<b>M104</b> 6 Cyl 89.9 mm Bore Ø 2,799 cc		Length: 133.0 Outside Ø: 92.5 Flange Ø: 94.0 flange depth 4.7	Length: 57.1 Comp: 32.4 Height: +1.2	57.1 32.1 56.0		Top: 1.5 2nd: 1.75 3rd: 3.0 1st oil: 2nd oil:	Ø: 1.2 Length: 22.0
		Reference no.:	Reference no.:	Reference no.:	Reference no.:	O-RING	
		<b>K-89509190</b>	<b>K-94420600</b> <b>M-0014100</b>	<b>104 030 04 18</b> <b>104 030 07 18</b> <b>104 030 08 18</b> <b>104 030 39 17</b> <b>104 030 44 17</b> <b>104 030 74 17</b> <b>104 030 77 17</b> <b>104 030 78 17</b> <b>104 030 86 17</b> <b>104 037 43 01</b> <b>104 037 77 01</b>	<b>112 030 01 24</b> <b>112 030 03 24</b> <b>G-0828750000</b> <b>K-800017921000</b> <b>M-00140N0</b>		
NM-Germany Article no. Artikelnummer/ Modelo Número / статья НОМЕР	NM-Germany Article no.	NM-Germany Article no.	NM-Germany Article no.	NM-Germany Article no.	NM-Germany Article no.	NM-Germany Article no.	NM-Germany Article no.
	<b>LBSMB60465GS</b>	<b>LBMB60465GS</b>	<b>KBSMB60465G</b>	<b>KBMB60465G</b>	<b>KRMB60465G</b>		

**GASOLINE**

ENGINE TYPE	LINER KIT	CYL. LINER	PISTON + RINGS		PISTON SET	RINGS SET	PIN
Motor typ Type de Moteur Tipo de motor Тип двигателя	Liner Kit Kit de Chemise Camisas de los cilindros лайнер комплект	Zylinderlaufbuchse Chemise Camisas de los cilindros втулка цилиндра		STD O/S	Kolben Set Set de Piston Pistón Set поршневой	Kolben Set Segments de Piston Anillos Set кольца	Pin Axe Perno Пин
<b>M104</b> 6 Cyl 89.9 mm Bore Ø 3,199 cc		Length: 133.0 Outside Ø: 92.5 Flange Ø: 94.0 flange depth 4.7	Length: 54.6 Comp: 31.1 Height: -1.2	54.6 30.8 -1.2		Top: 1.5 2nd: 1.75 3rd: 3.0 1st oil: 2nd oil:	Ø: 22.0 Length: 56.0
		Reference no.:	Reference no.:	Reference no.:	Reference no.:	O-RING	
		<b>K-89509190</b>	<b>K-94301600</b> <b>M-0014000</b>	<b>104 030 12 18</b> <b>104 030 29 17</b> <b>104 030 33 17</b> <b>104 030 48 17</b> <b>104 030 58 17</b> <b>104 030 66 17</b> <b>104 030 70 17</b> <b>104 030 82 17</b> <b>104 030 91 17</b> <b>104 037 47 01</b>	<b>112 030 01 24</b> <b>112 030 03 24</b> <b>G-0828750000</b> <b>K-800017921000</b> <b>M-00140N0</b>		
NM-Germany Article no. Artikelnummer/ Modelo Número / статья НОМЕР	NM-Germany Article no.	NM-Germany Article no.	NM-Germany Article no.	NM-Germany Article no.	NM-Germany Article no.	NM-Germany Article no.	NM-Germany Article no.
	<b>LBSMB60466GS</b>	<b>LBMB60466GS</b>	<b>KBSMB60466G</b>	<b>KBMB60466G</b>	<b>KRMB60466G</b>		

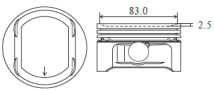
**GASOLINE**

ENGINE TYPE	LINER KIT	CYL. LINER	PISTON + RINGS		PISTON SET	RINGS SET	PIN
Motor typ Type de Moteur Tipo de motor Тип двигателя	Liner Kit Kit de Chemise Camisas de los cilindros лайнер комплект	Zylinderlaufbuchse Chemise Camisas de los cilindros втулка цилиндра			Kolben Set Set de Piston Pistón Set поршневой	Kolben Set Segments de Piston Anillos Set кольца	Pin Axe Perno Пин
<b>M112 E32</b> <b>M113 E43</b> 6/8 Cyl 89.9 mm Bore Ø 3,199 cc 4,266 cc		Length: 133.0 Outside Ø: 92.5 Flange Ø: 94.0 flange depth 4.7	Length: 53.3 Comp: 31.3 Height: -2.5		head, top and 2nd ring lands anodized skirt MOS2 treated	Top: 1.5 2nd: 1.75 3rd: 3.0 1st oil: 2nd oil:	Ø: 22.0 Length: 52.0
		Reference no.:	Reference no.:	Reference no.:	Reference no.:	O-RING	
		<b>K-89509190</b>	<b>M-0011400</b>	<b>112 030 06 17</b> <b>112 030 41 17</b>	<b>112 030 01 24</b> <b>112 030 03 24</b> <b>G-0828750000</b> <b>K-800017921000</b> <b>M-00140N0</b>		
NM-Germany Article no. Artikelnummer/ Modelo Número / статья НОМЕР	NM-Germany Article no.	NM-Germany Article no.	NM-Germany Article no.	NM-Germany Article no.	NM-Germany Article no.	NM-Germany Article no.	NM-Germany Article no.
	<b>LBSMB680467GS</b>	<b>LBMB680467GS</b>	<b>KBSMB680467G</b>	<b>KBMB680467G</b>	<b>KRMB680467G</b>		

**DIESEL**

ENGINE TYPE	LINER KIT	CYL. LINER	PISTON + RINGS			PISTON SET	RINGS SET	PIN	
Motortyp Type de Moteur Tipo de motor Тип двигателя	Liner Kit Kit de Chemise Camisas de los cilindros лайнер комплект	Zylinderlaufbuchse Chemise Camisas de los cilindros втулка цилиндра	Kolben + Ringe Piston + Segments Pistón Set Поршень и кольца			Kolben Set Set de Piston Pistón Set поршневой	Kolben Set Segments de Piston Anillos Set кольца	Pin Axe Perno Пин	
<b>OM 616</b> <b>OM 617</b> 4/5 Cyl 90.9 mm Bore Ø 2,399 cc 2,998 cc	(A) <b>K-93444960</b> <b>M-0024990</b> consists of (C)  (B) <b>K-93444969</b> <b>M-0024991</b> consists of (D)	(C)	(D)			alfin skirt MOS2 treated	Top: 3.0 2nd: 2.0 3rd: 4.0 1st oil: 2nd oil: 4.0	Ø: 26.0  Length: 74.0	
		Length:	158.4	158.4	Length:				81.9
		Outside Ø:	94.0	94.6	Comp:				48.4
		Flange Ø:	96.0	96.5	Height:				-1.2
		flange depth	4.7	4.8					
		Reference no.:	Reference no.:		Reference no.:	Reference no.:	O-RING		
		(C)	(D)						
		616 011 03 10 616 011 05~12 10 A-SU351119 G-1402135000 K-88681160 K-88681190 M-001WV04	K-93444600 M-0024900 N-8717670000		616 030 39 17 616 030 60 17 616 030 64 17 616 030 66 17 616 030 69 17	616 030 00 24 A-R41220 G-0817670010 K-800018410000 M-00249N0			
		(D) M-001WV19							
NM-Germany Article no. Artikelnummer/ Modelo Número / статья НОМЕР	NM-Germany Article no.	NM-Germany Article no.	NM-Germany Article no.		NM-Germany Article no.	NM-Germany Article no.	NM-Germany Article no.	NM-Germany Article no.	
	(A) LBSMB4504681DSA (B) LBSMB4504681DSA	(C) LBMB4504681DS (D) LBMB4504681DS	KBSMB450468DA		KBMB450468DA	KRMB450468D			

ENGINE TYPE	LINER KIT	CYL. LINER	PISTON + RINGS			PISTON SET	RINGS SET	PIN	
Motortyp Type de Moteur Tipo de motor Тип двигателя	Liner Kit Kit de Chemise Camisas de los cilindros лайнер комплект	Zylinderlaufbuchse Chemise Camisas de los cilindros втулка цилиндра	Kolben + Ringe Piston + Segments Pistón Set Поршень и кольца			Kolben Set Set de Piston Pistón Set поршневой	Kolben Set Segments de Piston Anillos Set кольца	Pin Axe Perno Пин	
<b>OM 616</b> <b>OM 617</b> 4/5 Cyl 90.9 mm Bore Ø 2,399 cc 2,998 cc	(A) <b>K-92800961</b> <b>M-0024490</b> consists of (C)  (B) <b>M-0024491</b> consists of (D)	(C)	(D)			alfin skirt MOS2 treated	Top: 3.0 2nd: 2.0 3rd: 4.0 1st oil: 2nd oil: 4.0	Ø: 26.0  Length: 74.0	
		Length:	158.4	158.4	Length:				81.85
		Outside Ø:	94.0	94.6	Comp:				48.35
		Flange Ø:	96.0	96.5	Height:				-1.05
		flange depth	4.7	4.8					
		Reference no.:	Reference no.:		Reference no.:	Reference no.:	O-RING		
		(C)	(D)						
		616 011 03 10 616 011 05~12 10 A-SU351119 G-1402135000 K-88681160 K-88681190 M-001WV04	K-92800630 M-0024400		602 030 63 17 616 030 35 17 616 030 44 17 616 030 49 17 616 030 59 17 616 030 62 17 616 030 63 17 616 030 67 17 616 030 70 17 617 030 44 17	616 030 00 24 A-R41220 G-0817670010 K-800018410000 M-00249N0			
		(D) M-001WV19							
NM-Germany Article no. Artikelnummer/ Modelo Número / статья НОМЕР	NM-Germany Article no.	NM-Germany Article no.	NM-Germany Article no.		NM-Germany Article no.	NM-Germany Article no.	NM-Germany Article no.	NM-Germany Article no.	
	(A) LBSMB4504691DSA (B) LBSMB4504691DSA	(C) LBMB4504691DS (D) LBMB4504691DS	KBSMB450469DA		KBMB450469DA	KRMB450469D			

MERCEDES







**GASOLINE**

ENGINE TYPE Motortyp Type de Moteur Tipo de motor Тип двигателя	LINER KIT Liner Kit Kit de Chemise Camisas de los cilindros лайнер комплект	CYL. LINER Zylinderlaufbuchse Chemise Camisas de los cilindros втулка цилиндра	PISTON + RINGS Kolben + Ringe Piston + Segments Pistón Set Поршень и кольца		PISTON SET Kolben Set Set de Piston Pistón Set поршневой	RINGS SET Kolben Set Segments de Piston Anillos Set кольца	PIN Pin Axe Perno Пин
<b>M115</b> 4 Cyl 93.75 mm Bore Ø 2,307 cc		Length: 82.0 Outside Ø: 81.4 Flange Ø: 51.8 flange depth: 51.2	STD	O/S		Top: 1.75 2nd: 2.5 3rd: 4.0 1st oil: 2nd oil:	Ø: 26.0 Length: 73.0
			Length: 82.0	81.4			
			Comp: 51.8	51.2			
			Height: -1.1	-1.1			
			Reference no.:	Reference no.:	Reference no.:	Reference no.:	O-RING
				<b>K-92931600</b> <b>M-0026000</b>	<b>115 030 03 19</b> <b>115 030 35 18</b> <b>115 030 49 18</b> <b>115 030 52 18</b> <b>115 030 91 18</b> <b>115 030 99 18</b>	<b>K-800018741000</b> <b>M-00260V0</b>	
NM-Germany Article no. Artikelnummer/ Modelo Número / статья НОМЕР	NM-Germany Article no.	NM-Germany Article no.	NM-Germany Article no.	NM-Germany Article no.	NM-Germany Article no.	NM-Germany Article no.	NM-Germany Article no.
			<b>KBSMB40473G</b>	<b>KBMB40473G</b>	<b>KRMB40473G</b>		

**GASOLINE**

ENGINE TYPE Motortyp Type de Moteur Tipo de motor Тип двигателя	LINER KIT Liner Kit Kit de Chemise Camisas de los cilindros лайнер комплект	CYL. LINER Zylinderlaufbuchse Chemise Camisas de los cilindros втулка цилиндра	PISTON + RINGS Kolben + Ringe Piston + Segments Pistón Set Поршень и кольца		PISTON SET Kolben Set Set de Piston Pistón Set поршневой	RINGS SET Kolben Set Segments de Piston Anillos Set кольца	PIN Pin Axe Perno Пин
<b>M102</b> 4 Cyl 95.5 mm Bore Ø 2,299 cc		Length: 147.0 Outside Ø: 98.5 Flange Ø: 100.3 flange depth: 4.7	STD	O/S		Top: 1.75 2nd: 2.0 3rd: 3.5 1st oil: 2nd oil:	Ø: 22.0 Length: 56.0
			Length: 76.2	75.9			
			Comp: 43.3	43.0			
			Height: -1.9	-1.9			
			Reference no.:	Reference no.:	Reference no.:	Reference no.:	O-RING
			<b>K-89508190</b>	<b>K-93968600</b> <b>M-0026910</b> <b>N-8717970010</b>	<b>102 030 02 37</b> <b>102 030 09 19</b> <b>102 030 13 19</b> <b>102 030 60 18</b> <b>102 030 70 37</b> <b>102 030 87 19</b> <b>102 030 91 19</b> <b>102 030 94 37</b> <b>102 030 97 37</b> <b>102 030 98 19</b> <b>102 037 28 03</b> <b>102 037 29 03</b>	<b>G-0817970000</b> <b>K-800018940000</b> <b>M-00277N0</b>	
NM-Germany Article no. Artikelnummer/ Modelo Número / статья НОМЕР	NM-Germany Article no.	NM-Germany Article no.	NM-Germany Article no.	NM-Germany Article no.	NM-Germany Article no.	NM-Germany Article no.	NM-Germany Article no.
	<b>LBSMB40474GS</b>	<b>LBMB40474GS</b>	<b>KBSMB40474G</b>	<b>KBMB40474G</b>	<b>KRMB40474G</b>		

**GASOLINE**

ENGINE TYPE Motortyp Type de Moteur Tipo de motor Тип двигателя	LINER KIT Liner Kit Kit de Chemise Camisas de los cilindros лайнер комплект	CYL. LINER Zylinderlaufbuchse Chemise Camisas de los cilindros втулка цилиндра	PISTON + RINGS Kolben + Ringe Piston + Segments Pistón Set Поршень и кольца		PISTON SET Kolben Set Set de Piston Pistón Set поршневой	RINGS SET Kolben Set Segments de Piston Anillos Set кольца	PIN Pin Axe Perno Пин
<b>M102</b> 4 Cyl 95.5 mm Bore Ø 2,299 cc		Length: 147.0 Outside Ø: 98.5 Flange Ø: 100.3 flange depth: 4.7	STD	O/S		Top: 1.75 2nd: 2.0 3rd: 3.5 1st oil: 2nd oil:	Ø: 24.0 Length: 62.0
			Length: 83.2	82.9			
			Comp: 43.2	42.9			
			Height: -1.9	-1.9			
			Reference no.:	Reference no.:	Reference no.:	Reference no.:	O-RING
			<b>K-89508190</b>	<b>K-93495600</b> <b>M-0027000</b> <b>N-8717970000</b>	<b>102 030 16 18</b> <b>102 030 20 18</b> <b>102 030 36 17</b> <b>102 030 40 17</b> <b>102 030 44 17</b> <b>102 030 46 17</b> <b>102 030 68 17</b>	<b>G-0817970000</b> <b>K-800018940000</b> <b>M-00277N0</b>	
NM-Germany Article no. Artikelnummer/ Modelo Número / статья НОМЕР	NM-Germany Article no.	NM-Germany Article no.	NM-Germany Article no.	NM-Germany Article no.	NM-Germany Article no.	NM-Germany Article no.	NM-Germany Article no.
	<b>LBSMB40475GS</b>	<b>LBMB40475GS</b>	<b>KBSMB40475G</b>	<b>KBMB40475G</b>	<b>KRMB40475G</b>		



**DIESEL**

ENGINE TYPE	LINER KIT	CYL. LINER	PISTON + RINGS			PISTON SET	RINGS SET	PIN																																				
Motortyp Type de Moteur Tipo de motor Тип двигателя	Liner Kit Kit de Chemise Camisas de los cilindros лайнер комплект	Zylinderlaufbuchse Chemise Camisas de los cilindros втулка цилиндра	Kolben + Ringe Piston + Segments Pistón Set Поршень и кольца			Kolben Set Set de Piston Pistón Set поршень	RINGS SET Kolben Set Segments de Piston Anillos Set кольца	PIN Pin Axe Perno Пин																																				
<b>OM 314/340</b> <b>OM 343/394</b> <b>OM 341/344</b> <b>OM 352/353</b> <b>OM 396</b>	(A) <b>K-90274982</b> <b>M-0044584</b> consists of (C)  (B) <b>K-90274980</b> <b>M-0044583</b> consists of (D)	<table border="1"> <tr> <td></td> <td>(C)</td> <td>(D)</td> <td></td> <td></td> <td></td> <td></td> </tr> <tr> <td>Length:</td> <td>222.0</td> <td>222.0</td> <td>Length:</td> <td>STD</td> <td>0.50</td> <td>1.00</td> </tr> <tr> <td>Outside Ø:</td> <td>100.4</td> <td>101.0</td> <td>Comp:</td> <td>65.2</td> <td>64.8</td> <td>64.6</td> </tr> <tr> <td>Flange Ø:</td> <td>103.5</td> <td>104.0</td> <td>Height:</td> <td>-20.0</td> <td>-20.0</td> <td>-20.0</td> </tr> <tr> <td></td> <td>5.2</td> <td>5.2</td> <td></td> <td></td> <td></td> <td></td> </tr> </table>		(C)	(D)					Length:	222.0	222.0	Length:	STD	0.50	1.00	Outside Ø:	100.4	101.0	Comp:	65.2	64.8	64.6	Flange Ø:	103.5	104.0	Height:	-20.0	-20.0	-20.0		5.2	5.2										Top: 3.0 double keystone 2nd: 3.0 3rd: 3.0 1st oil: 5.5 2nd oil: 5.5	Ø: 36.0  Length: 82.5
	(C)	(D)																																										
Length:	222.0	222.0	Length:	STD	0.50	1.00																																						
Outside Ø:	100.4	101.0	Comp:	65.2	64.8	64.6																																						
Flange Ø:	103.5	104.0	Height:	-20.0	-20.0	-20.0																																						
	5.2	5.2																																										
4/6 Cyl  97.0 Bore Ø  3,780 cc 5,675 cc		Reference no.: (C) <b>352 011 16 10</b> <b>A-SU351281</b> <b>G-1402580000</b> <b>K-89177190</b> <b>M-004WV09</b>  (D) <b>352 011 18 10</b> <b>G-1402580100</b> <b>K-89178190</b> <b>M-004WV08</b>	Reference no.: <b>K-90274800</b> <b>M-0044510</b> <b>N-8717430000</b>	Reference no.: <b>352 030 14 19</b> <b>352 030 15 18</b> <b>352 030 15 19</b> <b>352 030 16 19</b> <b>352 030 17 19</b> <b>352 030 18 18</b> <b>352 030 18 19</b> <b>352 030 19 18</b> <b>352 030 19 19</b> <b>352 030 25 17</b> <b>352 030 25 18/19</b> <b>352 030 26/27 19</b>	Reference no.: <b>G-0817430010</b> <b>K-800010910000</b> <b>M-00445N0</b>	Reference no.: O-RING																																						
NM-Germany Article no. Artikelnummer/ Modelo Número / статья НОМЕР	NM-Germany Article no.	NM-Germany Article no.	NM-Germany Article no.	NM-Germany Article no.	NM-Germany Article no.	NM-Germany Article no.	NM-Germany Article no.																																					
	(A) <b>LBSMB4604761DSA</b>  (B) <b>LBSMB4604761DSA</b>	(C) <b>LBMB4604761DA</b>  (D) <b>LBMB4604762DA</b>	<b>KBSMB460476DA</b>	<b>KBMB460476DA</b>	<b>KRMB460476D</b>																																							

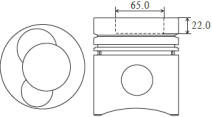

**DIESEL**

ENGINE TYPE	LINER KIT	CYL. LINER	PISTON + RINGS			PISTON SET	RINGS SET	PIN																																			
Motortyp Type de Moteur Tipo de motor Тип двигателя	Liner Kit Kit de Chemise Camisas de los cilindros лайнер комплект	Zylinderlaufbuchse Chemise Camisas de los cilindros втулка цилиндра	Kolben + Ringe Piston + Segments Pistón Set Поршень и кольца			Kolben Set Set de Piston Pistón Set поршень	RINGS SET Kolben Set Segments de Piston Anillos Set кольца	PIN Pin Axe Perno Пин																																			
<b>OM 314/340/343</b> <b>OM 344/352/353</b> <b>OM 394/396</b> also for TOYOTA	(A) <b>K-93882962</b> <b>M-0045194</b> consists of (C)  (B) <b>K-93882960</b> <b>M-0045193</b> consists of (D)	<table border="1"> <tr> <td></td> <td>(C)</td> <td>(D)</td> <td></td> <td></td> <td></td> <td></td> </tr> <tr> <td>Length:</td> <td>222.0</td> <td>222.0</td> <td>Length:</td> <td>STD</td> <td>0.50</td> <td>1.00</td> </tr> <tr> <td>Outside Ø:</td> <td>100.4</td> <td>101.0</td> <td>Comp:</td> <td>65.2</td> <td>64.9</td> <td>64.6</td> </tr> <tr> <td>Flange Ø:</td> <td>103.5</td> <td>104.0</td> <td>Height:</td> <td>-20.0</td> <td>-20.0</td> <td>-20.0</td> </tr> <tr> <td>flange depth</td> <td>5.2</td> <td>5.2</td> <td></td> <td></td> <td></td> <td></td> </tr> </table>		(C)	(D)					Length:	222.0	222.0	Length:	STD	0.50	1.00	Outside Ø:	100.4	101.0	Comp:	65.2	64.9	64.6	Flange Ø:	103.5	104.0	Height:	-20.0	-20.0	-20.0	flange depth	5.2	5.2									Top: 3.0 double keystone 2nd: 3.0 3rd: 3.0 1st oil: 5.5 2nd oil: 5.5	Ø: 36.0  Length: 82.5
	(C)	(D)																																									
Length:	222.0	222.0	Length:	STD	0.50	1.00																																					
Outside Ø:	100.4	101.0	Comp:	65.2	64.9	64.6																																					
Flange Ø:	103.5	104.0	Height:	-20.0	-20.0	-20.0																																					
flange depth	5.2	5.2																																									
4/6 Cyl  97.0 mm Bore Ø  3,780 cc 5,675 cc		Reference no.: (C) <b>352 011 16 10</b> <b>A-SU351281</b> <b>G-1402580000</b> <b>K-89177190</b> <b>M-004WV09</b>  (D) <b>352 011 18 10</b> <b>G-1402580100</b> <b>K-89178190</b> <b>M-004WV08</b>	Reference no.: <b>K-93882600</b> <b>M-0045100</b> <b>N-8717880000</b>	Reference no.: alfin skirt MOS2 treated	Reference no.: <b>A-R45970</b> <b>G-0817880000</b> <b>K-800010810000</b> <b>M-00451N0</b>	Reference no.: O-RING																																					
NM-Germany Article no. Artikelnummer/ Modelo Número / статья НОМЕР	NM-Germany Article no.	NM-Germany Article no.	NM-Germany Article no.	NM-Germany Article no.	NM-Germany Article no.	NM-Germany Article no.	NM-Germany Article no.																																				
	(A) <b>LBSMB4604771DSA</b> (B) <b>LBSMB4604771DSA</b>	(C) <b>LBMB4604771DS</b> (D) <b>LBMB4604772DS</b>	<b>KBSMB460477DA</b>	<b>KBMB460477DA</b>	<b>KRMB460477D</b>																																						

**DIESEL**

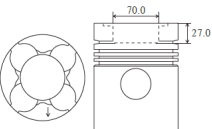

ENGINE TYPE Motortyp Type de Moteur Tipo de motor Тип двигателя	LINER KIT Liner Kit Kit de Chemise Camisas de los cilindros лайнер комплект	CYL. LINER Zylinderlaufbuchse Chemise Camisas de los cilindros втулка цилиндра	PISTON + RINGS Kolben + Ringe Piston + Segments Pistón Set Поршень и кольца		PISTON SET Kolben Set Set de Piston Pistón Set поршневой	RINGS SET Kolben Set Segments de Piston Anillos Set кольца	PIN Pin Axe Perno Пин
<b>OM 360</b> 6 Cyl 115.0 mm Bore Ø 8,725 cc 	<b>K-93508960</b> <b>M-0051190</b>	Length: 253.5 Outside Ø: 120.0 Flange Ø: 125.0 flange depth 5.5	Length: 133.4 Comp: 85.4 Height: -22.0		alfin skirt MOS2 treated	Top: 3.5 double keystone 2nd: 3.0 3rd: 1st oil: 5.5 2nd oil:	Ø: 42.0 Length: 98.0
		<b>Reference no.:</b>		<b>Reference no.:</b>	<b>Reference no.:</b>	<b>Reference no.:</b>	<b>O-RING</b>
		<b>G-1402424000</b> <b>K-89043190</b> <b>M-005WV03</b>		<b>K-93508600</b> <b>M-0051100</b> <b>N-8717640000</b>		<b>G-0817640010</b> <b>K-800011010000</b> <b>M-00511N0</b>	
NM-Germany Article no. Artikelnummer/ Modelo Número / статья НОМЕР	NM-Germany Article no.	NM-Germany Article no.	NM-Germany Article no.	NM-Germany Article no.	NM-Germany Article no.	NM-Germany Article no.	NM-Germany Article no.
	<b>LBSMB60478DSA</b>	<b>LBMB60478DSA</b>	<b>KBSMB60478DA</b>	<b>KBMB60478DA</b>	<b>KRMB60478DA</b>		

**DIESEL**

ENGINE TYPE Motortyp Type de Moteur Tipo de motor Тип двигателя	LINER KIT Liner Kit Kit de Chemise Camisas de los cilindros лайнер комплект	CYL. LINER Zylinderlaufbuchse Chemise Camisas de los cilindros втулка цилиндра	PISTON + RINGS Kolben + Ringe Piston + Segments Pistón Set Поршень и кольца		PISTON SET Kolben Set Set de Piston Pistón Set поршневой	RINGS SET Kolben Set Segments de Piston Anillos Set кольца	PIN Pin Axe Perno Пин
<b>OM 335/345</b> <b>OM 347/355</b> 5/6 Cyl 128.0 mm Bore Ø 9,651 cc 11,581 cc 	<b>K-93568960</b> <b>M-0035490</b>	Length: 287.5 Outside Ø: 133.5 Flange Ø: 137.5 flange depth 5.5	Length: 161.26 161.06 Comp: 90.26 90.06 Height: -27.0 -26.8	STD O/S	alfin skirt MOS2 treated	Top: 3.5 double keystone 2nd: 3.5 3rd: 3.5 1st oil: 6.5 2nd oil:	Ø: 48.0 Length: 108.0
		<b>Reference no.:</b>		<b>Reference no.:</b>	<b>Reference no.:</b>	<b>Reference no.:</b>	<b>O-RING</b>
		<b>G-1402589000</b> <b>K-88869190</b> <b>M-003WV09</b>		<b>K-93568600</b> <b>M-0035400</b> <b>N-8717690000</b>	<b>G-8717690000</b>	<b>A-R46000</b> <b>G-0817690010</b> <b>K-800019611000</b> <b>M-00354V0</b>	
NM-Germany Article no. Artikelnummer/ Modelo Número / статья НОМЕР	NM-Germany Article no.	NM-Germany Article no.	NM-Germany Article no.	NM-Germany Article no.	NM-Germany Article no.	NM-Germany Article no.	NM-Germany Article no.
	<b>LBSMB560479DSA</b>	<b>LBMB560479DSA</b>	<b>KBSMB560479DA</b>	<b>KBMB560479DA</b>	<b>KRMB560479DA</b>		

MERCEDES

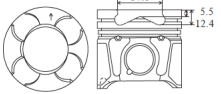

**DIESEL**

ENGINE TYPE Motortyp Type de Moteur Tipo de motor Тип двигателя	LINER KIT Liner Kit Kit de Chemise Camisas de los cilindros лайнер комплект	CYL. LINER Zylinderlaufbuchse Chemise Camisas de los cilindros втулка цилиндра	PISTON + RINGS Kolben + Ringe Piston + Segments Pistón Set Поршень и кольца			PISTON SET Kolben Set Set de Piston Pistón Set поршневой	RINGS SET Kolben Set Segments de Piston Anillos Set кольца	PIN Pin Axe Perno Пин		
<b>Y 13 DT</b> <b>Z 13 DT</b> 4 Cyl 69.6 mm Bore Ø 1,248 cc 		Length: Outside Ø: Flange Ø: flange depth	Length: 63.43 Comp: 40.43 Height: -5.5 -12.4		alfin skirt MOS2 treated fits tapered con. rod	Top: 2.0 2nd: 1.5 3rd: 1st oil: 2.0 2nd oil:	Ø: 23.0 Length: 56.5			
						Reference no.:	Reference no.:	Reference no.:	Reference no.:	O-RING
							<b>A-A354085</b> <b>K-40213600</b> <b>M-0100400</b> <b>N-8713760000</b>		<b>A-R66830</b> <b>G-0813760000</b> <b>K-800056240000</b> <b>M-01004N0</b>	
NM-Germany Article no. Artikelnummer/ Modelo Número / статья НОМЕР	NM-Germany Article no.	NM-Germany Article no.	NM-Germany Article no.	NM-Germany Article no.	NM-Germany Article no.	NM-Germany Article no.	NM-Germany Article no.			
			KBSOP40489DA	KBOP40489DA	KROP40489DA					

**DIESEL**

ENGINE TYPE Motortyp Type de Moteur Tipo de motor Тип двигателя	LINER KIT Liner Kit Kit de Chemise Camisas de los cilindros лайнер комплект	CYL. LINER Zylinderlaufbuchse Chemise Camisas de los cilindros втулка цилиндра	PISTON + RINGS Kolben + Ringe Piston + Segments Pistón Set Поршень и кольца			PISTON SET Kolben Set Set de Piston Pistón Set поршневой	RINGS SET Kolben Set Segments de Piston Anillos Set кольца	PIN Pin Axe Perno Пин		
<b>Z 13 DTJ</b> 4 Cyl 69.6 mm Bore Ø 1,248 cc		Length: Outside Ø: Flange Ø: flange depth	Length: Comp: Height:		alfin skirt MOS2 treated	Top: 2nd: 3rd: 1st oil: 2nd oil:	Ø: Length:			
						Reference no.:	Reference no.:	Reference no.:	Reference no.:	O-RING
NM-Germany Article no. Artikelnummer/ Modelo Número / статья НОМЕР	NM-Germany Article no.	NM-Germany Article no.	NM-Germany Article no.	NM-Germany Article no.	NM-Germany Article no.	NM-Germany Article no.	NM-Germany Article no.			
			KBSOP40490DA	KBOP40490DA	KROP40490DA					

**DIESEL**

ENGINE TYPE Motortyp Type de Moteur Tipo de motor Тип двигателя	LINER KIT Liner Kit Kit de Chemise Camisas de los cilindros лайнер комплект	CYL. LINER Zylinderlaufbuchse Chemise Camisas de los cilindros втулка цилиндра	PISTON + RINGS Kolben + Ringe Piston + Segments Pistón Set Поршень и кольца			PISTON SET Kolben Set Set de Piston Pistón Set поршневой	RINGS SET Kolben Set Segments de Piston Anillos Set кольца	PIN Pin Axe Perno Пин		
<b>Z 13 DTH Euro 4</b> 4 Cyl 69.6 mm Bore Ø 1,248 cc 		Length: Outside Ø: Flange Ø: flange depth	Length: 62.5 Comp: 40.5 Height: -6.0 -12.3		alfin and with oil gallery skirt MOS2 treated fits tapered con. rod	Top: 2.0 2nd: 1.5 3rd: 1st oil: 2.0 2nd oil:	Ø: 23.0 Length: 57.0			
						Reference no.:	Reference no.:	Reference no.:	Reference no.:	O-RING
							<b>K-40659600</b> <b>N-8742560000</b>		<b>A-R66830</b> <b>G-0813760000</b> <b>K-800056240000</b> <b>M-01004N0</b>	
NM-Germany Article no. Artikelnummer/ Modelo Número / статья НОМЕР	NM-Germany Article no.	NM-Germany Article no.	NM-Germany Article no.	NM-Germany Article no.	NM-Germany Article no.	NM-Germany Article no.	NM-Germany Article no.			
			KBSOP40491DB	KBOP40491DB	KROP40491DB					

**GASOLINE**

ENGINE TYPE Motortyp Type de Moteur Tipo de motor Тип двигателя	LINER KIT Liner Kit Kit de Chemise Camisas de los cilindros лайнер комплект	CYL. LINER Zylinderlaufbuchse Chemise Camisas de los cilindros втулка цилиндра	PISTON + RINGS Kolben + Ringe Piston + Segments Pistón Set Поршень и кольца			PISTON SET Kolben Set Set de Piston Pistón Set поршневой	RINGS SET Kolben Set Segments de Piston Anillos Set кольца	PIN Pin Axe Perno Пин
<b>GM 1.0L MPFI</b> 4 Cyl 71.1 mm Bore Ø 999 cc		Length: Outside Ø: Flange Ø: flange depth	Length:	59.1	Reference no.:	Top:	1.5	Ø: 18.0 Length: 50.0
			Comp:	38.0		2nd:	1.5	
			Height:	0		3rd:	3.0	
			Reference no.:	Reference no.:	Reference no.:	Reference no.:	O-RING	
			<b>M-S14080</b>	<b>M-E14080</b>	<b>M-A14140</b>			
NM-Germany Article no. Artikelnummer/ Modelo Número / статья НОМЕР	NM-Germany Article no.	NM-Germany Article no.	NM-Germany Article no.	NM-Germany Article no.	NM-Germany Article no.	NM-Germany Article no.	NM-Germany Article no.	
			<b>KBSOP40492G</b>	<b>KBOP40492G</b>	<b>KROP40492G</b>			

OPEL



**GASOLINE**

ENGINE TYPE Motortyp Type de Moteur Tipo de motor Тип двигателя	LINER KIT Liner Kit Kit de Chemise Camisas de los cilindros лайнер комплект	CYL. LINER Zylinderlaufbuchse Chemise Camisas de los cilindros втулка цилиндра	PISTON + RINGS Kolben + Ringe Piston + Segments Pistón Set Поршень и кольца			PISTON SET Kolben Set Set de Piston Pistón Set поршневой	RINGS SET Kolben Set Segments de Piston Anillos Set кольца	PIN Pin Axe Perno Пин
<b>GM 1.0L MPFI</b> 4 Cyl 71.1 mm Bore Ø 999 cc		Length: Outside Ø: Flange Ø: flange depth	Length:	58.3	Reference no.:	Top:	1.5	Ø: 18.0 Length: 50.0
			Comp:	37.3		2nd:	1.5	
			Height:	-1.98		3rd:	3.0	
			Reference no.:	Reference no.:	Reference no.:	Reference no.:	O-RING	
			<b>M-S14145</b>	<b>M-E14145</b>	<b>M-A14140</b>			
NM-Germany Article no. Artikelnummer/ Modelo Número / статья НОМЕР	NM-Germany Article no.	NM-Germany Article no.	NM-Germany Article no.	NM-Germany Article no.	NM-Germany Article no.	NM-Germany Article no.	NM-Germany Article no.	
			<b>KBSOP40493G</b>	<b>KBOP40493G</b>	<b>KROP40493G</b>			

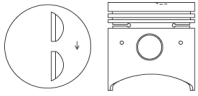

**GASOLINE**

ENGINE TYPE Motortyp Type de Moteur Tipo de motor Тип двигателя	LINER KIT Liner Kit Kit de Chemise Camisas de los cilindros лайнер комплект	CYL. LINER Zylinderlaufbuchse Chemise Camisas de los cilindros втулка цилиндра	PISTON + RINGS Kolben + Ringe Piston + Segments Pistón Set Поршень и кольца			PISTON SET Kolben Set Set de Piston Pistón Set поршневой	RINGS SET Kolben Set Segments de Piston Anillos Set кольца	PIN Pin Axe Perno Пин
<b>GM C 1.0 NE</b> 4 Cyl 71.1 mm Bore Ø 999 cc		Length: Outside Ø: Flange Ø: flange depth	Length:	58.25	Reference no.:	Top:	1.5	Ø: 18.0 Length: 50.0
			Comp:	37.25		2nd:	1.5	
			Height:	-1.84		3rd:	3.0	
			Reference no.:	Reference no.:	Reference no.:	Reference no.:	O-RING	
			<b>M-S14140</b>	<b>M-E14140</b>	<b>M-A14140</b>			
NM-Germany Article no. Artikelnummer/ Modelo Número / статья НОМЕР	NM-Germany Article no.	NM-Germany Article no.	NM-Germany Article no.	NM-Germany Article no.	NM-Germany Article no.	NM-Germany Article no.	NM-Germany Article no.	
			<b>KBSOP40494G</b>	<b>KBOP40494G</b>	<b>KROP40494G</b>			

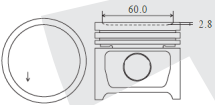

**GASOLINE**

ENGINE TYPE Motortyp Type de Moteur Tipo de motor Тип двигателя	LINER KIT Liner Kit Kit de Chemise Camisas de los cilindros лайнер комплект	CYL. LINER Zylinderlaufbuchse Chemise Camisas de los cilindros втулка цилиндра	PISTON + RINGS Kolben + Ringe Piston + Segments Pistón Set Поршень и кольца		PISTON SET Kolben Set Set de Piston Pistón Set поршневой	RINGS SET Kolben Set Segments de Piston Anillos Set кольца	PIN Pin Axe Perno Пин	
<b>1.0 N</b> <b>1.0 S</b> 4 Cyl 72.0 mm Bore Ø 993 cc 		Length: Outside Ø: Flange Ø: flange depth	Length:	76.0		Top:	2.0	Ø: 20.0 Length: 65.0
			Comp:	38.0		2nd:	2.0	
			Height:	-1.5		3rd:	5.0	
			Reference no.:	Reference no.:	Reference no.:	Reference no.:	O-RING	
				<b>H-21293</b> <b>K-91095600</b> <b>M-0112000</b>	<b>900 026 51</b> <b>900 026 52</b> <b>900 026 53</b> <b>900 026 54</b> <b>900 026 55</b> <b>900 026 56</b> <b>900 026 57</b> <b>900 051 02</b> <b>900 051 13</b> <b>900 073 43</b> <b>900 073 44</b> <b>900 073 45</b> <b>900 073 46</b> <b>900 073 47-58</b>	<b>A-R40240</b> <b>G-0830220000</b> <b>K-800020240000</b> <b>M-01120V0</b>		
NM-Germany Article no. Artikelnummer/ Modelo Número / статья НОМЕР	NM-Germany Article no.	NM-Germany Article no.	NM-Germany Article no.	NM-Germany Article no.	NM-Germany Article no.	NM-Germany Article no.	NM-Germany Article no.	
			KBSOP40495G	KBOP40495G	KROP40495G			

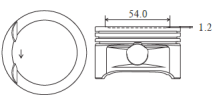

**GASOLINE**

ENGINE TYPE Motortyp Type de Moteur Tipo de motor Тип двигателя	LINER KIT Liner Kit Kit de Chemise Camisas de los cilindros лайнер комплект	CYL. LINER Zylinderlaufbuchse Chemise Camisas de los cilindros втулка цилиндра	PISTON + RINGS Kolben + Ringe Piston + Segments Pistón Set Поршень и кольца		PISTON SET Kolben Set Set de Piston Pistón Set поршневой	RINGS SET Kolben Set Segments de Piston Anillos Set кольца	PIN Pin Axe Perno Пин		
<b>X 1.2 SZ</b> 4 Cyl 72.0 mm Bore Ø 1,195 cc 		Length: Outside Ø: Flange Ø: flange depth		STD	O/S	Top:	1.5	Ø: 18.0 Length: 50.0	
			Length:	59.0	58.7		2nd:		1.5
			Comp:	32.05	31.75		3rd:		3.0
Height:	-2.8	-2.8	1st oil:						
			Reference no.:	Reference no.:	Reference no.:	Reference no.:	O-RING		
				<b>M-0115100</b> <b>K-94662600</b>		<b>A-R49590</b> <b>G-0830750000</b> <b>K-800036940000</b> <b>M-01150N0</b>			
NM-Germany Article no. Artikelnummer/ Modelo Número / статья НОМЕР	NM-Germany Article no.	NM-Germany Article no.	NM-Germany Article no.	NM-Germany Article no.	NM-Germany Article no.	NM-Germany Article no.	NM-Germany Article no.		
			KBSOP40496G	KBOP40496G	KROP40496G				

**GASOLINE**

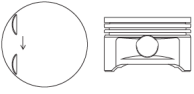

ENGINE TYPE Motortyp Type de Moteur Tipo de motor Тип двигателя	LINER KIT Liner Kit Kit de Chemise Camisas de los cilindros лайнер комплект	CYL. LINER Zylinderlaufbuchse Chemise Camisas de los cilindros втулка цилиндра	PISTON + RINGS Kolben + Ringe Piston + Segments Pistón Set Поршень и кольца		PISTON SET Kolben Set Set de Piston Pistón Set поршневой	RINGS SET Kolben Set Segments de Piston Anillos Set кольца	PIN Pin Axe Perno Пин	
<b>X 1.0 XE</b> <b>Z 1.0 XE</b> 3 Cyl 72.5 mm Bore Ø 973 cc 		Length: Outside Ø: Flange Ø: flange depth	Length:	45.0		Top:	1.2	Ø: 18.0 Length: 51.0
			Comp:	24.0		2nd:	1.5	
			Height:	-1.2		3rd:	2.0	
			Reference no.:	Reference no.:	Reference no.:	Reference no.:	O-RING	
				<b>A-24123</b> <b>K-40382600</b> <b>M-0120100</b> <b>N-8710270000</b>		<b>A-R49990</b> <b>G-0810270000</b> <b>K-800070940000</b> <b>M-01184N0</b>		
NM-Germany Article no. Artikelnummer/ Modelo Número / статья НОМЕР	NM-Germany Article no.	NM-Germany Article no.	NM-Germany Article no.	NM-Germany Article no.	NM-Germany Article no.	NM-Germany Article no.	NM-Germany Article no.	
			KBSOP30497G	KBOP30497G	KROP30497G			

**GASOLINE**

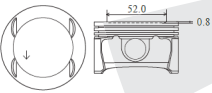

ENGINE TYPE Motortyp Type de Moteur Tipo de motor Тип двигателя	LINER KIT Liner Kit Kit de Chemise Camisas de los cilindros лайнер комплект	CYL. LINER Zylinderlaufbuchse Chemise Camisas de los cilindros втулка цилиндра	PISTON + RINGS Kolben + Ringe Piston + Segments Pistón Set Поршень и кольца			PISTON SET Kolben Set Set de Piston Pistón Set поршневой	RINGS SET Kolben Set Segments de Piston Anillos Set кольца	PIN Pin Axe Perno Пин
<b>X 1.2 XE</b> <b>Z 1.2 XE</b> 4 Cyl 72.5 mm Bore Ø 1,199 cc 		Length:		Length:	45.0	Top: 1.2 2nd: 1.5 3rd: 1st oil: 2.0 2nd oil:	Ø: 18.0 Length: 51.0	
		Outside Ø:		Comp:	24.0			
		Flange Ø:		Height:	-1.3			
		flange depth						
		Reference no.:	Reference no.:			Reference no.:	O-RING	
			<b>A-24124</b> <b>K-40383600</b> <b>M-0118400</b> <b>N-8710270010</b>			<b>A-R49990</b> <b>G-0810270000</b> <b>K-800070940000</b> <b>M-01184N0</b>		
NM-Germany Article no. Artikelnummer/ Modelo Número / статья НОМЕР	NM-Germany Article no.	NM-Germany Article no.	NM-Germany Article no.			NM-Germany Article no.	NM-Germany Article no.	
			KBSOP40498G			KBOP40498G	KROP40498G	

OPEL

**GASOLINE**

ENGINE TYPE Motortyp Type de Moteur Tipo de motor Тип двигателя	LINER KIT Liner Kit Kit de Chemise Camisas de los cilindros лайнер комплект	CYL. LINER Zylinderlaufbuchse Chemise Camisas de los cilindros втулка цилиндра	PISTON + RINGS Kolben + Ringe Piston + Segments Pistón Set Поршень и кольца			PISTON SET Kolben Set Set de Piston Pistón Set поршневой	RINGS SET Kolben Set Segments de Piston Anillos Set кольца	PIN Pin Axe Perno Пин
<b>Z 1.0 XEP</b> 3 Cyl 73.4 mm Bore Ø 998 cc 		Length:		Length:	45.0	Top: 1.2 2nd: 1.2 3rd: 1st oil: 2.0 2nd oil:	Ø: 18.0 Length: 51.0	
		Outside Ø:		Comp:	24.0			
		Flange Ø:		Height:	-0.8			
		flange depth						
		Reference no.:	Reference no.:			Reference no.:	O-RING	
			<b>K-40384600</b> <b>M-0121800</b>			<b>K-800071010000</b> <b>M-01218N0</b>		
NM-Germany Article no. Artikelnummer/ Modelo Número / статья НОМЕР	NM-Germany Article no.	NM-Germany Article no.	NM-Germany Article no.			NM-Germany Article no.	NM-Germany Article no.	
			KBSOP30499G			KBOP30499G	KROP30499G	

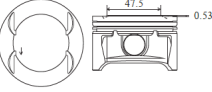
**GASOLINE**

ENGINE TYPE Motortyp Type de Moteur Tipo de motor Тип двигателя	LINER KIT Liner Kit Kit de Chemise Camisas de los cilindros лайнер комплект	CYL. LINER Zylinderlaufbuchse Chemise Camisas de los cilindros втулка цилиндра	PISTON + RINGS Kolben + Ringe Piston + Segments Pistón Set Поршень и кольца			PISTON SET Kolben Set Set de Piston Pistón Set поршневой	RINGS SET Kolben Set Segments de Piston Anillos Set кольца	PIN Pin Axe Perno Пин
<b>Z 1.2 XEP</b> 4 Cyl 73.4 mm Bore Ø 1,199 cc 		Length:		Length:	45.53	Top: 1.2 2nd: 1.2 3rd: 1st oil: 2.0 2nd oil:	Ø: 18.0 Length: 51.0	
		Outside Ø:		Comp:	24.0			
		Flange Ø:		Height:	0.53			
		flange depth						
		Reference no.:	Reference no.:			Reference no.:	O-RING	
			<b>K-40385600</b> <b>M-0122200</b>			<b>K-800071010000</b> <b>M-01218N0</b>		
NM-Germany Article no. Artikelnummer/ Modelo Número / статья НОМЕР	NM-Germany Article no.	NM-Germany Article no.	NM-Germany Article no.			NM-Germany Article no.	NM-Germany Article no.	
			KBSOP40500G			KBOP40500G	KROP40500G	

**GASOLINE**

ENGINE TYPE Motortyp Type de Moteur Tipo de motor Тип двигателя	LINER KIT Liner Kit Kit de Chemise Camisas de los cilindros лайнер комплект	CYL. LINER Zylinderlaufbuchse Chemise Camisas de los cilindros втулка цилиндра	PISTON + RINGS Kolben + Ringe Piston + Segments Pistón Set Поршень и кольца		PISTON SET Kolben Set Set de Piston Pistón Set поршневой	RINGS SET Kolben Set Segments de Piston Anillos Set кольца	PIN Pin Axe Perno Пин	
<b>Z 1.4 XEP</b> 4 Cyl 73.4 mm Bore Ø 1,364 cc		Length: Outside Ø: Flange Ø: flange depth	Length:	44.0	head, top and 2nd ring lands anodized skirt MOS2 treated	Top:	1.2	Ø: 18.0 Length: 51.0
			Comp:	23.0		2nd:	1.2	
			Height:	-1.25		3rd:	2.0	
			Reference no.:	Reference no.:	Reference no.:	Reference no.:	O-RING	
				<b>K-40386600</b> <b>M-0121900</b>		<b>K-800071010000</b> <b>M-01218N0</b>		
NM-Germany Article no. Artikelnummer/ Modelo Número / статья НОМЕР	NM-Germany Article no.	NM-Germany Article no.	NM-Germany Article no.	NM-Germany Article no.	NM-Germany Article no.	NM-Germany Article no.	NM-Germany Article no.	
			<b>KBSOP40501G</b>	<b>KBOP40501G</b>	<b>KROP40501G</b>			

**GASOLINE**

ENGINE TYPE Motortyp Type de Moteur Tipo de motor Тип двигателя	LINER KIT Liner Kit Kit de Chemise Camisas de los cilindros лайнер комплект	CYL. LINER Zylinderlaufbuchse Chemise Camisas de los cilindros втулка цилиндра	PISTON + RINGS Kolben + Ringe Piston + Segments Pistón Set Поршень и кольца		PISTON SET Kolben Set Set de Piston Pistón Set поршневой	RINGS SET Kolben Set Segments de Piston Anillos Set кольца	PIN Pin Axe Perno Пин	
<b>13S</b> <b>13SB C 13 N</b> 4 Cyl 75.0 mm Bore Ø 1,297 cc		Length: Outside Ø: Flange Ø: flange depth	Length:	62.4	STD O/S	Top:	1.5	Ø: 20.0 Length: 65.0
			Comp:	35.8		62.1	2nd:	
			Height:	-3.6		3rd:	4.0	
			Reference no.:	Reference no.:	Reference no.:	Reference no.:	O-RING	
				<b>H-21776</b> <b>K-93868600</b> <b>M-0112600</b> <b>N-8730630700</b>	<b>900 069 59</b> <b>900 069 60</b> <b>900 069 62</b> <b>900 069 63</b> <b>900 069 64</b> <b>900 069 65</b> <b>900 069 67</b> <b>900 069 68</b> <b>900 069 70</b> <b>900 069 71</b> <b>900 069 72</b> <b>900 069 73~77</b> <b>900 069 80</b> <b>901 080 23</b>	<b>A-R41270</b> <b>G-0830630000</b> <b>K-800020340000</b> <b>M-01126N0</b> <b>T-50013</b>		
NM-Germany Article no. Artikelnummer/ Modelo Número / статья НОМЕР	NM-Germany Article no.	NM-Germany Article no.	NM-Germany Article no.	NM-Germany Article no.	NM-Germany Article no.	NM-Germany Article no.	NM-Germany Article no.	
			<b>KBSOP40502G</b>	<b>KBOP40502G</b>	<b>KROP40502G</b>			

**GASOLINE**

ENGINE TYPE Motortyp Type de Moteur Tipo de motor Тип двигателя	LINER KIT Liner Kit Kit de Chemise Camisas de los cilindros лайнер комплект	CYL. LINER Zylinderlaufbuchse Chemise Camisas de los cilindros втулка цилиндра	PISTON + RINGS Kolben + Ringe Piston + Segments Pistón Set Поршень и кольца		PISTON SET Kolben Set Set de Piston Pistón Set поршневой	RINGS SET Kolben Set Segments de Piston Anillos Set кольца	PIN Pin Axe Perno Пин	
<b>13S</b> <b>13SB C 13 N</b> 4 Cyl 75.0 mm Bore Ø 1,297 cc		Length: Outside Ø: Flange Ø: flange depth	Length:	62.1		Top:	1.5	Ø: 20.0 Length: 65.0
			Comp:	35.6		2nd:	1.5	
			Height:	-3.7		3rd:	4.0	
			Reference no.:	Reference no.:	Reference no.:	Reference no.:	O-RING	
						<b>A-R41270</b> <b>G-0830630000</b> <b>K-800020340000</b> <b>M-01126N0</b> <b>T-50013</b>		
NM-Germany Article no. Artikelnummer/ Modelo Número / статья НОМЕР	NM-Germany Article no.	NM-Germany Article no.	NM-Germany Article no.	NM-Germany Article no.	NM-Germany Article no.	NM-Germany Article no.	NM-Germany Article no.	
			<b>KBSOP40503G</b>	<b>KBOP40503G</b>	<b>KROP40503G</b>			



**GASOLINE**

ENGINE TYPE Motortyp Type de Moteur Tipo de motor Тип двигателя	LINER KIT Liner Kit Kit de Chemise Camisas de los cilindros лайнер комплект	CYL. LINER Zylinderlaufbuchse Chemise Camisas de los cilindros втулка цилиндра	PISTON + RINGS Kolben + Ringe Piston + Segments Pistón Set Поршень и кольца		PISTON SET Kolben Set Set de Piston Pistón Set поршневой	RINGS SET Kolben Set Segments de Piston Anillos Set кольца	PIN Pin Axe Perno Пин	
<b>1.3 NE</b> 4 Cyl 75.0 mm Bore Ø 1,297 cc		Length: Outside Ø: Flange Ø: flange depth	Length:	53.1	Reference no.:	Top:	1.5	Ø: 18.0 Length: 50.0
			Comp:	32.1		2nd:	1.5	
			Height:	-3.3		3rd:	3.0	
			Reference no.:	Reference no.:	Reference no.:	Reference no.:	O-RING	
NM-Germany Article no. Artikelnummer/ Modelo Número / статья НОМЕР	NM-Germany Article no.	NM-Germany Article no.	NM-Germany Article no.	NM-Germany Article no.	NM-Germany Article no.	NM-Germany Article no.	NM-Germany Article no.	
			KBSOP40504G	KBOP40504G	KROP40504G			

OPEL



**GASOLINE**

ENGINE TYPE Motortyp Type de Moteur Tipo de motor Тип двигателя	LINER KIT Liner Kit Kit de Chemise Camisas de los cilindros лайнер комплект	CYL. LINER Zylinderlaufbuchse Chemise Camisas de los cilindros втулка цилиндра	PISTON + RINGS Kolben + Ringe Piston + Segments Pistón Set Поршень и кольца		PISTON SET Kolben Set Set de Piston Pistón Set поршневой	RINGS SET Kolben Set Segments de Piston Anillos Set кольца	PIN Pin Axe Perno Пин	
<b>1.3 NE</b> 4 Cyl 75.0 mm Bore Ø 1,297 cc		Length: Outside Ø: Flange Ø: flange depth	Length:	53.1	Reference no.:	Top:	1.5	Ø: 18.0 Length: 50.0
			Comp:	32.1		2nd:	1.5	
			Height:	-3.3		3rd:	4.0	
			Reference no.:	Reference no.:	Reference no.:	Reference no.:	O-RING	
						A-R41270 G-0830630000 K-800020340000 M-01126N0 T-50013		
NM-Germany Article no. Artikelnummer/ Modelo Número / статья НОМЕР	NM-Germany Article no.	NM-Germany Article no.	NM-Germany Article no.	NM-Germany Article no.	NM-Germany Article no.	NM-Germany Article no.	NM-Germany Article no.	
			KBSOP40505G	KBOP40505G	KROP40505G			

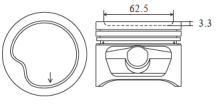

**GASOLINE**

ENGINE TYPE Motortyp Type de Moteur Tipo de motor Тип двигателя	LINER KIT Liner Kit Kit de Chemise Camisas de los cilindros лайнер комплект	CYL. LINER Zylinderlaufbuchse Chemise Camisas de los cilindros втулка цилиндра	PISTON + RINGS Kolben + Ringe Piston + Segments Pistón Set Поршень и кольца		PISTON SET Kolben Set Set de Piston Pistón Set поршневой	RINGS SET Kolben Set Segments de Piston Anillos Set кольца	PIN Pin Axe Perno Пин			
<b>1.3 N</b> <b>1.3 NB</b> 4 Cyl 75.0 mm Bore Ø 1,297 cc		Length: Outside Ø: Flange Ø: flange depth	Length:	62.4	Reference no.:	Top:	1.5	Ø: 20.0 Length: 65.0		
			Comp:	35.8		O/S			2nd:	1.5
			Height:	-6.8		-6.8	3rd:		4.0	
			Reference no.:	Reference no.:	Reference no.:	Reference no.:	O-RING			
				H-21777 K-93867700 M-0112700	900 769 05	A-R41270 G-0830630000 K-800020340000 M-01126N0 T-50013				
NM-Germany Article no. Artikelnummer/ Modelo Número / статья НОМЕР	NM-Germany Article no.	NM-Germany Article no.	NM-Germany Article no.	NM-Germany Article no.	NM-Germany Article no.	NM-Germany Article no.	NM-Germany Article no.			
			KBSOP40506G	KBOP40506G	KROP40506G					

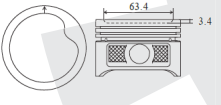

**GASOLINE**

ENGINE TYPE Motortyp Type de Moteur Tipo de motor Тип двигателя	LINER KIT Liner Kit Kit de Chemise Camisas de los cilindros лайнер комплект	CYL. LINER Zylinderlaufbuchse Chemise Camisas de los cilindros втулка цилиндра	PISTON + RINGS Kolben + Ringe Piston + Segments Pistón Set Поршень и кольца		PISTON SET Kolben Set Set de Piston Pistón Set поршень	RINGS SET Kolben Set Segments de Piston Anillos Set кольца	PIN Pin Axe Perno Пин	
<b>1.4 NV/NVH C 1.4 NZ</b> <b>X 1.4 SZ</b> 4 Cyl 77.6 mm Bore Ø 1,396 cc 		Length: Outside Ø: Flange Ø: flange depth	Length:	59.0		Top:	1.5	Ø: 18.0 Length: 55.0
			Comp:	32.0		2nd:	1.5	
			Height:	-3.3		3rd:	3.0	
			Reference no.:	Reference no.:	Reference no.:	Reference no.:	O-RING	
				<b>A-23707V1</b> <b>M-0110600</b> <b>N-8730710020</b>	<b>903 246 66</b>	<b>903 246 89</b> <b>A-R43740</b> <b>G-0830710000</b> <b>K-800020540000</b> <b>M-01106N0</b> <b>T-50012</b>		
NM-Germany Article no. Artikelnummer/ Modelo Número / статья НОМЕР	NM-Germany Article no.	NM-Germany Article no.	NM-Germany Article no.	NM-Germany Article no.	NM-Germany Article no.	NM-Germany Article no.	NM-Germany Article no.	
			KBSOP40507G	KBOP40507G	KROP40507G			

**GASOLINE**

ENGINE TYPE Motortyp Type de Moteur Tipo de motor Тип двигателя	LINER KIT Liner Kit Kit de Chemise Camisas de los cilindros лайнер комплект	CYL. LINER Zylinderlaufbuchse Chemise Camisas de los cilindros втулка цилиндра	PISTON + RINGS Kolben + Ringe Piston + Segments Pistón Set Поршень и кольца		PISTON SET Kolben Set Set de Piston Pistón Set поршень	RINGS SET Kolben Set Segments de Piston Anillos Set кольца	PIN Pin Axe Perno Пин
<b>1.4 NV/NVH C 1.4 NZ</b> <b>X 1.4 SZ/NZ</b> 4 Cyl 77.6 mm Bore Ø 1,389 cc 		Length: Outside Ø: Flange Ø: flange depth		STD	O/S	Top: 1.5 2nd: 1.5 3rd: 3.0 1st oil: 3.0 2nd oil:	Ø: 18.0 Length: 55.0
			Length:	52.5	52.5		
			Comp:	32.0	31.7		
			Reference no.:	Reference no.:	Reference no.:	Reference no.:	O-RING
				<b>K-97286600</b>		<b>903 246 89</b> <b>A-R43740</b> <b>G-0830710000</b> <b>K-800020540000</b> <b>M-01106N0</b> <b>T-50012</b>	
NM-Germany Article no. Artikelnummer/ Modelo Número / статья НОМЕР	NM-Germany Article no.	NM-Germany Article no.	NM-Germany Article no.	NM-Germany Article no.	NM-Germany Article no.	NM-Germany Article no.	NM-Germany Article no.
			KBSOP40508G	KBOP40508G	KROP40508G		

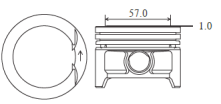
**GASOLINE**

ENGINE TYPE Motortyp Type de Moteur Tipo de motor Тип двигателя	LINER KIT Liner Kit Kit de Chemise Camisas de los cilindros лайнер комплект	CYL. LINER Zylinderlaufbuchse Chemise Camisas de los cilindros втулка цилиндра	PISTON + RINGS Kolben + Ringe Piston + Segments Pistón Set Поршень и кольца		PISTON SET Kolben Set Set de Piston Pistón Set поршень	RINGS SET Kolben Set Segments de Piston Anillos Set кольца	PIN Pin Axe Perno Пин	
<b>C 1.4 SEL</b> <b>C 1.4 NC/NE</b> <b>C 1.4 NZ/SZ/XE</b> 4 Cyl 77.6 mm Bore Ø 1,389 cc 		Length: Outside Ø: Flange Ø: flange depth	Length:	57.05		Top:	1.5	Ø: 18.0 Length: 55.0
			Comp:	32.05				
			Height:	1.0				
			Reference no.:	Reference no.:	Reference no.:	Reference no.:	O-RING	
				<b>H-24052</b> <b>K-94798600</b> <b>M-0110200</b> <b>N-8730710030</b>	<b>904 702 19</b>	<b>903 246 89</b> <b>A-R43740</b> <b>G-0830710000</b> <b>K-800020540000</b> <b>M-01106N0</b> <b>T-50012</b>		
NM-Germany Article no. Artikelnummer/ Modelo Número / статья НОМЕР	NM-Germany Article no.	NM-Germany Article no.	NM-Germany Article no.	NM-Germany Article no.	NM-Germany Article no.	NM-Germany Article no.	NM-Germany Article no.	
			KBSOP40509G	KBOP40509G	KROP40509G			

## GASOLINE

ENGINE TYPE Motortyp Type de Moteur Tipo de motor Тип двигателя	LINER KIT Liner Kit Kit de Chemise Camisas de los cilindros лайнер комплект	CYL. LINER Zylinderlaufbuchse Chemise Camisas de los cilindros втулка цилиндра	PISTON + RINGS Kolben + Ringe Piston + Segments Pistón Set Поршень и кольца		PISTON SET Kolben Set Set de Piston Pistón Set поршневой	RINGS SET Kolben Set Segments de Piston Anillos Set кольца	PIN Pin Axe Perno Пин					
<b>Z 1.4 XE</b> 4 Cyl 77.6 mm Bore Ø 1,389 cc		Length: Outside Ø: Flange Ø: flange depth	Length: Comp: Height:	55.75 31.3 2.45		Top: 1.2 2nd: 1.5 3rd: 2.0 1st oil: 2nd oil:	Ø: 18.0 Length: 55.0					
								Reference no.:	Reference no.:	Reference no.:	Reference no.:	O-RING
									<b>M-0121000</b>		<b>G-0814420000</b> <b>M-01210N0</b>	
NM-Germany Article no. Artikelnummer/ Modelo Número / статья НОМЕР	NM-Germany Article no.	NM-Germany Article no.	NM-Germany Article no.	NM-Germany Article no.	NM-Germany Article no.	NM-Germany Article no.	NM-Germany Article no.					
			<b>KBSOP40510G</b>	<b>KBOP40510G</b>	<b>KROP40510G</b>							

OPEL



## DIESEL



ENGINE TYPE Motortyp Type de Moteur Tipo de motor Тип двигателя	LINER KIT Liner Kit Kit de Chemise Camisas de los cilindros лайнер комплект	CYL. LINER Zylinderlaufbuchse Chemise Camisas de los cilindros втулка цилиндра	PISTON + RINGS Kolben + Ringe Piston + Segments Pistón Set Поршень и кольца		PISTON SET Kolben Set Set de Piston Pistón Set поршневой	RINGS SET Kolben Set Segments de Piston Anillos Set кольца	PIN Pin Axe Perno Пин	
<b>17 TD</b> <b>X 17 TD</b> 4 Cyl 79.0 mm Bore Ø 1,686 cc		Length: Outside Ø: Flange Ø: flange depth	(A)	(B)	Length: Comp: Height:	alfin Top: 2.0 2nd: 1.5 3rd: 3.0 1st oil: 2nd oil:	Ø: 27.0 Length: 64.0	
			144.0	144.0				69.7
			83.0	83.0				39.7
NM-Germany Article no. Artikelnummer/ Modelo Número / статья НОМЕР	NM-Germany Article no.	NM-Germany Article no.	NM-Germany Article no.	NM-Germany Article no.	NM-Germany Article no.	NM-Germany Article no.	NM-Germany Article no.	
	<b>LBSOP40511DPA</b> <b>LBSOP40511DSA</b>	<b>LBOP40511DPA(A)</b> <b>LBOP40511DSA(B)</b>	<b>KBSOP40511DA</b>	<b>KBOP40511DA</b>	<b>A-A350931</b> <b>K-94861600</b> <b>M-6292000</b> <b>N-8730760030</b>	<b>A-R48400</b> <b>G-0830760000</b> <b>K-800071940000</b> <b>M-62920V0</b>		

## DIESEL

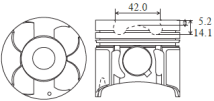

ENGINE TYPE Motortyp Type de Moteur Tipo de motor Тип двигателя	LINER KIT Liner Kit Kit de Chemise Camisas de los cilindros лайнер комплект	CYL. LINER Zylinderlaufbuchse Chemise Camisas de los cilindros втулка цилиндра	PISTON + RINGS Kolben + Ringe Piston + Segments Pistón Set Поршень и кольца		PISTON SET Kolben Set Set de Piston Pistón Set поршневой	RINGS SET Kolben Set Segments de Piston Anillos Set кольца	PIN Pin Axe Perno Пин	
<b>Y 17 DT</b> <b>Y 17 DTL</b> 4 Cyl 79.0 mm Bore Ø 1,686 cc		Length: Outside Ø: Flange Ø: flange depth	(A)	(B)	Length: Comp: Height:	alfin skirt MOS2 treated Top: 2.0 2nd: 1.5 3rd: 3.0 1st oil: 2nd oil:	Ø: 27.0 Length: 64.0	
			144.0	144.0				84.0
			83.0	83.0				39.7
NM-Germany Article no. Artikelnummer/ Modelo Número / статья НОМЕР	NM-Germany Article no.	NM-Germany Article no.	NM-Germany Article no.	NM-Germany Article no.	NM-Germany Article no.	NM-Germany Article no.	NM-Germany Article no.	
	<b>LBSOP40512DPA</b> <b>LBSOP40512DSA</b>	<b>LBOP40512DPA(A)</b> <b>LBOP40512DSA(B)</b>	<b>KBSOP40512DA</b>	<b>KBOP40512DA</b>	<b>A-A350601</b> <b>N-8730760040</b>	<b>A-R48400</b> <b>G-0830760000</b> <b>K-800071940000</b> <b>M-62920V0</b>		

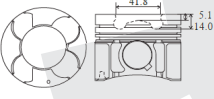
**DIESEL**

ENGINE TYPE Motortyp Type de Moteur Tipo de motor Тип двигателя	LINER KIT Liner Kit Kit de Chemise Camisas de los cilindros лайнер комплект	CYL. LINER Zylinderlaufbuchse Chemise Camisas de los cilindros втулка цилиндра	(A)		(B)		PISTON + RINGS Kolben + Ringe Piston + Segments Pistón Set Поршень и кольца	PISTON SET Kolben Set Set de Piston Pistón Set поршень	RINGS SET Kolben Set Segments de Piston Anillos Set кольца	PIN Pin Axe Perno Пин	
<b>Z 17 DTL</b> 4 Cyl 79.0 mm Bore Ø 1,686 cc 		Length: 144.0 144.0 Outside Ø: 83.0 83.0 Flange Ø: 87.0 flange depth 2.0	Length: 74.0 Comp: 39.8 Height: -5.2 -14.1	alfin skirt MOS2 treated	Top: 2.0 2nd: 1.5 3rd: 3.0 1st oil: 2nd oil:	Ø: 27.0 Length: 64.0	Reference no.:	Reference no.:	Reference no.:	Reference no.:	O-RING
								<b>K-40390600</b>	<b>S623199</b> <b>S623200</b> <b>S623201</b> <b>S623283</b> <b>S623284/5</b>	<b>A-R48400</b> <b>G-0830760000</b> <b>K-800071940000</b> <b>M-62920V0</b>	
							NM-Germany Article no. Artikelnummer/ Modelo Número / статья НОМЕР	NM-Germany Article no.	NM-Germany Article no.	NM-Germany Article no.	NM-Germany Article no.
	<b>LBSOP40513DPA</b> <b>LBSOP40513DSA</b>	<b>LBOP40513DPA(A)</b> <b>LBOP40513DSA(B)</b>	<b>KBSOP40513DA</b>	<b>KBOP40513DA</b>	<b>KROP40513D</b>						

ENGINE TYPE Motortyp Type de Moteur Tipo de motor Тип двигателя	LINER KIT Liner Kit Kit de Chemise Camisas de los cilindros лайнер комплект	CYL. LINER Zylinderlaufbuchse Chemise Camisas de los cilindros втулка цилиндра	(A)		(B)		PISTON + RINGS Kolben + Ringe Piston + Segments Pistón Set Поршень и кольца	PISTON SET Kolben Set Set de Piston Pistón Set поршень	RINGS SET Kolben Set Segments de Piston Anillos Set кольца	PIN Pin Axe Perno Пин	
<b>Z 17 DTH</b> 4 Cyl 79.0 mm Bore Ø 1,686 cc 		Length: 144.0 144.0 Outside Ø: 83.0 83.0 Flange Ø: 87.0 flange depth 2.0	Length: 64.7 Comp: 39.7 Height: -5.1 -14.0	alfin and with oil gallery skirt MOS2 treated	Top: 2.0 2nd: 1.5 3rd: 3.0 1st oil: 2nd oil:	Ø: 27.0 Length: 64.0	Reference no.:	Reference no.:	Reference no.:	Reference no.:	O-RING
								<b>K-40392600</b>		<b>A-R48400</b> <b>G-0830760000</b> <b>K-800071940000</b> <b>M-62920V0</b>	
							NM-Germany Article no. Artikelnummer/ Modelo Número / статья НОМЕР	NM-Germany Article no.	NM-Germany Article no.	NM-Germany Article no.	NM-Germany Article no.
	<b>LBSOP40514DPA</b> <b>LBSOP40514DSA</b>	<b>LBOP40514DPA(A)</b> <b>LBOP40514DSA(B)</b>	<b>KBSOP40514DA</b>	<b>KBOP40514DA</b>	<b>KROP40514D</b>						

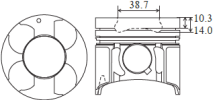
**DIESEL**

ENGINE TYPE Motortyp Type de Moteur Tipo de motor Тип двигателя	LINER KIT Liner Kit Kit de Chemise Camisas de los cilindros лайнер комплект	CYL. LINER Zylinderlaufbuchse Chemise Camisas de los cilindros втулка цилиндра	(A)		(B)		PISTON + RINGS Kolben + Ringe Piston + Segments Pistón Set Поршень и кольца	PISTON SET Kolben Set Set de Piston Pistón Set поршень	RINGS SET Kolben Set Segments de Piston Anillos Set кольца	PIN Pin Axe Perno Пин	
<b>Y 17 DT</b> <b>Y 17 L</b> 4 Cyl 79.0 mm Bore Ø 1,686 cc 		Length: 144.0 144.0 Outside Ø: 83.0 83.0 Flange Ø: 87.0 flange depth 2.0	Length: 74.0 Comp: 39.8 Height: -10.3 -14.0	alfin skirt MOS2 treated	Top: 2.0 2nd: 1.5 3rd: 3.0 1st oil: 2nd oil:	Ø: 27.0 Length: 64.0	Reference no.:	Reference no.:	Reference no.:	Reference no.:	O-RING
								<b>K-40391600</b>		<b>A-R48400</b> <b>G-0830760000</b> <b>K-800071940000</b> <b>M-62920V0</b>	
							NM-Germany Article no. Artikelnummer/ Modelo Número / статья НОМЕР	NM-Germany Article no.	NM-Germany Article no.	NM-Germany Article no.	NM-Germany Article no.
	<b>LBSOP40515DPA</b> <b>LBSOP40515DSA</b>	<b>LBOP40515DPA(A)</b> <b>LBOP40515DSA(B)</b>	<b>KBSOP40515DA</b>	<b>KBOP40515DA</b>	<b>KROP40515D</b>						

**GASOLINE**

ENGINE TYPE Motortyp Type de Moteur Tipo de motor Тип двигателя	LINER KIT Liner Kit Kit de Chemise Camisas de los cilindros лайнер комплект	CYL. LINER Zylinderlaufbuchse Chemise Camisas de los cilindros втулка цилиндра	PISTON + RINGS Kolben + Ringe Piston + Segments Pistón Set Поршень и кольца		PISTON SET Kolben Set Set de Piston Pistón Set поршневой	RINGS SET Kolben Set Segments de Piston Anillos Set кольца	PIN Pin Axe Perno Пин	
<b>1.6 SV C 1.6 SE E 1.6 SE</b> 4 Cyl 79.0 mm Bore Ø 1,598 cc		Length: Outside Ø: Flange Ø: flange depth	Length:	48.3		Top:	1.2	Ø: 18.0 Length: 55.0
			Comp:	28.1		2nd:	1.5	
			Height:	0.2		3rd:	3.0	
			flange depth	-1.6		1st oil:		
						2nd oil:		
			Reference no.:	Reference no.:	Reference no.:	Reference no.:	O-RING	
				<b>H-22304 K-90556605 M-0111000 N-8730690010</b>	<b>902 295 885 902 958 83 902 958 84 902 958 85 902 958 86 902 982 57</b>	<b>A-R43150 G-0830690000 K-800020740000 M-01108N0 T-50011</b>		
NM-Germany Article no. Artikelnummer/ Modelo Número / статья НОМЕР	NM-Germany Article no.	NM-Germany Article no.	NM-Germany Article no.	NM-Germany Article no.	NM-Germany Article no.	NM-Germany Article no.	NM-Germany Article no.	
			<b>KBSOP40516G</b>	<b>KBOP40516G</b>	<b>KROP40516G</b>			

OPEL

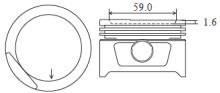

**GASOLINE**

ENGINE TYPE Motortyp Type de Moteur Tipo de motor Тип двигателя	LINER KIT Liner Kit Kit de Chemise Camisas de los cilindros лайнер комплект	CYL. LINER Zylinderlaufbuchse Chemise Camisas de los cilindros втулка цилиндра	PISTON + RINGS Kolben + Ringe Piston + Segments Pistón Set Поршень и кольца		PISTON SET Kolben Set Set de Piston Pistón Set поршневой	RINGS SET Kolben Set Segments de Piston Anillos Set кольца	PIN Pin Axe Perno Пин	
<b>C 1.6 NZ E 1.6 NZ X 1.6 SZR</b> 4 Cyl 79.0 mm Bore Ø 1,598 cc		Length: Outside Ø: Flange Ø: flange depth	Length:	48.5	STD	O/S	Top: 1.2 2nd: 1.5 3rd: 3.0 1st oil: 2nd oil:	Ø: 18.0 Length: 55.0
			Comp:	27.9	27.6			
			Height:	+0.3	+0.3			
			flange depth	-2.7	-2.7			
			Reference no.:	Reference no.:	Reference no.:	Reference no.:	O-RING	
				<b>H-22305 K-90555605 M-0110800 N-8730690000</b>	<b>902 970 83 902 987 78</b>	<b>A-R43150 G-0830690000 K-800020740000 M-01108N0 T-50011</b>		
NM-Germany Article no. Artikelnummer/ Modelo Número / статья НОМЕР	NM-Germany Article no.	NM-Germany Article no.	NM-Germany Article no.	NM-Germany Article no.	NM-Germany Article no.	NM-Germany Article no.	NM-Germany Article no.	
			<b>KBSOP40517G</b>	<b>KBOP40517G</b>	<b>KROP40517G</b>			

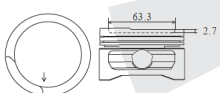



**GASOLINE**

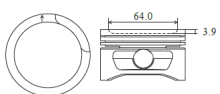

ENGINE TYPE Motortyp Type de Moteur Tipo de motor Тип двигателя	LINER KIT Liner Kit Kit de Chemise Camisas de los cilindros лайнер комплект	CYL. LINER Zylinderlaufbuchse Chemise Camisas de los cilindros втулка цилиндра	PISTON + RINGS Kolben + Ringe Piston + Segments Pistón Set Поршень и кольца		PISTON SET Kolben Set Set de Piston Pistón Set поршневой	RINGS SET Kolben Set Segments de Piston Anillos Set кольца	PIN Pin Axe Perno Пин	
<b>16 LZ KAT C 1.6 LZ</b> 4 Cyl 79.0 mm Bore Ø 1,598 cc		Length: Outside Ø: Flange Ø: flange depth	Length:	48.4	STD	O/S	Top: 1.2 2nd: 1.5 3rd: 3.0 1st oil: 2nd oil:	Ø: 18.0 Length: 55.0
			Comp:	28.0	27.7			
			Height:	+0.4	+0.4			
			flange depth	-3.9	-3.9			
			Reference no.:	Reference no.:	Reference no.:	Reference no.:	O-RING	
				<b>K-90054605 M-0110900</b>	<b>MO-102656700</b>	<b>A-R43150 G-0830690000 K-800020740000 M-01108N0 T-50011</b>		
NM-Germany Article no. Artikelnummer/ Modelo Número / статья НОМЕР	NM-Germany Article no.	NM-Germany Article no.	NM-Germany Article no.	NM-Germany Article no.	NM-Germany Article no.	NM-Germany Article no.	NM-Germany Article no.	
			<b>KBSOP40518G</b>	<b>KBOP40518G</b>	<b>KROP40518G</b>			

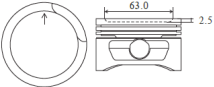

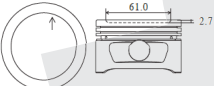

**GASOLINE**

ENGINE TYPE Motortyp Type de Moteur Tipo de motor Тип двигателя	LINER KIT Liner Kit Kit de Chemise Camisas de los cilindros лайнер комплект	CYL. LINER Zylinderlaufbuchse Chemise Camisas de los cilindros втулка цилиндра	PISTON + RINGS Kolben + Ringe Piston + Segments Pistón Set Поршень и кольца			PISTON SET Kolben Set Set de Piston Pistón Set поршневой	RINGS SET Kolben Set Segments de Piston Anillos Set кольца	PIN Pin Axe Perno Пин			
<b>1.6 ECOTEC</b> 4 Cyl 79.0 mm Bore Ø 1,598 cc 		Length: Outside Ø: Flange Ø: flange depth	Length: 48.5 Comp: 27.8 Height: 0.6 -2.5			Top: 1.2 2nd: 1.5 3rd: 3.0 1st oil: 2nd oil:	Ø: 18.0 Length: 55.0				
						Reference no.:		Reference no.:	Reference no.:	Reference no.:	O-RING
										A-R43150 G-0830690000 K-800020740000 M-01108N0 T-50011	
NM-Germany Article no. Artikelnummer/ Modelo Número / статья НОМЕР	NM-Germany Article no.	NM-Germany Article no.	NM-Germany Article no.	NM-Germany Article no.	NM-Germany Article no.	NM-Germany Article no.	NM-Germany Article no.				
			KBSOP40519G	KBOP40519G	KROP40519G						

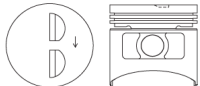

**GASOLINE**

ENGINE TYPE Motortyp Type de Moteur Tipo de motor Тип двигателя	LINER KIT Liner Kit Kit de Chemise Camisas de los cilindros лайнер комплект	CYL. LINER Zylinderlaufbuchse Chemise Camisas de los cilindros втулка цилиндра	PISTON + RINGS Kolben + Ringe Piston + Segments Pistón Set Поршень и кольца			PISTON SET Kolben Set Set de Piston Pistón Set поршневой	RINGS SET Kolben Set Segments de Piston Anillos Set кольца	PIN Pin Axe Perno Пин			
<b>1.6 CORSA</b> 4 Cyl 79.0 mm Bore Ø 1,598 cc 		Length: Outside Ø: Flange Ø: flange depth	Length: 47.9 Comp: 28.0 Height: -2.7			Top: 1.2 2nd: 1.5 3rd: 3.0 1st oil: 2nd oil:	Ø: 18.0 Length: 55.0				
						Reference no.:		Reference no.:	Reference no.:	Reference no.:	O-RING
								M-S14185	M-E14185		A-R43150 G-0830690000 K-800020740000 M-01108N0 T-50011
NM-Germany Article no. Artikelnummer/ Modelo Número / статья НОМЕР	NM-Germany Article no.	NM-Germany Article no.	NM-Germany Article no.	NM-Germany Article no.	NM-Germany Article no.	NM-Germany Article no.	NM-Germany Article no.				
			KBSOP40520G	KBOP40520G	KROP40520G						

**GASOLINE**

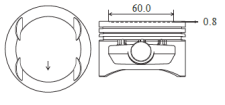

ENGINE TYPE Motortyp Type de Moteur Tipo de motor Тип двигателя	LINER KIT Liner Kit Kit de Chemise Camisas de los cilindros лайнер комплект	CYL. LINER Zylinderlaufbuchse Chemise Camisas de los cilindros втулка цилиндра	PISTON + RINGS Kolben + Ringe Piston + Segments Pistón Set Поршень и кольца			PISTON SET Kolben Set Set de Piston Pistón Set поршневой	RINGS SET Kolben Set Segments de Piston Anillos Set кольца	PIN Pin Axe Perno Пин			
<b>1.2 N</b> <b>1.2 S</b> 4 Cyl 79.0 mm Bore Ø 1,196 cc 		Length: Outside Ø: Flange Ø: flange depth	Length: 76.0 Comp: 38.0 Height: -2.0			Top: 2.0 2nd: 2.0 3rd: 5.0 1st oil: 2nd oil:	Ø: 20.0 Length: 65.0				
						Reference no.:		Reference no.:	Reference no.:	Reference no.:	O-RING
								H-20201 K-92272600 M-0111200			A-R33294K G-0830420000 K-800020840000 M-01112N0
NM-Germany Article no. Artikelnummer/ Modelo Número / статья НОМЕР	NM-Germany Article no.	NM-Germany Article no.	NM-Germany Article no.	NM-Germany Article no.	NM-Germany Article no.	NM-Germany Article no.	NM-Germany Article no.				
			KBSOP40521G	KBOP40521G	KROP40521G						

**GASOLINE**

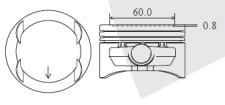

ENGINE TYPE Motortyp Type de Moteur Tipo de motor Тип двигателя	LINER KIT Liner Kit Kit de Chemise Camisas de los cilindros лайнер комплект	CYL. LINER Zylinderlaufbuchse Chemise Camisas de los cilindros втулка цилиндра	PISTON + RINGS Kolben + Ringe Piston + Segments Pistón Set Поршень и кольца		PISTON SET Kolben Set Set de Piston Pistón Set поршневой	RINGS SET Kolben Set Segments de Piston Anillos Set кольца	PIN Pin Axe Perno Пин		
<b>X 1.6 XE</b> <b>X 1.6 XEL</b> 4 Cyl 79.0 mm Bore Ø 1,598 cc		Length:		Length:	STD	O/S	Top: 1.2 2nd: 1.5 3rd: 3.0 1st oil: 2nd oil:	Ø: 18.0 Length: 55.0	
		Outside Ø:		Comp:	51.0	51.0			
		Flange Ø:		Height:	28.0	27.7			
		flange depth			-0.8	-0.8			
		Reference no.:		Reference no.:		Reference no.:		O-RING	
				<b>K-94637600</b>		<b>A-R43150</b> <b>G-0830690000</b> <b>K-800020740000</b> <b>M-01108N0</b> <b>T-50011</b>			
NM-Germany Article no. Artikelnummer/ Modelo Número / статья НОМЕР	NM-Germany Article no.	NM-Germany Article no.	NM-Germany Article no.	NM-Germany Article no.	NM-Germany Article no.	NM-Germany Article no.	NM-Germany Article no.		
			<b>KBSOP40522G</b>	<b>KBOP40522G</b>		<b>KROP40522G</b>			

OPEL

**GASOLINE**

ENGINE TYPE Motortyp Type de Moteur Tipo de motor Тип двигателя	LINER KIT Liner Kit Kit de Chemise Camisas de los cilindros лайнер комплект	CYL. LINER Zylinderlaufbuchse Chemise Camisas de los cilindros втулка цилиндра	PISTON + RINGS Kolben + Ringe Piston + Segments Pistón Set Поршень и кольца		PISTON SET Kolben Set Set de Piston Pistón Set поршневой	RINGS SET Kolben Set Segments de Piston Anillos Set кольца	PIN Pin Axe Perno Пин		
<b>C 1.6 XE</b> <b>X 1.6 XE</b> <b>X 1.6 XEL</b> 4 Cyl 79.0 mm Bore Ø 1,598 cc		Length:		Length:	51.0		Top: 1.2 2nd: 1.5 3rd: 2.5 1st oil: 2nd oil:	Ø: 18.0 Length: 55.0	
		Outside Ø:		Comp:	28.0				
		Flange Ø:		Height:	-0.8				
		flange depth							
		Reference no.:		Reference no.:		Reference no.:		O-RING	
				<b>A-24015</b> <b>M-0116900</b> <b>N-8730780010</b>		<b>A-R48380</b> <b>A-R60570</b> <b>G-0812560000</b> <b>G-0830780000</b> <b>K-800039740000</b> <b>M-01169N0</b>			
NM-Germany Article no. Artikelnummer/ Modelo Número / статья НОМЕР	NM-Germany Article no.	NM-Germany Article no.	NM-Germany Article no.	NM-Germany Article no.	NM-Germany Article no.	NM-Germany Article no.	NM-Germany Article no.		
			<b>KBSOP40523G</b>	<b>KBOP40523G</b>		<b>KROP40523G</b>			

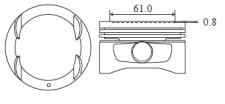
**GASOLINE**

ENGINE TYPE Motortyp Type de Moteur Tipo de motor Тип двигателя	LINER KIT Liner Kit Kit de Chemise Camisas de los cilindros лайнер комплект	CYL. LINER Zylinderlaufbuchse Chemise Camisas de los cilindros втулка цилиндра	PISTON + RINGS Kolben + Ringe Piston + Segments Pistón Set Поршень и кольца		PISTON SET Kolben Set Set de Piston Pistón Set поршневой	RINGS SET Kolben Set Segments de Piston Anillos Set кольца	PIN Pin Axe Perno Пин		
<b>X 1.6 XE</b> <b>X 1.6 XEL</b> 4 Cyl 79.0 mm Bore Ø 1,598 cc		Length:		Length:	47.9		Top: 1.2 2nd: 1.5 3rd: 3.0 1st oil: 2nd oil:	Ø: 18.0 Length: 57.0	
		Outside Ø:		Comp:	27.6				
		Flange Ø:		Height:	-0.8				
		flange depth							
		Reference no.:		Reference no.:		Reference no.:		O-RING	
						<b>A-R43150</b> <b>G-0830690000</b> <b>K-800020740000</b> <b>M-01108N0</b> <b>T-50011</b>			
NM-Germany Article no. Artikelnummer/ Modelo Número / статья НОМЕР	NM-Germany Article no.	NM-Germany Article no.	NM-Germany Article no.	NM-Germany Article no.	NM-Germany Article no.	NM-Germany Article no.	NM-Germany Article no.		
			<b>KBSOP40524G</b>	<b>KBOP40524G</b>		<b>KROP40524G</b>			

**GASOLINE**

ENGINE TYPE Motortyp Type de Moteur Tipo de motor Тип двигателя	LINER KIT Liner Kit Kit de Chemise Camisas de los cilindros лайнер комплект	CYL. LINER Zylinderlaufbuchse Chemise Camisas de los cilindros втулка цилиндра	PISTON + RINGS Kolben + Ringe Piston + Segments Pistón Set Поршень и кольца		PISTON SET Kolben Set Set de Piston Pistón Set поршневой	RINGS SET Kolben Set Segments de Piston Anillos Set кольца	PIN Pin Axe Perno Пин			
<b>Y 1.6 XE</b> <b>Z 1.6 SE</b> <b>Z 1.6 XE</b> 4 Cyl 79.0 mm Bore Ø 1,598 cc		Length: Outside Ø: Flange Ø: flange depth	Length: 50.2 Comp: 27.2 Height: 0			Top: 1.2 2nd: 1.5 3rd: 1st oil: 2.5 2nd oil:	Ø: 18.0 Length: 55.0			
						Reference no.:	Reference no.:	Reference no.:	Reference no.:	O-RING
							<b>A-24146</b> <b>K-40380600</b> <b>M-0121200</b> <b>N-8712560000</b>		<b>A-R48380</b> <b>A-R60570</b> <b>G-0812560000</b> <b>G-0830780000</b> <b>K-800039740000</b> <b>M-01169N0</b>	
NM-Germany Article no. Artikelnummer/ Modelo Número / статья НОМЕР	NM-Germany Article no.	NM-Germany Article no.	NM-Germany Article no.	NM-Germany Article no.	NM-Germany Article no.	NM-Germany Article no.	NM-Germany Article no.			
			KBSOP40525G	KBOP40525G	KROP40525G					

**GASOLINE**



ENGINE TYPE Motortyp Type de Moteur Tipo de motor Тип двигателя	LINER KIT Liner Kit Kit de Chemise Camisas de los cilindros лайнер комплект	CYL. LINER Zylinderlaufbuchse Chemise Camisas de los cilindros втулка цилиндра	PISTON + RINGS Kolben + Ringe Piston + Segments Pistón Set Поршень и кольца		PISTON SET Kolben Set Set de Piston Pistón Set поршневой	RINGS SET Kolben Set Segments de Piston Anillos Set кольца	PIN Pin Axe Perno Пин			
<b>Z 1.6 XEP</b> 4 Cyl 79.0 mm Bore Ø 1,598 cc		Length: Outside Ø: Flange Ø: flange depth	Length: 48.7 Comp: 26.7 Height: 0		skirt MOS2 treated	Top: 1.2 2nd: 1.2 3rd: 1st oil: 2.0 2nd oil:	Ø: 18.0 Length: 52.0			
						Reference no.:	Reference no.:	Reference no.:	Reference no.:	O-RING
							<b>K-40388600</b> <b>M-0122100</b>		<b>K-800072040000</b> <b>M-01221N0</b>	
NM-Germany Article no. Artikelnummer/ Modelo Número / статья НОМЕР	NM-Germany Article no.	NM-Germany Article no.	NM-Germany Article no.	NM-Germany Article no.	NM-Germany Article no.	NM-Germany Article no.	NM-Germany Article no.			
			KBSOP40526G	KBOP40526G	KROP40526G					

**DIESEL**

ENGINE TYPE Motortyp Type de Moteur Tipo de motor Тип двигателя	LINER KIT Liner Kit Kit de Chemise Camisas de los cilindros лайнер комплект	CYL. LINER Zylinderlaufbuchse Chemise Camisas de los cilindros втулка цилиндра	PISTON + RINGS Kolben + Ringe Piston + Segments Pistón Set Поршень и кольца		PISTON SET Kolben Set Set de Piston Pistón Set поршневой	RINGS SET Kolben Set Segments de Piston Anillos Set кольца	PIN Pin Axe Perno Пин			
<b>X 2.5 TD TURBO</b> 6 Cyl 80.0 mm Bore Ø 2,498 cc		Length: 143.0 Outside Ø: 84.0 Flange Ø: 85.0 flange depth 4.8	Length: 62.4 Comp: 39.4 Height: -2.5		alfin and with oil gallery top ring land and skirt MOS2 treated	Top: 3.0 double key- stone 2nd: 1.75 3rd: 1st oil: 3.0 2nd oil:	Ø: 27.0 Length: 63.0			
						Reference no.:	Reference no.:	Reference no.:	Reference no.:	O-RING
							<b>K-94347600</b> <b>M-0826200</b> <b>N-8770450000</b>		<b>A-R49900</b> <b>G-0870450000</b> <b>K-800030120000</b> <b>M-08262N0</b>	
NM-Germany Article no. Artikelnummer/ Modelo Número / статья НОМЕР	NM-Germany Article no.	NM-Germany Article no.	NM-Germany Article no.	NM-Germany Article no.	NM-Germany Article no.	NM-Germany Article no.	NM-Germany Article no.			
	LBSOP60527DSB	LBOP60527DSB	KBSOP60527DB	KBOP60527DB	KROP60527DB					



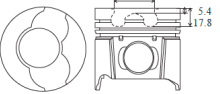

**DIESEL**



ENGINE TYPE Motortyp Type de Moteur Tipo de motor Тип двигателя	LINER KIT Liner Kit Kit de Chemise Camisas de los cilindros лайнер комплект	CYL. LINER Zylinderlaufbuchse Chemise Camisas de los cilindros втулка цилиндра	PISTON + RINGS Kolben + Ringe Piston + Segments Pistón Set Поршень и кольца			PISTON SET Kolben Set Set de Piston Pistón Set поршневой	RINGS SET Kolben Set Segments de Piston Anillos Set кольца	PIN Pin Axe Perno Пин
<b>38.0</b> <b>F9Q 780</b> 4 Cyl 80.0 mm Bore Ø 1,870 cc 		Length: 154.0	Length: 77.4	alfin skirt MOS2 treated fits tapered con. rod			Top: 2.5	Ø: 28.0 Length: 60.0
		Outside Ø: 83.05	Comp: 47.06				2nd: 2.0	
		Flange Ø: 86.0	Height: -5.4				3rd: 3.0	
		flange depth 5.0	-17.8				1st oil: 3.0	
		Reference no.:		Reference no.:	Reference no.:	Reference no.:	O-RING	
				<b>K-99561600</b> <b>M-0215800</b>		<b>A-R60260</b> <b>G-0810150000</b> <b>K-800036140000</b> <b>M-02158V0</b>		
NM-Germany Article no. Artikelnummer/ Modelo Número / статья НОМЕР	NM-Germany Article no.	NM-Germany Article no.	NM-Germany Article no.	NM-Germany Article no.	NM-Germany Article no.	NM-Germany Article no.	NM-Germany Article no.	
	LBSOP40528DSA	LBOP40528DSA	KBSOP40528DA	KBOP40528DA	KROP40528DA			

OPEL

**DIESEL**

ENGINE TYPE Motortyp Type de Moteur Tipo de motor Тип двигателя	LINER KIT Liner Kit Kit de Chemise Camisas de los cilindros лайнер комплект	CYL. LINER Zylinderlaufbuchse Chemise Camisas de los cilindros втулка цилиндра	PISTON + RINGS Kolben + Ringe Piston + Segments Pistón Set Поршень и кольца			PISTON SET Kolben Set Set de Piston Pistón Set поршневой	RINGS SET Kolben Set Segments de Piston Anillos Set кольца	PIN Pin Axe Perno Пин
<b>F8Q 606</b> 4 Cyl 80.0 mm Bore Ø 1,870 cc 		Length: 154.0	Length: 67.4	alfin			Top: 2.0	Ø: 24.0 Length: 63.0
		Outside Ø: 83.05	Comp: 42.5				2nd: 2.0	
		Flange Ø: 86.0	Height: -0.7				3rd: 3.0	
		flange depth 5.0					1st oil: 3.0	
		Reference no.:		Reference no.:	Reference no.:	Reference no.:	O-RING	
				<b>K-92006800</b> <b>M-0219300</b> <b>M-0219310</b>		<b>A-R66330</b> <b>G-0833650000</b> <b>K-800023240000</b> <b>M-02193N0</b>		
NM-Germany Article no. Artikelnummer/ Modelo Número / статья НОМЕР	NM-Germany Article no.	NM-Germany Article no.	NM-Germany Article no.	NM-Germany Article no.	NM-Germany Article no.	NM-Germany Article no.	NM-Germany Article no.	
	LBSOP40529DSA	LBOP40529DSA	KBSOP40529DA	KBOP40529DA	KROP40529DA			

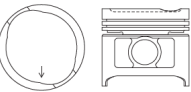
**GASOLINE**

ENGINE TYPE Motortyp Type de Moteur Tipo de motor Тип двигателя	LINER KIT Liner Kit Kit de Chemise Camisas de los cilindros лайнер комплект	CYL. LINER Zylinderlaufbuchse Chemise Camisas de los cilindros втулка цилиндра	PISTON + RINGS Kolben + Ringe Piston + Segments Pistón Set Поршень и кольца			PISTON SET Kolben Set Set de Piston Pistón Set поршневой	RINGS SET Kolben Set Segments de Piston Anillos Set кольца	PIN Pin Axe Perno Пин
<b>1.6 SH</b> 4 Cyl 80.0 mm Bore Ø 1,598 cc 		Length: 72.1	Length: 72.1				Top: 1.5	Ø: 23.0 Length: 70.0
		Outside Ø: 86.0	Comp: 40.0				2nd: 1.75	
		Flange Ø: 86.0	Height: -3.1				3rd: 4.0	
		flange depth					1st oil: 4.0	
		Reference no.:		Reference no.:	Reference no.:	Reference no.:	O-RING	
				<b>H-21262</b> <b>K-93637700</b> <b>M-0115600</b> <b>N-8730560710</b>	<b>901 065 33</b> <b>901 405 21</b>	<b>A-R35930</b> <b>G-0830560000</b> <b>K-800020940000</b> <b>M-01156N0</b>		
NM-Germany Article no. Artikelnummer/ Modelo Número / статья НОМЕР	NM-Germany Article no.	NM-Germany Article no.	NM-Germany Article no.	NM-Germany Article no.	NM-Germany Article no.	NM-Germany Article no.	NM-Germany Article no.	
			KBSOP40530G	KBOP40530G	KROP40530G			

**GASOLINE**

ENGINE TYPE Motortyp Type de Moteur Tipo de motor Тип двигателя	LINER KIT Liner Kit Kit de Chemise Camisas de los cilindros лайнер комплект	CYL. LINER Zylinderlaufbuchse Chemise Camisas de los cilindros втулка цилиндра	PISTON + RINGS Kolben + Ringe Piston + Segments Pistón Set Поршень и кольца		PISTON SET Kolben Set Set de Piston Pistón Set поршень	RINGS SET Kolben Set Segments de Piston Anillos Set кольца	PIN Pin Axe Perno Пин	
<b>X 18 XE1</b> <b>Z 18 XE</b> <b>Z 18 XEL</b> 4 Cyl 80.5 mm Bore Ø 1,796 cc		Length: Outside Ø: Flange Ø: flange depth	Length:	44.7	skirt MOS2 treated	Top:	1.2	Ø: 18.0 Length: 55.0
			Comp:	24.1		2nd:	1.2	
			Height:	0		3rd:	2.0	
			Reference no.:	Reference no.:	Reference no.:	Reference no.:	O-RING	
				<b>K-99741601</b> <b>M-0120200</b>		<b>G-0814120000</b> <b>K-800038940000</b> <b>M-01202N0</b>		
NM-Germany Article no. Artikelnummer/ Modelo Número / статья НОМЕР	NM-Germany Article no.	NM-Germany Article no.	NM-Germany Article no.	NM-Germany Article no.	NM-Germany Article no.	NM-Germany Article no.	NM-Germany Article no.	
			<b>KBSOP40531G</b>	<b>KBOP40531G</b>	<b>KROP40531G</b>			



**GASOLINE**

ENGINE TYPE Motortyp Type de Moteur Tipo de motor Тип двигателя	LINER KIT Liner Kit Kit de Chemise Camisas de los cilindros лайнер комплект	CYL. LINER Zylinderlaufbuchse Chemise Camisas de los cilindros втулка цилиндра	PISTON + RINGS Kolben + Ringe Piston + Segments Pistón Set Поршень и кольца		PISTON SET Kolben Set Set de Piston Pistón Set поршень	RINGS SET Kolben Set Segments de Piston Anillos Set кольца	PIN Pin Axe Perno Пин		
<b>C 1.8 XE</b> <b>C 1.8 XEL</b> <b>X 1.8 XE</b> 4 Cyl 81.6 mm Bore Ø 1,796 cc		Length: Outside Ø: Flange Ø: flange depth		STD O/S	skirt MOS2 treated	Top:	1.5	Ø: 21.0 Length: 61.5	
			Length:	50.4		50.1	2nd:		1.5
			Comp:	30.4		30.1	3rd:		3.0
			Height:	-1.8	-1.8	1st oil:	3.0		
			Reference no.:	Reference no.:	Reference no.:	Reference no.:	O-RING		
				<b>H-24088</b> <b>K-99438600</b> <b>M-0117000</b> <b>N-8730770010</b>	<b>904 865 78</b>	<b>A-R49600</b> <b>G-0830770000</b> <b>K-800040320000</b> <b>K-800040340000</b> <b>M-01170N0</b>			
NM-Germany Article no. Artikelnummer/ Modelo Número / статья НОМЕР	NM-Germany Article no.	NM-Germany Article no.	NM-Germany Article no.	NM-Germany Article no.	NM-Germany Article no.	NM-Germany Article no.	NM-Germany Article no.		
			<b>KBSOP40532G</b>	<b>KBOP40532G</b>	<b>KROP40532G</b>				

**GASOLINE**

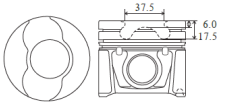

ENGINE TYPE Motortyp Type de Moteur Tipo de motor Тип двигателя	LINER KIT Liner Kit Kit de Chemise Camisas de los cilindros лайнер комплект	CYL. LINER Zylinderlaufbuchse Chemise Camisas de los cilindros втулка цилиндра	PISTON + RINGS Kolben + Ringe Piston + Segments Pistón Set Поршень и кольца		PISTON SET Kolben Set Set de Piston Pistón Set поршень	RINGS SET Kolben Set Segments de Piston Anillos Set кольца	PIN Pin Axe Perno Пин	
<b>C 25 LET/NE</b> <b>C 25 XE</b> <b>X 25 XE</b> 6 Cyl 81.6 mm Bore Ø 2,498 cc		Length: Outside Ø: Flange Ø: flange depth	Length:	51.08		Top:	1.5	Ø: 21.0 Length: 56.0
			Comp:	30.45		2nd:	1.5	
			Height:	0.6		3rd:	3.0	
			Reference no.:	Reference no.:	Reference no.:	Reference no.:	O-RING	
				<b>A-24090</b> <b>K-94954600</b> <b>M-0120600</b> <b>N-8730770000</b>	<b>904 668 89</b>	<b>A-R49600</b> <b>G-0830770000</b> <b>K-800040320000</b> <b>K-800040340000</b> <b>M-01170N0</b>		
NM-Germany Article no. Artikelnummer/ Modelo Número / статья НОМЕР	NM-Germany Article no.	NM-Germany Article no.	NM-Germany Article no.	NM-Germany Article no.	NM-Germany Article no.	NM-Germany Article no.	NM-Germany Article no.	
			<b>KBSOP60533G</b>	<b>KBOP60533G</b>	<b>KROP60533G</b>			

**DIESEL**

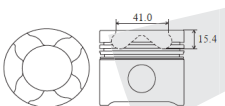

ENGINE TYPE Motortyp Type de Moteur Tipo de motor Тип двигателя	LINER KIT Liner Kit Kit de Chemise Camisas de los cilindros лайнер комплект	CYL. LINER Zylinderlaufbuchse Chemise Camisas de los cilindros втулка цилиндра	PISTON + RINGS Kolben + Ringe Piston + Segments Pistón Set Поршень и кольца	PISTON SET Kolben Set Set de Piston Pistón Set поршневой	RINGS SET Kolben Set Segments de Piston Anillos Set кольца	PIN Pin Axe Perno Пин
<b>Z 19 DT</b> <b>Z 19 DTL</b> 4 Cyl 82.0 mm Bore Ø 1,910 cc 		Length: 155.0 Outside Ø: 85.0 Flange Ø: 88.0 flange depth 4.5	Length: 72.5 Comp: 46.5 Height: -6.0 -17.5	alfin skirt MOS2 treated pin bushing inserted	Top: 2.0 2nd: 2.0 3rd: 2.0 1st oil: 2.0 2nd oil:	Ø: 25.988 Length: 61.0
		<b>Reference no.:</b>	<b>Reference no.:</b>	<b>Reference no.:</b>	<b>Reference no.:</b>	<b>O-RING</b>
		<b>G-1402896000</b>	<b>A-A354067</b> <b>K-40218600</b> <b>K-99724600</b> <b>M-0101500</b> <b>N-8712400030</b>	<b>562 322 1</b> <b>562 322 2</b> <b>931 783 75</b> <b>931 783 76</b>	<b>A-R60580</b> <b>A-R67925</b> <b>G-0812400000</b> <b>G-0814610000</b> <b>K-800072610000</b> <b>K-800073040000</b> <b>M-00981N0</b>	
NM-Germany Article no. Artikelnummer/ Modelo Número / статья НОМЕР	NM-Germany Article no.	NM-Germany Article no.	NM-Germany Article no.	NM-Germany Article no.	NM-Germany Article no.	NM-Germany Article no.
	LBSOP40534DSA	LBOP40534DSA	KBSOP40534DA	KBOP40534DA	KROP40534DA	

OPEL

**DIESEL**

ENGINE TYPE Motortyp Type de Moteur Tipo de motor Тип двигателя	LINER KIT Liner Kit Kit de Chemise Camisas de los cilindros лайнер комплект	CYL. LINER Zylinderlaufbuchse Chemise Camisas de los cilindros втулка цилиндра	PISTON + RINGS Kolben + Ringe Piston + Segments Pistón Set Поршень и кольца	PISTON SET Kolben Set Set de Piston Pistón Set поршневой	RINGS SET Kolben Set Segments de Piston Anillos Set кольца	PIN Pin Axe Perno Пин
<b>Z 19 DTH</b> <b>Z 19 DTJ</b> 4 Cyl 82.0 mm Bore Ø 1,910 cc 		Length: 155.0 Outside Ø: 85.0 Flange Ø: 88.0 flange depth 4.5	Length: 73.5 Comp: 46.5 Height: -0.7 -15.4	alfin and with oil gallery skirt MOS2 treated pin bushing inserted	Top: 2.0 2nd: 2.0 3rd: 2.0 1st oil: 2.0 2nd oil:	Ø: 26.0 Length: 61.0
		<b>Reference no.:</b>	<b>Reference no.:</b>	<b>Reference no.:</b>	<b>Reference no.:</b>	<b>O-RING</b>
		<b>G-1402896000</b>	<b>A-A354086</b> <b>K-40660600</b> <b>M-0101600</b> <b>N-8714610000</b>		<b>A-R60580</b> <b>A-R67925</b> <b>G-0812400000</b> <b>G-0814610000</b> <b>K-800072610000</b> <b>K-800073040000</b> <b>M-00981N0</b>	
NM-Germany Article no. Artikelnummer/ Modelo Número / статья НОМЕР	NM-Germany Article no.	NM-Germany Article no.	NM-Germany Article no.	NM-Germany Article no.	NM-Germany Article no.	NM-Germany Article no.
	LBSOP40535DSB	LBOP40535DSB	KBSOP40535DB	KBOP40535DB	KROP40535DB	

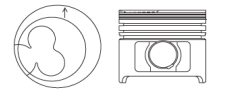
**DIESEL**

ENGINE TYPE Motortyp Type de Moteur Tipo de motor Тип двигателя	LINER KIT Liner Kit Kit de Chemise Camisas de los cilindros лайнер комплект	CYL. LINER Zylinderlaufbuchse Chemise Camisas de los cilindros втулка цилиндра	PISTON + RINGS Kolben + Ringe Piston + Segments Pistón Set Поршень и кольца	PISTON SET Kolben Set Set de Piston Pistón Set поршневой	RINGS SET Kolben Set Segments de Piston Anillos Set кольца	PIN Pin Axe Perno Пин
<b>17 D</b> <b>17 DR/17 YD</b> <b>X 17 DTL</b> 4 Cyl 82.5 mm Bore Ø 1,699 cc 	<b>K-90858960</b> <b>M-0112990</b>	Length: 143.5 Outside Ø: 85.5 Flange Ø: 87.4 flange depth 4.5	Length: 72.95 Comp: 44.95 Height: -2.6	alfin head anodized	Top: 2.0 2nd: 2.0 3rd: 3.0 1st oil: 3.0 2nd oil:	Ø: 26.0 Length: 65.0
		<b>Reference no.:</b>	<b>Reference no.:</b>	<b>Reference no.:</b>	<b>Reference no.:</b>	<b>O-RING</b>
		<b>H-SU351376</b> <b>K-89432190</b> <b>M-011VV05</b>	<b>A-A350492</b> <b>K-90858600</b> <b>M-0112900</b>	<b>902 859 82</b> <b>903 495 80</b> <b>903 495 91</b> <b>903 495 92</b> <b>903 497 79</b> <b>903 497 90</b> <b>903 497 91</b>	<b>903 220 67</b> <b>903 220 71</b> <b>903 220 75</b> <b>A-R43380</b> <b>A-R48750</b> <b>G-0830670000</b> <b>K-800021040000</b> <b>M-01129N0</b>	
NM-Germany Article no. Artikelnummer/ Modelo Número / статья НОМЕР	NM-Germany Article no.	NM-Germany Article no.	NM-Germany Article no.	NM-Germany Article no.	NM-Germany Article no.	NM-Germany Article no.
	LBSOP40536DSA	LBOP40536DSA	KBSOP40536DA	KBOP40536DA	KROP40536DA	

**GASOLINE**

ENGINE TYPE Motortyp Type de Moteur Tipo de motor Тип двигателя	LINER KIT Liner Kit Kit de Chemise Camisas de los cilindros лайнер комплект	CYL. LINER Zylinderlaufbuchse Chemise Camisas de los cilindros втулка цилиндра	PISTON + RINGS Kolben + Ringe Piston + Segments Pistón Set Поршень и кольца	PISTON SET Kolben Set Set de Piston Pistón Set поршневой	RINGS SET Kolben Set Segments de Piston Anillos Set кольца	PIN Pin Axe Perno Пин
<b>F4R 720</b> 4 Cyl 82.7 mm Bore Ø 1,998 cc		Length: 56.75 Outside Ø: 30.25 Flange Ø: -2.6 flange depth			Top: 1.2 2nd: 1.5 3rd: 2.0 1st oil: 2.0 2nd oil:	Ø: 21.0 Length: 61.0
			Reference no.: <b>K-40355600</b>	Reference no.:	Reference no.: <b>K-800074510000</b> <b>M-02210N0</b>	O-RING
NM-Germany Article no. Artikelnummer/ Modelo Número / статья НОМЕР	NM-Germany Article no.	NM-Germany Article no.	NM-Germany Article no.	NM-Germany Article no.	NM-Germany Article no.	NM-Germany Article no.
			<b>KBSOP40537G</b>	<b>KBOP40537G</b>	<b>KROP40537G</b>	

**DIESEL**

ENGINE TYPE Motortyp Type de Moteur Tipo de motor Тип двигателя	LINER KIT Liner Kit Kit de Chemise Camisas de los cilindros лайнер комплект	CYL. LINER Zylinderlaufbuchse Chemise Camisas de los cilindros втулка цилиндра	PISTON + RINGS Kolben + Ringe Piston + Segments Pistón Set Поршень и кольца	PISTON SET Kolben Set Set de Piston Pistón Set поршневой	RINGS SET Kolben Set Segments de Piston Anillos Set кольца	PIN Pin Axe Perno Пин
<b>X 20 DTL</b> <b>Y 20 DTL</b> 4 Cyl 84.0 mm Bore Ø 1,995 cc		Length: 160.0 Outside Ø: 87.0 Flange Ø: 90.0 flange depth 4.5	Length: 70.8 Comp: 45.8 Height: -8.1 -14.9	alfin skirt MOS2 treated fits tapered con. rod	Top: 2.0 2nd: 1.75 3rd: 3.0 1st oil: 2nd oil:	Ø: 29.0 Length: 68.0
			Reference no.: <b>A-SU351508</b> <b>G-1410280000</b>	Reference no.: <b>A-A350508</b> <b>K-94834700</b> <b>M-0117200</b> <b>M-0120700</b> <b>N-8710280010</b>	Reference no.: <b>A-R49830</b> <b>G-08102080000</b> <b>M-01207N0</b>	O-RING
NM-Germany Article no. Artikelnummer/ Modelo Número / статья НОМЕР	NM-Germany Article no.	NM-Germany Article no.	NM-Germany Article no.	NM-Germany Article no.	NM-Germany Article no.	NM-Germany Article no.
	<b>LBSOP40538DSA</b>	<b>LBOP40538DSA</b>	<b>KBSOP40538DA</b>	<b>KBOP40538DA</b>	<b>KROP40538DA</b>	

**DIESEL**

ENGINE TYPE Motortyp Type de Moteur Tipo de motor Тип двигателя	LINER KIT Liner Kit Kit de Chemise Camisas de los cilindros лайнер комплект	CYL. LINER Zylinderlaufbuchse Chemise Camisas de los cilindros втулка цилиндра	PISTON + RINGS Kolben + Ringe Piston + Segments Pistón Set Поршень и кольца	PISTON SET Kolben Set Set de Piston Pistón Set поршневой	RINGS SET Kolben Set Segments de Piston Anillos Set кольца	PIN Pin Axe Perno Пин
<b>X 20 DTH</b> 4 Cyl 84.0 mm Bore Ø 1,995 cc		Length: 160.0 Outside Ø: 87.0 Flange Ø: 90.0 flange depth 4.5	Length: 70.8 Comp: 45.8 Height: -6.3 -14.6	alfin skirt MOS2 treated fits tapered con. rod	Top: 2.5 double key- stone 2nd: 1.75 3rd: 3.0 1st oil: 2nd oil:	Ø: 29.0 Length: 68.0
			Reference no.: <b>A-SU351508</b> <b>G-1410280000</b>	Reference no.: <b>A-A350517</b> <b>K-99421600</b> <b>N-8710290010</b>	Reference no.: <b>A-R49840</b> <b>G-08102900000</b> <b>K-800036040000</b>	O-RING
NM-Germany Article no. Artikelnummer/ Modelo Número / статья НОМЕР	NM-Germany Article no.	NM-Germany Article no.	NM-Germany Article no.	NM-Germany Article no.	NM-Germany Article no.	NM-Germany Article no.
	<b>LBSOP40539DSA</b>	<b>LBOP40539DSA</b>	<b>KBSOP40539DA</b>	<b>KBOP40539DA</b>	<b>KROP40539DA</b>	

**DIESEL**

ENGINE TYPE Motortyp Type de Moteur Tipo de motor Тип двигателя	LINER KIT Liner Kit Kit de Chemise Camisas de los cilindros лайнер комплект	CYL. LINER Zylinderlaufbuchse Chemise Camisas de los cilindros втулка цилиндра	PISTON + RINGS Kolben + Ringe Piston + Segments Pistón Set Поршень и кольца		PISTON SET Kolben Set Set de Piston Pistón Set поршневой	RINGS SET Kolben Set Segments de Piston Anillos Set кольца	PIN Pin Axe Perno Пин					
<b>X 22 DTH</b> 4 Cyl 84.0 mm Bore Ø 2,172 cc		Length: Outside Ø: Flange Ø: flange depth	Length: 70.8 Comp: 45.8 Height: -14.53	alfin skirt MOS2 treated fits tapered con. rod	Top: 2.5 2nd: 1.75 3rd: 3.0 1st oil: 2nd oil:	Ø: 29.0 Length: 68.0						
								Reference no.:	Reference no.:	Reference no.:	Reference no.:	O-RING
									<b>M-0120300</b>		<b>M-01203N0</b>	
NM-Germany Article no. Artikelnummer/ Modelo Número / статья НОМЕР	NM-Germany Article no.	NM-Germany Article no.	NM-Germany Article no.	NM-Germany Article no.	NM-Germany Article no.	NM-Germany Article no.	NM-Germany Article no.					
			<b>KBSOP40540DA</b>	<b>KBOP40540DA</b>	<b>KROP40540DA</b>							

OPEL

**DIESEL**

ENGINE TYPE Motortyp Type de Moteur Tipo de motor Тип двигателя	LINER KIT Liner Kit Kit de Chemise Camisas de los cilindros лайнер комплект	CYL. LINER Zylinderlaufbuchse Chemise Camisas de los cilindros втулка цилиндра	PISTON + RINGS Kolben + Ringe Piston + Segments Pistón Set Поршень и кольца		PISTON SET Kolben Set Set de Piston Pistón Set поршневой	RINGS SET Kolben Set Segments de Piston Anillos Set кольца	PIN Pin Axe Perno Пин					
<b>Y 20 DTH</b> 4 Cyl 84.0 mm Bore Ø 1,998 cc		Length: Outside Ø: Flange Ø: flange depth	Length: 70.8 Comp: 45.85 Height: -14.68	alfin and with oil gallery skirt MOS2 treated fits tapered con. rod	Top: 1.75 2nd: 1.75 3rd: 3.0 1st oil: 2nd oil:	Ø: 29.0 Length: 68.0						
								Reference no.:	Reference no.:	Reference no.:	Reference no.:	O-RING
									<b>A-350599</b> <b>M-0121400</b> <b>N-8712600000</b>		<b>A-R60610</b> <b>G-0812600000</b> <b>M-01208N0</b>	
NM-Germany Article no. Artikelnummer/ Modelo Número / статья НОМЕР	NM-Germany Article no.	NM-Germany Article no.	NM-Germany Article no.	NM-Germany Article no.	NM-Germany Article no.	NM-Germany Article no.	NM-Germany Article no.					
			<b>KBSOP40541DB</b>	<b>KBOP40541DB</b>	<b>KROP40541DB</b>							

**DIESEL**

ENGINE TYPE Motortyp Type de Moteur Tipo de motor Тип двигателя	LINER KIT Liner Kit Kit de Chemise Camisas de los cilindros лайнер комплект	CYL. LINER Zylinderlaufbuchse Chemise Camisas de los cilindros втулка цилиндра	PISTON + RINGS Kolben + Ringe Piston + Segments Pistón Set Поршень и кольца		PISTON SET Kolben Set Set de Piston Pistón Set поршневой	RINGS SET Kolben Set Segments de Piston Anillos Set кольца	PIN Pin Axe Perno Пин					
<b>X 22 DTH</b> <b>Y 22 DTH</b> <b>Y 22 DTR</b> 4 Cyl 84.0 mm Bore Ø 2,172 cc		Length: Outside Ø: Flange Ø: flange depth	Length: 70.8 Comp: 45.85 Height: -8.0	alfin and with oil gallery skirt MOS2 treated fits tapered con. rod	Top: 1.75 2nd: 1.75 3rd: 3.0 1st oil: 2nd oil:	Ø: 29.0 Length: 68.0						
								Reference no.:	Reference no.:	Reference no.:	Reference no.:	O-RING
									<b>A-A350600</b> <b>M-0120900</b> <b>N-8712600010</b>		<b>A-R60610</b> <b>G-0812600000</b> <b>M-01208N0</b>	
NM-Germany Article no. Artikelnummer/ Modelo Número / статья НОМЕР	NM-Germany Article no.	NM-Germany Article no.	NM-Germany Article no.	NM-Germany Article no.	NM-Germany Article no.	NM-Germany Article no.	NM-Germany Article no.					
			<b>KBSOP40542DB</b>	<b>KBOP40542DB</b>	<b>KROP40542DB</b>							

**DIESEL**

ENGINE TYPE Motortyp Type de Moteur Tipo de motor Тип двигателя	LINER KIT Liner Kit Kit de Chemise Camisas de los cilindros лайнер комплект	CYL. LINER Zylinderlaufbuchse Chemise Camisas de los cilindros втулка цилиндра	PISTON + RINGS Kolben + Ringe Piston + Segments Pistón Set Поршень и кольца			PISTON SET Kolben Set Set de Piston Pistón Set поршень	RINGS SET Kolben Set Segments de Piston Anillos Set кольца	PIN Pin Axe Perno Пин			
<b>Y 20 DTH</b> <b>Y 20 DTL</b> 4 Cyl 84.0 mm Bore Ø 1,998 cc		Length: Outside Ø: Flange Ø: flange depth	Length: 70.8 Comp: 45.8 Height: -7.7 -14.9		alfin and with oil gallery skirt MOS2 treated fits tapered con. rod	Top: 1.75 2nd: 1.75 3rd: 3.0 1st oil: 3.0 2nd oil:	Ø: 29.0 Length: 68.0				
						Reference no.:		Reference no.:	Reference no.:	Reference no.:	O-RING
								<b>M-0120800</b>		<b>A-R60610</b> <b>G-0812600000</b> <b>M-01208N0</b>	
NM-Germany Article no. Artikelnummer/ Modelo Número / статья НОМЕР	NM-Germany Article no.	NM-Germany Article no.	NM-Germany Article no.	NM-Germany Article no.	NM-Germany Article no.	NM-Germany Article no.	NM-Germany Article no.				
			<b>KBSOP40543DB</b>	<b>KBOP40543DB</b>	<b>KROP40543DB</b>						

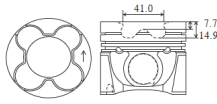
**DIESEL**

ENGINE TYPE Motortyp Type de Moteur Tipo de motor Тип двигателя	LINER KIT Liner Kit Kit de Chemise Camisas de los cilindros лайнер комплект	CYL. LINER Zylinderlaufbuchse Chemise Camisas de los cilindros втулка цилиндра	PISTON + RINGS Kolben + Ringe Piston + Segments Pistón Set Поршень и кольца			PISTON SET Kolben Set Set de Piston Pistón Set поршень	RINGS SET Kolben Set Segments de Piston Anillos Set кольца	PIN Pin Axe Perno Пин			
<b>Y 22 DTH</b> 4 Cyl 84.0 mm Bore Ø 2,171 cc		Length: Outside Ø: Flange Ø: flange depth	Length: 70.8 Comp: 45.8 Height: -6.0 -14.53		alfin and with oil gallery skirt MOS2 treated	Top: 1.75 2nd: 1.75 3rd: 3.0 1st oil: 3.0 2nd oil:	Ø: 29.0 Length: 68.0				
						Reference no.:		Reference no.:	Reference no.:	Reference no.:	O-RING
								<b>M-0121700</b>		<b>A-R60610</b> <b>G-0812600000</b> <b>M-01208N0</b>	
NM-Germany Article no. Artikelnummer/ Modelo Número / статья НОМЕР	NM-Germany Article no.	NM-Germany Article no.	NM-Germany Article no.	NM-Germany Article no.	NM-Germany Article no.	NM-Germany Article no.	NM-Germany Article no.				
			<b>KBSOP40544DB</b>	<b>KBOP40544DB</b>	<b>KROP40544DB</b>						

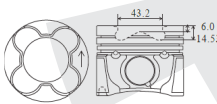
**DIESEL**

ENGINE TYPE Motortyp Type de Moteur Tipo de motor Тип двигателя	LINER KIT Liner Kit Kit de Chemise Camisas de los cilindros лайнер комплект	CYL. LINER Zylinderlaufbuchse Chemise Camisas de los cilindros втулка цилиндра	PISTON + RINGS Kolben + Ringe Piston + Segments Pistón Set Поршень и кольца			PISTON SET Kolben Set Set de Piston Pistón Set поршень	RINGS SET Kolben Set Segments de Piston Anillos Set кольца	PIN Pin Axe Perno Пин			
<b>M9R 780</b> 4 Cyl 84.0 mm Bore Ø 1,995 cc	<b>K-40262600</b> <b>N-8742200000</b> <b>G-0842200000</b> <b>K-800057140000</b>	Length: 169.5 Outside Ø: 88.0 Flange Ø: 91.0 flange depth 5.0	Length: 76.0 Comp: 47.92 Height: -5.3 -14.9		alfin and with oil gallery skirt MOS2 treated fits tapered con. rod	Top: 2.5 half keystone 2nd: 2.0 3rd: 2.0 1st oil: 2.0 2nd oil:	Ø: 32.0 Length: 65.0				
						Reference no.:		Reference no.:	Reference no.:	Reference no.:	O-RING
NM-Germany Article no. Artikelnummer/ Modelo Número / статья НОМЕР	NM-Germany Article no.	NM-Germany Article no.	NM-Germany Article no.	NM-Germany Article no.	NM-Germany Article no.	NM-Germany Article no.	NM-Germany Article no.				
	<b>LBSOP40545DSB</b>	<b>LBOP40545DSB</b>	<b>KBSOP40545DB</b>	<b>KBOP40545DB</b>	<b>KROP40545DB</b>						

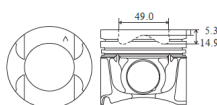

**GASOLINE**

ENGINE TYPE Motortyp Type de Moteur Tipo de motor Тип двигателя	LINER KIT Liner Kit Kit de Chemise Camisas de los cilindros лайнер комплект	CYL. LINER Zylinderlaufbuchse Chemise Camisas de los cilindros втулка цилиндра	PISTON + RINGS Kolben + Ringe Piston + Segments Pistón Set Поршень и кольца			PISTON SET Kolben Set Set de Piston Pistón Set поршневой	RINGS SET Kolben Set Segments de Piston Anillos Set кольца	PIN Pin Axe Perno Пин			
<b>1.8 E</b> <b>1.8 SEH</b> <b>1.8 SV</b> 4 Cyl 84.8 mm Bore Ø 1,796 cc		Length: Outside Ø: Flange Ø: flange depth	Length: Comp: Height:			Top: 1.5 2nd: 1.5 3rd: 1.5 1st oil: 3.0 2nd oil:	Ø: 21.0 Length: 61.5				
						Reference no.:		Reference no.:	Reference no.:	Reference no.:	O-RING
								<b>H-23379</b> <b>K-90252600</b> <b>M-0116300</b>	<b>902 653 09</b> <b>902 712 93</b> <b>902 712 94</b> <b>902 712 95</b> <b>902 712 96</b> <b>902 712 97</b> <b>902 713 06</b> <b>903 549 75</b> <b>904 104 15</b>	<b>A-R43260</b> <b>G-0830720000</b> <b>K-800021140000</b> <b>M-01163N0</b> <b>T-50010</b>	
NM-Germany Article no. Artikelnummer/ Modelo Número / статья НОМЕР	NM-Germany Article no.	NM-Germany Article no.	NM-Germany Article no.	NM-Germany Article no.	NM-Germany Article no.	NM-Germany Article no.	NM-Germany Article no.				
			KBSOP40546G	KBOP40546G	KROP40546G						

OPEL



**GASOLINE**

ENGINE TYPE Motortyp Type de Moteur Tipo de motor Тип двигателя	LINER KIT Liner Kit Kit de Chemise Camisas de los cilindros лайнер комплект	CYL. LINER Zylinderlaufbuchse Chemise Camisas de los cilindros втулка цилиндра	PISTON + RINGS Kolben + Ringe Piston + Segments Pistón Set Поршень и кольца			PISTON SET Kolben Set Set de Piston Pistón Set поршневой	RINGS SET Kolben Set Segments de Piston Anillos Set кольца	PIN Pin Axe Perno Пин			
<b>1.8 E</b> 4 Cyl 84.8 mm Bore Ø 1,796 cc		Length: Outside Ø: Flange Ø: flange depth	Length: Comp: Height:			Top: 1.5 2nd: 1.75 3rd: 1.75 1st oil: 4.0 2nd oil:	Ø: 23.0 Length: 70.0				
						Reference no.:		Reference no.:	Reference no.:	Reference no.:	O-RING
										<b>A-R39880</b> <b>G-0830600000</b> <b>M-01166N0</b>	
NM-Germany Article no. Artikelnummer/ Modelo Número / статья НОМЕР	NM-Germany Article no.	NM-Germany Article no.	NM-Germany Article no.	NM-Germany Article no.	NM-Germany Article no.	NM-Germany Article no.	NM-Germany Article no.				
			KBSOP40547G	KBOP40547G	KROP40547G						



**GASOLINE**

ENGINE TYPE Motortyp Type de Moteur Tipo de motor Тип двигателя	LINER KIT Liner Kit Kit de Chemise Camisas de los cilindros лайнер комплект	CYL. LINER Zylinderlaufbuchse Chemise Camisas de los cilindros втулка цилиндра	PISTON + RINGS Kolben + Ringe Piston + Segments Pistón Set Поршень и кольца			PISTON SET Kolben Set Set de Piston Pistón Set поршневой	RINGS SET Kolben Set Segments de Piston Anillos Set кольца	PIN Pin Axe Perno Пин			
<b>1.8 S</b> 4 Cyl 84.8 mm Bore Ø 1,796 cc		Length: Outside Ø: Flange Ø: flange depth	Length: Comp: Height:			Top: 1.5 2nd: 1.75 3rd: 1.75 1st oil: 4.0 2nd oil:	Ø: 23.0 Length: 70.0				
						Reference no.:		Reference no.:	Reference no.:	Reference no.:	O-RING
								<b>H-21295</b> <b>K-93890600</b> <b>M-0116500</b>	<b>901 671 49</b> <b>901 671 50</b> <b>901 671 51</b> <b>901 671 52</b> <b>901 671 53</b> <b>901 671 54</b> <b>901 671 55</b> <b>901 671 56</b> <b>901 671 57</b> <b>901 671 58</b> <b>901 671 59</b> <b>901 671 60</b> <b>901 671 61</b> <b>901 671 62-65</b>	<b>A-R39880</b> <b>G-0830600000</b> <b>M-01166N0</b>	
NM-Germany Article no. Artikelnummer/ Modelo Número / статья НОМЕР	NM-Germany Article no.	NM-Germany Article no.	NM-Germany Article no.	NM-Germany Article no.	NM-Germany Article no.	NM-Germany Article no.	NM-Germany Article no.				
			KBSOP40548G	KBOP40548G	KROP40548G						

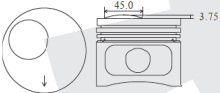

**GASOLINE**

ENGINE TYPE Motortyp Type de Moteur Tipo de motor Тип двигателя	LINER KIT Liner Kit Kit de Chemise Camisas de los cilindros лайнер комплект	CYL. LINER Zylinderlaufbuchse Chemise Camisas de los cilindros втулка цилиндра	PISTON + RINGS Kolben + Ringe Piston + Segments Pistón Set Поршень и кольца		PISTON SET Kolben Set Set de Piston Pistón Set поршневой	RINGS SET Kolben Set Segments de Piston Anillos Set кольца	PIN Pin Axe Perno Пин
<b>1.8 N</b> <b>1.8 NH</b> 4 Cyl 84.8 mm Bore Ø 1,795 cc 		Length: Outside Ø: Flange Ø: flange depth	Length:	STD	O/S	Top: 1.5 2nd: 1.75 3rd: 1st oil: 4.0 2nd oil:	Ø: 23.0 Length: 70.0
			Length:	72.0	71.7		
			Comp:	40.0	39.7		
		Height:	-5.0	-5.0			
		Reference no.:	Reference no.:	Reference no.:	Reference no.:	O-RING	
			<b>K-93889600</b> <b>M-0116600</b>		<b>A-R39880</b> <b>G-0830600000</b> <b>M-01166N0</b>		
NM-Germany Article no. Artikelnummer/ Modelo Número / статья НОМЕР	NM-Germany Article no.	NM-Germany Article no.	NM-Germany Article no.	NM-Germany Article no.	NM-Germany Article no.	NM-Germany Article no.	
			<b>KBSOP40549G</b>	<b>KBOP40549G</b>	<b>KROP40549G</b>		

**GASOLINE**

ENGINE TYPE Motortyp Type de Moteur Tipo de motor Тип двигателя	LINER KIT Liner Kit Kit de Chemise Camisas de los cilindros лайнер комплект	CYL. LINER Zylinderlaufbuchse Chemise Camisas de los cilindros втулка цилиндра	PISTON + RINGS Kolben + Ringe Piston + Segments Pistón Set Поршень и кольца		PISTON SET Kolben Set Set de Piston Pistón Set поршневой	RINGS SET Kolben Set Segments de Piston Anillos Set кольца	PIN Pin Axe Perno Пин
<b>GM 1.8 YVH</b> 4 Cyl 84.8 mm Bore Ø 1,796 cc 		Length: Outside Ø: Flange Ø: flange depth	Length:	57.15		Top: 1.5 2nd: 1.5 3rd: 1st oil: 3.0 2nd oil:	Ø: 21.0 Length: 61.5
			Length:	33.65			
			Comp:	33.65			
		Height:	3.75				
		Reference no.:	Reference no.:	Reference no.:	Reference no.:	O-RING	
			<b>M-S14230</b>	<b>M-E14230</b>	<b>A-R43260</b> <b>G-0830720000</b> <b>K-800021140000</b> <b>M-01163N0</b> <b>T-50010</b>		
NM-Germany Article no. Artikelnummer/ Modelo Número / статья НОМЕР	NM-Germany Article no.	NM-Germany Article no.	NM-Germany Article no.	NM-Germany Article no.	NM-Germany Article no.	NM-Germany Article no.	
			<b>KBSOP40550G</b>	<b>KBOP40550G</b>	<b>KROP40550G</b>		

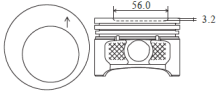
**GASOLINE**

ENGINE TYPE Motortyp Type de Moteur Tipo de motor Тип двигателя	LINER KIT Liner Kit Kit de Chemise Camisas de los cilindros лайнер комплект	CYL. LINER Zylinderlaufbuchse Chemise Camisas de los cilindros втулка цилиндра	PISTON + RINGS Kolben + Ringe Piston + Segments Pistón Set Поршень и кольца		PISTON SET Kolben Set Set de Piston Pistón Set поршневой	RINGS SET Kolben Set Segments de Piston Anillos Set кольца	PIN Pin Axe Perno Пин
<b>1.8 NE</b> 4 Cyl 84.8 mm Bore Ø 1,796 cc 		Length: Outside Ø: Flange Ø: flange depth	Length:	58.2		Top: 1.5 2nd: 1.5 3rd: 1st oil: 3.0 2nd oil:	Ø: 21.0 Length: 61.5
			Length:	33.3			
			Comp:	33.3			
		Height:	-3.2				
		Reference no.:	Reference no.:	Reference no.:	Reference no.:	O-RING	
			<b>M-S14350</b>	<b>M-E14350</b>	<b>A-R43260</b> <b>G-0830720000</b> <b>K-800021140000</b> <b>M-01163N0</b> <b>T-50010</b>		
NM-Germany Article no. Artikelnummer/ Modelo Número / статья НОМЕР	NM-Germany Article no.	NM-Germany Article no.	NM-Germany Article no.	NM-Germany Article no.	NM-Germany Article no.	NM-Germany Article no.	
			<b>KBSOP40551G</b>	<b>KBOP40551G</b>	<b>KROP40551G</b>		



## DIESEL

ENGINE TYPE Motortyp Type de Moteur Tipo de motor Тип двигателя	LINER KIT Liner Kit Kit de Chemise Camisas de los cilindros лайнер комплект	CYL. LINER Zylinderlaufbuchse Chemise Camisas de los cilindros втулка цилиндра	PISTON + RINGS Kolben + Ringe Piston + Segments Pistón Set Поршень и кольца			PISTON SET Kolben Set Set de Piston Pistón Set поршневой	RINGS SET Kolben Set Segments de Piston Anillos Set кольца	PIN Pin Axe Perno Пин				
<b>M9T</b> <b>670/672/676/678</b> <b>M9T</b> <b>680/686/690/692</b> <b>M9T 694/696/698</b> 4 Cyl 85.0 mm Bore Ø 2,298 cc		Length: Outside Ø: Flange Ø: flange depth	Length: 76.0 Comp: 47.88 Height: -16.2		alfin and with oil gallery fits tapered con. rod	Top: 2.5 half keystone 2nd: 2.0 3rd: 1st oil: 2.0 2nd oil:	Ø: 32.0 Length: 65.0					
								Reference no.:	Reference no.:	Reference no.:	Reference no.:	O-RING
									K-97504600		K-800074810000	
NM-Germany Article no. Artikelnummer/ Modelo Número / статья НОМЕР	NM-Germany Article no.	NM-Germany Article no.	NM-Germany Article no.	NM-Germany Article no.	NM-Germany Article no.	NM-Germany Article no.	NM-Germany Article no.					
			KBSOP40552DB	KBOP40552DB	KROP40552DB							

OPEL



## GASOLINE

ENGINE TYPE Motortyp Type de Moteur Tipo de motor Тип двигателя	LINER KIT Liner Kit Kit de Chemise Camisas de los cilindros лайнер комплект	CYL. LINER Zylinderlaufbuchse Chemise Camisas de los cilindros втулка цилиндра	PISTON + RINGS Kolben + Ringe Piston + Segments Pistón Set Поршень и кольца			PISTON SET Kolben Set Set de Piston Pistón Set поршневой	RINGS SET Kolben Set Segments de Piston Anillos Set кольца	PIN Pin Axe Perno Пин				
<b>20 SE</b> <b>20 SEH</b> <b>20 SER</b> 4 Cyl 86.0 mm Bore Ø 1,998 cc		Length: Outside Ø: Flange Ø: flange depth	Length: 50.4 Comp: 30.4 Height: -5.1			Top: 1.5 2nd: 1.5 3rd: 1st oil: 3.0 2nd oil:	Ø: 21.0 Length: 61.5					
								Reference no.:	Reference no.:	Reference no.:	Reference no.:	O-RING
									H-23394 N-8730680040		903 504 99 903 516 58 904 230 82 A-R43290 G-0830680000 K-800021240000 M-01158N0	
NM-Germany Article no. Artikelnummer/ Modelo Número / статья НОМЕР	NM-Germany Article no.	NM-Germany Article no.	NM-Germany Article no.	NM-Germany Article no.	NM-Germany Article no.	NM-Germany Article no.	NM-Germany Article no.					
			KBSOP40553G	KBOP40553G	KROP40553G							

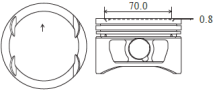

## GASOLINE

ENGINE TYPE Motortyp Type de Moteur Tipo de motor Тип двигателя	LINER KIT Liner Kit Kit de Chemise Camisas de los cilindros лайнер комплект	CYL. LINER Zylinderlaufbuchse Chemise Camisas de los cilindros втулка цилиндра	PISTON + RINGS Kolben + Ringe Piston + Segments Pistón Set Поршень и кольца			PISTON SET Kolben Set Set de Piston Pistón Set поршневой	RINGS SET Kolben Set Segments de Piston Anillos Set кольца	PIN Pin Axe Perno Пин				
<b>C 2.0 NE</b> 4 Cyl 86.0 mm Bore Ø 1,998 cc		Length: Outside Ø: Flange Ø: flange depth	Length: 50.1 Comp: 30.1 Height: -5.0			Top: 1.5 2nd: 1.5 3rd: 1st oil: 3.0 2nd oil:	Ø: 21.0 Length: 61.5					
								Reference no.:	Reference no.:	Reference no.:	Reference no.:	O-RING
											903 504 99 903 516 58 904 230 82 A-R43290 G-0830680000 K-800021240000 M-01158N0	
NM-Germany Article no. Artikelnummer/ Modelo Número / статья НОМЕР	NM-Germany Article no.	NM-Germany Article no.	NM-Germany Article no.	NM-Germany Article no.	NM-Germany Article no.	NM-Germany Article no.	NM-Germany Article no.					
			KBSOP40554G	KBOP40554G	KROP40554G							

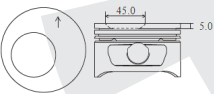

**GASOLINE**

ENGINE TYPE Motortyp Type de Moteur Tipo de motor Тип двигателя	LINER KIT Liner Kit Kit de Chemise Camisas de los cilindros лайнер комплект	CYL. LINER Zylinderlaufbuchse Chemise Camisas de los cilindros втулка цилиндра	PISTON + RINGS Kolben + Ringe Piston + Segments Pistón Set Поршень и кольца		PISTON SET Kolben Set Set de Piston Pistón Set поршневой	RINGS SET Kolben Set Segments de Piston Anillos Set кольца	PIN Pin Axe Perno Пин				
<b>2.0 XEH C 2.0XE</b> 4 Cyl 86.0 mm Bore Ø 1,998 cc 		Length: Outside Ø: Flange Ø: flange depth	Length: 55.4 Comp: 30.4 Height: -0.8			Top: 1.5 2nd: 1.5 3rd: 3.0 1st oil: 3.0 2nd oil:	Ø: 21.0 Length: 61.5				
						Reference no.:		Reference no.:	Reference no.:	Reference no.:	O-RING
								<b>A-24024</b> <b>K-91023700</b> <b>M-0117700</b> <b>N-8730680010</b>	<b>902 994 57</b> <b>904 676 29</b> <b>904 676 37</b> <b>905 096 10</b>	<b>903 504 99</b> <b>903 516 58</b> <b>904 230 82</b> <b>A-R43290</b> <b>G-0830680000</b> <b>K-800021240000</b> <b>M-01158N0</b>	
NM-Germany Article no. Artikelnummer/ Modelo Número / статья НОМЕР	NM-Germany Article no.	NM-Germany Article no.	NM-Germany Article no.	NM-Germany Article no.	NM-Germany Article no.	NM-Germany Article no.	NM-Germany Article no.				
			KBSOP40555G	KBOP40555G	KROP40555G						

**GASOLINE**

ENGINE TYPE Motortyp Type de Moteur Tipo de motor Тип двигателя	LINER KIT Liner Kit Kit de Chemise Camisas de los cilindros лайнер комплект	CYL. LINER Zylinderlaufbuchse Chemise Camisas de los cilindros втулка цилиндра	PISTON + RINGS Kolben + Ringe Piston + Segments Pistón Set Поршень и кольца		PISTON SET Kolben Set Set de Piston Pistón Set поршневой	RINGS SET Kolben Set Segments de Piston Anillos Set кольца	PIN Pin Axe Perno Пин				
<b>X 2.0 SE</b> <b>2.0 SE</b> <b>2.0 SHE/2.0 XE</b> 4 Cyl 86.0 mm Bore Ø 1,998 cc 		Length: Outside Ø: Flange Ø: flange depth	Length: 55.4 Comp: 30.4 Height: -5.0			Top: 1.5 2nd: 1.5 3rd: 3.0 1st oil: 3.0 2nd oil:	Ø: 21.0 Length: 61.5				
						Reference no.:		Reference no.:	Reference no.:	Reference no.:	O-RING
								<b>K-90245600</b> <b>M-0117400</b>	<b>902 653 72</b> <b>903 549 67</b>	<b>903 504 99</b> <b>903 516 58</b> <b>904 230 82</b> <b>A-R43290</b> <b>G-0830680000</b> <b>K-800021240000</b> <b>M-01158N0</b>	
NM-Germany Article no. Artikelnummer/ Modelo Número / статья НОМЕР	NM-Germany Article no.	NM-Germany Article no.	NM-Germany Article no.	NM-Germany Article no.	NM-Germany Article no.	NM-Germany Article no.	NM-Germany Article no.				
			KBSOP40556G	KBOP40556G	KROP40556G						

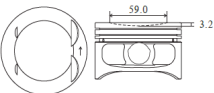
**GASOLINE**

ENGINE TYPE Motortyp Type de Moteur Tipo de motor Тип двигателя	LINER KIT Liner Kit Kit de Chemise Camisas de los cilindros лайнер комплект	CYL. LINER Zylinderlaufbuchse Chemise Camisas de los cilindros втулка цилиндра	PISTON + RINGS Kolben + Ringe Piston + Segments Pistón Set Поршень и кольца		PISTON SET Kolben Set Set de Piston Pistón Set поршневой	RINGS SET Kolben Set Segments de Piston Anillos Set кольца	PIN Pin Axe Perno Пин				
<b>C 2.0 XEV</b> <b>X 2.0 XEV</b> 4 Cyl 86.0 mm Bore Ø 1,998 cc 		Length: Outside Ø: Flange Ø: flange depth	Length: 55.5 55.5 Comp: 30.4 30.1 Height: -3.2 -3.2	STD O/S		Top: 1.5 2nd: 1.5 3rd: 3.0 1st oil: 3.0 2nd oil:	Ø: 21.0 Length: 61.5				
						Reference no.:		Reference no.:	Reference no.:	Reference no.:	O-RING
								<b>K-97332600</b> <b>M-0117300</b>	<b>904 870 97</b>	<b>903 504 99</b> <b>903 516 58</b> <b>904 230 82</b> <b>A-R43290</b> <b>G-0830680000</b> <b>K-800021240000</b> <b>M-01158N0</b>	
NM-Germany Article no. Artikelnummer/ Modelo Número / статья НОМЕР	NM-Germany Article no.	NM-Germany Article no.	NM-Germany Article no.	NM-Germany Article no.	NM-Germany Article no.	NM-Germany Article no.	NM-Germany Article no.				
			KBSOP40557G	KBOP40557G	KROP40557G						

**GASOLINE**

ENGINE TYPE Motortyp Type de Moteur Tipo de motor Тип двигателя	LINER KIT Liner Kit Kit de Chemise Camisas de los cilindros лайнер комплект	CYL. LINER Zylinderlaufbuchse Chemise Camisas de los cilindros втулка цилиндра	PISTON + RINGS Kolben + Ringe Piston + Segments Pistón Set Поршень и кольца		PISTON SET Kolben Set Set de Piston Pistón Set поршневой	RINGS SET Kolben Set Segments de Piston Anillos Set кольца	PIN Pin Axe Perno Пин
<b>C 2.0 SEL</b> <b>X 2.2 SE</b> <b>X 2.2 XE</b>  4 Cyl <b>86.0 mm Bore Ø</b> <b>1,998 cc 2,198 cc</b>		Length: Outside Ø: Flange Ø: flange depth	Length:	STD	O/S	Top: 1.5 2nd: 1.5 3rd: 1.5 1st oil: 3.0 2nd oil:	Ø: 21.0 Length: 61.5
			Length:	55.4	55.4		
			Comp:	30.4	30.1		
			Height:	-6.5	-6.5		
			Reference no.:	Reference no.:	Reference no.:	Reference no.:	O-RING
				<b>K-97363600</b> <b>M-0110300</b>	<b>904 994 20</b> <b>905 010 58</b>	<b>903 504 99</b> <b>903 516 58</b> <b>904 230 82</b> <b>A-R43290</b> <b>G-0830680000</b> <b>K-800021240000</b> <b>M-01158N0</b>	
NM-Germany Article no. Artikelnummer/ Modelo Número / статья НОМЕР	NM-Germany Article no.	NM-Germany Article no.	NM-Germany Article no.	NM-Germany Article no.	NM-Germany Article no.	NM-Germany Article no.	NM-Germany Article no.
			<b>KBSOP40558G</b>	<b>KBOP40558G</b>	<b>KROP40558G</b>		

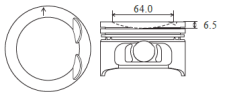

OPEL

**GASOLINE**

ENGINE TYPE Motortyp Type de Moteur Tipo de motor Тип двигателя	LINER KIT Liner Kit Kit de Chemise Camisas de los cilindros лайнер комплект	CYL. LINER Zylinderlaufbuchse Chemise Camisas de los cilindros втулка цилиндра	PISTON + RINGS Kolben + Ringe Piston + Segments Pistón Set Поршень и кольца		PISTON SET Kolben Set Set de Piston Pistón Set поршневой	RINGS SET Kolben Set Segments de Piston Anillos Set кольца	PIN Pin Axe Perno Пин
<b>Z 2.2 SE</b>  4 Cyl <b>86.0 mm Bore Ø</b> <b>2,198 cc</b>		Length: Outside Ø: Flange Ø: flange depth	Length:	48.9		Top: 1.2 2nd: 1.5 3rd: 1.5 1st oil: 2.5 2nd oil:	Ø: 20.0 Length: 62.0
			Comp:	26.75			
			Height:	-0.61			
			Reference no.:	Reference no.:	Reference no.:	Reference no.:	O-RING
				<b>K-94912600</b> <b>M-0121500</b>		<b>K-800049140000</b> <b>M-01220N0</b>	
NM-Germany Article no. Artikelnummer/ Modelo Número / статья НОМЕР	NM-Germany Article no.	NM-Germany Article no.	NM-Germany Article no.	NM-Germany Article no.	NM-Germany Article no.	NM-Germany Article no.	NM-Germany Article no.
			<b>KBSOP40559G</b>	<b>KBOP40559G</b>	<b>KROP40559G</b>		

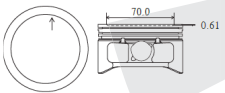



**GASOLINE**

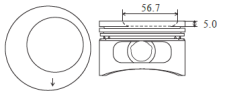

ENGINE TYPE Motortyp Type de Moteur Tipo de motor Тип двигателя	LINER KIT Liner Kit Kit de Chemise Camisas de los cilindros лайнер комплект	CYL. LINER Zylinderlaufbuchse Chemise Camisas de los cilindros втулка цилиндра	PISTON + RINGS Kolben + Ringe Piston + Segments Pistón Set Поршень и кольца		PISTON SET Kolben Set Set de Piston Pistón Set поршневой	RINGS SET Kolben Set Segments de Piston Anillos Set кольца	PIN Pin Axe Perno Пин
<b>C 2.0 NE</b> <b>C 2.0 NZ</b>  4 Cyl <b>86.0 mm Bore Ø</b> <b>1,998 cc</b>		Length: Outside Ø: Flange Ø: flange depth	Length:	STD	O/S	Top: 1.5 2nd: 1.5 3rd: 1.5 1st oil: 3.0 2nd oil:	Ø: 21.0 Length: 61.5
			Length:	55.4	55.1		
			Comp:	30.4	30.1		
			Height:	-5.0	-5.0		
			Reference no.:	Reference no.:	Reference no.:	Reference no.:	O-RING
				<b>K-92123600</b> <b>M-0117500</b>	<b>902 713 51</b> <b>902 713 28</b> <b>902 713 29</b> <b>902 713 30</b> <b>902 713 31</b>	<b>903 504 99</b> <b>903 516 58</b> <b>904 230 82</b> <b>A-R43290</b> <b>G-0830680000</b> <b>K-800021240000</b> <b>M-01158N0</b>	
NM-Germany Article no. Artikelnummer/ Modelo Número / статья НОМЕР	NM-Germany Article no.	NM-Germany Article no.	NM-Germany Article no.	NM-Germany Article no.	NM-Germany Article no.	NM-Germany Article no.	NM-Germany Article no.
			<b>KBSOP40560G</b>	<b>KBOP40560G</b>	<b>KROP40560G</b>		

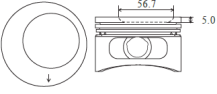

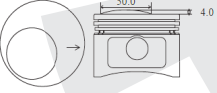

**GASOLINE**

ENGINE TYPE Motortyp Type de Moteur Tipo de motor Тип двигателя	LINER KIT Liner Kit Kit de Chemise Camisas de los cilindros лайнер комплект	CYL. LINER Zylinderlaufbuchse Chemise Camisas de los cilindros втулка цилиндра	PISTON + RINGS Kolben + Ringe Piston + Segments Pistón Set Поршень и кольца			PISTON SET Kolben Set Set de Piston Pistón Set поршневой	RINGS SET Kolben Set Segments de Piston Anillos Set кольца	PIN Pin Axe Perno Пин	
<b>C 2.0 NE</b> <b>C 2.0 NZ</b> 4 Cyl 86.0 mm Bore Ø 1,998 cc 		Length:		Length:	55.4	Top:	1.5	Ø: 21.0 Length: 61.5	
		Outside Ø:		Comp:	30.4	2nd:	1.5		
		Flange Ø:		Height:	-5.0	3rd:			1st oil:
		flange depth				2nd oil:			
		Reference no.:		Reference no.:		Reference no.:		O-RING	
				<b>M-S14290</b>		<b>M-E14290</b>		<b>903 504 99</b> <b>903 516 58</b> <b>904 230 82</b> <b>A-R43290</b> <b>G-0830680000</b> <b>K-800021240000</b> <b>M-01158N0</b>	
NM-Germany Article no. Artikelnummer/ Modelo Número / статья НОМЕР	NM-Germany Article no.	NM-Germany Article no.	NM-Germany Article no.	NM-Germany Article no.	NM-Germany Article no.	NM-Germany Article no.	NM-Germany Article no.	NM-Germany Article no.	
			<b>KBSOP40561G</b>	<b>KBOP40561G</b>	<b>KROP40561G</b>				

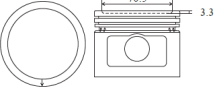

**GASOLINE**

ENGINE TYPE Motortyp Type de Moteur Tipo de motor Тип двигателя	LINER KIT Liner Kit Kit de Chemise Camisas de los cilindros лайнер комплект	CYL. LINER Zylinderlaufbuchse Chemise Camisas de los cilindros втулка цилиндра	PISTON + RINGS Kolben + Ringe Piston + Segments Pistón Set Поршень и кольца			PISTON SET Kolben Set Set de Piston Pistón Set поршневой	RINGS SET Kolben Set Segments de Piston Anillos Set кольца	PIN Pin Axe Perno Пин	
<b>GM 2.0 YVH</b> 4 Cyl 86.0 mm Bore Ø 1,998 cc 		Length:		Length:	61.4	Top:	1.5	Ø: 21.0 Length: 61.5	
		Outside Ø:		Comp:	30.4	2nd:	1.5		
		Flange Ø:		Height:	4.0	3rd:			1st oil:
		flange depth				2nd oil:			
		Reference no.:		Reference no.:		Reference no.:		O-RING	
				<b>M-S14250</b>		<b>M-E14250</b>		<b>903 504 99</b> <b>903 516 58</b> <b>904 230 82</b> <b>A-R43290</b> <b>G-0830680000</b> <b>K-800021240000</b> <b>M-01158N0</b>	
NM-Germany Article no. Artikelnummer/ Modelo Número / статья НОМЕР	NM-Germany Article no.	NM-Germany Article no.	NM-Germany Article no.	NM-Germany Article no.	NM-Germany Article no.	NM-Germany Article no.	NM-Germany Article no.	NM-Germany Article no.	
			<b>KBSOP40562G</b>	<b>KBOP40562G</b>	<b>KROP40562G</b>				

**GASOLINE**

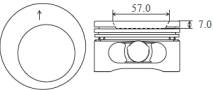

ENGINE TYPE Motortyp Type de Moteur Tipo de motor Тип двигателя	LINER KIT Liner Kit Kit de Chemise Camisas de los cilindros лайнер комплект	CYL. LINER Zylinderlaufbuchse Chemise Camisas de los cilindros втулка цилиндра	PISTON + RINGS Kolben + Ringe Piston + Segments Pistón Set Поршень и кольца			PISTON SET Kolben Set Set de Piston Pistón Set поршневой	RINGS SET Kolben Set Segments de Piston Anillos Set кольца	PIN Pin Axe Perno Пин	
<b>GM 2.0L GAS</b> 4 Cyl 86.0 mm Bore Ø 1,998 cc 		Length:		Length:	50.0	Top:	1.5	Ø: 21.0 Length: 61.5	
		Outside Ø:		Comp:	30.0	2nd:	1.5		
		Flange Ø:		Height:	-3.3	3rd:			1st oil:
		flange depth				2nd oil:			
		Reference no.:		Reference no.:		Reference no.:		O-RING	
				<b>M-S14270</b>		<b>M-E14270</b>		<b>903 504 99</b> <b>903 516 58</b> <b>904 230 82</b> <b>A-R43290</b> <b>G-0830680000</b> <b>K-800021240000</b> <b>M-01158N0</b>	
NM-Germany Article no. Artikelnummer/ Modelo Número / статья НОМЕР	NM-Germany Article no.	NM-Germany Article no.	NM-Germany Article no.	NM-Germany Article no.	NM-Germany Article no.	NM-Germany Article no.	NM-Germany Article no.	NM-Germany Article no.	
			<b>KBSOP40563G</b>	<b>KBOP40563G</b>	<b>KROP40563G</b>				

**GASOLINE**

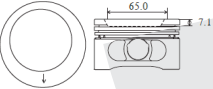

ENGINE TYPE Motortyp Type de Moteur Tipo de motor Тип двигателя	LINER KIT Liner Kit Kit de Chemise Camisas de los cilindros лайнер комплект	CYL. LINER Zylinderlaufbuchse Chemise Camisas de los cilindros втулка цилиндра	PISTON + RINGS Kolben + Ringe Piston + Segments Pistón Set Поршень и кольца			PISTON SET Kolben Set Set de Piston Pistón Set поршневой	RINGS SET Kolben Set Segments de Piston Anillos Set кольца	PIN Pin Axe Perno Пин			
<b>GM 2.2L EFI GM 2.2L MPFI</b> 4 Cyl 86.0 mm Bore Ø 2,198 cc 		Length: Outside Ø: Flange Ø: flange depth	Length: 50.0 Comp: 30.0 Height: -7.0			Top: 1.5 2nd: 1.5 3rd: 1st oil: 3.0 2nd oil: Length: 62.0	Ø: 21.0 Length: 62.0				
						Reference no.:		Reference no.:	Reference no.:	Reference no.:	O-RING
											903 504 99 903 516 58 904 230 82 A-R43290 G-0830680000 K-800021240000 M-01158N0
NM-Germany Article no. Artikelnummer/ Modelo Número / статья НОМЕР	NM-Germany Article no.	NM-Germany Article no.	NM-Germany Article no.	NM-Germany Article no.	NM-Germany Article no.	NM-Germany Article no.	NM-Germany Article no.				
			KBSOP40564G	KBOP40564G	KROP40564G						

OPEL

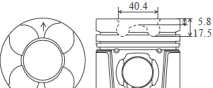

**GASOLINE**

ENGINE TYPE Motortyp Type de Moteur Tipo de motor Тип двигателя	LINER KIT Liner Kit Kit de Chemise Camisas de los cilindros лайнер комплект	CYL. LINER Zylinderlaufbuchse Chemise Camisas de los cilindros втулка цилиндра	PISTON + RINGS Kolben + Ringe Piston + Segments Pistón Set Поршень и кольца			PISTON SET Kolben Set Set de Piston Pistón Set поршневой	RINGS SET Kolben Set Segments de Piston Anillos Set кольца	PIN Pin Axe Perno Пин			
<b>C 22 NE</b> 4 Cyl 86.0 mm Bore Ø 2,189 cc 		Length: Outside Ø: Flange Ø: flange depth	Length: 50.0 Comp: 30.0 Height: -7.1			Top: 1.5 2nd: 1.5 3rd: 1st oil: 3.0 2nd oil: Length: 61.5	Ø: 21.0 Length: 61.5				
						Reference no.:		Reference no.:	Reference no.:	Reference no.:	O-RING
								K-97333605			903 504 99 903 516 58 904 230 82 A-R43290 G-0830680000 K-800021240000 M-01158N0
NM-Germany Article no. Artikelnummer/ Modelo Número / статья НОМЕР	NM-Germany Article no.	NM-Germany Article no.	NM-Germany Article no.	NM-Germany Article no.	NM-Germany Article no.	NM-Germany Article no.	NM-Germany Article no.				
			KBSOP40565G	KBOP40565G	KROP40565G						

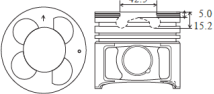

**DIESEL**

ENGINE TYPE Motortyp Type de Moteur Tipo de motor Тип двигателя	LINER KIT Liner Kit Kit de Chemise Camisas de los cilindros лайнер комплект	CYL. LINER Zylinderlaufbuchse Chemise Camisas de los cilindros втулка цилиндра	PISTON + RINGS Kolben + Ringe Piston + Segments Pistón Set Поршень и кольца			PISTON SET Kolben Set Set de Piston Pistón Set поршневой	RINGS SET Kolben Set Segments de Piston Anillos Set кольца	PIN Pin Axe Perno Пин			
<b>G9T 720 G9T 722 G9T 750</b> 4 Cyl 87.0 mm Bore Ø 2,188 cc 		Length: 162.0 Outside Ø: 91.05 Flange Ø: 92.5 flange depth 4.0	Length: 84.2 Comp: 54.53 Height: -5.8 -17.5		alfin skirt MOS2 treated fits tapered con. rod	Top: 3.0 half keystone 2nd: 1.75 3rd: 1st oil: 2.5 2nd oil: Length: 65.0	Ø: 31.0 Length: 65.0				
						Reference no.:		Reference no.:	Reference no.:	Reference no.:	O-RING
								K-99469600 N-8712740000			A-R66780 G-0812740000 K-800051040000 M-02207N0
NM-Germany Article no. Artikelnummer/ Modelo Número / статья НОМЕР	NM-Germany Article no.	NM-Germany Article no.	NM-Germany Article no.	NM-Germany Article no.	NM-Germany Article no.	NM-Germany Article no.	NM-Germany Article no.				
	LBSOP40566DSA	LBOP40566DSA	KBSOP40566DA	KBOP40566DA	KROP40566DA						



**DIESEL**

ENGINE TYPE Motortyp Type de Moteur Tipo de motor Тип двигателя	LINER KIT Liner Kit Kit de Chemise Camisas de los cilindros лайнер комплект	CYL. LINER Zylinderlaufbuchse Chemise Camisas de los cilindros втулка цилиндра	PISTON + RINGS Kolben + Ringe Piston + Segments Pistón Set Поршень и кольца			PISTON SET Kolben Set Set de Piston Pistón Set поршень	RINGS SET Kolben Set Segments de Piston Anillos Set кольца	PIN Pin Axe Perno Пин			
<b>Y 30 DT</b> 6 Cyl 87.5 mm Bore Ø 2,958 cc 		Length: Outside Ø: Flange Ø: flange depth	Length: 72.4 Comp: 44.1 Height: -5.0 -15.2		alfin and with oil gallery skirt MOS2 treated	Top: 2.5 2nd: 1.5 3rd: 1st oil: 3.0 2nd oil:	Ø: 28.5 Length: 70.0				
						Reference no.:		Reference no.:	Reference no.:	Reference no.:	O-RING
								<b>97731064</b> <b>97731065</b> <b>97731066</b>		<b>97257335</b>	
NM-Germany Article no. Artikelnummer/ Modelo Número / статья НОМЕР	NM-Germany Article no.	NM-Germany Article no.	NM-Germany Article no.	NM-Germany Article no.	NM-Germany Article no.	NM-Germany Article no.	NM-Germany Article no.				
			<b>KBSOP60567DB</b>	(for cyl RH)		<b>KBOP60567DB</b>					

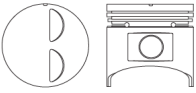

**DIESEL**

ENGINE TYPE Motortyp Type de Moteur Tipo de motor Тип двигателя	LINER KIT Liner Kit Kit de Chemise Camisas de los cilindros лайнер комплект	CYL. LINER Zylinderlaufbuchse Chemise Camisas de los cilindros втулка цилиндра	PISTON + RINGS Kolben + Ringe Piston + Segments Pistón Set Поршень и кольца			PISTON SET Kolben Set Set de Piston Pistón Set поршень	RINGS SET Kolben Set Segments de Piston Anillos Set кольца	PIN Pin Axe Perno Пин			
<b>Y 30 DT</b> 6 Cyl 87.5 mm Bore Ø 2,958 cc 		Length: Outside Ø: Flange Ø: flange depth	Length: 72.4 Comp: 44.1 Height: -5.0 -15.2		alfin and with oil gallery skirt MOS2 treated	Top: 2.5 2nd: 1.5 3rd: 1st oil: 3.0 2nd oil:	Ø: 28.5 Length: 70.0				
						Reference no.:		Reference no.:	Reference no.:	Reference no.:	O-RING
								<b>97731067</b> <b>97731068</b> <b>97731069</b>		<b>97257335</b>	
NM-Germany Article no. Artikelnummer/ Modelo Número / статья НОМЕР	NM-Germany Article no.	NM-Germany Article no.	NM-Germany Article no.	NM-Germany Article no.	NM-Germany Article no.	NM-Germany Article no.	NM-Germany Article no.				
			<b>KBSOP60568DB</b>	(for cyl LH)		<b>KBOP60568DB</b>					

**GASOLINE**

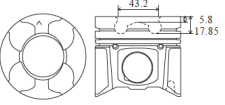

ENGINE TYPE Motortyp Type de Moteur Tipo de motor Тип двигателя	LINER KIT Liner Kit Kit de Chemise Camisas de los cilindros лайнер комплект	CYL. LINER Zylinderlaufbuchse Chemise Camisas de los cilindros втулка цилиндра	PISTON + RINGS Kolben + Ringe Piston + Segments Pistón Set Поршень и кольца			PISTON SET Kolben Set Set de Piston Pistón Set поршень	RINGS SET Kolben Set Segments de Piston Anillos Set кольца	PIN Pin Axe Perno Пин			
<b>1.7 L</b> <b>1.7 S</b> 4 Cyl 88.0 mm Bore Ø 1,698 cc 		Length: Outside Ø: Flange Ø: flange depth	Length: 87.0 Comp: 45.0 Height: 0			Top: 2.0 2nd: 2.0 3rd: 1st oil: 5.0 2nd oil:	Ø: 23.0 Length: 76.0				
						Reference no.:		Reference no.:	Reference no.:	Reference no.:	O-RING
NM-Germany Article no. Artikelnummer/ Modelo Número / статья НОМЕР	NM-Germany Article no.	NM-Germany Article no.	NM-Germany Article no.	NM-Germany Article no.	NM-Germany Article no.	NM-Germany Article no.	NM-Germany Article no.				
			<b>KBSOP40569G</b>	<b>KBOP40569G</b>		<b>KROP40569G</b>					

**DIESEL**

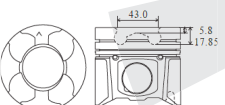

ENGINE TYPE	LINER KIT	CYL. LINER	PISTON + RINGS			PISTON SET	RINGS SET	PIN
Motor typ Type de Moteur Tipo de motor Тип двигателя	Liner Kit Kit de Chemise Camisas de los cilindros лайнер комплект	Zylinderlaufbuchse Chemise Camisas de los cilindros втулка цилиндра	Kolben + Ringe Piston + Segments Pistón Set Поршень и кольца			Kolben Set Set de Piston Pistón Set поршневой	Kolben Set Segments de Piston Anillos Set кольца	Pin Axe Perno Пин
<b>G9U 720/724</b> <b>G9U 730/750/754</b> 4 Cyl 89.0 mm Bore Ø 2,463 cc		Length: 167.0 Outside Ø: 92.5 Flange Ø: 94.0 flange depth 4.0	Length: 83.09 Comp: 53.03 Height: -5.8 -17.85			alfin skirt MOS2 treated fits tapered con. rod	Top: 3.0 half keystone 2nd: 1.75 3rd: 1st oil: 2.5 2nd oil:	Ø: 31.0 Length: 65.0
								
NM-Germany Article no. Artikelnummer/ Modelo Número / статья НОМЕР	NM-Germany Article no.	NM-Germany Article no.	NM-Germany Article no.	NM-Germany Article no.	NM-Germany Article no.	NM-Germany Article no.	NM-Germany Article no.	NM-Germany Article no.
	LBSOP40570DSA	LBOP40570DSA	KBSOP40570DA	KBOP40570DA	KROP40570DA			

OPEL

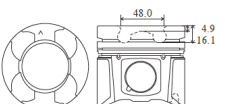

**DIESEL**

ENGINE TYPE	LINER KIT	CYL. LINER	PISTON + RINGS			PISTON SET	RINGS SET	PIN
Motor typ Type de Moteur Tipo de motor Тип двигателя	Liner Kit Kit de Chemise Camisas de los cilindros лайнер комплект	Zylinderlaufbuchse Chemise Camisas de los cilindros втулка цилиндра	Kolben + Ringe Piston + Segments Pistón Set Поршень и кольца			Kolben Set Set de Piston Pistón Set поршневой	Kolben Set Segments de Piston Anillos Set кольца	Pin Axe Perno Пин
<b>G9U 720/724</b> <b>G9U 730/750/754</b> 4 Cyl 89.0 mm Bore Ø 2,463 cc		Length: 167.0 Outside Ø: 92.5 Flange Ø: 94.0 flange depth 4.0	Length: 83.09 Comp: 53.03 Height: -5.8 -17.85			alfin skirt MOS2 treated fits tapered con. rod	Top: 2.5 2nd: 1.75 3rd: 1st oil: 2.5 2nd oil:	Ø: 31.0 Length: 65.0
								
NM-Germany Article no. Artikelnummer/ Modelo Número / статья НОМЕР	NM-Germany Article no.	NM-Germany Article no.	NM-Germany Article no.	NM-Germany Article no.	NM-Germany Article no.	NM-Germany Article no.	NM-Germany Article no.	NM-Germany Article no.
	LBSOP40571DSA	LBOP40571DSA	KBSOP40571DA	KBOP40571DA	KROP40571DA			

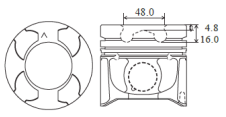

**DIESEL**

ENGINE TYPE	LINER KIT	CYL. LINER	PISTON + RINGS			PISTON SET	RINGS SET	PIN
Motor typ Type de Moteur Tipo de motor Тип двигателя	Liner Kit Kit de Chemise Camisas de los cilindros лайнер комплект	Zylinderlaufbuchse Chemise Camisas de los cilindros втулка цилиндра	Kolben + Ringe Piston + Segments Pistón Set Поршень и кольца			Kolben Set Set de Piston Pistón Set поршневой	Kolben Set Segments de Piston Anillos Set кольца	Pin Axe Perno Пин
<b>G9U 650</b> 4 Cyl 89.0 mm Bore Ø 2,463 cc		Length: 167.0 Outside Ø: 92.5 Flange Ø: 94.0 flange depth 4.0	Length: 83.09 Comp: 53.03 Height: -4.9 -16.1			alfin skirt MOS2 treated fits tapered con. rod	Top: 3.0 half keystone 2nd: 1.75 3rd: 1st oil: 2.5 2nd oil:	Ø: 31.0 Length: 65.0
								
NM-Germany Article no. Artikelnummer/ Modelo Número / статья НОМЕР	NM-Germany Article no.	NM-Germany Article no.	NM-Germany Article no.	NM-Germany Article no.	NM-Germany Article no.	NM-Germany Article no.	NM-Germany Article no.	NM-Germany Article no.
	LBSOP40572DSA	LBOP40572DSA	KBSOP40572DA	KBOP40572DA	KROP40572DA			

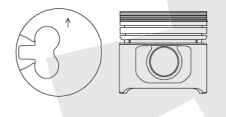

**DIESEL**

ENGINE TYPE Motortyp Type de Moteur Tipo de motor Тип двигателя	LINER KIT Liner Kit Kit de Chemise Camisas de los cilindros лайнер комплект	CYL. LINER Zylinderlaufbuchse Chemise Camisas de los cilindros втулка цилиндра	PISTON + RINGS Kolben + Ringe Piston + Segments Pistón Set Поршень и кольца	PISTON SET Kolben Set Set de Piston Pistón Set поршень	RINGS SET Kolben Set Segments de Piston Anillos Set кольца	PIN Pin Axe Perno Пин	
<b>G9U 630</b> 4 Cyl 89.0 mm Bore Ø 2,463 cc 		Length: 167.0 Outside Ø: 92.5 Flange Ø: 94.0 flange depth 4.0	Length: 83.1 Comp: 53.1 Height: -4.8 -16.0	alfin and with oil gallery skirt MOS2 treated fits tapered con. rod	Top: 3.0 half keystone 2nd: 1.75 3rd: 1st oil: 2.5 2nd oil:	Ø: 31.0 Length: 68.0	
		Reference no.:	Reference no.:		Reference no.:	Reference no.:	O-RING
			<b>K-40272600</b>			<b>A-R66720 G-0813750000 K-800053240000 K-800059040000 M-02213N0</b>	
NM-Germany Article no. Artikelnummer/ Modelo Número / статья HOMEP	NM-Germany Article no.	NM-Germany Article no.	NM-Germany Article no.	NM-Germany Article no.	NM-Germany Article no.	NM-Germany Article no.	
	<b>LBSOP40573DSB</b>	<b>LBOP40573DSB</b>	<b>KBSOP40573DB</b>	<b>KBOP40573DB</b>	<b>KROP40573DB</b>		

**DIESEL**

ENGINE TYPE Motortyp Type de Moteur Tipo de motor Тип двигателя	LINER KIT Liner Kit Kit de Chemise Camisas de los cilindros лайнер комплект	CYL. LINER Zylinderlaufbuchse Chemise Camisas de los cilindros втулка цилиндра	PISTON + RINGS Kolben + Ringe Piston + Segments Pistón Set Поршень и кольца	PISTON SET Kolben Set Set de Piston Pistón Set поршень	RINGS SET Kolben Set Segments de Piston Anillos Set кольца	PIN Pin Axe Perno Пин	
<b>23 D</b> <b>23 YD</b> 4 Cyl 92.0 mm Bore Ø 2,260 cc 	<b>K-93956960</b> <b>M-0118890</b>	Length: 172.0 Outside Ø: 95.0 Flange Ø: 97.0 flange depth 4.55	Length: 86.65 Comp: 53.65 Height: -1.8	alfin head anodized	Top: 2.0 2nd: 2.0 3rd: 1st oil: 4.0 2nd oil:	Ø: 30.0 Length: 74.0	
		Reference no.:	Reference no.:		Reference no.:	Reference no.:	O-RING
		<b>901 080 89</b> <b>901 691 25</b> <b>K-89048190</b> <b>M-011WV03</b>	<b>K-93956600</b> <b>M-0118800</b>		<b>900 067 08</b> <b>900 067 10</b> <b>900 165 23</b> <b>900 165 24</b> <b>900 165 25</b> <b>900 165 26</b> <b>900 165 27</b> <b>900 165 28</b> <b>900 165 29</b> <b>902.987.13</b>	<b>G-0830540010</b> <b>K-800021540000</b> <b>M-01188N0</b>	
NM-Germany Article no. Artikelnummer/ Modelo Número / статья HOMEP	NM-Germany Article no.	NM-Germany Article no.	NM-Germany Article no.	NM-Germany Article no.	NM-Germany Article no.	NM-Germany Article no.	
	<b>LBSOP40574DSA</b>	<b>LBOP40574DSA</b>	<b>KBSOP40574DA</b>	<b>KBOP40574DA</b>	<b>KROP40574DA</b>		

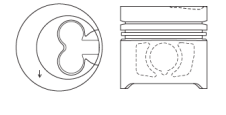
**DIESEL**

ENGINE TYPE Motortyp Type de Moteur Tipo de motor Тип двигателя	LINER KIT Liner Kit Kit de Chemise Camisas de los cilindros лайнер комплект	CYL. LINER Zylinderlaufbuchse Chemise Camisas de los cilindros втулка цилиндра	PISTON + RINGS Kolben + Ringe Piston + Segments Pistón Set Поршень и кольца	PISTON SET Kolben Set Set de Piston Pistón Set поршень	RINGS SET Kolben Set Segments de Piston Anillos Set кольца	PIN Pin Axe Perno Пин	
<b>23 DTR TURBO</b> <b>23 TD TURBO</b> <b>23 YDT TURBO</b> 4 Cyl 92.0 mm Bore Ø 2,260 cc 	<b>K-91022960</b> <b>M-0118890</b>	Length: 172.0 Outside Ø: 95.0 Flange Ø: 97.0 flange depth 4.55	Length: 86.65 Comp: 53.65 Height: -1.3 -3.5	alfin and with oil gallery head anodized skirt MOS2 treated	Top: 2.5 double key-stone 2nd: 2.0 3rd: 1st oil: 4.0 2nd oil:	Ø: 30.0 Length: 78.0	
		Reference no.:	Reference no.:		Reference no.:	Reference no.:	O-RING
		<b>901 080 89</b> <b>901 691 25</b> <b>K-89048190</b> <b>M-011WV03</b>	<b>K-91022600</b> <b>M-0118500</b>		<b>903 523 10</b>	<b>G-0830660000</b> <b>K-800021640000</b> <b>M-01185N0</b>	
NM-Germany Article no. Artikelnummer/ Modelo Número / статья HOMEP	NM-Germany Article no.	NM-Germany Article no.	NM-Germany Article no.	NM-Germany Article no.	NM-Germany Article no.	NM-Germany Article no.	
	<b>LBSOP40575DSB</b>	<b>LBOP40575DSB</b>	<b>KBSOP40575DB</b>	<b>KBOP40575DB</b>	<b>KROP40575DB</b>		



**DIESEL**

ENGINE TYPE Motortyp Type de Moteur Tipo de motor Тип двигателя	LINER KIT Liner Kit Kit de Chemise Camisas de los cilindros лайнер комплект	CYL. LINER Zylinderlaufbuchse Chemise Camisas de los cilindros втулка цилиндра	PISTON + RINGS Kolben + Ringe Piston + Segments Pistón Set Поршень и кольца		PISTON SET Kolben Set Set de Piston Pistón Set поршневой	RINGS SET Kolben Set Segments de Piston Anillos Set кольца	PIN Pin Axe Perno Пин
<b>VM TURBO</b> 4 Cyl 92.0 mm Bore Ø 2,499 cc	<b>A-ASA2460</b> <b>K-92286961</b> <b>K-92286971</b> <b>M-4891390</b> <b>N-8911010000</b>	Length: 168.0 Outside Ø: 103.0 Flange Ø: 110.0 flange depth 8.9 +1.2	Length: 86.1 Comp: 51.1 Height: -2.3 -3.9		alfin head and top ring land anodized	Top: 2.5 double key- stone 2nd: 2.0 3rd: 2.0 1st oil: 4.0 2nd oil:	Ø: 30.0 Length: 75.5
			<b>A-SJ351453</b> <b>G-1467642000</b> <b>K-89500110</b> <b>M-489WN01</b>	<b>K-92286600</b> <b>K-92286700</b> <b>M-4891300</b>		<b>A-R47730</b> <b>G-0811010000</b> <b>K-800000110000</b> <b>M-48912N0</b>	<b>OROP40576DA</b>
NM-Germany Article no. Artikelnummer/ Modelo Número / статья НОМЕР	NM-Germany Article no.	NM-Germany Article no.	NM-Germany Article no.	NM-Germany Article no.	NM-Germany Article no.	NM-Germany Article no.	NM-Germany Article no.
	<b>LBSOP40576DFA</b>	<b>LBOP40576DFA</b>	<b>KBSOP40576DA</b>	<b>KBOP40576DA</b>	<b>KROP40576DA</b>		

OPEL

**DIESEL**

ENGINE TYPE Motortyp Type de Moteur Tipo de motor Тип двигателя	LINER KIT Liner Kit Kit de Chemise Camisas de los cilindros лайнер комплект	CYL. LINER Zylinderlaufbuchse Chemise Camisas de los cilindros втулка цилиндра	PISTON + RINGS Kolben + Ringe Piston + Segments Pistón Set Поршень и кольца		PISTON SET Kolben Set Set de Piston Pistón Set поршневой	RINGS SET Kolben Set Segments de Piston Anillos Set кольца	PIN Pin Axe Perno Пин
<b>4JA1</b> 4 Cyl 93.0 mm Bore Ø 2,499 cc		(A) (B) Length: 156.0 156.3 Outside Ø: 95.0 98.0 Flange Ø: 101.0 102.0 flange depth 0.9 4.0	Length: 87.9 Comp: 47.9 Height: -8.7 -14.5		alfin	Top: 2.0 2nd: 2.0 3rd: 2.0 1st oil: 4.0 2nd oil:	Ø: 31.0 Length: 76.0
			<b>8-94110-144-0</b> <b>8-94462-130-0</b>  (A) chromed (B) cast iron	<b>A-A350762</b> <b>K-99340600</b> <b>N-8724800000</b>		<b>A-R43680</b> <b>G-082480010</b> <b>K-800036840000</b>	
NM-Germany Article no. Artikelnummer/ Modelo Número / статья НОМЕР	NM-Germany Article no.	NM-Germany Article no.	NM-Germany Article no.	NM-Germany Article no.	NM-Germany Article no.	NM-Germany Article no.	NM-Germany Article no.
	<b>LBSOP40577DCA</b> <b>LBSOP40577DSA</b>	<b>LBOP40577DCA (A)</b> <b>LBOP40577DSA (B)</b>	<b>KBSOP40577DA</b>	<b>KBOP40577DA</b>	<b>KROP40577DA</b>		

**DIESEL**

ENGINE TYPE Motortyp Type de Moteur Tipo de motor Тип двигателя	LINER KIT Liner Kit Kit de Chemise Camisas de los cilindros лайнер комплект	CYL. LINER Zylinderlaufbuchse Chemise Camisas de los cilindros втулка цилиндра	PISTON + RINGS Kolben + Ringe Piston + Segments Pistón Set Поршень и кольца		PISTON SET Kolben Set Set de Piston Pistón Set поршневой	RINGS SET Kolben Set Segments de Piston Anillos Set кольца	PIN Pin Axe Perno Пин
<b>S9W 700 TURBO</b> <b>S9W 702 TURBO</b> 4 Cyl 94.4 mm Bore Ø 2,798 cc	<b>K-94701960</b> <b>M-0098990</b>	Length: 167.0 Outside Ø: 97.5 Flange Ø: 100.9 flange depth 5.0	Length: 87.6 Comp: 58.8 Height: -15.1 -19.45		alfin and with oil gallery skirt MOS2 treated fits tapered con. rod	Top: 2.5 double key- stone 2nd: 2.0 3rd: 2.0 1st oil: 2.5 2nd oil:	Ø: 32.0 Length: 72.0
			<b>G-1402839000</b> <b>K-89502190</b> <b>M-007WV56</b>	<b>A-A350582</b> <b>K-94701600</b> <b>M-0098900</b>		<b>A-R60070</b> <b>G-0812220000</b> <b>K-800038241000</b> <b>M-00990N0</b>	
NM-Germany Article no. Artikelnummer/ Modelo Número / статья НОМЕР	NM-Germany Article no.	NM-Germany Article no.	NM-Germany Article no.	NM-Germany Article no.	NM-Germany Article no.	NM-Germany Article no.	NM-Germany Article no.
	<b>LBSOP40578DSB</b>	<b>LBOP40578DSB</b>	<b>KBSOP40578DB</b>	<b>KBOP40578DB</b>	<b>KROP40578DB</b>		

**GASOLINE**

ENGINE TYPE Motortyp Type de Moteur Tipo de motor Тип двигателя	LINER KIT Liner Kit Kit de Chemise Camisas de los cilindros лайнер комплект	CYL. LINER Zylinderlaufbuchse Chemise Camisas de los cilindros втулка цилиндра	PISTON + RINGS Kolben + Ringe Piston + Segments Pistón Set Поршень и кольца			PISTON SET Kolben Set Set de Piston Pistón Set поршень	RINGS SET Kolben Set Segments de Piston Anillos Set кольца	PIN Pin Axe Perno Пин
<b>2.0 E/2.0 S</b> <b>3.0 E/3.0 H</b> 4/6 Cyl 95.0 mm Bore Ø 1,979 cc 2,969 cc		Length: Outside Ø: Flange Ø: flange depth	STD	0.50	1.00	Top: 2.0 2nd: 2.0 3rd: 1st oil: 4.0 2nd oil:	Ø: 23.0  Length: 76.0	
			Length: 87.0	86.7				
			Comp: 45.0	44.7				
Reference no.:			Reference no.:		Reference no.:	Reference no.:	O-RING	
			<b>H-20478</b> <b>K-93221600</b> <b>M-0119000</b>		<b>900 912 78</b> <b>900 961 20</b>	<b>A-R41350V1</b> <b>G-0830500000</b> <b>K-800021720000</b> <b>M-01144N0</b>		
NM-Germany Article no. Artikelnummer/ Modelo Número / статья НОМЕР	NM-Germany Article no.	NM-Germany Article no.	NM-Germany Article no.	NM-Germany Article no.	NM-Germany Article no.	NM-Germany Article no.	NM-Germany Article no.	
			<b>KBSOP460579G</b>	<b>KBOP460579G</b>	<b>KROP460579G</b>			



**GASOLINE**

ENGINE TYPE Motortyp Type de Moteur Tipo de motor Тип двигателя	LINER KIT Liner Kit Kit de Chemise Camisas de los cilindros лайнер комплект	CYL. LINER Zylinderlaufbuchse Chemise Camisas de los cilindros втулка цилиндра	PISTON + RINGS Kolben + Ringe Piston + Segments Pistón Set Поршень и кольца			PISTON SET Kolben Set Set de Piston Pistón Set поршень	RINGS SET Kolben Set Segments de Piston Anillos Set кольца	PIN Pin Axe Perno Пин
<b>C 24 NE</b> 4 Cyl 95.0 mm Bore Ø 2,410 cc		Length: Outside Ø: Flange Ø: flange depth	Length: 61.0			Top: 1.5 2nd: 1.5 3rd: 1st oil: 3.0 2nd oil:	Ø: 22.0  Length: 65.0	
			Comp: 31.5					
			Height: -2.25					
Reference no.:			Reference no.:		Reference no.:	Reference no.:	O-RING	
			<b>H-24089</b> <b>K-91937600</b> <b>M-0119500</b>		<b>903 237 19</b>	<b>A-R49610</b> <b>G-0830730000</b> <b>M-01195N0</b>		
NM-Germany Article no. Artikelnummer/ Modelo Número / статья НОМЕР	NM-Germany Article no.	NM-Germany Article no.	NM-Germany Article no.	NM-Germany Article no.	NM-Germany Article no.	NM-Germany Article no.	NM-Germany Article no.	
			<b>KBSOP40580G</b>	<b>KBOP40580G</b>	<b>KROP40580G</b>			

**DIESEL**

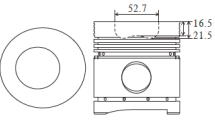

ENGINE TYPE Motortyp Type de Moteur Tipo de motor Тип двигателя	LINER KIT Liner Kit Kit de Chemise Camisas de los cilindros лайнер комплект	CYL. LINER Zylinderlaufbuchse Chemise Camisas de los cilindros втулка цилиндра	PISTON + RINGS Kolben + Ringe Piston + Segments Pistón Set Поршень и кольца			PISTON SET Kolben Set Set de Piston Pistón Set поршень	RINGS SET Kolben Set Segments de Piston Anillos Set кольца	PIN Pin Axe Perno Пин
<b>4JX1T</b> 4 Cyl 95.4 mm Bore Ø 2,999 cc		(A) (B) Length: 177.0 180.0 Outside Ø: 99.4 99.4 Flange Ø: 103.4 flange depth 4.0	Length: 101.7			alfin and with oil gallery head anodized skirt MOS2 treated fits tapered con. rod	Top: 2.5 double keystone 2nd: 2.0 3rd: 1st oil: 4.0 2nd oil:	Ø: 31.0  Length: 75.9
			Comp: 50.0					
			Height: -9.6					
Reference no.:			Reference no.:		Reference no.:	Reference no.:	O-RING	
			<b>K-40056600</b>					
NM-Germany Article no. Artikelnummer/ Modelo Número / статья НОМЕР	NM-Germany Article no.	NM-Germany Article no.	NM-Germany Article no.	NM-Germany Article no.	NM-Germany Article no.	NM-Germany Article no.	NM-Germany Article no.	
	<b>LBSOP0481DPB</b> <b>LBSOP0481DSB</b>	<b>LBOP0481DSB (A)</b> <b>LBOP0481DSB (B)</b>	<b>KBSOP0481DB</b>	<b>KBOP0481DB</b>	<b>KROP0481DB</b>			

DIESEL

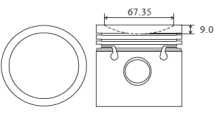

ENGINE TYPE Motortyp Type de Moteur Tipo de motor Тип двигателя	LINER KIT Liner Kit Kit de Chemise Camisas de los cilindros лайнер комплект	CYL. LINER Zylinderlaufbuchse Chemise Camisas de los cilindros втулка цилиндра	PISTON + RINGS Kolben + Ringe Piston + Segments Pistón Set Поршень и кольца			PISTON SET Kolben Set Set de Piston Pistón Set поршневой	RINGS SET Kolben Set Segments de Piston Anillos Set кольца	PIN Pin Axe Perno Пин
<b>J 330</b>	<b>K-93918971</b> <b>M-0691880</b>	Length: 216.3	Length: 118.2			Top: 2.385	Ø: 34.92 Length: 87.9	
		Outside Ø: 107.95	Comp: 71.5			2nd: 2.39		
		Flange Ø: 111.13	Height: -16.5			3rd: 2.39		
<b>Cyl</b> 103.18 mm Bore Ø 5,407 cc		flange depth 4.76	-21.5			1st oil: 4.747		
						2nd oil: 4.747		
		<b>Reference no.:</b>	<b>Reference no.:</b>	<b>Reference no.:</b>	<b>Reference no.:</b>	<b>O-RING</b>		
		<b>7191818</b> <b>A-SU497301</b> <b>K-88041190</b> <b>M-069VV03</b> <b>G-1402114000</b>	<b>A-350083V1</b> <b>K-93918700</b> <b>M-0691810</b> <b>N-8712630010</b>			<b>2716607</b> <b>A-R40150</b> <b>K-800001510000</b> <b>G-0812630010</b>		
								
NM-Germany Article no. Artikelnummer/ Modelo Número / статья НОМЕР	NM-Germany Article no.	NM-Germany Article no.	NM-Germany Article no.	NM-Germany Article no.	NM-Germany Article no.	NM-Germany Article no.	NM-Germany Article no.	
	<b>LBSOP0582DS</b>	<b>LBOP0582DS</b>	<b>KBSOP0582D</b>	<b>KBOP0582D</b>	<b>KROP0582D</b>			

OPEL

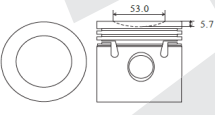

## GASOLINE

ENGINE TYPE Motortyp Type de Moteur Tipo de motor Тип двигателя	LINER KIT Liner Kit Kit de Chemise Camisas de los cilindros лайнер комплект	CYL. LINER Zylinderlaufbuchse Chemise Camisas de los cilindros втулка цилиндра	PISTON + RINGS Kolben + Ringe Piston + Segments Pistón Set Поршень и кольца		PISTON SET Kolben Set Set de Piston Pistón Set поршневой	RINGS SET Kolben Set Segments de Piston Anillos Set кольца	PIN Pin Axe Perno Пин	
<b>HILLMAN HUNTER</b>			Length:	82.7		Top:	2.0	Ø: 23.8 Length: 70.5
			Outside Ø:	47.0		2nd:	2.0	
			Flange Ø:	-9.0		3rd:	4.0	
			flange depth			1st oil:		
<b>4 Cyl</b> <b>81.54 mm Bore Ø</b> <b>1,725 cc</b>								
								
NM-Germany Article no. Artikelnummer/ Modelo Número / статья НОМЕР	NM-Germany Article no.	NM-Germany Article no.	Reference no.:		Reference no.:	Reference no.:	Reference no.:	O-RING
			<b>K-92493600</b> <b>M-0712700</b>			<b>M-07127N0</b> <b>M-PS1097</b>		
			<b>KBSPY40583G</b>	<b>KBPY40583G</b>		<b>KRPY40583G</b>		

## GASOLINE

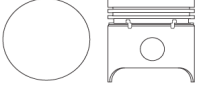

ENGINE TYPE Motortyp Type de Moteur Tipo de motor Тип двигателя	LINER KIT Liner Kit Kit de Chemise Camisas de los cilindros лайнер комплект	CYL. LINER Zylinderlaufbuchse Chemise Camisas de los cilindros втулка цилиндра	PISTON + RINGS Kolben + Ringe Piston + Segments Pistón Set Поршень и кольца		PISTON SET Kolben Set Set de Piston Pistón Set поршневой	RINGS SET Kolben Set Segments de Piston Anillos Set кольца	PIN Pin Axe Perno Пин	
<b>HILLMAN HUNTER</b>			Length:	82.5		Top:	2.0	Ø: 23.8 Length: 69.8
			Outside Ø:	46.9		2nd:	2.0	
			Flange Ø:	-5.7		3rd:	4.0	
			flange depth			1st oil:		
<b>4 Cyl</b> <b>81.54 mm Bore Ø</b> <b>1,725 cc</b>								
								
NM-Germany Article no. Artikelnummer/ Modelo Número / статья НОМЕР	NM-Germany Article no.	NM-Germany Article no.	Reference no.:		Reference no.:	Reference no.:	Reference no.:	O-RING
						<b>M-07127N0</b> <b>M-PS1097</b>		
			<b>KBSPY40584G</b>	<b>KBPY40584G</b>		<b>KRPY40584G</b>		

## GASOLINE

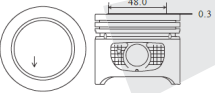

ENGINE TYPE Motortyp Type de Moteur Tipo de motor Тип двигателя	LINER KIT Liner Kit Kit de Chemise Camisas de los cilindros лайнер комплект	CYL. LINER Zylinderlaufbuchse Chemise Camisas de los cilindros втулка цилиндра	PISTON + RINGS Kolben + Ringe Piston + Segments Pistón Set Поршень и кольца	PISTON SET Kolben Set Set de Piston Pistón Set поршневой	RINGS SET Kolben Set Segments de Piston Anillos Set кольца	PIN Pin Axe Perno Пин	
<b>XV 3 XV 5 XV 8</b> 4 Cyl 70.0 mm Bore Ø 954 cc  	<b>K-92511960 M-0390790</b>	Length: 122.0 Outside Ø: 77.0 Flange Ø: 83.3 collar depth 84.9	Length: 73.3 Comp: 44.55 Height: 0		Top: 2.0 2nd: 2.0 3rd: 4.0 1st oil: 2nd oil:	Ø: 19.5 Length: 62.0	
		<b>Reference no.:</b>		<b>Reference no.:</b>	<b>Reference no.:</b>	<b>Reference no.:</b>	<b>O-RING</b>
		<b>K-88651110 M-039WN01</b>		<b>K-92511600 M-0390700</b>		<b>A-R66100 G-0831730000 M-03907N0</b>	<b>ORPG40593G</b>
NM-Germany Article no. Artikelnummer/ Modelo Número / статья НОМЕР	NM-Germany Article no.	NM-Germany Article no.	NM-Germany Article no.	NM-Germany Article no.	NM-Germany Article no.	NM-Germany Article no.	
	<b>LBSPG40593GF</b>	<b>LBPG40593GF</b>	<b>KBSPG40593G</b>	<b>KBPG40593G</b>	<b>KRPG40593G</b>		

PEUGEOT

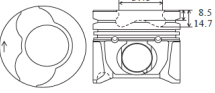

## GASOLINE

ENGINE TYPE Motortyp Type de Moteur Tipo de motor Тип двигателя	LINER KIT Liner Kit Kit de Chemise Camisas de los cilindros лайнер комплект	CYL. LINER Zylinderlaufbuchse Chemise Camisas de los cilindros втулка цилиндра	PISTON + RINGS Kolben + Ringe Piston + Segments Pistón Set Поршень и кольца	PISTON SET Kolben Set Set de Piston Pistón Set поршневой	RINGS SET Kolben Set Segments de Piston Anillos Set кольца	PIN Pin Axe Perno Пин	
<b>TU 9</b> 4 Cyl 70.0 mm Bore Ø 954 cc  	<b>A-SA2527 M-0396090</b>	Length: 122.0 Outside Ø: 79.5 Flange Ø: 89.8 collar depth 85.0	Length: 58.3 Comp: 34.0 Height: 0.3		Top: 1.5 2nd: 1.5 3rd: 3.0 1st oil: 2nd oil:	Ø: 18.0 Length: 53.0	
		<b>Reference no.:</b>		<b>Reference no.:</b>	<b>Reference no.:</b>	<b>Reference no.:</b>	<b>O-RING</b>
		<b>M-039WN27</b>		<b>A-PI4261300 K-91388600 M-0396000</b>		<b>A-R46910 A-R60850 G-0815420000 M-00726N0</b>	<b>ORPG40594G</b>
NM-Germany Article no. Artikelnummer/ Modelo Número / статья НОМЕР	NM-Germany Article no.	NM-Germany Article no.	NM-Germany Article no.	NM-Germany Article no.	NM-Germany Article no.	NM-Germany Article no.	
	<b>LBSPG40594GF</b>	<b>LBPG40594GF</b>	<b>KBSPG40594G</b>	<b>KBPG40594G</b>	<b>KRPG40594G</b>		

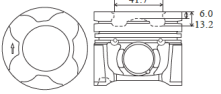

## GASOLINE

ENGINE TYPE Motortyp Type de Moteur Tipo de motor Тип двигателя	LINER KIT Liner Kit Kit de Chemise Camisas de los cilindros лайнер комплект	CYL. LINER Zylinderlaufbuchse Chemise Camisas de los cilindros втулка цилиндра	PISTON + RINGS Kolben + Ringe Piston + Segments Pistón Set Поршень и кольца	PISTON SET Kolben Set Set de Piston Pistón Set поршневой	RINGS SET Kolben Set Segments de Piston Anillos Set кольца	PIN Pin Axe Perno Пин	
<b>DV 4 TD DV 4 TED</b> 4 Cyl 73.7 mm Bore Ø 1,398 cc  		Length: 137.0 Outside Ø: 76.78 Flange Ø: 78.7 flange depth 4.0	Length: 65.44 Comp: 42.94 Height: -8.5 -14.7	alfin skirt MOS2 treated fits tapered con. rod	Top: 2.5 double key- stone 2nd: 1.95 3rd: 2.5 1st oil: 2nd oil:	Ø: 25.0 Length: 60.0	
		<b>Reference no.:</b>		<b>Reference no.:</b>	<b>Reference no.:</b>	<b>Reference no.:</b>	<b>O-RING</b>
				<b>A-A354118 K-40469600 M-0400300 N-8713530000</b>	<b>0628 N7</b>	<b>A-R66770 G-0813530000 K-800046040000 M-04005N0</b>	
NM-Germany Article no. Artikelnummer/ Modelo Número / статья НОМЕР	NM-Germany Article no.	NM-Germany Article no.	NM-Germany Article no.	NM-Germany Article no.	NM-Germany Article no.	NM-Germany Article no.	
	<b>LBSPG40595GSA</b>	<b>LBPG40595GSA</b>	<b>KBSPG40595GA</b>	<b>KBPG40595GA</b>	<b>KRPG40595GA</b>		



**DIESEL**

ENGINE TYPE	LINER KIT	CYL. LINER	PISTON + RINGS			PISTON SET	RINGS SET	PIN
Motortyp Type de Moteur Tipo de motor Тип двигателя	Liner Kit Kit de Chemise Camisas de los cilindros лайнер комплект	Zylinderlaufbuchse Chemise Camisas de los cilindros втулка цилиндра	Kolben + Ringe Piston + Segments Pistón Set Поршень и кольца			Kolben Set Set de Piston Pistón Set поршневой	Kolben Set Segments de Piston Anillos Set кольца	Pin Axe Perno Пин
<b>DV 6 ATED4</b> <b>DV 6 TED4</b> 4 Cyl 75.0 mm Bore Ø 1,560 cc 	<b>(A)</b> consists of (C)  <b>(B)</b> consists of (D)	Length: 146.0    146.0	Length: 65.3			alfin and with oil gallery skirt MOS2 treated fits tapered con. rod	Top: 3.0 double keystone 2nd: 2.0 3rd: 1st oil: 2.5 2nd oil:	Ø: 26.0 Length: 61.0
		Outside Ø: 78.0    78.0 Flange Ø: 79.0 flange depth 4.0	Comp: 41.7	Height: -6.0				
		Reference no.:	Reference no.:	Reference no.:	Reference no.:	O-RING		
			<b>A-A354125</b> <b>K-40179600</b> <b>M-0400600</b> <b>N-8742400000</b>	<b>0628 R4</b>	<b>G-0842400000</b> <b>K-800054940000</b> <b>M-04006N0</b>			
NM-Germany Article no. Artikelnummer/ Modelo Número / статья НОМЕР	NM-Germany Article no.	NM-Germany Article no.	NM-Germany Article no.	NM-Germany Article no.	NM-Germany Article no.	NM-Germany Article no.	NM-Germany Article no.	NM-Germany Article no.
	LBSPG40598DPA(A) LBSPG40598DSA(B)	LBPG40598DPA (C) LBPG40598DSA (D)	KBSPG40598DA	KBPG40597G	KRPG40597G			

**GASOLINE**

ENGINE TYPE	LINER KIT	CYL. LINER	PISTON + RINGS			PISTON SET	RINGS SET	PIN
Motortyp Type de Moteur Tipo de motor Тип двигателя	Liner Kit Kit de Chemise Camisas de los cilindros лайнер комплект	Zylinderlaufbuchse Chemise Camisas de los cilindros втулка цилиндра	Kolben + Ringe Piston + Segments Pistón Set Поршень и кольца			Kolben Set Set de Piston Pistón Set поршневой	Kolben Set Segments de Piston Anillos Set кольца	Pin Axe Perno Пин
<b>TU 32 TU 3A</b> <b>TU 3JP/MC</b> 4 Cyl 75.0 mm Bore Ø 1,361 cc 	<b>A-SA2531</b> <b>K-94356960</b> <b>K-94356971</b> <b>M-0396490</b>	Length: 135.4	Length: 64.0			Top: 1.75 2nd: 2.0 3rd: 1st oil: 3.0 2nd oil:	Ø: 19.5 Length: 62.0	
		Outside Ø: 79.5 Flange Ø: 89.2 collar depth 90.0	Comp: 40.4	Height: -1.0				
		Reference no.:	Reference no.:	Reference no.:	Reference no.:	O-RING		
		<b>K-89322110</b> <b>K-89584110</b> <b>M-021WN26</b>	<b>K-94356600</b> <b>K-94356700</b> <b>M-0396400</b>		<b>G-0815440000</b> <b>K-800002941000</b> <b>M-03964N0</b>	<b>ORPG40597G</b>		
NM-Germany Article no. Artikelnummer/ Modelo Número / статья НОМЕР	NM-Germany Article no.	NM-Germany Article no.	NM-Germany Article no.	NM-Germany Article no.	NM-Germany Article no.	NM-Germany Article no.	NM-Germany Article no.	
	LBSPG40597GF	LBPG40597GF	KBSPG40597G	KBPG40597G	KRPG40597G			

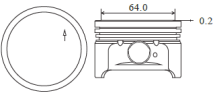
**GASOLINE**

ENGINE TYPE	LINER KIT	CYL. LINER	PISTON + RINGS			PISTON SET	RINGS SET	PIN
Motortyp Type de Moteur Tipo de motor Тип двигателя	Liner Kit Kit de Chemise Camisas de los cilindros лайнер комплект	Zylinderlaufbuchse Chemise Camisas de los cilindros втулка цилиндра	Kolben + Ringe Piston + Segments Pistón Set Поршень и кольца			Kolben Set Set de Piston Pistón Set поршневой	Kolben Set Segments de Piston Anillos Set кольца	Pin Axe Perno Пин
<b>TU 3 JP L4</b> 4 Cyl 75.0 mm Bore Ø 1,361 cc 	<b>M-0400290</b>	Length: 135.4	Length: 49.0			Top: 1.5 2nd: 1.5 3rd: 1st oil: 2.5 2nd oil:	Ø: 17.98 Length: 55.0	
		Outside Ø: 79.5 Flange Ø: 89.2 collar depth 90.0	Comp: 27.8	Height: 0.2				
		Reference no.:	Reference no.:	Reference no.:	Reference no.:	O-RING		
		<b>K-89322110</b> <b>K-89584110</b> <b>M-021WN26</b>	<b>A-24225</b> <b>M-0400200</b> <b>N-8713890030</b>		<b>A-R67020</b> <b>G-0813890000</b> <b>K-800043940000</b> <b>K-800043941000</b> <b>M-04002N0</b>	<b>ORPG40598G</b>		
NM-Germany Article no. Artikelnummer/ Modelo Número / статья НОМЕР	NM-Germany Article no.	NM-Germany Article no.	NM-Germany Article no.	NM-Germany Article no.	NM-Germany Article no.	NM-Germany Article no.	NM-Germany Article no.	
	LBSPG40598GF	LBPG40598GF	KBSPG40598G	KBPG40598G	KRPG40598G			

## DIESEL

ENGINE TYPE Motortyp Type de Moteur Tipo de motor Тип двигателя	LINER KIT Liner Kit Kit de Chemise Camisas de los cilindros лайнер комплект	CYL. LINER Zylinderlaufbuchse Chemise Camisas de los cilindros втулка цилиндра	PISTON + RINGS Kolben + Ringe Piston + Segments Pistón Set Поршень и кольца		PISTON SET Kolben Set Set de Piston Pistón Set поршневой	RINGS SET Kolben Set Segments de Piston Anillos Set кольца	PIN Pin Axe Perno Пин
<b>TUD 5</b> 4 Cyl 77.0 mm Bore Ø 1,527 cc		Length: 66.32 Outside Ø: 83.0 Flange Ø: 100.0 flange depth 97.4	Length:	66.32	66.32	Top: 2.0 2nd: 1.75 3rd: 3.0 1st oil: 2nd oil:	Ø: 23.0 Length: 60.0
			Comp:	40.37	40.1		
			Height:	-1.5	-1.5		
			STD	O/S			
			Reference no.:	Reference no.:	Reference no.:	Reference no.:	O-RING
				<b>K-94642700</b> <b>M-0390100</b>		<b>A-R49960</b> <b>G-0832580000</b> <b>K-800036541000</b> <b>M-03901N0</b>	
NM-Germany Article no. Artikelnummer/ Modelo Número / статья НОМЕР	NM-Germany Article no.	NM-Germany Article no.	NM-Germany Article no.	NM-Germany Article no.	NM-Germany Article no.	NM-Germany Article no.	NM-Germany Article no.
			<b>KBSPG40599D</b>	<b>KBPG40599D</b>	<b>KRPG40599D</b>		

PEUGEOT



## GASOLINE

ENGINE TYPE Motortyp Type de Moteur Tipo de motor Тип двигателя	LINER KIT Liner Kit Kit de Chemise Camisas de los cilindros лайнер комплект	CYL. LINER Zylinderlaufbuchse Chemise Camisas de los cilindros втулка цилиндра	PISTON + RINGS Kolben + Ringe Piston + Segments Pistón Set Поршень и кольца		PISTON SET Kolben Set Set de Piston Pistón Set поршневой	RINGS SET Kolben Set Segments de Piston Anillos Set кольца	PIN Pin Axe Perno Пин
<b>305R</b> 4 Cyl 78.0 mm Bore Ø 1,472 cc		Length: 133.5 Outside Ø: 83.0 Flange Ø: 100.0 collar depth 97.4	Length:	72.5		Top: 1.75 2nd: 2.0 3rd: 4.0 1st oil: 2nd oil:	Ø: 20.5 Length: 68.0
			Comp:	36.2			
			Height:	0.3			
			Reference no.:	Reference no.:	Reference no.:	Reference no.:	O-RING
				<b>K-89027110</b> <b>M-039WN18</b>		<b>A-R66130</b> <b>G-0832010000</b> <b>M-03969N0</b> <b>N-80022340000</b>	<b>ORPG40600G</b>
NM-Germany Article no. Artikelnummer/ Modelo Número / статья НОМЕР	NM-Germany Article no.	NM-Germany Article no.	NM-Germany Article no.	NM-Germany Article no.	NM-Germany Article no.	NM-Germany Article no.	NM-Germany Article no.
	<b>LBSPG40600GF</b>	<b>LBPG40600GF</b>	<b>KBSPG40600G</b>	<b>KBPG40600G</b>	<b>KRPG40600G</b>		

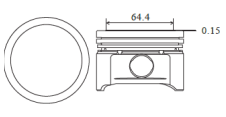

## GASOLINE

ENGINE TYPE Motortyp Type de Moteur Tipo de motor Тип двигателя	LINER KIT Liner Kit Kit de Chemise Camisas de los cilindros лайнер комплект	CYL. LINER Zylinderlaufbuchse Chemise Camisas de los cilindros втулка цилиндра	PISTON + RINGS Kolben + Ringe Piston + Segments Pistón Set Поршень и кольца		PISTON SET Kolben Set Set de Piston Pistón Set поршневой	RINGS SET Kolben Set Segments de Piston Anillos Set кольца	PIN Pin Axe Perno Пин
<b>XL 5 XL 5S XL 5TR</b> 4 Cyl 78.0 mm Bore Ø 1,290 cc	<b>K-93272960</b> <b>M-0396990</b>	Length: 133.5 Outside Ø: 83.0 Flange Ø: 100.0 collar depth 97.4	Length:	72.0		Top: 1.75 2nd: 2.0 3rd: 4.0 1st oil: 2nd oil:	Ø: 20.5 Length: 44.5
			Comp:	36.0			
			Height:	0			
			Reference no.:	Reference no.:	Reference no.:	Reference no.:	O-RING
				<b>K-89027110</b> <b>M-039WN18</b>	<b>K-93272600</b> <b>M-0396900</b>	<b>A-R66130</b> <b>G-0832010000</b> <b>M-03969N0</b> <b>N-80022340000</b>	<b>ORPG40601G</b>
NM-Germany Article no. Artikelnummer/ Modelo Número / статья НОМЕР	NM-Germany Article no.	NM-Germany Article no.	NM-Germany Article no.	NM-Germany Article no.	NM-Germany Article no.	NM-Germany Article no.	NM-Germany Article no.
	<b>LBSPG40601GF</b>	<b>LBPG40601GF</b>	<b>KBSPG40601G</b>	<b>KBPG40601G</b>	<b>KRPG40601G</b>		

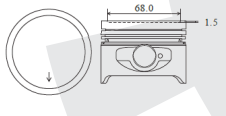

**GASOLINE**

ENGINE TYPE Motortyp Type de Moteur Tipo de motor Тип двигателя	LINER KIT Liner Kit Kit de Chemise Camisas de los cilindros лайнер комплект	CYL. LINER Zylinderlaufbuchse Chemise Camisas de los cilindros втулка цилиндра	PISTON + RINGS Kolben + Ringe Piston + Segments Pistón Set Поршень и кольца	PISTON SET Kolben Set Set de Piston Pistón Set поршневой	RINGS SET Kolben Set Segments de Piston Anillos Set кольца	PIN Pin Axe Perno Пин	
<b>TU 5 JP 4</b> 4 Cyl 78.5 mm Bore Ø 1,587 cc 		Length:	Length:		Top:	Ø: 19.5 Length: 57.0	
		Outside Ø:	Comp:		2nd:		
		Flange Ø:	Height:		3rd:		
		flange depth			1st oil:		
			<b>Reference no.:</b>	<b>Reference no.:</b>	<b>Reference no.:</b>	<b>Reference no.:</b>	<b>O-RING</b>
			<b>K-40161600</b> <b>M-0400400</b> <b>M-S44000</b>	<b>0628 N0 M-E44000</b> <b>M-P9126</b>	<b>A-R67250</b> <b>G-0813940000</b> <b>K-800050940000</b> <b>M-04004N0</b> <b>M-A44500</b>		
NM-Germany Article no. Artikelnummer/ Modelo Número / статья НОМЕР	NM-Germany Article no.	NM-Germany Article no.	NM-Germany Article no.	NM-Germany Article no.	NM-Germany Article no.	NM-Germany Article no.	NM-Germany Article no.
			<b>KBSPG40602G</b>	<b>KBPG40602G</b>	<b>KRPG40602G</b>		

**GASOLINE**

ENGINE TYPE Motortyp Type de Moteur Tipo de motor Тип двигателя	LINER KIT Liner Kit Kit de Chemise Camisas de los cilindros лайнер комплект	CYL. LINER Zylinderlaufbuchse Chemise Camisas de los cilindros втулка цилиндра	PISTON + RINGS Kolben + Ringe Piston + Segments Pistón Set Поршень и кольца	PISTON SET Kolben Set Set de Piston Pistón Set поршневой	RINGS SET Kolben Set Segments de Piston Anillos Set кольца	PIN Pin Axe Perno Пин	
<b>TU 5 JP</b> 4 Cyl 78.5 mm Bore Ø 1,587 cc 		Length:	Length:		Top:	Ø: 19.5 Length: 62.0	
		Outside Ø:	Comp:		2nd:		
		Flange Ø:	Height:		3rd:		
		flange depth			1st oil:		
			<b>Reference no.:</b>	<b>Reference no.:</b>	<b>Reference no.:</b>	<b>Reference no.:</b>	<b>O-RING</b>
			<b>M-0318800</b>	<b>0628 J0</b>	<b>G-0810380000</b> <b>M-04008V0</b>		
NM-Germany Article no. Artikelnummer/ Modelo Número / статья НОМЕР	NM-Germany Article no.	NM-Germany Article no.	NM-Germany Article no.	NM-Germany Article no.	NM-Germany Article no.	NM-Germany Article no.	NM-Germany Article no.
			<b>KBSPG40603G</b>	<b>KBPG40603G</b>	<b>KRPG40603G</b>		

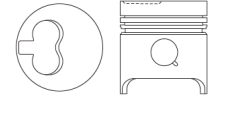
**GASOLINE**

ENGINE TYPE Motortyp Type de Moteur Tipo de motor Тип двигателя	LINER KIT Liner Kit Kit de Chemise Camisas de los cilindros лайнер комплект	CYL. LINER Zylinderlaufbuchse Chemise Camisas de los cilindros втулка цилиндра	PISTON + RINGS Kolben + Ringe Piston + Segments Pistón Set Поршень и кольца	PISTON SET Kolben Set Set de Piston Pistón Set поршневой	RINGS SET Kolben Set Segments de Piston Anillos Set кольца	PIN Pin Axe Perno Пин	
<b>XUD 7</b> 4 Cyl 80.0 mm Bore Ø 1,769 cc 	<b>K-93784960</b> <b>K-93784970</b> <b>M-0397890</b>	Length:	Length:		Top:	Ø: 25.0 Length: 69.5	
		Outside Ø:	Comp:		2nd:		
		Flange Ø:	Height:		3rd:		
		flange depth	4.5		1st oil:		
			<b>Reference no.:</b>	<b>Reference no.:</b>	<b>Reference no.:</b>	<b>Reference no.:</b>	<b>O-RING</b>
			<b>G-1402483000</b> <b>K-89316190</b> <b>M-039VW23</b>	<b>A-350705</b> <b>K-93784700</b> <b>M-0397800</b> <b>N-8732150010</b>	<b>0626 17</b> <b>0627 04</b> <b>0628 64</b> <b>0628 E1</b>	<b>A-R66400</b> <b>G-0832150000</b> <b>K-800003240000</b> <b>M-01154N0</b>	
NM-Germany Article no. Artikelnummer/ Modelo Número / статья НОМЕР	NM-Germany Article no.	NM-Germany Article no.	NM-Germany Article no.	NM-Germany Article no.	NM-Germany Article no.	NM-Germany Article no.	NM-Germany Article no.
	<b>LBSPG40604GS</b>	<b>LBPG40604GS</b>	<b>KBSPG40604G</b>	<b>KBPG40604G</b>	<b>KRPG40604G</b>		



## GASOLINE

ENGINE TYPE Motortyp Type de Moteur Tipo de motor Тип двигателя	LINER KIT Liner Kit Kit de Chemise Camisas de los cilindros лайнер комплект	CYL. LINER Zylinderlaufbuchse Chemise Camisas de los cilindros втулка цилиндра	PISTON + RINGS Kolben + Ringe Piston + Segments Pistón Set Поршень и кольца		PISTON SET Kolben Set Set de Piston Pistón Set поршневой	RINGS SET Kolben Set Segments de Piston Anillos Set кольца	PIN Pin Axe Perno Пин
<b>XUD 7TE XUD 7TEY</b> 4 Cyl 80.0 mm Bore Ø 1,769 cc	<b>K-90354960</b> <b>M-0397390</b>	Length: 154.0	Length: 84.5		head anodized	Top: 3.0	Ø: 28.0 Length: 68.0
		Outside Ø: 83.0	Comp: 46.8			double key-stone	
		Flange Ø: 86.0	Height: -1.85			2nd: 2.0	
flange depth 4.5					3rd: 3.0	1st oil: 3.0	2nd oil:
		<b>Reference no.:</b>	<b>Reference no.:</b>	<b>Reference no.:</b>	<b>Reference no.:</b>	<b>O-RING</b>	
		<b>G-1402483000</b> <b>K-89316190</b> <b>M-039WV23</b>	<b>A-A350536</b> <b>K-90354600</b> <b>M-0397300</b> <b>N-8732360000</b>	<b>0627 24</b> <b>0628 19</b> <b>0628 37</b>	<b>0640 C0</b> <b>A-R49910</b> <b>G-0832360000</b> <b>K-800003340000</b> <b>M-03973N0</b>		
NM-Germany Article no. Artikelnummer/ Modelo Número / статья НОМЕР	NM-Germany Article no.	NM-Germany Article no.	NM-Germany Article no.	NM-Germany Article no.	NM-Germany Article no.	NM-Germany Article no.	
	<b>LBSPG40605GS</b>	<b>LBPG40605GS</b>	<b>KBSPG40605G</b>	<b>KBPG40605G</b>	<b>KRPG40605G</b>		

PEUGEOT

## GASOLINE

ENGINE TYPE Motortyp Type de Moteur Tipo de motor Тип двигателя	LINER KIT Liner Kit Kit de Chemise Camisas de los cilindros лайнер комплект	CYL. LINER Zylinderlaufbuchse Chemise Camisas de los cilindros втулка цилиндра	PISTON + RINGS Kolben + Ringe Piston + Segments Pistón Set Поршень и кольца		PISTON SET Kolben Set Set de Piston Pistón Set поршневой	RINGS SET Kolben Set Segments de Piston Anillos Set кольца	PIN Pin Axe Perno Пин
<b>DW8 DW8 B XUD 9AY</b> 4 Cyl 82.2 mm Bore Ø 1,868 cc	<b>K-99877960</b>		STD	O/S		Top: 2.0	Ø: 25.0 Length: 66.0
		Length: 154.0	Length: 77.7	77.45		2nd: 2.0	
		Outside Ø: 86.0	Comp: 46.8	46.55		3rd: 3.0	
flange depth		Height: -1.2	-1.2		1st oil: 3.0	2nd oil:	
		<b>Reference no.:</b>	<b>Reference no.:</b>	<b>Reference no.:</b>	<b>Reference no.:</b>	<b>O-RING</b>	
		<b>K-89592190</b>	<b>A-350544</b> <b>K-99877600</b> <b>M-0400100</b> <b>N-8710400000</b>	<b>0628 J2</b>	<b>0640 PO A-R60230</b> <b>G-0810400000</b> <b>K-800045840000</b> <b>M-04001N0</b>		
NM-Germany Article no. Artikelnummer/ Modelo Número / статья НОМЕР	NM-Germany Article no.	NM-Germany Article no.	NM-Germany Article no.	NM-Germany Article no.	NM-Germany Article no.	NM-Germany Article no.	
	<b>LBSPG40606GP</b>	<b>LBPG40606GP</b>	<b>KBSPG40606G</b>	<b>KBPG40606G</b>	<b>KRPG40606G</b>		

## DIESEL

ENGINE TYPE Motortyp Type de Moteur Tipo de motor Тип двигателя	LINER KIT Liner Kit Kit de Chemise Camisas de los cilindros лайнер комплект	CYL. LINER Zylinderlaufbuchse Chemise Camisas de los cilindros втулка цилиндра	PISTON + RINGS Kolben + Ringe Piston + Segments Pistón Set Поршень и кольца		PISTON SET Kolben Set Set de Piston Pistón Set поршневой	RINGS SET Kolben Set Segments de Piston Anillos Set кольца	PIN Pin Axe Perno Пин	
<b>XUD 9/9A XUD 9B/9K XUD 9Y</b> 4 Cyl 83.0 mm Bore Ø 1,905 cc	<b>(A)</b> <b>K-93648970</b> <b>M-0392490</b> consists of (C) <b>(B)</b> <b>M-0392491</b> consists of (D)	(C) (D)				Top: 2.0	Ø: 25.0 Length: 72.0	
		Length: 153.5	153.5	Length: 84.3				2nd: 2.0
		Outside Ø: 86.0	86.0	Comp: 46.8				3rd: 2.0
Flange Ø: 89.0	89.0	Height: -2.2			1st oil: 3.0	2nd oil:		
flange depth 4.8								
		<b>Reference no.:</b>	<b>Reference no.:</b>	<b>Reference no.:</b>	<b>Reference no.:</b>	<b>O-RING</b>		
		<b>(C)</b> <b>K-93184190</b> <b>M-039WV21</b>	<b>(D)</b> <b>M-039WV32</b>	<b>A-350709</b> <b>K-93648700</b> <b>M-0392400</b> <b>N-8715200010</b>	<b>0627 07</b> <b>0628 15</b> <b>0628 E3</b>	<b>0640 43</b> <b>0640 46</b> <b>0640 81</b> <b>A-R66390</b> <b>G-0815200000</b> <b>K-800003740000</b> <b>M-03924N0</b>		
NM-Germany Article no. Artikelnummer/ Modelo Número / статья НОМЕР	NM-Germany Article no.	NM-Germany Article no.	NM-Germany Article no.	NM-Germany Article no.	NM-Germany Article no.	NM-Germany Article no.		
	<b>LBSPG40607DP(A)</b> <b>LBSPG40607DS(B)</b>	<b>LBPG40607DP(C)</b> <b>LBPG40607DP(D)</b>	<b>KBSPG40607D</b>	<b>KBPG40607D</b>	<b>KRPG40607D</b>			

**DIESEL**

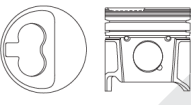
ENGINE TYPE Motortyp Type de Moteur Tipo de motor Тип двигателя	LINER KIT Liner Kit Kit de Chemise Camisas de los cilindros лайнер комплект	CYL. LINER Zylinderlaufbuchse Chemise Camisas de los cilindros втулка цилиндра	PISTON + RINGS Kolben + Ringe Piston + Segments Pistón Set Поршень и кольца		PISTON SET Kolben Set Set de Piston Pistón Set поршень	RINGS SET Kolben Set Segments de Piston Anillos Set кольца	PIN Pin Axe Perno Пин
<b>XUD 9 AF/BSDBTF</b> <b>XUD 9 SD/SE/TE/TF</b> <b>XUD 9 TFU/UTF</b> 4 Cyl 83.0 mm Bore Ø 1,905 cc		Length: 46.8 Outside Ø: Flange Ø: flange depth	STD	O/S	alfin head anodized skirt MOS2 treated fits tapered con. rod	Top: 3.0 double key-stone 2nd: 2.0 3rd: 1st oil: 3.0 2nd oil:	Ø: 28.0 Length: 68.0
			Length: 79.3	79.3			
			Reference no.:	Reference no.:	Reference no.:	Reference no.:	O-RING
				A-A350520 K-94786700 M-0399600 N-8710550000		A-R60140 G-0810550000 M-03996N0	
NM-Germany Article no. Artikelnummer/ Modelo Número / статья НОМЕР	NM-Germany Article no.	NM-Germany Article no.	NM-Germany Article no.	NM-Germany Article no.	NM-Germany Article no.	NM-Germany Article no.	NM-Germany Article no.
			KBSPG40608DA	KBPG40608DA	KRPG40608DA		



**GASOLINE**

ENGINE TYPE Motortyp Type de Moteur Tipo de motor Тип двигателя	LINER KIT Liner Kit Kit de Chemise Camisas de los cilindros лайнер комплект	CYL. LINER Zylinderlaufbuchse Chemise Camisas de los cilindros втулка цилиндра	PISTON + RINGS Kolben + Ringe Piston + Segments Pistón Set Поршень и кольца		PISTON SET Kolben Set Set de Piston Pistón Set поршень	RINGS SET Kolben Set Segments de Piston Anillos Set кольца	PIN Pin Axe Perno Пин
<b>XU 52 C</b> 4 Cyl 83.0 mm Bore Ø 1,581 cc	<b>A-SA2518</b> <b>K-91017960</b> <b>M-0398190</b> <b>N-8915120000</b>	Length: 141.0 Outside Ø: 88.6 Flange Ø: 97.0 collar depth 95.19	Length: 67.5			Top: 1.75 2nd: 1.75 3rd: 1st oil: 4.0 2nd oil:	Ø: 22.0 Length: 62.0
			Comp: 37.5	Height: -2.8			
			Reference no.:	Reference no.:	Reference no.:	Reference no.:	O-RING
				A-SJ4327 G-1463491000 K-89301110 M-039WN24	K-91017600 M-0398100	A-R60940 G-0815120000 K-800003640000 M-03976N0	ORPG40609G
NM-Germany Article no. Artikelnummer/ Modelo Número / статья НОМЕР	NM-Germany Article no.	NM-Germany Article no.	NM-Germany Article no.	NM-Germany Article no.	NM-Germany Article no.	NM-Germany Article no.	NM-Germany Article no.
	LBSPG40609GF	LBPB40609GF	KBSPG40609G	KBPG40609G	KRPG40609G		

**GASOLINE**

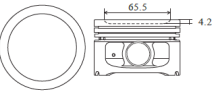

ENGINE TYPE Motortyp Type de Moteur Tipo de motor Тип двигателя	LINER KIT Liner Kit Kit de Chemise Camisas de los cilindros лайнер комплект	CYL. LINER Zylinderlaufbuchse Chemise Camisas de los cilindros втулка цилиндра	PISTON + RINGS Kolben + Ringe Piston + Segments Pistón Set Поршень и кольца		PISTON SET Kolben Set Set de Piston Pistón Set поршень	RINGS SET Kolben Set Segments de Piston Anillos Set кольца	PIN Pin Axe Perno Пин
<b>XJ 5 J</b> <b>XU 9 2 C</b> <b>XU 9 JA</b> 4 Cyl 83.0 mm Bore Ø 1,580 cc 1,905 cc	<b>A-SA2517</b> <b>K-90382970</b> <b>M-0397990</b> <b>N-8932240000</b>	Length: 141.0 Outside Ø: 88.6 Flange Ø: 97.0 collar depth 95.19	Length: 67.5			Top: 1.5 2nd: 1.5 3rd: 1st oil: 4.0 2nd oil:	Ø: 22.0 Length: 62.0
			Comp: 37.5	Height: -9.0			
			Reference no.:	Reference no.:	Reference no.:	Reference no.:	O-RING
				A-SJ4327 G-1463491000 K-89301110 M-039WN24	K-90382700 M-0397900	A-R60950 G-0832240000 K-800003541000 M-03980N0	ORPG40610G
NM-Germany Article no. Artikelnummer/ Modelo Número / статья НОМЕР	NM-Germany Article no.	NM-Germany Article no.	NM-Germany Article no.	NM-Germany Article no.	NM-Germany Article no.	NM-Germany Article no.	NM-Germany Article no.
	LBSPG40610GF	LBPB40610GF	KBSPG40610G	KBPG40610G	KRPG40610G		

**GASOLINE**

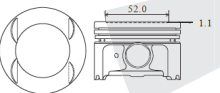

ENGINE TYPE Motortyp Type de Moteur Tipo de motor Тип двигателя	LINER KIT Liner Kit Kit de Chemise Camisas de los cilindros лайнер комплект	CYL. LINER Zylinderlaufbuchse Chemise Camisas de los cilindros втулка цилиндра	PISTON + RINGS Kolben + Ringe Piston + Segments Pistón Set Поршень и кольца			PISTON SET Kolben Set Set de Piston Pistón Set поршневой	RINGS SET Kolben Set Segments de Piston Anillos Set кольца	PIN Pin Axe Perno Пин
<b>XU 5 JP</b> <b>XU 7 JB/JP XU 7</b> <b>JP Z</b> 4 Cyl 83.0 mm Bore Ø 1,580 cc 1,762 cc 	<b>A-SA2423</b> <b>K-94351960</b> <b>K-94351970</b> <b>M-0398792</b>	Length: 141.0 Outside Ø: 88.6 Flange Ø: 97.0 collar depth 95.19	Length: 53.4 Comp: 33.4 Height: -4.2			Top: 1.5 2nd: 1.5 3rd: 3.0 1st oil: 2nd oil:	Ø: 22.0 Length: 62.0	
		Reference no.:		Reference no.:	Reference no.:	Reference no.:	O-RING	
		<b>A-SJ4327</b> <b>G-1463491000</b> <b>K-89301110</b> <b>M-039WN24</b>		<b>A-24142</b> <b>K-94351600</b> <b>K-94351700</b> <b>M-0398700</b>			<b>A-R60190</b> <b>G-0832340000</b> <b>K-800003441000</b> <b>M-03982V0</b> <b>T-50014</b>	<b>ORPG40611G</b>
NM-Germany Article no. Artikelnummer/ Modelo Número / статья НОМЕР	NM-Germany Article no.	NM-Germany Article no.	NM-Germany Article no.	NM-Germany Article no.	NM-Germany Article no.	NM-Germany Article no.	NM-Germany Article no.	
	<b>LBSPG40611GF</b>	<b>LBPG40611GF</b>	<b>KBSPG40611G</b>	<b>KBPG40611G</b>	<b>KRPG40611G</b>			

PEUGEOT

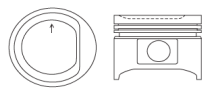

**GASOLINE**

ENGINE TYPE Motortyp Type de Moteur Tipo de motor Тип двигателя	LINER KIT Liner Kit Kit de Chemise Camisas de los cilindros лайнер комплект	CYL. LINER Zylinderlaufbuchse Chemise Camisas de los cilindros втулка цилиндра	PISTON + RINGS Kolben + Ringe Piston + Segments Pistón Set Поршень и кольца			PISTON SET Kolben Set Set de Piston Pistón Set поршневой	RINGS SET Kolben Set Segments de Piston Anillos Set кольца	PIN Pin Axe Perno Пин
<b>XU 7 JP4</b> 4 Cyl 83.0 mm Bore Ø 1,762 cc 	<b>K-94742970</b> <b>M-0396690</b>	Length: 141.0 Outside Ø: 88.6 Flange Ø: 97.0 collar depth 95.19	Length: 56.4 Comp: 33.4 Height: -1.1			Top: 1.5 2nd: 1.5 3rd: 3.0 1st oil: 2nd oil:	Ø: 22.0 Length: 62.0	
		Reference no.:		Reference no.:	Reference no.:	Reference no.:	O-RING	
		<b>A-SJ4327</b> <b>G-1463491000</b> <b>K-89301110</b> <b>M-039WN24</b>		<b>K-94742700</b> <b>M-0396600</b>			<b>A-R60190</b> <b>G-0832340000</b> <b>K-800003441000</b> <b>M-03982V0</b> <b>T-50014</b>	<b>ORPG40612G</b>
NM-Germany Article no. Artikelnummer/ Modelo Número / статья НОМЕР	NM-Germany Article no.	NM-Germany Article no.	NM-Germany Article no.	NM-Germany Article no.	NM-Germany Article no.	NM-Germany Article no.	NM-Germany Article no.	
	<b>LBSPG40612GF</b>	<b>LBPG40612GF</b>	<b>KBSPG40612G</b>	<b>KBPG40612G</b>	<b>KRPG40612G</b>			

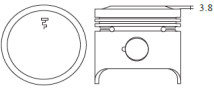

**GASOLINE**

ENGINE TYPE Motortyp Type de Moteur Tipo de motor Тип двигателя	LINER KIT Liner Kit Kit de Chemise Camisas de los cilindros лайнер комплект	CYL. LINER Zylinderlaufbuchse Chemise Camisas de los cilindros втулка цилиндра	PISTON + RINGS Kolben + Ringe Piston + Segments Pistón Set Поршень и кольца			PISTON SET Kolben Set Set de Piston Pistón Set поршневой	RINGS SET Kolben Set Segments de Piston Anillos Set кольца	PIN Pin Axe Perno Пин
<b>XU 5S</b> 4 Cyl 83.0 mm Bore Ø 1,580 cc 	<b>A-SA2518</b> <b>K-93846980</b> <b>M-0397692</b> <b>N-8915120000</b>	Length: 141.0 Outside Ø: 88.6 Flange Ø: 97.0 collar depth 95.19	Length: 67.5 Comp: 37.5 Height: -2.1			Top: 1.75 2nd: 1.75 3rd: 4.0 1st oil: 2nd oil:	Ø: 22.0 Length: 66.0	
		Reference no.:		Reference no.:	Reference no.:	Reference no.:	O-RING	
		<b>A-SJ4327</b> <b>G-1463491000</b> <b>K-89301110</b> <b>M-039WN24</b>		<b>K-93846800</b> <b>M-0397600</b>			<b>A-R60940</b> <b>G-0815120000</b> <b>K-800003640000</b> <b>M-03976N0</b>	<b>ORPG40613G</b>
NM-Germany Article no. Artikelnummer/ Modelo Número / статья НОМЕР	NM-Germany Article no.	NM-Germany Article no.	NM-Germany Article no.	NM-Germany Article no.	NM-Germany Article no.	NM-Germany Article no.	NM-Germany Article no.	
	<b>LBSPG40613GF</b>	<b>LBPG40613GF</b>	<b>KBSPG40613G</b>	<b>KBPG40613G</b>	<b>KRPG40613G</b>			

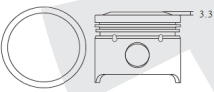

**GASOLINE**

ENGINE TYPE Motortyp Type de Moteur Tipo de motor Тип двигателя	LINER KIT Liner Kit Kit de Chemise Camisas de los cilindros лайнер комплект	CYL. LINER Zylinderlaufbuchse Chemise Camisas de los cilindros втулка цилиндра	PISTON + RINGS Kolben + Ringe Piston + Segments Pistón Set Поршень и кольца			PISTON SET Kolben Set Set de Piston Pistón Set поршневой	RINGS SET Kolben Set Segments de Piston Anillos Set кольца	PIN Pin Axe Perno Пин
<b>XC 7</b> 4 Cyl 84.0 mm Bore Ø 1,618 cc	<b>M-0393392</b>	Length: 135.5	Length: 79.1			Top: 2.0	Ø: 23.0 Length: 70.0	
		Outside Ø: 92.95	Comp: 41.4			2nd: 2.0		
		Flange Ø: 99.5	Height: 3.8			3rd: 4.5		
		collar depth 90.0				1st oil: 4.5		
			<b>Reference no.:</b>	<b>Reference no.:</b>	<b>Reference no.:</b>	<b>Reference no.:</b>	<b>O-RING</b>	
			<b>K-88634110</b> <b>M-039WN10</b>	<b>M-0393300</b>		<b>A-R66020</b> <b>G-0831290000</b> <b>M-03929N0</b>	<b>ORPG40614G</b>	
NM-Germany Article no. Artikelnummer/ Modelo Número / статья НОМЕР	NM-Germany Article no.	NM-Germany Article no.	NM-Germany Article no.	NM-Germany Article no.	NM-Germany Article no.	NM-Germany Article no.	NM-Germany Article no.	
	<b>LBSPG40614GF</b>	<b>LBPG40614GF</b>	<b>KBSPG40614G</b>	<b>KBPG40614G</b>	<b>KRPG40614G</b>			

**GASOLINE**

ENGINE TYPE Motortyp Type de Moteur Tipo de motor Тип двигателя	LINER KIT Liner Kit Kit de Chemise Camisas de los cilindros лайнер комплект	CYL. LINER Zylinderlaufbuchse Chemise Camisas de los cilindros втулка цилиндра	PISTON + RINGS Kolben + Ringe Piston + Segments Pistón Set Поршень и кольца			PISTON SET Kolben Set Set de Piston Pistón Set поршневой	RINGS SET Kolben Set Segments de Piston Anillos Set кольца	PIN Pin Axe Perno Пин
<b>XC 6</b> 4 Cyl 84.0 mm Bore Ø 1,618 cc	<b>M-0393492</b>	Length: 135.5	Length: 73.8			Top: 2.0	Ø: 23.0 Length: 70.0	
		Outside Ø: 92.95	Comp: 41.5			2nd: 2.0		
		Flange Ø: 99.5	Height: 3.3			3rd: 4.5		
		collar depth 90.0				1st oil: 4.5		
			<b>Reference no.:</b>	<b>Reference no.:</b>	<b>Reference no.:</b>	<b>Reference no.:</b>	<b>O-RING</b>	
			<b>K-88634110</b> <b>M-039WN10</b>	<b>K-91517700</b> <b>M-0393400</b>		<b>A-R66020</b> <b>G-0831290000</b> <b>M-03929N0</b>	<b>ORPG40615G</b>	
NM-Germany Article no. Artikelnummer/ Modelo Número / статья НОМЕР	NM-Germany Article no.	NM-Germany Article no.	NM-Germany Article no.	NM-Germany Article no.	NM-Germany Article no.	NM-Germany Article no.	NM-Germany Article no.	
	<b>LBSPG40615GF</b>	<b>LBPG40615GF</b>	<b>KBSPG40615G</b>	<b>KBPG40615G</b>	<b>KRPG40615G</b>			

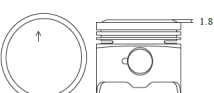
**GASOLINE**

ENGINE TYPE Motortyp Type de Moteur Tipo de motor Тип двигателя	LINER KIT Liner Kit Kit de Chemise Camisas de los cilindros лайнер комплект	CYL. LINER Zylinderlaufbuchse Chemise Camisas de los cilindros втулка цилиндра	PISTON + RINGS Kolben + Ringe Piston + Segments Pistón Set Поршень и кольца			PISTON SET Kolben Set Set de Piston Pistón Set поршневой	RINGS SET Kolben Set Segments de Piston Anillos Set кольца	PIN Pin Axe Perno Пин
<b>KF 6 XM</b> 4 Cyl 84.0 mm Bore Ø 1,796 cc	<b>M-0393292</b>	Length: 135.5	Length: 72.1			Top: 1.5	Ø: 23.0 Length: 70.0	
		Outside Ø: 92.95	Comp: 38.3			2nd: 2.0		
		Flange Ø: 99.5	Height: 1.8			3rd: 4.0		
		collar depth 90.0				1st oil: 4.0		
			<b>Reference no.:</b>	<b>Reference no.:</b>	<b>Reference no.:</b>	<b>Reference no.:</b>	<b>O-RING</b>	
			<b>K-88634110</b> <b>M-039WN10</b>	<b>K-91520600</b> <b>M-0393200</b>		<b>A-R66060</b> <b>G-0831530000</b> <b>K-800006640000</b> <b>M-03932N0</b>	<b>ORPG40616G</b>	
NM-Germany Article no. Artikelnummer/ Modelo Número / статья НОМЕР	NM-Germany Article no.	NM-Germany Article no.	NM-Germany Article no.	NM-Germany Article no.	NM-Germany Article no.	NM-Germany Article no.	NM-Germany Article no.	
	<b>LBSPG40616GF</b>	<b>LBPG40616GF</b>	<b>KBSPG40616G</b>	<b>KBPG40616G</b>	<b>KRPG40616G</b>			

## GASOLINE

ENGINE TYPE Motortyp Type de Moteur Tipo de motor Тип двигателя	LINER KIT Liner Kit Kit de Chemise Camisas de los cilindros лайнер комплект	CYL. LINER Zylinderlaufbuchse Chemise Camisas de los cilindros втулка цилиндра	PISTON + RINGS Kolben + Ringe Piston + Segments Pistón Set Поршень и кольца			PISTON SET Kolben Set Set de Piston Pistón Set поршневой	RINGS SET Kolben Set Segments de Piston Anillos Set кольца	PIN Pin Axe Perno Пин
<b>XM 7</b> <b>XM 7 P</b> <b>XM 7 T</b> 4 Cyl 84.0 mm Bore Ø 1,796 cc	<b>A-SA2549</b> <b>N-8931530000</b>	Length: 136.2	Length: 71.2			Top: 1.5	Ø: 23.0 Length: 70.0	
		Outside Ø: 93.0	Comp: 38.0			2nd: 2.0		
		Flange Ø: 99.2	Height: 0			3rd: 4.0		
		collar depth 90.0				1st oil: 4.0		
			<b>Reference no.:</b>	<b>Reference no.:</b>	<b>Reference no.:</b>	<b>Reference no.:</b>	<b>O-RING</b>	
			<b>G-1460667000</b>			<b>0640 23</b> <b>0640 83</b> <b>A-R66060</b> <b>G-0831530000</b> <b>K-8000066400 M-</b> <b>03932N0</b>		
NM-Germany Article no. Artikelnummer/ Modelo Número / статья НОМЕР	NM-Germany Article no.	NM-Germany Article no.	NM-Germany Article no.	NM-Germany Article no.	NM-Germany Article no.	NM-Germany Article no.	NM-Germany Article no.	
	<b>LBSPG40617GF</b>	<b>LBPBG40617GF</b>	<b>KBSPG40617G</b>	<b>KBPG40617G</b>	<b>KRPG40617G</b>	<b>ORPG40617G</b>		

PEUGEOT



## GASOLINE

ENGINE TYPE Motortyp Type de Moteur Tipo de motor Тип двигателя	LINER KIT Liner Kit Kit de Chemise Camisas de los cilindros лайнер комплект	CYL. LINER Zylinderlaufbuchse Chemise Camisas de los cilindros втулка цилиндра	PISTON + RINGS Kolben + Ringe Piston + Segments Pistón Set Поршень и кольца			PISTON SET Kolben Set Set de Piston Pistón Set поршневой	RINGS SET Kolben Set Segments de Piston Anillos Set кольца	PIN Pin Axe Perno Пин
<b>XM 7</b> <b>XM 7 P</b> <b>XM 7 T</b> 4 Cyl 84.0 mm Bore Ø 1,796 cc	<b>K-99538960</b>	Length: 135.5	Length: 70.6			Top: 1.5	Ø: 23.0 Length: 70.0	
		Outside Ø: 92.95	Comp: 37.3			2nd: 2.0		
		Flange Ø: 99.5	Height: 1.1			3rd: 4.0		
		collar depth 90.0				1st oil: 4.0		
			<b>Reference no.:</b>	<b>Reference no.:</b>	<b>Reference no.:</b>	<b>Reference no.:</b>	<b>O-RING</b>	
			<b>K-88634110</b> <b>M-039WN10</b>	<b>K-99538600</b>		<b>A-R66060</b> <b>G-0831530000</b> <b>K-800006640000</b> <b>M-03932N0</b>	<b>ORPG40618G</b>	
NM-Germany Article no. Artikelnummer/ Modelo Número / статья НОМЕР	NM-Germany Article no.	NM-Germany Article no.	NM-Germany Article no.	NM-Germany Article no.	NM-Germany Article no.	NM-Germany Article no.	NM-Germany Article no.	
	<b>LBSPG40618GF</b>	<b>LBPBG40618GF</b>	<b>KBSPG40618G</b>	<b>KBPG40618G</b>	<b>KRPG40618G</b>	<b>KRPG40618G</b>		

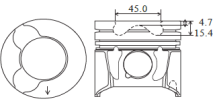

## GASOLINE

ENGINE TYPE Motortyp Type de Moteur Tipo de motor Тип двигателя	LINER KIT Liner Kit Kit de Chemise Camisas de los cilindros лайнер комплект	CYL. LINER Zylinderlaufbuchse Chemise Camisas de los cilindros втулка цилиндра	PISTON + RINGS Kolben + Ringe Piston + Segments Pistón Set Поршень и кольца			PISTON SET Kolben Set Set de Piston Pistón Set поршневой	RINGS SET Kolben Set Segments de Piston Anillos Set кольца	PIN Pin Axe Perno Пин
<b>DW10 ATED/</b> <b>ATED3</b> <b>DW10 BTED/TD/</b> <b>TED RHY/RHZ</b> 4 Cyl 85.0 mm Bore Ø 1,997 cc		Length: 155.0	Length: 80.7			Top: 3.5	Ø: 28.0 Length: 70.0	
		Outside Ø: 89.06	Comp: 46.7			double key-stone		
		Flange Ø: 91.0	Height: -6.0			2nd: 2.0		
		flange depth 4.5				3rd: 3.0		
			<b>Reference no.:</b>	<b>Reference no.:</b>	<b>Reference no.:</b>	<b>Reference no.:</b>	<b>O-RING</b>	
				<b>A-A350566</b> <b>K-99879601</b> <b>M-0399900</b> <b>N-8711470000</b>	<b>0628 N3</b>	<b>A-R60410</b> <b>G-0811470000</b> <b>K-800045940000</b> <b>M-03999N0</b>		
NM-Germany Article no. Artikelnummer/ Modelo Número / статья НОМЕР	NM-Germany Article no.	NM-Germany Article no.	NM-Germany Article no.	NM-Germany Article no.	NM-Germany Article no.	NM-Germany Article no.	NM-Germany Article no.	
	<b>LBSPG40619GSA</b>	<b>LBPBG40619GSA</b>	<b>KBSPG40619GA</b>	<b>KBPG40619GA</b>	<b>KRPG40619GA</b>	<b>KRPG40619GA</b>		

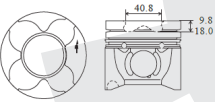

**GASOLINE**

ENGINE TYPE Motortyp Type de Moteur Tipo de motor Тип двигателя	LINER KIT Liner Kit Kit de Chemise Camisas de los cilindros лайнер комплект	CYL. LINER Zylinderlaufbuchse Chemise Camisas de los cilindros втулка цилиндра	PISTON + RINGS Kolben + Ringe Piston + Segments Pistón Set Поршень и кольца	PISTON SET Kolben Set Set de Piston Pistón Set поршневой	RINGS SET Kolben Set Segments de Piston Anillos Set кольца	PIN Pin Axe Perno Пин
<b>DW10 BTED4</b> 4 Cyl 85.0 mm Bore Ø 1,997 cc	<b>K-99700600</b> <b>A-R60410</b> <b>G-0811470000</b> <b>K-800045940000</b> <b>M-03999N0</b>	Length: 165.0 Outside Ø: 89.06 Flange Ø: 91.0 flange depth 4.5	Length: 80.7 Comp: 46.7 Height: -4.7 -15.4	alfin and with oil gallery skirt MOS2 treated fits tapered con. rod	Top: 3.5 double key-stone 2nd: 2.0 3rd: 2.0 1st oil: 3.0 2nd oil:	Ø: 28.0 Length: 70.0
Reference no.:		Reference no.:		Reference no.:		O-RING
						
NM-Germany Article no. Artikelnummer/ Modelo Número / статья НОМЕР	NM-Germany Article no.	NM-Germany Article no.	NM-Germany Article no.	NM-Germany Article no.	NM-Germany Article no.	NM-Germany Article no.
	<b>LBSPG40620GSB</b>	<b>LBPG40620GSB</b>	<b>KBSPG40620GB</b>	<b>KBPG40620GB</b>	<b>KRPG40620GB</b>	

**GASOLINE**

ENGINE TYPE Motortyp Type de Moteur Tipo de motor Тип двигателя	LINER KIT Liner Kit Kit de Chemise Camisas de los cilindros лайнер комплект	CYL. LINER Zylinderlaufbuchse Chemise Camisas de los cilindros втулка цилиндра	PISTON + RINGS Kolben + Ringe Piston + Segments Pistón Set Поршень и кольца	PISTON SET Kolben Set Set de Piston Pistón Set поршневой	RINGS SET Kolben Set Segments de Piston Anillos Set кольца	PIN Pin Axe Perno Пин
<b>DW12 TED4</b> 4 Cyl 85.0 mm Bore Ø 2,179 cc	<b>K-40406600</b> <b>A-R60410</b> <b>G-0811470000</b> <b>K-800045940000</b> <b>M-03999N0</b>	Length: 165.0 Outside Ø: 89.06 Flange Ø: 91.0 flange depth 4.5	Length: 77.7 Comp: 48.7 Height: -9.8 -18.0	alfin and with oil gallery skirt MOS2 treated	Top: 3.5 double key-stone 2nd: 2.0 3rd: 2.0 1st oil: 3.0 2nd oil:	Ø: 30.0 Length: 68.0
Reference no.:		Reference no.:		Reference no.:		O-RING
						
NM-Germany Article no. Artikelnummer/ Modelo Número / статья НОМЕР	NM-Germany Article no.	NM-Germany Article no.	NM-Germany Article no.	NM-Germany Article no.	NM-Germany Article no.	NM-Germany Article no.
	<b>LBSPG40621GSB</b>	<b>LBPG40621GSB</b>	<b>KBSPG40621GB</b>	<b>KBPG40621GB</b>	<b>KRPG40621GB</b>	

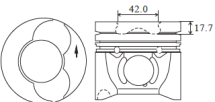
**GASOLINE**

ENGINE TYPE Motortyp Type de Moteur Tipo de motor Тип двигателя	LINER KIT Liner Kit Kit de Chemise Camisas de los cilindros лайнер комплект	CYL. LINER Zylinderlaufbuchse Chemise Camisas de los cilindros втулка цилиндра	PISTON + RINGS Kolben + Ringe Piston + Segments Pistón Set Поршень и кольца	PISTON SET Kolben Set Set de Piston Pistón Set поршневой	RINGS SET Kolben Set Segments de Piston Anillos Set кольца	PIN Pin Axe Perno Пин
<b>DW12 TED DW12 UTED</b> 4 Cyl 85.0 mm Bore Ø 2,179 cc		Length: 165.0 Outside Ø: 89.06 Flange Ø: 91.0 flange depth 4.5	Length: 77.7 Comp: 48.7 Height: -1.2 -17.7	alfin skirt MOS2 treated	Top: 3.5 double key-stone 2nd: 2.0 3rd: 2.0 1st oil: 3.0 2nd oil:	Ø: 30.0 Length: 68.0
Reference no.:		Reference no.:		Reference no.:		O-RING
						
NM-Germany Article no. Artikelnummer/ Modelo Número / статья НОМЕР	NM-Germany Article no.	NM-Germany Article no.	NM-Germany Article no.	NM-Germany Article no.	NM-Germany Article no.	NM-Germany Article no.
	<b>LBSPG40622GSA</b>	<b>LBPG40622GSA</b>	<b>KBSPG40622GA</b>	<b>KBPG40622GA</b>	<b>KRPG40622GA</b>	

**GASOLINE**

ENGINE TYPE Motortyp Type de Moteur Tipo de motor Тип двигателя	LINER KIT Liner Kit Kit de Chemise Camisas de los cilindros лайнер комплект	CYL. LINER Zylinderlaufbuchse Chemise Camisas de los cilindros втулка цилиндра	PISTON + RINGS Kolben + Ringe Piston + Segments Pistón Set Поршень и кольца			PISTON SET Kolben Set Set de Piston Pistón Set поршневой	RINGS SET Kolben Set Segments de Piston Anillos Set кольца	PIN Pin Axe Perno Пин				
<b>EW 10 J4</b> 4 Cyl 85.0 mm Bore Ø 1,997 cc		Length: 51.0 Comp: 29.0 Height: -0.7	skirt MOS2 treated	Top: 1.2 2nd: 1.5 3rd: 2.5 1st oil: 2nd oil:	Ø: 21.0 Length: 58.0							
								Reference no.:	Reference no.:	Reference no.:	Reference no.:	O-RING
									<b>K-40309600</b> <b>M-0401600</b>	<b>0628 K4</b>	<b>K-800059240000</b> <b>M-04016N0</b>	
NM-Germany Article no. Artikelnummer/ Modelo Número / статья НОМЕР	NM-Germany Article no.	NM-Germany Article no.	NM-Germany Article no.	NM-Germany Article no.	NM-Germany Article no.	NM-Germany Article no.	NM-Germany Article no.					
			<b>KBSPG40623G</b>	<b>KBPG40623G</b>	<b>KRPG40623G</b>							

PEUGEOT



**GASOLINE**

ENGINE TYPE Motortyp Type de Moteur Tipo de motor Тип двигателя	LINER KIT Liner Kit Kit de Chemise Camisas de los cilindros лайнер комплект	CYL. LINER Zylinderlaufbuchse Chemise Camisas de los cilindros втулка цилиндра	PISTON + RINGS Kolben + Ringe Piston + Segments Pistón Set Поршень и кольца			PISTON SET Kolben Set Set de Piston Pistón Set поршневой	RINGS SET Kolben Set Segments de Piston Anillos Set кольца	PIN Pin Axe Perno Пин				
<b>EW 10 A</b> 4 Cyl 85.0 mm Bore Ø 1,997 cc		Length: 50.9 Comp: 29.0 Height: 0.15 flange depth -3.8	skirt MOS2 treated fits tapered con. rod	Top: 1.2 2nd: 1.5 3rd: 2.5 1st oil: 2nd oil:	Ø: 21.0 Length: 56.0							
								Reference no.:	Reference no.:	Reference no.:	Reference no.:	O-RING
									<b>K-40273600</b>	<b>0628 R7</b> <b>0628 T8</b>	<b>K-800059240000</b> <b>M-04016N0</b>	
NM-Germany Article no. Artikelnummer/ Modelo Número / статья НОМЕР	NM-Germany Article no.	NM-Germany Article no.	NM-Germany Article no.	NM-Germany Article no.	NM-Germany Article no.	NM-Germany Article no.	NM-Germany Article no.					
			<b>KBSPG40624G</b>	<b>KBPG40624G</b>	<b>KRPG40624G</b>							

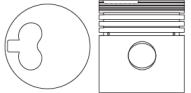

**GASOLINE**

ENGINE TYPE Motortyp Type de Moteur Tipo de motor Тип двигателя	LINER KIT Liner Kit Kit de Chemise Camisas de los cilindros лайнер комплект	CYL. LINER Zylinderlaufbuchse Chemise Camisas de los cilindros втулка цилиндра	PISTON + RINGS Kolben + Ringe Piston + Segments Pistón Set Поршень и кольца			PISTON SET Kolben Set Set de Piston Pistón Set поршневой	RINGS SET Kolben Set Segments de Piston Anillos Set кольца	PIN Pin Axe Perno Пин					
<b>ZM ZNJ</b> 6 Cyl 88.0 mm Bore Ø 2,664 cc	<b>M-0395590</b>	Length: 131.9 Outside Ø: 93.5 Flange Ø: 102.2 collar depth 99.13	Length: 63.3 Comp: 38.45 Height: 1.1		Top: 1.5 2nd: 2.0 3rd: 4.0 1st oil: 2nd oil:	Ø: 23.5 Length: 72.0							
									Reference no.:	Reference no.:	Reference no.:	Reference no.:	O-RING
									<b>M-039WN14</b>	<b>K-92875600</b> <b>M-0395500</b>		<b>0640 27</b> <b>0640 31</b> <b>A-R66110</b> <b>G-0831690000</b> <b>K-800003841000</b> <b>M-03953N0</b> <b>T-50023</b>	
NM-Germany Article no. Artikelnummer/ Modelo Número / статья НОМЕР	NM-Germany Article no.	NM-Germany Article no.	NM-Germany Article no.	NM-Germany Article no.	NM-Germany Article no.	NM-Germany Article no.	NM-Germany Article no.						
	<b>LBSPG60625GF</b>	<b>LBPG60625GF</b>	<b>KBSPG60625G</b>	<b>KBPG60625G</b>	<b>KRPG60625G</b>	<b>ORPG60625G</b>							

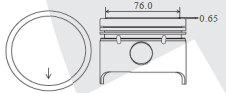

**GASOLINE**

ENGINE TYPE Motortyp Type de Moteur Tipo de motor Тип двигателя	LINER KIT Liner Kit Kit de Chemise Camisas de los cilindros лайнер комплект	CYL. LINER Zylinderlaufbuchse Chemise Camisas de los cilindros втулка цилиндра	PISTON + RINGS Kolben + Ringe Piston + Segments Pistón Set Поршень и кольца		PISTON SET Kolben Set Set de Piston Pistón Set поршневой	RINGS SET Kolben Set Segments de Piston Anillos Set кольца	PIN Pin Axe Perno Пин
<b>TMD 4.88</b> <b>XD P 4.88</b> <b>XD 4.88/XD 88</b> 4 Cyl 88.0 mm Bore Ø 1,948 cc 	<b>M-0395490</b> <b>K-92791960</b>	Length: 173.1 Outside Ø: 96.0 Flange Ø: 106.3 flange depth 7.0	Length: 95.35 Comp: 58.7 Height: -2.0			Top: 2.0 2nd: 2.0 3rd: 2.0 1st oil: 4.5 2nd oil:	Ø: 28.0 Length: 72.0
		Reference no.:	Reference no.:	Reference no.:	Reference no.:	O-RING	
		<b>M-039WN12</b> <b>K-88524110</b>	<b>M-0395400</b> <b>K-92791600</b>		<b>M-03954V0</b> <b>K-800009240000</b>		
NM-Germany Article no. Artikelnummer/ Modelo Número / статья НОМЕР	NM-Germany Article no.	NM-Germany Article no.	NM-Germany Article no.	NM-Germany Article no.	NM-Germany Article no.	NM-Germany Article no.	NM-Germany Article no.
	LBSPG40626GS	LBP40626GS	KBSPG40626G	KBPG40626G	KRPG40626G	ORPG40626G	

**GASOLINE**

ENGINE TYPE Motortyp Type de Moteur Tipo de motor Тип двигателя	LINER KIT Liner Kit Kit de Chemise Camisas de los cilindros лайнер комплект	CYL. LINER Zylinderlaufbuchse Chemise Camisas de los cilindros втулка цилиндра	PISTON + RINGS Kolben + Ringe Piston + Segments Pistón Set Поршень и кольца		PISTON SET Kolben Set Set de Piston Pistón Set поршневой	RINGS SET Kolben Set Segments de Piston Anillos Set кольца	PIN Pin Axe Perno Пин
<b>XN 1/XN 2 XN 1P/</b> <b>XN 1T</b> 4 Cyl 88.0 mm Bore Ø 1,971 cc 	<b>A-SA2494</b> <b>K-93908960</b>	Length: 135.5 Outside Ø: 92.95 Flange Ø: 101.9 collar depth 90.0	Length: 71.75 Comp: 38.25 Height: 0.65			Top: 1.5 2nd: 2.0 3rd: 4.0 1st oil: 2nd oil:	Ø: 23.0 Length: 74.0
		Reference no.:	Reference no.:	Reference no.:	Reference no.:	O-RING	
		<b>K-88589110</b> <b>M-039WN13</b>	<b>K-93908600</b>		<b>A-R66110</b> <b>G-0831690000</b> <b>K-800003841000</b> <b>M-03953N0</b> <b>T-50023</b>	<b>K-50006663</b>	
NM-Germany Article no. Artikelnummer/ Modelo Número / статья НОМЕР	NM-Germany Article no.	NM-Germany Article no.	NM-Germany Article no.	NM-Germany Article no.	NM-Germany Article no.	NM-Germany Article no.	NM-Germany Article no.
	LBSPG40627GF	LBP40627GF	KBSPG40627G	KBPG40627G	KRPG40627G	ORPG40627G	

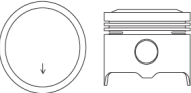
**GASOLINE**

ENGINE TYPE Motortyp Type de Moteur Tipo de motor Тип двигателя	LINER KIT Liner Kit Kit de Chemise Camisas de los cilindros лайнер комплект	CYL. LINER Zylinderlaufbuchse Chemise Camisas de los cilindros втулка цилиндра	PISTON + RINGS Kolben + Ringe Piston + Segments Pistón Set Поршень и кольца		PISTON SET Kolben Set Set de Piston Pistón Set поршневой	RINGS SET Kolben Set Segments de Piston Anillos Set кольца	PIN Pin Axe Perno Пин
<b>XN 1/XN 2 XN 1P/</b> <b>XN 1T</b> 4 Cyl 88.0 mm Bore Ø 1,971 cc 	<b>K-93316960</b> <b>M-0395390</b>	Length: 135.5 Outside Ø: 92.95 Flange Ø: 101.9 collar depth 90.0	Length: 73.4 Comp: 37.9 Height: 2.6			Top: 1.5 2nd: 2.0 3rd: 4.0 1st oil: 2nd oil:	Ø: 23.0 Length: 74.0
		Reference no.:	Reference no.:	Reference no.:	Reference no.:	O-RING	
		<b>K-88589110</b> <b>M-039WN13</b>	<b>K-93316600</b> <b>M-0395300</b>		<b>A-R66110</b> <b>G-0831690000</b> <b>K-800003841000</b> <b>M-03953N0</b> <b>T-50023</b>	<b>K-50006663</b>	
NM-Germany Article no. Artikelnummer/ Modelo Número / статья НОМЕР	NM-Germany Article no.	NM-Germany Article no.	NM-Germany Article no.	NM-Germany Article no.	NM-Germany Article no.	NM-Germany Article no.	NM-Germany Article no.
	LBSPG40628GF	LBP40628GF	KBSPG40628G	KBPG40628G	KRPG40628G	ORPG40628G	



## GASOLINE

ENGINE TYPE Motortyp Type de Moteur Tipo de motor Тип двигателя	LINER KIT Liner Kit Kit de Chemise Camisas de los cilindros лайнер комплект	CYL. LINER Zylinderlaufbuchse Chemise Camisas de los cilindros втулка цилиндра	PISTON + RINGS Kolben + Ringe Piston + Segments Pistón Set Поршень и кольца		PISTON SET Kolben Set Set de Piston Pistón Set поршневой	RINGS SET Kolben Set Segments de Piston Anillos Set кольца	PIN Pin Axe Perno Пин	
<b>504</b> 4 Cyl 88.0 mm Bore Ø 1,971 cc		Length: Outside Ø: Flange Ø: flange depth	Length:	71.9		Top:	1.5	Ø: 23.0 Length: 74.0
			Comp:	37.8		2nd:	2.0	
			Height:	0.5		3rd:	4.0	
			Reference no.:	Reference no.:	Reference no.:	Reference no.:	O-RING	
						<b>0640 27</b> <b>0640 31</b> <b>A-R66110</b> <b>G-0831690000</b> <b>K-800003841000</b> <b>M-03953N0</b> <b>T-50023</b>		
NM-Germany Article no. Artikelnummer/ Modelo Número / статья НОМЕР	NM-Germany Article no.	NM-Germany Article no.	NM-Germany Article no.	NM-Germany Article no.	NM-Germany Article no.	NM-Germany Article no.	NM-Germany Article no.	
			<b>KBSPG40629G</b>	<b>KBPG40629G</b>	<b>KRPG40629G</b>			

PEUGEOT



## GASOLINE

ENGINE TYPE Motortyp Type de Moteur Tipo de motor Тип двигателя	LINER KIT Liner Kit Kit de Chemise Camisas de los cilindros лайнер комплект	CYL. LINER Zylinderlaufbuchse Chemise Camisas de los cilindros втулка цилиндра	PISTON + RINGS Kolben + Ringe Piston + Segments Pistón Set Поршень и кольца		PISTON SET Kolben Set Set de Piston Pistón Set поршневой	RINGS SET Kolben Set Segments de Piston Anillos Set кольца	PIN Pin Axe Perno Пин	
<b>504</b> 4 Cyl 88.0 mm Bore Ø 1,971 cc		Length: Outside Ø: Flange Ø: flange depth	Length:	71.9		Top:	1.5	Ø: 23.0 Length: 74.0
			Comp:	38.1		2nd:	2.0	
			Height:	0.8		3rd:	4.0	
			Reference no.:	Reference no.:	Reference no.:	Reference no.:	O-RING	
						<b>0640 27</b> <b>0640 31</b> <b>A-R66110</b> <b>G-0831690000</b> <b>K-800003841000</b> <b>M-03953N0</b> <b>T-50023</b>		
NM-Germany Article no. Artikelnummer/ Modelo Número / статья НОМЕР	NM-Germany Article no.	NM-Germany Article no.	NM-Germany Article no.	NM-Germany Article no.	NM-Germany Article no.	NM-Germany Article no.	NM-Germany Article no.	
			<b>KBSPG40630G</b>	<b>KBPG40630G</b>	<b>KRPG40630G</b>			

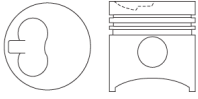

## DIESEL

ENGINE TYPE Motortyp Type de Moteur Tipo de motor Тип двигателя	LINER KIT Liner Kit Kit de Chemise Camisas de los cilindros лайнер комплект	CYL. LINER Zylinderlaufbuchse Chemise Camisas de los cilindros втулка цилиндра	PISTON + RINGS Kolben + Ringe Piston + Segments Pistón Set Поршень и кольца		PISTON SET Kolben Set Set de Piston Pistón Set поршневой	RINGS SET Kolben Set Segments de Piston Anillos Set кольца	PIN Pin Axe Perno Пин		
<b>DJ5 T</b> <b>DK5 ATE</b> 4 Cyl 92.0 mm Bore Ø 2,446 cc		Length: Outside Ø: Flange Ø: flange depth	Length:	STD	O/S	alfin and with oil gallery head anodized skirt MOS2 treated fits tapered con. rod	Top:	3.0	Ø: 34.0 Length: 68.0
			Comp:	82.0	81.6		double key-stone		
			Height:	49.84	49.47		1.75		
			Reference no.:	Reference no.:	Reference no.:	Reference no.:	O-RING		
				<b>A-A354071</b> <b>K-91313700</b> <b>M-0390600</b>	<b>0628 91</b>	<b>0640 G9</b> <b>0640 J8</b> <b>A-R67430</b> <b>G-0832630000</b> <b>K-800059940000</b> <b>M-03906N0</b>			
NM-Germany Article no. Artikelnummer/ Modelo Número / статья НОМЕР	NM-Germany Article no.	NM-Germany Article no.	NM-Germany Article no.	NM-Germany Article no.	NM-Germany Article no.	NM-Germany Article no.	NM-Germany Article no.		
			<b>KBSPG40631DB</b>	<b>KBPG40631DB</b>	<b>KRPG40631DB</b>				



**GASOLINE**

ENGINE TYPE Motortyp Type de Moteur Tipo de motor Тип двигателя	LINER KIT Liner Kit Kit de Chemise Camisas de los cilindros лайнер комплект	CYL. LINER Zylinderlaufbuchse Chemise Camisas de los cilindros втулка цилиндра	PISTON + RINGS Kolben + Ringe Piston + Segments Pistón Set Поршень и кольца			PISTON SET Kolben Set Set de Piston Pistón Set поршневой	RINGS SET Kolben Set Segments de Piston Anillos Set кольца	PIN Pin Axe Perno Пин
<b>CRD 93</b> <b>CRD 93 L U25</b> 4 Cyl 93.01 mm Bore Ø 2,499 cc 	<b>K-93844970</b> <b>M-0318290</b>	Length: 163.0 Outside Ø: 97.5 Flange Ø: 99.0 flange depth 5.0	Length: 95.0 Comp: 52.75 Height: -7.4			Top: 2.5 2nd: 2.0 3rd: 4.0 1st oil: 2nd oil:	Ø: 30.0 Length: 78.0	
		Reference no.:	Reference no.:	Reference no.:	Reference no.:	O-RING		
		<b>K-89073190</b> <b>M-031WV16</b>	<b>A-350704</b> <b>K-93844700</b> <b>M-0318200</b> <b>N-8715270000</b>		<b>A-R60970</b> <b>G-0815270000</b> <b>K-800004041000</b> <b>M-03182N0</b>			
NM-Germany Article no. Artikelnummer/ Modelo Número / статья НОМЕР	NM-Germany Article no.	NM-Germany Article no.	NM-Germany Article no.	NM-Germany Article no.	NM-Germany Article no.	NM-Germany Article no.	NM-Germany Article no.	
	LBSPG40632GS	LBPG40632GS	KBSPG40632G	KBPG40632G	KRPG40632G			

**GASOLINE**

ENGINE TYPE Motortyp Type de Moteur Tipo de motor Тип двигателя	LINER KIT Liner Kit Kit de Chemise Camisas de los cilindros лайнер комплект	CYL. LINER Zylinderlaufbuchse Chemise Camisas de los cilindros втулка цилиндра	PISTON + RINGS Kolben + Ringe Piston + Segments Pistón Set Поршень и кольца			PISTON SET Kolben Set Set de Piston Pistón Set поршневой	RINGS SET Kolben Set Segments de Piston Anillos Set кольца	PIN Pin Axe Perno Пин
<b>XD 3P</b> 4 Cyl 94.0 mm Bore Ø 2,498 cc 	(A) <b>K-93625960</b> <b>M-0395192</b>	Length: 165.8 Outside Ø: 97.0 Flange Ø: 99.5 flange depth 3.9	Length: 96.42 Comp: 53.92 Height: -1.8		alfin	Top: 2.0 2nd: 2.0 3rd: 4.0 1st oil: 2nd oil:	Ø: 30.0 Length: 78.8	
		Reference no.:	Reference no.:	Reference no.:	Reference no.:	O-RING		
		<b>K-89412190</b> <b>M-039WV30</b>	<b>A-350708</b> <b>K-93625600</b> <b>M-0395100</b> <b>N-8731870010</b>	0623 61 0623 62 0623 70 0623 71 0623 73 0623 74 0626 04 0626 05 0627 05 0627 06 7306 23	<b>0640 33</b> <b>0640 42</b> <b>A-R66140</b> <b>G-0831870010</b> <b>K-800004140000</b> <b>M-03948N0</b>			
NM-Germany Article no. Artikelnummer/ Modelo Número / статья НОМЕР	NM-Germany Article no.	NM-Germany Article no.	NM-Germany Article no.	NM-Germany Article no.	NM-Germany Article no.	NM-Germany Article no.	NM-Germany Article no.	
	LBSPG40633GS LBSPG40633GSA	LBPG40633GSA	KBSPG40633G KBSPG40633GA	KBPG40633G KBPG40633GA	KRPG40633GA			

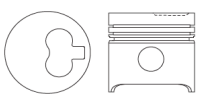
**GASOLINE**

ENGINE TYPE Motortyp Type de Moteur Tipo de motor Тип двигателя	LINER KIT Liner Kit Kit de Chemise Camisas de los cilindros лайнер комплект	CYL. LINER Zylinderlaufbuchse Chemise Camisas de los cilindros втулка цилиндра	PISTON + RINGS Kolben + Ringe Piston + Segments Pistón Set Поршень и кольца			PISTON SET Kolben Set Set de Piston Pistón Set поршневой	RINGS SET Kolben Set Segments de Piston Anillos Set кольца	PIN Pin Axe Perno Пин
<b>XD 2 XD 2P XD</b> <b>94</b> 4 Cyl 94.0 mm Bore Ø 2,304 cc 	<b>K-93520960</b> <b>M-0395090</b>	Length: 170.6 Outside Ø: 97.0 Flange Ø: 99.5 flange depth 3.9	Length: 99.92 Comp: 57.42 Height: -1.8			Top: 2.0 2nd: 2.0 3rd: 4.0 1st oil: 2nd oil:	Ø: 30.0 Length: 78.8	
		Reference no.:	Reference no.:	Reference no.:	Reference no.:	O-RING		
		<b>K-89033190</b> <b>M-039WV16</b>	<b>A-350707</b> <b>K-93520600</b> <b>M-0395000</b> <b>N-8731870000</b>		<b>A-R66140</b> <b>G-0831870010</b> <b>K-800004140000</b> <b>M-03948N0</b>			
NM-Germany Article no. Artikelnummer/ Modelo Número / статья НОМЕР	NM-Germany Article no.	NM-Germany Article no.	NM-Germany Article no.	NM-Germany Article no.	NM-Germany Article no.	NM-Germany Article no.	NM-Germany Article no.	
	LBSPG40634GS	LBPG40634GS	KBSPG40634G	KBPG40634G	KRPG40634G			

**GASOLINE**

ENGINE TYPE Motortyp Type de Moteur Tipo de motor Тип двигателя	LINER KIT Liner Kit Kit de Chemise Camisas de los cilindros лайнер комплект	CYL. LINER Zylinderlaufbuchse Chemise Camisas de los cilindros втулка цилиндра	PISTON + RINGS Kolben + Ringe Piston + Segments Pistón Set Поршень и кольца			PISTON SET Kolben Set Set de Piston Pistón Set поршневой	RINGS SET Kolben Set Segments de Piston Anillos Set кольца	PIN Pin Axe Perno Пин				
<b>XD 2S TURBO</b> 4 Cyl 94.0 mm Bore Ø 2,304 cc	<b>M-0395290</b>	Length: 170.6 Outside Ø: 97.0 Flange Ø: 99.5 flange depth 3.9	Length: 99.87 Comp: 57.37 Height: -1.95		alfin	Top: 3.0 double key-stone 2nd: 2.0 3rd: 4.0 1st oil: 2nd oil:	Ø: 30.0 Length: 78.0					
								Reference no.:	Reference no.:	Reference no.:	Reference no.:	O-RING
								<b>K-89033190</b> <b>M-039VV16</b>	<b>K-93703600</b> <b>M-0395200</b>	<b>0623 33</b> <b>0626 37</b> <b>0626 38</b>	<b>0640 39</b> <b>0640 52</b> <b>0640 87</b> <b>A-R66000</b> <b>G-0832020010</b> <b>M-03947N0</b> <b>M-03952N0</b>	
NM-Germany Article no. Artikelnummer/ Modelo Número / статья НОМЕР	NM-Germany Article no.	NM-Germany Article no.	NM-Germany Article no.	NM-Germany Article no.	NM-Germany Article no.	NM-Germany Article no.	NM-Germany Article no.					
	<b>LBSPG40635GSA</b>	<b>LBPG40635GSA</b>	<b>KBSPG40635GA</b>	<b>KBPG40635GA</b>	<b>KRPG40635GA</b>							

PEUGEOT



**GASOLINE**

ENGINE TYPE Motortyp Type de Moteur Tipo de motor Тип двигателя	LINER KIT Liner Kit Kit de Chemise Camisas de los cilindros лайнер комплект	CYL. LINER Zylinderlaufbuchse Chemise Camisas de los cilindros втулка цилиндра	PISTON + RINGS Kolben + Ringe Piston + Segments Pistón Set Поршень и кольца			PISTON SET Kolben Set Set de Piston Pistón Set поршневой	RINGS SET Kolben Set Segments de Piston Anillos Set кольца	PIN Pin Axe Perno Пин				
<b>XD 3T TURBO</b> <b>XD 3TE TURBO</b> 4 Cyl 94.0 mm Bore Ø 2,498 cc	<b>K-93608960</b> <b>M-0394792</b>	Length: 165.8 Outside Ø: 97.0 Flange Ø: 99.5 flange depth 3.9	Length: 96.37 Comp: 53.87 Height: -2.27		alfin and with oil gallery skirt MOS2 treated	Top: 3.0 double key-stone 2nd: 2.0 3rd: 4.0 1st oil: 2nd oil:	Ø: 32.0 Length: 78.8					
								Reference no.:	Reference no.:	Reference no.:	Reference no.:	O-RING
								<b>K-89412190</b> <b>M-039VV30</b>	<b>K-93608600</b> <b>M-0394700</b>	<b>0626 15/16/19</b> <b>0626 20/21/22</b> <b>0626 23/24/25</b>	<b>0640 39</b> <b>0640 52</b> <b>0640 87</b> <b>A-R66000</b> <b>G-0832020010</b> <b>M-03947N0</b> <b>M-03952N0</b>	
NM-Germany Article no. Artikelnummer/ Modelo Número / статья НОМЕР	NM-Germany Article no.	NM-Germany Article no.	NM-Germany Article no.	NM-Germany Article no.	NM-Germany Article no.	NM-Germany Article no.	NM-Germany Article no.					
	<b>LBSPG40636GSB</b>	<b>LBPG40636GSB</b>	<b>KBSPG40636GB</b>	<b>KBPG40636GB</b>	<b>KRPG40636GB</b>							

**GASOLINE**

ENGINE TYPE Motortyp Type de Moteur Tipo de motor Тип двигателя	LINER KIT Liner Kit Kit de Chemise Camisas de los cilindros лайнер комплект	CYL. LINER Zylinderlaufbuchse Chemise Camisas de los cilindros втулка цилиндра	PISTON + RINGS Kolben + Ringe Piston + Segments Pistón Set Поршень и кольца			PISTON SET Kolben Set Set de Piston Pistón Set поршневой	RINGS SET Kolben Set Segments de Piston Anillos Set кольца	PIN Pin Axe Perno Пин				
<b>8140.23 TURBO</b> 4 Cyl 94.4 mm Bore Ø 2,798 cc	<b>K-94701960</b> <b>M-0098990</b>	Length: 167.0 Outside Ø: 97.5 Flange Ø: 100.9 flange depth 5.0	Length: 87.6 Comp: 58.8 Height: -15.1		alfin and with oil gallery skirt MOS2 treated fits tapered con. rod	Top: 2.5 double key-stone 2nd: 2.0 3rd: 2.5 1st oil: 2nd oil:	Ø: 32.0 Length: 72.0					
								Reference no.:	Reference no.:	Reference no.:	Reference no.:	O-RING
								<b>G-1402839000</b> <b>K-89502190</b> <b>M-007VV56</b>	<b>A-A350582</b> <b>K-94701600</b> <b>M-0098900</b>		<b>A-R60070</b> <b>G-0812220000</b> <b>K-800038241000</b> <b>M-00990N0</b>	
NM-Germany Article no. Artikelnummer/ Modelo Número / статья НОМЕР	NM-Germany Article no.	NM-Germany Article no.	NM-Germany Article no.	NM-Germany Article no.	NM-Germany Article no.	NM-Germany Article no.	NM-Germany Article no.					
	<b>LBSPG40637GSB</b>	<b>LBPG40637GSB</b>	<b>KBSPG40637GB</b>	<b>KBPG40637GB</b>	<b>KRPG40637GB</b>							

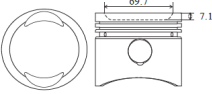
## GASOLINE

ENGINE TYPE Motortyp Type de Moteur Tipo de motor Тип двигателя	LINER KIT Liner Kit Kit de Chemise Camisas de los cilindros лайнер комплект	CYL. LINER Zylinderlaufbuchse Chemise Camisas de los cilindros втулка цилиндра	PISTON + RINGS Kolben + Ringe Piston + Segments Pistón Set Поршень и кольца		PISTON SET Kolben Set Set de Piston Pistón Set поршневой	RINGS SET Kolben Set Segments de Piston Anillos Set кольца	PIN Pin Axe Perno Пин	
<b>831</b>  <b>4 Cyl</b> <b>86.5 mm Bore Ø</b> <b>1,984 cc</b>  			Length:	77.7		Top:	2.0	Ø: 24.0 Length: 73.0
			Outside Ø:	40.7		2nd:	2.5	
			Flange Ø:	-7.1		3rd:	5.0	
			flange depth			1st oil:		
			Reference no.:	Reference no.:	Reference no.:	Reference no.:	O-RING	
				<b>K-92870600</b> <b>M-0346900</b>		<b>G-0839970010</b> <b>K-800001440000</b> <b>M-03469N0</b>		
NM-Germany Article no. Artikelnummer/ Modelo Número / статья НОМЕР	NM-Germany Article no.	NM-Germany Article no.	NM-Germany Article no.	NM-Germany Article no.	NM-Germany Article no.	NM-Germany Article no.	NM-Germany Article no.	
			<b>KBSPS40638G</b>	<b>KBPS40638G</b>	<b>KRPS40638G</b>			

**GASOLINE**

ENGINE TYPE Motortyp Type de Moteur Tipo de motor Тип двигателя	LINER KIT Liner Kit Kit de Chemise Camisas de los cilindros лайнер комплект	CYL. LINER Zylinderlaufbuchse Chemise Camisas de los cilindros втулка цилиндра	PISTON + RINGS Kolben + Ringe Piston + Segments Pistón Set Поршень и кольца			PISTON SET Kolben Set Set de Piston Pistón Set поршневой	RINGS SET Kolben Set Segments de Piston Anillos Set кольца	PIN Pin Axe Perno Пин	
<b>800/800.01/800.02</b> <b>800 05/800 710</b> <b>800 705/A7/</b> <b>B1B 707</b> 4 Cyl 58.0 mm Bore Ø 845 cc	<b>A-SA2554</b> <b>K-92073970</b> <b>M-0212290</b> <b>N-8933330000</b>	Length:	126.1	Length:	64.0	Top:	1.75	Ø: 16.0  Length: 49.0	
		Outside Ø:	62.5	Comp:	30.0	2nd:	2.0		
		Flange Ø:	69.5	Height:	0	3rd:	3.5		
collar depth		112.8				1st oil:		2nd oil:	
<b>Reference no.:</b>		<b>Reference no.:</b>		<b>Reference no.:</b>		<b>Reference no.:</b>		<b>O-RING</b>	
		<b>K-88574110</b> <b>M-021WN05</b>		<b>K-92073700</b> <b>M-0212200</b>		<b>A-R66210</b> <b>G-0833330000</b> <b>K-800022641000</b> <b>M-02122N0</b>		<b>ORRN40639G</b>	
NM-Germany Article no. Artikelnummer/ Modelo Número / статья НОМЕР	NM-Germany Article no.	NM-Germany Article no.	NM-Germany Article no.	NM-Germany Article no.	NM-Germany Article no.	NM-Germany Article no.	NM-Germany Article no.		
	LBSRN40639GF	LBRN40639GF	KBSRN40639G	KBRN40639G	KRRN40639G				

**GASOLINE**

ENGINE TYPE Motortyp Type de Moteur Tipo de motor Тип двигателя	LINER KIT Liner Kit Kit de Chemise Camisas de los cilindros лайнер комплект	CYL. LINER Zylinderlaufbuchse Chemise Camisas de los cilindros втулка цилиндра	PISTON + RINGS Kolben + Ringe Piston + Segments Pistón Set Поршень и кольца			PISTON SET Kolben Set Set de Piston Pistón Set поршневой	RINGS SET Kolben Set Segments de Piston Anillos Set кольца	PIN Pin Axe Perno Пин	
<b>D7F 700/701/702/703</b> <b>D7F 704/710/720/722</b> <b>D7F 726/730/746/766</b> 4 Cyl 69.0 mm Bore Ø 1,149 cc		Length:		STD	O/S	Top:	1.5	Ø: 17.5  Length: 54.0	
		Outside Ø:		Length:	50.5	50.5	2nd:		1.5
		Flange Ø:		Comp:	27.1	26.8	3rd:		2.5
flange depth			Height:	0	0	1st oil:		2nd oil:	
<b>Reference no.:</b>		<b>Reference no.:</b>		<b>Reference no.:</b>		<b>Reference no.:</b>		<b>O-RING</b>	
				<b>A-24145</b> <b>K-99646600</b> <b>M-0220400</b> <b>N-8710410000</b>		<b>77 01 474 305</b>		<b>77 01 472 045</b> <b>A-R60510</b> <b>G-0810410000</b> <b>K-800037540000</b> <b>M-02204N0</b> <b>M-A18700</b>	
NM-Germany Article no. Artikelnummer/ Modelo Número / статья НОМЕР	NM-Germany Article no.	NM-Germany Article no.	NM-Germany Article no.	NM-Germany Article no.	NM-Germany Article no.	NM-Germany Article no.	NM-Germany Article no.		
			KBSRN40640G	KBRN40640G	KRRN40640G				

RENAULT

**GASOLINE**

ENGINE TYPE Motortyp Type de Moteur Tipo de motor Тип двигателя	LINER KIT Liner Kit Kit de Chemise Camisas de los cilindros лайнер комплект	CYL. LINER Zylinderlaufbuchse Chemise Camisas de los cilindros втулка цилиндра	PISTON + RINGS Kolben + Ringe Piston + Segments Pistón Set Поршень и кольца			PISTON SET Kolben Set Set de Piston Pistón Set поршневой	RINGS SET Kolben Set Segments de Piston Anillos Set кольца	PIN Pin Axe Perno Пин	
<b>D4D 712</b> 4 Cyl 69.0 mm Bore Ø 999 cc		Length:		Length:	50.9	Top:	1.2	Ø: 17.5  Length: 54.0	
		Outside Ø:		Comp:	31.8	2nd:	1.5		
		Flange Ø:		Height:	+1.1	3rd:	2.5		
flange depth			-2.5			1st oil:		2nd oil:	
<b>Reference no.:</b>		<b>Reference no.:</b>		<b>Reference no.:</b>		<b>Reference no.:</b>		<b>O-RING</b>	
						<b>K-800056740000</b>			
NM-Germany Article no. Artikelnummer/ Modelo Número / статья НОМЕР	NM-Germany Article no.	NM-Germany Article no.	NM-Germany Article no.	NM-Germany Article no.	NM-Germany Article no.	NM-Germany Article no.	NM-Germany Article no.		
			KBSRN40641G	KBRN40641G	KRRN40641G				

**GASOLINE**

ENGINE TYPE Motortyp Type de Moteur Tipo de motor Тип двигателя	LINER KIT Liner Kit Kit de Chemise Camisas de los cilindros лайнер комплект	CYL. LINER Zylinderlaufbuchse Chemise Camisas de los cilindros втулка цилиндра	PISTON + RINGS Kolben + Ringe Piston + Segments Pistón Set Поршень и кольца	PISTON SET Kolben Set Set de Piston Pistón Set поршневой	RINGS SET Kolben Set Segments de Piston Anillos Set кольца	PIN Pin Axe Perno Пин	
<b>D4F 702/704/706/708</b> <b>D4F 714/716/722/728</b> <b>D4F 730/740/764/790</b> 4 Cyl 69.0 mm Bore Ø 1,149 cc		Length:	Length:	44.7	Top:	1.2	Ø: 17.5 Length: 54.0
		Outside Ø:	Comp:	26.7	2nd:	1.5	
		Flange Ø:	Height:	-1.0	3rd:	2.5	
		flange depth			1st oil:	2.5	
			Reference no.:	Reference no.:	Reference no.:	Reference no.:	O-RING
				<b>K-40219600</b>		<b>K-800056740000</b>	
NM-Germany Article no. Artikelnummer/ Modelo Número / статья НОМЕР	NM-Germany Article no.	NM-Germany Article no.	NM-Germany Article no.	NM-Germany Article no.	NM-Germany Article no.	NM-Germany Article no.	NM-Germany Article no.
			<b>KBSRN40642G</b>	<b>KBRN40642G</b>	<b>KRRN40642G</b>		



**GASOLINE**

ENGINE TYPE Motortyp Type de Moteur Tipo de motor Тип двигателя	LINER KIT Liner Kit Kit de Chemise Camisas de los cilindros лайнер комплект	CYL. LINER Zylinderlaufbuchse Chemise Camisas de los cilindros втулка цилиндра	PISTON + RINGS Kolben + Ringe Piston + Segments Pistón Set Поршень и кольца	PISTON SET Kolben Set Set de Piston Pistón Set поршневой	RINGS SET Kolben Set Segments de Piston Anillos Set кольца	PIN Pin Axe Perno Пин	
<b>D7D 740</b> 4 Cyl 69.0 mm Bore Ø 999 cc		Length:	Length:	55.5	Top:	1.5	Ø: 17.5 Length: 54.0
		Outside Ø:	Comp:	32.1	2nd:	1.5	
		Flange Ø:	Height:	+2.3	3rd:	2.5	
		flange depth		-1.5	1st oil:	2.5	
			Reference no.:	Reference no.:	Reference no.:	Reference no.:	O-RING
					77 00 112 366	77 01 472 045 A-R60510 G-0810410000 K-800037540000 M-02204N0 M-A18700	
NM-Germany Article no. Artikelnummer/ Modelo Número / статья НОМЕР	NM-Germany Article no.	NM-Germany Article no.	NM-Germany Article no.	NM-Germany Article no.	NM-Germany Article no.	NM-Germany Article no.	NM-Germany Article no.
			<b>KBSRN40643G</b>	<b>KBRN40643G</b>	<b>KRRN40643G</b>		



**GASOLINE**

ENGINE TYPE Motortyp Type de Moteur Tipo de motor Тип двигателя	LINER KIT Liner Kit Kit de Chemise Camisas de los cilindros лайнер комплект	CYL. LINER Zylinderlaufbuchse Chemise Camisas de los cilindros втулка цилиндра	PISTON + RINGS Kolben + Ringe Piston + Segments Pistón Set Поршень и кольца	PISTON SET Kolben Set Set de Piston Pistón Set поршневой	RINGS SET Kolben Set Segments de Piston Anillos Set кольца	PIN Pin Axe Perno Пин	
<b>688.01</b> <b>C 1 E</b> 4 Cyl 70.0 mm Bore Ø 1,108 cc	<b>77 01 452 156</b> <b>77 01 459 370</b> <b>77 01 459 375</b> <b>77 01 462 152</b> <b>77 01 465 307</b> <b>K-93695970</b> <b>M-0217580</b>	Length:	Length:	68.0	Top:	1.75	Ø: 18.0 Length: 62.0
		Outside Ø:	Comp:	40.0	2nd:	2.0	
		Flange Ø:	Height:	0	3rd:	3.5	
		collar depth		94.85	1st oil:	3.5	
			Reference no.:	Reference no.:	Reference no.:	Reference no.:	O-RING
			<b>K-88384110</b> <b>M-021WN08</b>	<b>K-93695700</b> <b>M-0217510</b>		<b>A-R66160</b> <b>G-0833460000</b> <b>K-800004240000</b> <b>M-02175V0</b>	<b>K-50006646</b>
NM-Germany Article no. Artikelnummer/ Modelo Número / статья НОМЕР	NM-Germany Article no.	NM-Germany Article no.	NM-Germany Article no.	NM-Germany Article no.	NM-Germany Article no.	NM-Germany Article no.	NM-Germany Article no.
	<b>LBSRN40644GF</b>	<b>LBRN40644GF</b>	<b>KBSRN40644G</b>	<b>KBRN40644G</b>	<b>KRRN40644G</b>	<b>ORRN40644G</b>	

## GASOLINE



ENGINE TYPE Motortyp Type de Moteur Tipo de motor Тип двигателя	LINER KIT Liner Kit Kit de Chemise Camisas de los cilindros лайнер комплект	CYL. LINER Zylinderlaufbuchse Chemise Camisas de los cilindros втулка цилиндра	PISTON + RINGS Kolben + Ringe Piston + Segments Pistón Set Поршень и кольца	PISTON SET Kolben Set Set de Piston Pistón Set поршневой	RINGS SET Kolben Set Segments de Piston Anillos Set кольца	PIN Pin Axe Perno Пин
<b>688</b> <b>C 1 E</b> 4 Cyl 70.0 mm Bore Ø 1,108 cc 		Length: 135.0 Outside Ø: 75.5 Flange Ø: 85.8 collar depth: 94.85	Length: 68.5 Comp: 40.0 Height: 0		Top: 2.0 2nd: 2.0 3rd: 3.5 1st oil: 2nd oil:	Ø: 18.0 Length: 61.9
		Reference no.:	Reference no.:	Reference no.:	Reference no.:	O-RING
		<b>K-88384110</b> <b>M-021WN08</b>			<b>A-R66150</b> <b>G-0833220000</b>	<b>K-50006646</b>
NM-Germany Article no. Artikelnummer/ Modelo Número / статья НОМЕР	NM-Germany Article no.	NM-Germany Article no.	NM-Germany Article no.	NM-Germany Article no.	NM-Germany Article no.	NM-Germany Article no.
	<b>LBSRN40645GF</b>	<b>LBRN40645GF</b>	<b>KBSRN40645G</b>	<b>KBRN40645G</b>	<b>KRRN40645G</b>	<b>ORRN40645G</b>

## GASOLINE



ENGINE TYPE Motortyp Type de Moteur Tipo de motor Тип двигателя	LINER KIT Liner Kit Kit de Chemise Camisas de los cilindros лайнер комплект	CYL. LINER Zylinderlaufbuchse Chemise Camisas de los cilindros втулка цилиндра	PISTON + RINGS Kolben + Ringe Piston + Segments Pistón Set Поршень и кольца	PISTON SET Kolben Set Set de Piston Pistón Set поршневой	RINGS SET Kolben Set Segments de Piston Anillos Set кольца	PIN Pin Axe Perno Пин
<b>810.03</b> <b>810.25</b> 4 Cyl 73.0 mm Bore Ø 1,289 cc 	<b>A-SA2551</b>	Length: 134.0 Outside Ø: 78.45 Flange Ø: 87.75 collar depth: 94.85	Length: 62.4 Comp: 37.5 Height: 0		Top: 1.75 2nd: 2.0 3rd: 4.0 1st oil: 2nd oil:	Ø: 20.0 Length: 62.0
		Reference no.:	Reference no.:	Reference no.:	Reference no.:	O-RING
		<b>K-88544110</b> <b>M-021WN09</b>			<b>A-R66220</b> <b>G-0833340010</b> <b>K-800004341000</b> <b>M-02134N0</b>	<b>K-50006644</b>
NM-Germany Article no. Artikelnummer/ Modelo Número / статья НОМЕР	NM-Germany Article no.	NM-Germany Article no.	NM-Germany Article no.	NM-Germany Article no.	NM-Germany Article no.	NM-Germany Article no.
	<b>LBSRN40646GF</b>	<b>LBRN40646GF</b>	<b>KBSRN40646G</b>	<b>KBRN40646G</b>	<b>KRRN40646G</b>	<b>ORRN40646G</b>

RENAULT



## GASOLINE

ENGINE TYPE Motortyp Type de Moteur Tipo de motor Тип двигателя	LINER KIT Liner Kit Kit de Chemise Camisas de los cilindros лайнер комплект	CYL. LINER Zylinderlaufbuchse Chemise Camisas de los cilindros втулка цилиндра	PISTON + RINGS Kolben + Ringe Piston + Segments Pistón Set Поршень и кольца	PISTON SET Kolben Set Set de Piston Pistón Set поршневой	RINGS SET Kolben Set Segments de Piston Anillos Set кольца	PIN Pin Axe Perno Пин
<b>C3G 700/702</b> <b>C3G 710/712</b> <b>C3G 720/750</b> 4 Cyl 74.0 mm Bore Ø 1,239 cc 	<b>A-SA2416</b> <b>K-94529960</b> <b>M-0210490</b> <b>N-8933730000</b>	Length: 135.0 Outside Ø: 78.6 Flange Ø: 88.2 collar depth: 94.9	Length: 61.0 Comp: 40.05 Height: +0		Top: 1.5 2nd: 1.75 3rd: 3.0 1st oil: 2nd oil:	Ø: 18.0 Length: 62.0
		Reference no.:	Reference no.:	Reference no.:	Reference no.:	O-RING
		<b>K-89458110</b> <b>M-021WN31</b>	<b>K-94529600</b> <b>M-0210400</b>	<b>77 01 467 246</b>	<b>77 01 467 684</b> <b>A-R60460</b> <b>G-0833730000</b> <b>M-02104N0</b>	
NM-Germany Article no. Artikelnummer/ Modelo Número / статья НОМЕР	NM-Germany Article no.	NM-Germany Article no.	NM-Germany Article no.	NM-Germany Article no.	NM-Germany Article no.	NM-Germany Article no.
	<b>LBSRN40647GF</b>	<b>LBRN40647GF</b>	<b>KBSRN40647G</b>	<b>KBRN40647G</b>	<b>KRRN40647G</b>	<b>ORRN40647G</b>

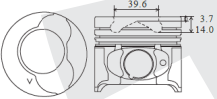

**GASOLINE**

ENGINE TYPE Motortyp Type de Moteur Tipo de motor Тип двигателя	LINER KIT Liner Kit Kit de Chemise Camisas de los cilindros лайнер комплект	CYL. LINER Zylinderlaufbuchse Chemise Camisas de los cilindros втулка цилиндра	PISTON + RINGS Kolben + Ringe Piston + Segments Pistón Set Поршень и кольца			PISTON SET Kolben Set Set de Piston Pistón Set поршневой	RINGS SET Kolben Set Segments de Piston Anillos Set кольца	PIN Pin Axe Perno Пин
<b>E6J E7J</b> 4 Cyl 75.8 mm Bore Ø 1,390 cc 	<b>77 01 465 037</b> <b>A-SA2529</b> <b>K-94532960</b> <b>M-0210390</b> <b>N-8933640010</b>	Length: 130.0	Length: 52.6			Top: 1.5	Ø: 19.0 Length: 64.0	
		Outside Ø: 80.6	Comp: 31.6			2nd: 1.75		
		Flange Ø: 90.2	Height: 0			3rd: 3.0		
		collar depth 91.5				1st oil: 3.0		
			<b>Reference no.:</b>	<b>Reference no.:</b>	<b>Reference no.:</b>	<b>Reference no.:</b>	<b>O-RING</b>	
			<b>A-SJ4328</b> <b>G-1563839000</b> <b>K-89448110</b> <b>M-021WN30</b>	<b>K-94532600</b> <b>M-0210300</b>	<b>77 01 471 158</b>	<b>A-R66200</b> <b>G-0833640000</b> <b>K-800022940000</b> <b>M-02101N0</b>		
NM-Germany Article no. Artikelnummer/ Modelo Número / статья НОМЕР	NM-Germany Article no.	NM-Germany Article no.	NM-Germany Article no.	NM-Germany Article no.	NM-Germany Article no.	NM-Germany Article no.	NM-Germany Article no.	
	LBSRN40648GF	LBRN40648GF	KBSRN40648G	KBRN40648G	KRRN40648G	ORRN40648G		

**DIESEL**

ENGINE TYPE Motortyp Type de Moteur Tipo de motor Тип двигателя	LINER KIT Liner Kit Kit de Chemise Camisas de los cilindros лайнер комплект	CYL. LINER Zylinderlaufbuchse Chemise Camisas de los cilindros втулка цилиндра	PISTON + RINGS Kolben + Ringe Piston + Segments Pistón Set Поршень и кольца			PISTON SET Kolben Set Set de Piston Pistón Set поршневой	RINGS SET Kolben Set Segments de Piston Anillos Set кольца	PIN Pin Axe Perno Пин
<b>K9K 702/710</b> <b>K9K 724/752</b> <b>K9K 760/764</b> 4 Cyl 76.0 mm Bore Ø 1,461 cc 	<b>(A)</b> consists of (C)	(C)	(D)			alfin skirt MOS2 treated fits tapered con. rod	Top: 2.0	Ø: 25.0 Length: 60.0
		Length: 145.0	143.5	Length: 66.0			2nd: 2.0	
		Outside Ø: 80.5	79.5	Comp: 41.78			3rd: 2.5	
		Flange Ø: 84.5	81.5	Height: -3.7		1st oil: 2.5		
		flange depth 5.0	4.0	-14.0		2nd oil:		
			<b>Reference no.:</b>	<b>Reference no.:</b>	<b>Reference no.:</b>	<b>Reference no.:</b>	<b>O-RING</b>	
				<b>A-A350603</b> <b>K-40465600</b> <b>N-8712340000</b>		<b>77 01 473 144</b> <b>77 01 478 755</b> <b>A-R60620</b> <b>G-0812340000</b> <b>K-800044540000</b> <b>M-02201N0</b>		
NM-Germany Article no. Artikelnummer/ Modelo Número / статья НОМЕР	NM-Germany Article no.	NM-Germany Article no.	NM-Germany Article no.	NM-Germany Article no.	NM-Germany Article no.	NM-Germany Article no.	NM-Germany Article no.	
	LBSRN40649DSA (A)	LBRN406491DSA (C) LBRN406492DSA (D)	KBSRN40649DA	KBRN40649DA	KRRN40649DA			

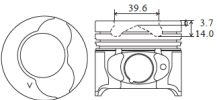
**DIESEL**

ENGINE TYPE Motortyp Type de Moteur Tipo de motor Тип двигателя	LINER KIT Liner Kit Kit de Chemise Camisas de los cilindros лайнер комплект	CYL. LINER Zylinderlaufbuchse Chemise Camisas de los cilindros втулка цилиндра	PISTON + RINGS Kolben + Ringe Piston + Segments Pistón Set Поршень и кольца			PISTON SET Kolben Set Set de Piston Pistón Set поршневой	RINGS SET Kolben Set Segments de Piston Anillos Set кольца	PIN Pin Axe Perno Пин
<b>K9K 702/710</b> <b>K9K 724/752</b> <b>K9K 760/764</b> 4 Cyl 76.0 mm Bore Ø 1,461 cc 	<b>(A)</b> consists of (C)	(C)	(D)			alfin skirt MOS2 treated fits tapered con. rod	Top: 2.0	Ø: 26.0 Length: 60.0
		Length: 145.0	143.5	Length: 66.0			2nd: 2.0	
		Outside Ø: 80.5	79.5	Comp: 41.78			3rd: 2.5	
		Flange Ø: 84.5	81.5	Height: -3.7		1st oil: 2.5		
		flange depth 5.0	4.0	-14.0		2nd oil:		
			<b>Reference no.:</b>	<b>Reference no.:</b>	<b>Reference no.:</b>	<b>Reference no.:</b>	<b>O-RING</b>	
				<b>A-A354068</b> <b>K-40190600</b> <b>M-0220100</b> <b>N-8712340010</b>		<b>77 01 473 144</b> <b>77 01 478 755</b> <b>A-R60620</b> <b>G-0812340000</b> <b>K-800044540000</b> <b>M-02201N0</b>		
NM-Germany Article no. Artikelnummer/ Modelo Número / статья НОМЕР	NM-Germany Article no.	NM-Germany Article no.	NM-Germany Article no.	NM-Germany Article no.	NM-Germany Article no.	NM-Germany Article no.	NM-Germany Article no.	
	LBSRN40650DSA (A)	LBRN406501DSA (C) LBRN406502DSA (D)	KBSRN40650DA	KBRN40650DA	KRRN40650DA			



ENGINE TYPE Motortyp Type de Moteur Tipo de motor Тип двигателя	LINER KIT Liner Kit Kit de Chemise Camisas de los cilindros лайнер комплект	CYL. LINER Zylinderlaufbuchse Chemise Camisas de los cilindros втулка цилиндра	PISTON + RINGS Kolben + Ringe Piston + Segments Pistón Set Поршень и кольца		PISTON SET Kolben Set Set de Piston Pistón Set поршневой	RINGS SET Kolben Set Segments de Piston Anillos Set кольца	PIN Pin Axe Perno Пин								
<b>K9K 732/764</b> <b>K9K 780/804</b> <b>K9K 806</b> 4 Cyl 76.0 mm Bore Ø 1,461 cc	(A) consists of (C)	(C) (D)	Length:	145.0	143.5	Length:	66.0	alfin and with oil gallery skirt MOS2 treated fits tapered con. rod	Top:	2.0	Ø: 26.0 Length: 60.0				
		Outside Ø:	80.5	79.5	Comp:	41.7	Flange Ø:		84.5	81.5		Height:	-4.0	2nd:	2.0
		Flange depth	5.0	4.0										1st oil:	2.5
		Reference no.:	Reference no.:	Reference no.:	Reference no.:	O-RING									
			77 01 476 563 N-8712340030	82 00 405 107	77 01 473 144 77 01 478 755 A-R60620 G-0812340000 K-800044540000 M-02201N0										
NM-Germany Article no. Artikelnummer/ Modelo Número / статья НОМЕР	NM-Germany Article no.	NM-Germany Article no.	NM-Germany Article no.	NM-Germany Article no.	NM-Germany Article no.	NM-Germany Article no.	NM-Germany Article no.								
	LBSRN40651DSA (A)	LBRN406511DSA (C) LBRN406512DSA (D)	KBSRN40651DA	KBRN40651DA	KRRN40651DA										

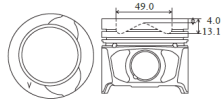

## DIESEL

ENGINE TYPE Motortyp Type de Moteur Tipo de motor Тип двигателя	LINER KIT Liner Kit Kit de Chemise Camisas de los cilindros лайнер комплект	CYL. LINER Zylinderlaufbuchse Chemise Camisas de los cilindros втулка цилиндра	PISTON + RINGS Kolben + Ringe Piston + Segments Pistón Set Поршень и кольца		PISTON SET Kolben Set Set de Piston Pistón Set поршневой	RINGS SET Kolben Set Segments de Piston Anillos Set кольца	PIN Pin Axe Perno Пин								
<b>K9K 712/718/724</b> <b>K9K 728/729/760</b> <b>K9K 766/802</b> 4 Cyl 76.0 mm Bore Ø 1,461 cc	(A) consists of (C)	(C) (D)	Length:	145.0	143.5	Length:	66.0	alfin and with oil gallery skirt MOS2 treated fits tapered con. rod	Top:	2.0	Ø: 26.0 Length: 60.0				
		Outside Ø:	80.5	79.5	Comp:	41.7	Flange Ø:		84.5	81.5		Height:	-3.7	2nd:	2.0
		Flange depth	5.0	4.0										1st oil:	2.5
		Reference no.:	Reference no.:	Reference no.:	Reference no.:	O-RING									
			12 0A 163 32R N-8712340020	77 01 475 355	77 01 473 144 77 01 478 755 A-R60620 G-0812340000 K-800044540000 M-02201N0										
NM-Germany Article no. Artikelnummer/ Modelo Número / статья НОМЕР	NM-Germany Article no.	NM-Germany Article no.	NM-Germany Article no.	NM-Germany Article no.	NM-Germany Article no.	NM-Germany Article no.	NM-Germany Article no.								
	LBSRN40652DSA (A)	LBRN406521DSA (C) LBRN406522DSA (D)	KBSRN40652DA	KBRN40652DA	KRRN40652DA										

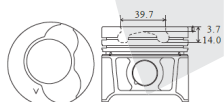

RENAULT

## GASOLINE

ENGINE TYPE Motortyp Type de Moteur Tipo de motor Тип двигателя	LINER KIT Liner Kit Kit de Chemise Camisas de los cilindros лайнер комплект	CYL. LINER Zylinderlaufbuchse Chemise Camisas de los cilindros втулка цилиндра	PISTON + RINGS Kolben + Ringe Piston + Segments Pistón Set Поршень и кольца		PISTON SET Kolben Set Set de Piston Pistón Set поршневой	RINGS SET Kolben Set Segments de Piston Anillos Set кольца	PIN Pin Axe Perno Пин								
<b>C1J.715</b> <b>C2J.784</b> 4 Cyl 76.0 mm Bore Ø 1,397 cc	77 01 458 246 77 01 461 246 77 01 462 153 77 01 462 263 77 01 462 494 77 01 465 263 77 01 465 872 A-SA2516 K-9369670 M-0217880 N-8933350000	(C) (D)	Length:	134.0		Length:	64.0		Top:	1.75	Ø: 20.0 Length: 64.0				
		Outside Ø:	80.52		Comp:	37.4	Flange Ø:		90.15	Height:		0	2nd:	2.0	
		collar depth	95.0											3rd:	4.0
		Reference no.:	Reference no.:	Reference no.:	Reference no.:	O-RING									
		A-SJ4326 G-1563082000 K-89060110 M-021WN23	K-93696700 M-0217810	77 01 458 697	A-R66190 G-0833350000 K-800023040000 M-02178N0										
NM-Germany Article no. Artikelnummer/ Modelo Número / статья НОМЕР	NM-Germany Article no.	NM-Germany Article no.	NM-Germany Article no.	NM-Germany Article no.	NM-Germany Article no.	NM-Germany Article no.	NM-Germany Article no.								
	LBSRN40653GF	LBRN40653GF	KBSRN40653G	KBRN40653G	KRRN40653G	ORRN40653G									

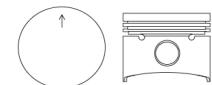

**GASOLINE**

ENGINE TYPE Motortyp Type de Moteur Tipo de motor Тип двигателя	LINER KIT Liner Kit Kit de Chemise Camisas de los cilindros лайнер комплект	CYL. LINER Zylinderlaufbuchse Chemise Camisas de los cilindros втулка цилиндра	PISTON + RINGS Kolben + Ringe Piston + Segments Pistón Set Поршень и кольца			PISTON SET Kolben Set Set de Piston Pistón Set поршень	RINGS SET Kolben Set Segments de Piston Anillos Set кольца	PIN Pin Axe Perno Пин				
<b>C3L</b> 4 Cyl 77.0 mm Bore Ø 1,565 cc	<b>M-K18771</b>	Length: 134.0 Outside Ø: 81.0 Flange Ø: 90.2 collar depth 95.0	Length: 60.6 Comp: 34.0 Height: -1.9			Top: 1.75 2nd: 2.0 3rd: 4.0 1st oil: 4.0 2nd oil:	Ø: 20.0 Length: 64.0					
								Reference no.:	Reference no.:	Reference no.:	Reference no.:	O-RING
								<b>M-C18771</b>	<b>M-S18771</b>	<b>M-E18771</b>	<b>A-R66250</b> <b>G-0833450000</b> <b>M-02131V0</b> <b>M-A59109</b>	
NM-Germany Article no. Artikelnummer/ Modelo Número / статья НОМЕР	NM-Germany Article no.	NM-Germany Article no.	NM-Germany Article no.	NM-Germany Article no.	NM-Germany Article no.	NM-Germany Article no.	NM-Germany Article no.					
	<b>LBSRN40654GF</b>	<b>LBRN40654GF</b>	<b>KBSRN40654G</b>	<b>KBRN40654G</b>	<b>KRRN40654G</b>	<b>ORRN40654G</b>						

**GASOLINE**

ENGINE TYPE Motortyp Type de Moteur Tipo de motor Тип двигателя	LINER KIT Liner Kit Kit de Chemise Camisas de los cilindros лайнер комплект	CYL. LINER Zylinderlaufbuchse Chemise Camisas de los cilindros втулка цилиндра	PISTON + RINGS Kolben + Ringe Piston + Segments Pistón Set Поршень и кольца			PISTON SET Kolben Set Set de Piston Pistón Set поршень	RINGS SET Kolben Set Segments de Piston Anillos Set кольца	PIN Pin Axe Perno Пин				
<b>A1M A2M</b> <b>841/841.25/841.26</b> 4 Cyl 79.0 mm Bore Ø 1,647 cc	<b>A-SA2499</b> <b>K-93697960</b> <b>M-0217990</b> <b>N-8933430000</b>	Length: 144.0 Outside Ø: 84.0 Flange Ø: 95.9 collar depth 92.6	Length: 65.9 Comp: 40.5 Height: 0			Top: 1.75 2nd: 2.0 3rd: 4.0 1st oil: 4.0 2nd oil:	Ø: 21.0 Length: 69.0					
								Reference no.:	Reference no.:	Reference no.:	Reference no.:	O-RING
								<b>K-88888110</b> <b>M-021WN14</b>	<b>K-93697600</b> <b>M-0217900</b>		<b>A-R66270</b> <b>G-0833430000</b> <b>M-02179N0</b>	
NM-Germany Article no. Artikelnummer/ Modelo Número / статья НОМЕР	NM-Germany Article no.	NM-Germany Article no.	NM-Germany Article no.	NM-Germany Article no.	NM-Germany Article no.	NM-Germany Article no.	NM-Germany Article no.					
	<b>LBSRN40655GF</b>	<b>LBRN40655GF</b>	<b>KBSRN40655G</b>	<b>KBRN40655G</b>	<b>KRRN40655G</b>	<b>ORRN40655G</b>						

**GASOLINE**

ENGINE TYPE Motortyp Type de Moteur Tipo de motor Тип двигателя	LINER KIT Liner Kit Kit de Chemise Camisas de los cilindros лайнер комплект	CYL. LINER Zylinderlaufbuchse Chemise Camisas de los cilindros втулка цилиндра	PISTON + RINGS Kolben + Ringe Piston + Segments Pistón Set Поршень и кольца			PISTON SET Kolben Set Set de Piston Pistón Set поршень	RINGS SET Kolben Set Segments de Piston Anillos Set кольца	PIN Pin Axe Perno Пин				
<b>K4M</b> <b>700/701/704/706</b> <b>K4M</b> <b>708/709/710/711</b> 4 Cyl 79.5 mm Bore Ø 1,598 cc		Length: 55.0 Outside Ø: 31.7 Flange Ø: -1.3 flange depth	Length: 54.75 Comp: 31.7 Height: -1.3	STD	O/S	Top: 1.5 2nd: 1.5 3rd: 2.5 1st oil: 2nd oil:	Ø: 20.0 Length: 62.0					
								Reference no.:	Reference no.:	Reference no.:	Reference no.:	O-RING
									<b>A-24244</b> <b>K-99746600</b> <b>M-0220600</b> <b>N-8710420030</b>	<b>77 01 474 854</b> <b>77 01 474 855</b> <b>77 01 474 856</b>	<b>77 01 473 223</b> <b>77 01 474 857</b> <b>A-R60240</b> <b>G-0810420000</b> <b>K-800053040000</b> <b>M-02202N0</b>	
NM-Germany Article no. Artikelnummer/ Modelo Número / статья НОМЕР	NM-Germany Article no.	NM-Germany Article no.	NM-Germany Article no.	NM-Germany Article no.	NM-Germany Article no.	NM-Germany Article no.	NM-Germany Article no.					
			<b>KBSRN40656G</b>	<b>KBRN40656G</b>	<b>KRRN40656G</b>							

**GASOLINE**

ENGINE TYPE Motortyp Type de Moteur Tipo de motor Тип двигателя	LINER KIT Liner Kit Kit de Chemise Camisas de los cilindros лайнер комплект	CYL. LINER Zylinderlaufbuchse Chemise Camisas de los cilindros втулка цилиндра	PISTON + RINGS Kolben + Ringe Piston + Segments Pistón Set Поршень и кольца		PISTON SET Kolben Set Set de Piston Pistón Set поршневой	RINGS SET Kolben Set Segments de Piston Anillos Set кольца	PIN Pin Axe Perno Пин	
<b>K4J 713/730 K4J 740/750 K4J 770/780</b> 4 Cyl 79.5 mm Bore Ø 1,390 cc		Length: Outside Ø: Flange Ø: flange depth	Length:	64.5		Top:	1.5	Ø: 20.0 Length: 62.0
			Comp:	37.2		2nd:	1.5	
			Height:	-1.4		3rd:	2.5	
			Reference no.:	Reference no.:	Reference no.:	Reference no.:	O-RING	
				K-40015600 M-0220500	77 01 474 903 77 01 474 904 77 01 474 905	77 01 473 223 77 01 474 857 A-R60240 G-0810420000 K-800053040000 M-02202N0		
NM-Germany Article no. Artikelnummer/ Modelo Número / статья НОМЕР	NM-Germany Article no.	NM-Germany Article no.	NM-Germany Article no.	NM-Germany Article no.	NM-Germany Article no.	NM-Germany Article no.	NM-Germany Article no.	
				KBSRN40657G	KBRN40657G	KRRN40657G		

**GASOLINE**

ENGINE TYPE Motortyp Type de Moteur Tipo de motor Тип двигателя	LINER KIT Liner Kit Kit de Chemise Camisas de los cilindros лайнер комплект	CYL. LINER Zylinderlaufbuchse Chemise Camisas de los cilindros втулка цилиндра	PISTON + RINGS Kolben + Ringe Piston + Segments Pistón Set Поршень и кольца		PISTON SET Kolben Set Set de Piston Pistón Set поршневой	RINGS SET Kolben Set Segments de Piston Anillos Set кольца	PIN Pin Axe Perno Пин	
<b>K7M 702/703 K7M 710/744 K7M 745/746 K7M 790</b> (for cyl 1/2) (for cyl 3/4) Cyl 79.5 mm Bore Ø 1,598 cc		Length: Outside Ø: Flange Ø: flange depth	Length:	56.3		Top:	1.5	Ø: 19.0 Length: 64.0
			Comp:	29.25		2nd:	1.5	
			Height:	2.55		3rd:	2.5	
			Reference no.:	Reference no.:	Reference no.:	Reference no.:	O-RING	
				(for cyl 1/2) A-24136 K-40306600 M-0220200 N-8710420000  (for cyl 3/4) A-24137 K-40311600 M-0220300 N-8710420010	(for cyl 1/2) 77 01 700 666 77 01 700 667 77 01 700 668  (for cyl 3/4) 77 01 700 670 77 01 700 671 77 01 700 672	77 01 473 223 77 01 474 857 A-R60240 G-0810420000 K-800053040000 M-02202N0		
NM-Germany Article no. Artikelnummer/ Modelo Número / статья НОМЕР	NM-Germany Article no.	NM-Germany Article no.	NM-Germany Article no.	NM-Germany Article no.	NM-Germany Article no.	NM-Germany Article no.	NM-Germany Article no.	
				KBSRN12340658G	KBRN12340658G	KRRN12340658G		

RENAULT

**GASOLINE**

ENGINE TYPE Motortyp Type de Moteur Tipo de motor Тип двигателя	LINER KIT Liner Kit Kit de Chemise Camisas de los cilindros лайнер комплект	CYL. LINER Zylinderlaufbuchse Chemise Camisas de los cilindros втулка цилиндра	PISTON + RINGS Kolben + Ringe Piston + Segments Pistón Set Поршень и кольца		PISTON SET Kolben Set Set de Piston Pistón Set поршневой	RINGS SET Kolben Set Segments de Piston Anillos Set кольца	PIN Pin Axe Perno Пин			
<b>K4M</b> 4 Cyl 79.5 mm Bore Ø 1,598 cc		Length: Outside Ø: Flange Ø: flange depth	Length:	55.0	STD	O/S		Top:	1.5	Ø: 20.0 Length: 62.0
			Comp:	31.7	31.45	2nd:		1.5		
			Height:	-1.3	-1.3	3rd:		2.5		
			Reference no.:	Reference no.:	Reference no.:	Reference no.:	O-RING			
					77 01 713 104	77 01 473 223 77 01 474 857 A-R60240 G-0810420000 K-800053040000 M-02202N0				
NM-Germany Article no. Artikelnummer/ Modelo Número / статья НОМЕР	NM-Germany Article no.	NM-Germany Article no.	NM-Germany Article no.	NM-Germany Article no.	NM-Germany Article no.	NM-Germany Article no.	NM-Germany Article no.			
				KBSRN40659G	KBRN40659G	KRRN40659G				

**GASOLINE**

ENGINE TYPE Motortyp Type de Moteur Tipo de motor Тип двигателя	LINER KIT Liner Kit Kit de Chemise Camisas de los cilindros лайнер комплект	CYL. LINER Zylinderlaufbuchse Chemise Camisas de los cilindros втулка цилиндра	PISTON + RINGS Kolben + Ringe Piston + Segments Pistón Set Поршень и кольца			PISTON SET Kolben Set Set de Piston Pistón Set поршень	RINGS SET Kolben Set Segments de Piston Anillos Set кольца	PIN Pin Axe Perno Пин				
<b>K7J 710</b> <b>K7J 714</b> 4 Cyl 79.5 mm Bore Ø 1,390 cc		Length: Outside Ø: Flange Ø: flange depth	Length: Comp: Height:	57.0 34.8 0		Top: 1.5 2nd: 1.5 3rd: 1.5 1st oil: 2.5 2nd oil:	Ø: 19.0 Length: 62.0					
								Reference no.:	Reference no.:	Reference no.:	Reference no.:	O-RING
									<b>K-40277600</b>		<b>77 01 473 223</b> <b>77 01 474 857</b> <b>A-R60240</b> <b>G-0810420000</b> <b>K-800053040000</b> <b>M-02202N0</b>	
NM-Germany Article no. Artikelnummer/ Modelo Número / статья НОМЕР	NM-Germany Article no.	NM-Germany Article no.	NM-Germany Article no.	NM-Germany Article no.	NM-Germany Article no.	NM-Germany Article no.	NM-Germany Article no.					
			<b>KBSRN40660G</b>	<b>KBRN40660G</b>	<b>KRRN40660G</b>							

**GASOLINE**

ENGINE TYPE Motortyp Type de Moteur Tipo de motor Тип двигателя	LINER KIT Liner Kit Kit de Chemise Camisas de los cilindros лайнер комплект	CYL. LINER Zylinderlaufbuchse Chemise Camisas de los cilindros втулка цилиндра	PISTON + RINGS Kolben + Ringe Piston + Segments Pistón Set Поршень и кольца			PISTON SET Kolben Set Set de Piston Pistón Set поршень	RINGS SET Kolben Set Segments de Piston Anillos Set кольца	PIN Pin Axe Perno Пин				
<b>K7M</b> 4 Cyl 79.5 mm Bore Ø 1,598 cc		Length: Outside Ø: Flange Ø: flange depth	Length: Comp: Height:	51.2 28.3 0	top and 2nd ring lands anodized	Top: 1.2 2nd: 1.5 3rd: 1.5 1st oil: 2.5 2nd oil:	Ø: 20.0 Length: 54.0					
								Reference no.:	Reference no.:	Reference no.:	Reference no.:	O-RING
											<b>A-R60660</b> <b>G-0810520000</b> <b>M-02215N0</b>	
NM-Germany Article no. Artikelnummer/ Modelo Número / статья НОМЕР	NM-Germany Article no.	NM-Germany Article no.	NM-Germany Article no.	NM-Germany Article no.	NM-Germany Article no.	NM-Germany Article no.	NM-Germany Article no.					
			<b>KBSRN40661G</b>	<b>KBRN40661G</b>	<b>KRRN40661G</b>							

**DIESEL**

ENGINE TYPE Motortyp Type de Moteur Tipo de motor Тип двигателя	LINER KIT Liner Kit Kit de Chemise Camisas de los cilindros лайнер комплект	CYL. LINER Zylinderlaufbuchse Chemise Camisas de los cilindros втулка цилиндра	PISTON + RINGS Kolben + Ringe Piston + Segments Pistón Set Поршень и кольца			PISTON SET Kolben Set Set de Piston Pistón Set поршень	RINGS SET Kolben Set Segments de Piston Anillos Set кольца	PIN Pin Axe Perno Пин				
<b>38.0</b> <b>F9Q 718</b> <b>F9Q 730</b> <b>F9Q 780</b> 4 Cyl 80.0 mm Bore Ø 1,870 cc		Length: 154.0 Outside Ø: 83.05 Flange Ø: 86.0 flange depth 5.0	Length: 77.4 Comp: 47.06 Height: -5.4 -17.8		alfin skirt MOS2 treated fits tapered con. rod	Top: 2.5 2nd: 2.0 3rd: 3.0 1st oil: 3.0 2nd oil:	Ø: 28.0 Length: 60.0					
								Reference no.:	Reference no.:	Reference no.:	Reference no.:	O-RING
									<b>K-99561600</b> <b>M-0215800</b>	<b>77 01 472 833</b> <b>77 01 472 834</b> <b>77 01 472 835</b>	<b>A-R60260</b> <b>G-0810150000</b> <b>K-800036140000</b> <b>M-02158V0</b>	
NM-Germany Article no. Artikelnummer/ Modelo Número / статья НОМЕР	NM-Germany Article no.	NM-Germany Article no.	NM-Germany Article no.	NM-Germany Article no.	NM-Germany Article no.	NM-Germany Article no.	NM-Germany Article no.					
	<b>LBSRN40662DSA</b>	<b>LBRN40662DSA</b>	<b>KBSRN40662DA</b>	<b>KBRN40662DA</b>	<b>KRRN40662DA</b>							

**DIESEL**

ENGINE TYPE Motortyp Type de Moteur Tipo de motor Тип двигателя	LINER KIT Liner Kit Kit de Chemise Camisas de los cilindros лайнер комплект	CYL. LINER Zylinderlaufbuchse Chemise Camisas de los cilindros втулка цилиндра	PISTON + RINGS Kolben + Ringe Piston + Segments Pistón Set Поршень и кольца		PISTON SET Kolben Set Set de Piston Pistón Set поршневой	RINGS SET Kolben Set Segments de Piston Anillos Set кольца	PIN Pin Axe Perno Пин
<b>F9Q 650/750/756/758</b> <b>F9Q 800/812/816/818</b> <b>F9Q 820/826</b> 4 Cyl 80.0 mm Bore Ø 1,870 cc		Length: 154.0	Length: 77.0	alfin and with oil gallery skirt MOS2 treated fits tapered con. rod	Top: 2.5	Ø: 28.0 Length: 60.0	
		Outside Ø: 83.05	Comp: 47.04		2nd: 2.0		
		Flange Ø: 86.0	Height: -5.5		3rd: 3.0		
		flange depth 5.0	-17.8		1st oil: 3.0		
		Reference no.:		Reference no.:	Reference no.:	Reference no.:	O-RING
			<b>K-99780600</b> <b>N-8742230000</b>			<b>A-R60260</b> <b>G-0810150000</b> <b>K-800036140000</b> <b>M-02158V0</b>	
NM-Germany Article no. Artikelnummer/ Modelo Número / статья НОМЕР	NM-Germany Article no.	NM-Germany Article no.	NM-Germany Article no.	NM-Germany Article no.	NM-Germany Article no.	NM-Germany Article no.	NM-Germany Article no.
	LBSRN40663DSB	LBRN40663DSB	KBSRN40663DB	KBRN40663DB	KRRN40663DB		

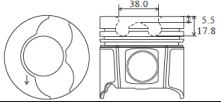

**DIESEL**

ENGINE TYPE Motortyp Type de Moteur Tipo de motor Тип двигателя	LINER KIT Liner Kit Kit de Chemise Camisas de los cilindros лайнер комплект	CYL. LINER Zylinderlaufbuchse Chemise Camisas de los cilindros втулка цилиндра	PISTON + RINGS Kolben + Ringe Piston + Segments Pistón Set Поршень и кольца		PISTON SET Kolben Set Set de Piston Pistón Set поршневой	RINGS SET Kolben Set Segments de Piston Anillos Set кольца	PIN Pin Axe Perno Пин
<b>F8QT 610</b> <b>F8QT 784</b> <b>F8QT 785</b> 4 Cyl 80.0 mm Bore Ø 1,870 cc		Length: 154.0	Length: 66.69	alfin and with oil gallery	Top: 2.5	Ø: 26.0 Length: 66.5	
		Outside Ø: 83.05	Comp: 41.71		2nd: 2.0		
		Flange Ø: 86.0	Height: -0.8		3rd: 3.0		
		flange depth 5.0	-1.7		1st oil: 3.0		
		Reference no.:		Reference no.:	Reference no.:	Reference no.:	O-RING
			<b>A-A350542</b> <b>N-8710350000</b>			<b>A-R60260</b> <b>G-0810150000</b> <b>K-800036140000</b> <b>M-02158V0</b>	
NM-Germany Article no. Artikelnummer/ Modelo Número / статья НОМЕР	NM-Germany Article no.	NM-Germany Article no.	NM-Germany Article no.	NM-Germany Article no.	NM-Germany Article no.	NM-Germany Article no.	NM-Germany Article no.
	LBSRN40664DSB	LBRN40664DSB	KBSRN40664DB	KBRN40664DB	KRRN40664DB		





RENAULT

**DIESEL**



ENGINE TYPE Motortyp Type de Moteur Tipo de motor Тип двигателя	LINER KIT Liner Kit Kit de Chemise Camisas de los cilindros лайнер комплект	CYL. LINER Zylinderlaufbuchse Chemise Camisas de los cilindros втулка цилиндра	PISTON + RINGS Kolben + Ringe Piston + Segments Pistón Set Поршень и кольца		PISTON SET Kolben Set Set de Piston Pistón Set поршневой	RINGS SET Kolben Set Segments de Piston Anillos Set кольца	PIN Pin Axe Perno Пин
<b>F8Q 606/620/640/644</b> <b>F8Q 648/672/676/678</b> <b>F8Q 682/692/696/704</b> <b>F8Q 706/710/714/722</b> <b>F8Q 724/730/742/764</b> 4 Cyl 80.0 mm Bore Ø 1,870 cc		Length: 154.0	Length: 67.4	alfin	Top: 2.0	Ø: 24.0 Length: 63.0	
		Outside Ø: 83.05	Comp: 42.5		2nd: 2.0		
		Flange Ø: 86.0	Height: -0.7		3rd: 3.0		
		flange depth 5.0			1st oil: 3.0		
		Reference no.:		Reference no.:	Reference no.:	Reference no.:	O-RING
			<b>K-92006800</b> <b>M-0219300</b> <b>M-0219310</b>			<b>77 01 471 716</b> <b>77 01 473 009</b> <b>A-R66330</b> <b>G-0833650000</b> <b>K-800023240000</b> <b>M-02193N0</b>	
NM-Germany Article no. Artikelnummer/ Modelo Número / статья НОМЕР	NM-Germany Article no.	NM-Germany Article no.	NM-Germany Article no.	NM-Germany Article no.	NM-Germany Article no.	NM-Germany Article no.	NM-Germany Article no.
	LBSRN40665DSA	LBRN40665DSA	KBSRN40665DA	KBRN40665DA	KRRN40665DA		





**DIESEL**

ENGINE TYPE Motortyp Type de Moteur Tipo de motor Тип двигателя	LINER KIT Liner Kit Kit de Chemise Camisas de los cilindros лайнер комплект	CYL. LINER Zylinderlaufbuchse Chemise Camisas de los cilindros втулка цилиндра	PISTON + RINGS Kolben + Ringe Piston + Segments Pistón Set Поршень и кольца		PISTON SET Kolben Set Set de Piston Pistón Set поршневой	RINGS SET Kolben Set Segments de Piston Anillos Set кольца	PIN Pin Axe Perno Пин
<b>F8Q 630</b> <b>F8Q 632</b> <b>F8Q 662</b> 4 Cyl 80.0 mm Bore Ø 1,870 cc 	<b>PKRN408005D</b>	Length: 154.0	Length: 67.1	alfin	Top: 2.0	Ø: 24.0	
		Outside Ø: 83.05	Comp: 42.2		2nd: 2.0		
		Flange Ø: 86.0	Height: -4.5		3rd: 2.0		
		flange depth 5.0			1st oil: 3.0	Length: 63.0	
		<b>Reference no.:</b>	<b>Reference no.:</b>	<b>Reference no.:</b>	<b>Reference no.:</b>	<b>O-RING</b>	
			<b>K-40070600</b>	<b>PTRN408005DA</b>	<b>77 01 471 716</b> <b>77 01 473 009</b> <b>A-R66330</b> <b>G-0833650000</b> <b>K-800023240000</b> <b>M-02193N0</b>		
NM-Germany Article no. Artikelnummer/ Modelo Número / статья НОМЕР	NM-Germany Article no.	NM-Germany Article no.	NM-Germany Article no.	NM-Germany Article no.	NM-Germany Article no.	NM-Germany Article no.	
	<b>LBSRN40666DSA</b> <b>LBSRN40666DSA</b>	<b>LBRN40666DSA</b>	<b>KBSRN40666DA</b> <b>KBSRN40666DA</b>	<b>KBRN40666DA</b> <b>KBRN40666DA</b>	<b>KRRN40666DA</b>		

**DIESEL**

ENGINE TYPE Motortyp Type de Moteur Tipo de motor Тип двигателя	LINER KIT Liner Kit Kit de Chemise Camisas de los cilindros лайнер комплект	CYL. LINER Zylinderlaufbuchse Chemise Camisas de los cilindros втулка цилиндра	PISTON + RINGS Kolben + Ringe Piston + Segments Pistón Set Поршень и кольца		PISTON SET Kolben Set Set de Piston Pistón Set поршневой	RINGS SET Kolben Set Segments de Piston Anillos Set кольца	PIN Pin Axe Perno Пин
<b>R9M</b> 4 Cyl 80.0 mm Bore Ø 1,598 cc 		Length:	Length:	alfin and with oil gallery	Top:	Ø:	
		Outside Ø:	Comp:		2nd:		
		Flange Ø:	Height:		3rd:		
		flange depth			1st oil:	Length:	
					2nd oil:		
		<b>Reference no.:</b>	<b>Reference no.:</b>	<b>Reference no.:</b>	<b>Reference no.:</b>	<b>O-RING</b>	
NM-Germany Article no. Artikelnummer/ Modelo Número / статья НОМЕР	NM-Germany Article no.	NM-Germany Article no.	NM-Germany Article no.	NM-Germany Article no.	NM-Germany Article no.	NM-Germany Article no.	
			<b>KBSRN40667DB</b>	<b>KBRN40667DB</b>			

**DIESEL**

ENGINE TYPE Motortyp Type de Moteur Tipo de motor Тип двигателя	LINER KIT Liner Kit Kit de Chemise Camisas de los cilindros лайнер комплект	CYL. LINER Zylinderlaufbuchse Chemise Camisas de los cilindros втулка цилиндра	PISTON + RINGS Kolben + Ringe Piston + Segments Pistón Set Поршень и кольца		PISTON SET Kolben Set Set de Piston Pistón Set поршневой	RINGS SET Kolben Set Segments de Piston Anillos Set кольца	PIN Pin Axe Perno Пин
<b>F8Q 630</b> <b>F8Q 632</b> <b>F8Q 662</b> 4 Cyl 80.0 mm Bore Ø 1,870 cc 		Length: 154.0	Length: 67.2	alfin	Top: 2.0	Ø: 24.0	
		Outside Ø: 83.05	Comp: 42.2		2nd: 2.0		
		Flange Ø: 86.0	Height: -1.6		3rd: 2.0		
		flange depth 5.0			1st oil: 3.0	Length: 63.0	
					2nd oil:		
		<b>Reference no.:</b>	<b>Reference no.:</b>	<b>Reference no.:</b>	<b>Reference no.:</b>	<b>O-RING</b>	
			<b>M-0219100</b>		<b>77 01 471 716</b> <b>77 01 473 009</b> <b>A-R66330</b> <b>G-0833650000</b> <b>K-800023240000</b> <b>M-02193N0</b>		
NM-Germany Article no. Artikelnummer/ Modelo Número / статья НОМЕР	NM-Germany Article no.	NM-Germany Article no.	NM-Germany Article no.	NM-Germany Article no.	NM-Germany Article no.	NM-Germany Article no.	
	<b>LBSRN40668DSA</b>	<b>LBRN40668DSA</b>	<b>KBSRN40668DA</b>	<b>KBRN40668DA</b>	<b>KRRN40668DA</b>		

**GASOLINE**

ENGINE TYPE Motortyp Type de Moteur Tipo de motor Тип двигателя	LINER KIT Liner Kit Kit de Chemise Camisas de los cilindros лайнер комплект	CYL. LINER Zylinderlaufbuchse Chemise Camisas de los cilindros втулка цилиндра	PISTON + RINGS Kolben + Ringe Piston + Segments Pistón Set Поршень и кольца			PISTON SET Kolben Set Set de Piston Pistón Set поршневой	RINGS SET Kolben Set Segments de Piston Anillos Set кольца	PIN Pin Axe Perno Пин
<b>F2N F3N</b> 4 Cyl 81.0 mm Bore Ø 1,721 cc		Length: Outside Ø: Flange Ø: flange depth	Length: Comp: Height:	70.2 44.2 -14.25		Top: 1.75	Ø: 21.0 Length: 65.0	
						2nd: 2.0		
						3rd: 3.0 1st oil: 2nd oil:		
	Reference no.:	Reference no.:	Reference no.:	Reference no.:	O-RING			
			<b>K-90364600</b> <b>M-0218300</b> <b>M-0219500</b> <b>M-0219600</b>			<b>A-R66260</b> <b>G-0833510000</b> <b>K-800023340000</b> <b>M-02182N0</b>		
NM-Germany Article no. Artikelnummer/ Modelo Número / статья НОМЕР	NM-Germany Article no.	NM-Germany Article no.	NM-Germany Article no.	NM-Germany Article no.	NM-Germany Article no.	NM-Germany Article no.	NM-Germany Article no.	
			<b>KBSRN40669G</b>	<b>KBRN40669G</b>	<b>KRRN40669G</b>			

ENGINE TYPE Motortyp Type de Moteur Tipo de motor Тип двигателя	LINER KIT Liner Kit Kit de Chemise Camisas de los cilindros лайнер комплект	CYL. LINER Zylinderlaufbuchse Chemise Camisas de los cilindros втулка цилиндра	PISTON + RINGS Kolben + Ringe Piston + Segments Pistón Set Поршень и кольца			PISTON SET Kolben Set Set de Piston Pistón Set поршневой	RINGS SET Kolben Set Segments de Piston Anillos Set кольца	PIN Pin Axe Perno Пин
<b>F3P 682</b> 4 Cyl 82.7 mm Bore Ø 1,783 cc		Length: Outside Ø: Flange Ø: flange depth	Length: Comp: Height:	61.7 35.4 -6.7		Top: 1.5	Ø: 21.0 Length: 57.0	
						2nd: 1.75		
						3rd: 3.0 1st oil: 2nd oil:		
	Reference no.:	Reference no.:	Reference no.:	Reference no.:	O-RING			
				<b>77 01 685 394</b> <b>77 01 685 395</b>		<b>77 01 467 662</b> <b>A-R67580</b> <b>G-0833740000</b> <b>M-02162N0</b>		
NM-Germany Article no. Artikelnummer/ Modelo Número / статья НОМЕР	NM-Germany Article no.	NM-Germany Article no.	NM-Germany Article no.	NM-Germany Article no.	NM-Germany Article no.	NM-Germany Article no.	NM-Germany Article no.	
			<b>KBSRN40670G</b>	<b>KBRN40670G</b>	<b>KRRN40670G</b>			

RENAULT

ENGINE TYPE Motortyp Type de Moteur Tipo de motor Тип двигателя	LINER KIT Liner Kit Kit de Chemise Camisas de los cilindros лайнер комплект	CYL. LINER Zylinderlaufbuchse Chemise Camisas de los cilindros втулка цилиндра	PISTON + RINGS Kolben + Ringe Piston + Segments Pistón Set Поршень и кольца			PISTON SET Kolben Set Set de Piston Pistón Set поршневой	RINGS SET Kolben Set Segments de Piston Anillos Set кольца	PIN Pin Axe Perno Пин
<b>F3P 674/676/700</b> <b>F3P 720/754/755</b> <b>F3P 760/761/765</b> 4 Cyl 82.7 mm Bore Ø 1,783 cc 1,794 cc		Length: Outside Ø: Flange Ø: flange depth	Length: Comp: Height:	60.0 33.55 -2.98	skirt MOS2 treated	Top: 1.5	Ø: 21.0 Length: 65.0	
						2nd: 1.75		
						3rd: 3.0 1st oil: 2nd oil:		
	Reference no.:	Reference no.:	Reference no.:	Reference no.:	O-RING			
			<b>77 01 467 662</b> <b>A-R67580</b> <b>G-0833740000</b> <b>M-02162N0</b>	<b>K-94440600</b> <b>M-0216100</b>		<b>77 01 467 662</b> <b>A-R67580</b> <b>G-0833740000</b> <b>M-02162N0</b>		
NM-Germany Article no. Artikelnummer/ Modelo Número / статья НОМЕР	NM-Germany Article no.	NM-Germany Article no.	NM-Germany Article no.	NM-Germany Article no.	NM-Germany Article no.	NM-Germany Article no.	NM-Germany Article no.	
			<b>KBSRN40671G</b>	<b>KBRN40671G</b>	<b>KRRN40671G</b>			

**GASOLINE**

ENGINE TYPE Motortyp Type de Moteur Tipo de motor Тип двигателя	LINER KIT Liner Kit Kit de Chemise Camisas de los cilindros лайнер комплект	CYL. LINER Zylinderlaufbuchse Chemise Camisas de los cilindros втулка цилиндра	PISTON + RINGS Kolben + Ringe Piston + Segments Pistón Set Поршень и кольца			PISTON SET Kolben Set Set de Piston Pistón Set поршень	RINGS SET Kolben Set Segments de Piston Anillos Set кольца	PIN Pin Axe Perno Пин			
<b>F3R 200/728/729</b> <b>F3R 742/751/752</b> <b>F3R 768/769</b> 4 Cyl 82.7 mm Bore Ø 1,998 cc		Length: Outside Ø: Flange Ø: flange depth	Length: 66.5 Comp: 41.5 Height: -9.7			Top: 1.5 2nd: 1.75 3rd: 1st oil: 3.0 2nd oil:	Ø: 21.0 Length: 57.0				
						Reference no.:		Reference no.:	Reference no.:	Reference no.:	O-RING
								<b>K-94385600</b>		<b>77 01 467 662</b> <b>A-R67580</b> <b>G-0833740000</b> <b>M-02162N0</b>	
NM-Germany Article no. Artikelnummer/ Modelo Número / статья НОМЕР	NM-Germany Article no.	NM-Germany Article no.	NM-Germany Article no.	NM-Germany Article no.	NM-Germany Article no.	NM-Germany Article no.	NM-Germany Article no.				
			<b>KBSRN40672G</b>	<b>KBRN40672G</b>	<b>KRRN40672G</b>						

**GASOLINE**

ENGINE TYPE Motortyp Type de Moteur Tipo de motor Тип двигателя	LINER KIT Liner Kit Kit de Chemise Camisas de los cilindros лайнер комплект	CYL. LINER Zylinderlaufbuchse Chemise Camisas de los cilindros втулка цилиндра	PISTON + RINGS Kolben + Ringe Piston + Segments Pistón Set Поршень и кольца			PISTON SET Kolben Set Set de Piston Pistón Set поршень	RINGS SET Kolben Set Segments de Piston Anillos Set кольца	PIN Pin Axe Perno Пин			
<b>F3R 611/722/723</b> <b>F3R 791/796/797</b> <b>F3R 798</b> 4 Cyl 82.7 mm Bore Ø 1,998 cc		Length: Outside Ø: Flange Ø: flange depth	Length: 60.0 Comp: 36.1 Height: -9.0		skirt MOS2 treated	Top: 1.5 2nd: 1.75 3rd: 1st oil: 3.0 2nd oil:	Ø: 21.0 Length: 57.0				
						Reference no.:		Reference no.:	Reference no.:	Reference no.:	O-RING
								<b>K-94442600</b> <b>M-0216200</b>	<b>77 01 680 806</b>	<b>77 01 467 662</b> <b>A-R67580</b> <b>G-0833740000</b> <b>M-02162N0</b>	
NM-Germany Article no. Artikelnummer/ Modelo Número / статья НОМЕР	NM-Germany Article no.	NM-Germany Article no.	NM-Germany Article no.	NM-Germany Article no.	NM-Germany Article no.	NM-Germany Article no.	NM-Germany Article no.				
			<b>KBSRN40673G</b>	<b>KBRN40673G</b>	<b>KRRN40673G</b>						

**GASOLINE**

ENGINE TYPE Motortyp Type de Moteur Tipo de motor Тип двигателя	LINER KIT Liner Kit Kit de Chemise Camisas de los cilindros лайнер комплект	CYL. LINER Zylinderlaufbuchse Chemise Camisas de los cilindros втулка цилиндра	PISTON + RINGS Kolben + Ringe Piston + Segments Pistón Set Поршень и кольца			PISTON SET Kolben Set Set de Piston Pistón Set поршень	RINGS SET Kolben Set Segments de Piston Anillos Set кольца	PIN Pin Axe Perno Пин			
<b>F4P 720/722/760</b> <b>F4P 770/771/772</b> <b>F4P 773/774/775</b> 4 Cyl 82.7 mm Bore Ø 1,783 cc		Length: Outside Ø: Flange Ø: flange depth	Length: 56.8 Comp: 29.75 Height: -1.0			Top: 1.2 2nd: 1.5 3rd: 1st oil: 2.0 2nd oil:	Ø: 21.0 Length: 61.0				
						Reference no.:		Reference no.:	Reference no.:	Reference no.:	O-RING
								<b>K-40021600</b> <b>M-0221000</b>		<b>77 01 474 725</b> <b>K-800074510000</b> <b>M-02210N0</b>	
NM-Germany Article no. Artikelnummer/ Modelo Número / статья НОМЕР	NM-Germany Article no.	NM-Germany Article no.	NM-Germany Article no.	NM-Germany Article no.	NM-Germany Article no.	NM-Germany Article no.	NM-Germany Article no.				
			<b>KBSRN40674G</b>	<b>KBRN40674G</b>	<b>KRRN40674G</b>						



## GASOLINE

ENGINE TYPE	LINER KIT	CYL. LINER	PISTON + RINGS			PISTON SET	RINGS SET	PIN
Motor typ Type de Moteur Tipo de motor Тип двигателя	Liner Kit Kit de Chemise Camisas de los cilindros лайнер комплект	Zylinderlaufbuchse Chemise Camisas de los cilindros втулка цилиндра	Kolben + Ringe Piston + Segments Pistón Set Поршень и кольца			Kolben Set Set de Piston Pistón Set поршневой	Kolben Set Segments de Piston Anillos Set кольца	Pin Axe Perno Пин
<b>F4R 720/730/740</b> <b>F4R 763/780/790</b> <b>F4R 794/795/797</b> 4 Cyl 82.7 mm Bore Ø 1,998 cc		Length:		Length:	56.75	Top:	1.2	Ø: 21.0 Length: 61.0
		Outside Ø:		Comp:	30.25	2nd:	1.5	
		Flange Ø:		Height:	-2.6	3rd:	2.0	
		flange depth				1st oil:	2.0	
			Reference no.:	Reference no.:	Reference no.:	Reference no.:	O-RING	
			<b>K-40355600</b>		<b>77 00 110 719</b>	<b>77 01 474 725</b> <b>K-800074510000</b> <b>M-02210N0</b>		
NM-Germany Article no. Artikelnummer/ Modelo Número / статья НОМЕР	NM-Germany Article no.	NM-Germany Article no.	NM-Germany Article no.	NM-Germany Article no.	NM-Germany Article no.	NM-Germany Article no.	NM-Germany Article no.	NM-Germany Article no.
			<b>KBSRN40675G</b>	<b>KBRN40675G</b>	<b>KRRN40675G</b>			

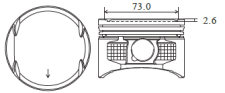

## DIESEL

ENGINE TYPE	LINER KIT	CYL. LINER	PISTON + RINGS			PISTON SET	RINGS SET	PIN	
Motor typ Type de Moteur Tipo de motor Тип двигателя	Liner Kit Kit de Chemise Camisas de los cilindros лайнер комплект	Zylinderlaufbuchse Chemise Camisas de los cilindros втулка цилиндра	Kolben + Ringe Piston + Segments Pistón Set Поршень и кольца			Kolben Set Set de Piston Pistón Set поршневой	Kolben Set Segments de Piston Anillos Set кольца	Pin Axe Perno Пин	
<b>M9R 740</b> <b>M9R 780</b> 4 Cyl 84.0 mm Bore Ø 1,995 cc	<b>K-40262600</b> <b>N-8742200000</b> <b>G-0842200000</b> <b>K-800057140000</b>	Length:	169.5	Length:	76.0	alfin and with oil gallery skirt MOS2 treated fits tapered con. rod	Top:	2.5	Ø: 32.0 Length: 65.0
		Outside Ø:	88.0	Comp:	47.92		2nd:	2.0	
		Flange Ø:	91.0	Height:	-5.3		3rd:	2.0	
		flange depth	5.0		-14.9	1st oil:	2.0		
			Reference no.:	Reference no.:	Reference no.:	Reference no.:	O-RING		
NM-Germany Article no. Artikelnummer/ Modelo Número / статья НОМЕР	NM-Germany Article no.	NM-Germany Article no.	NM-Germany Article no.	NM-Germany Article no.	NM-Germany Article no.	NM-Germany Article no.	NM-Germany Article no.	NM-Germany Article no.	
	<b>LBSRN40676DSB</b>	<b>LBRN40676DSB</b>	<b>KBSRN40676DB</b>	<b>KBRN40676DB</b>	<b>KRRN40676DB</b>				

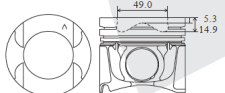



RENAULT

## DIESEL

ENGINE TYPE	LINER KIT	CYL. LINER	PISTON + RINGS			PISTON SET	RINGS SET	PIN
Motor typ Type de Moteur Tipo de motor Тип двигателя	Liner Kit Kit de Chemise Camisas de los cilindros лайнер комплект	Zylinderlaufbuchse Chemise Camisas de los cilindros втулка цилиндра	Kolben + Ringe Piston + Segments Pistón Set Поршень и кольца			Kolben Set Set de Piston Pistón Set поршневой	Kolben Set Segments de Piston Anillos Set кольца	Pin Axe Perno Пин
<b>M1D</b> 4 Cyl 84.0 mm Bore Ø 1,995 cc		Length:		Length:		alfin and with oil gallery	Top:	Ø:
		Outside Ø:		Comp:			2nd:	Length:
		Flange Ø:		Height:			3rd:	
		flange depth				1st oil:		
			Reference no.:	Reference no.:	Reference no.:	Reference no.:	O-RING	
NM-Germany Article no. Artikelnummer/ Modelo Número / статья НОМЕР	NM-Germany Article no.	NM-Germany Article no.	NM-Germany Article no.	NM-Germany Article no.	NM-Germany Article no.	NM-Germany Article no.	NM-Germany Article no.	NM-Germany Article no.
			<b>KBSRN40677DB</b>	<b>KBRN40677DB</b>				

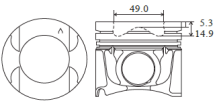

**DIESEL**

ENGINE TYPE Motortyp Type de Moteur Tipo de motor Тип двигателя	LINER KIT Liner Kit Kit de Chemise Camisas de los cilindros лайнер комплект	CYL. LINER Zylinderlaufbuchse Chemise Camisas de los cilindros втулка цилиндра	PISTON + RINGS Kolben + Ringe Piston + Segments Pistón Set Поршень и кольца		PISTON SET Kolben Set Set de Piston Pistón Set поршневой	RINGS SET Kolben Set Segments de Piston Anillos Set кольца	PIN Pin Axe Perno Пин		
<b>M9R 780</b> 4 Cyl 84.0 mm Bore Ø 1,995 cc 		Length:	169.5	Length:	76.0	alfin and with oil gallery skirt MOS2 treated fits tapered con. rod	Top:	2.5	Ø: 30.0 Length: 65.0
		Outside Ø:	88.0	Comp:	47.9		2nd:	2.0	
		Flange Ø:	91.0	Height:	-5.3		3rd:	2.0	
		flange depth	5.0		-14.9		1st oil:	2.0	
		Reference no.:		Reference no.:		Reference no.:		Reference no.:	O-RING
				<b>77 01 476 735</b>			<b>G-084220000 K-800057140000</b>		
NM-Germany Article no. Artikelnummer/ Modelo Número / статья НОМЕР	NM-Germany Article no.	NM-Germany Article no.	NM-Germany Article no.	NM-Germany Article no.	NM-Germany Article no.	NM-Germany Article no.	NM-Germany Article no.	NM-Germany Article no.	NM-Germany Article no.
	<b>LBSRN40678DSB</b>	<b>LBRN40678DSB</b>	<b>KBSRN40678DB</b>	<b>KBRN40678DB</b>	<b>KRRN40678DB</b>				

**DIESEL**

ENGINE TYPE Motortyp Type de Moteur Tipo de motor Тип двигателя	LINER KIT Liner Kit Kit de Chemise Camisas de los cilindros лайнер комплект	CYL. LINER Zylinderlaufbuchse Chemise Camisas de los cilindros втулка цилиндра	PISTON + RINGS Kolben + Ringe Piston + Segments Pistón Set Поршень и кольца		PISTON SET Kolben Set Set de Piston Pistón Set поршневой	RINGS SET Kolben Set Segments de Piston Anillos Set кольца	PIN Pin Axe Perno Пин		
<b>V9X</b> 6 Cyl 84.0 mm Bore Ø 2,993 cc		Length:		Length:		alfin and with oil gallery	Top:		Ø: Length:
		Outside Ø:		Comp:			2nd:		
		Flange Ø:		Height:			3rd:		
		flange depth					1st oil:		
		Reference no.:		Reference no.:		Reference no.:		Reference no.:	O-RING
NM-Germany Article no. Artikelnummer/ Modelo Número / статья НОМЕР	NM-Germany Article no.	NM-Germany Article no.	NM-Germany Article no.	NM-Germany Article no.	NM-Germany Article no.	NM-Germany Article no.	NM-Germany Article no.	NM-Germany Article no.	NM-Germany Article no.
			<b>KBSRN60679DB</b>	<b>KBRN60679DB</b>	<b>KRRN60679DB</b>				

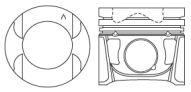
**DIESEL**

ENGINE TYPE Motortyp Type de Moteur Tipo de motor Тип двигателя	LINER KIT Liner Kit Kit de Chemise Camisas de los cilindros лайнер комплект	CYL. LINER Zylinderlaufbuchse Chemise Camisas de los cilindros втулка цилиндра	PISTON + RINGS Kolben + Ringe Piston + Segments Pistón Set Поршень и кольца		PISTON SET Kolben Set Set de Piston Pistón Set поршневой	RINGS SET Kolben Set Segments de Piston Anillos Set кольца	PIN Pin Axe Perno Пин		
<b>M9T 606/670/672/676 M9T 678/680/686/690 M9T 692/698/870/872 M9T 876/880</b> 4 Cyl 85.0 mm Bore Ø 2,298 cc 		Length:		Length:	76.0	alfin and with oil gallery fits tapered con. rod	Top:	2.5	Ø: 32.0 Length: 65.0
		Outside Ø:		Comp:	47.88		2nd:	2.0	
		Flange Ø:		Height:	-16.2		3rd:	2.0	
		flange depth					1st oil:	2.0	
		Reference no.:		Reference no.:		Reference no.:		Reference no.:	O-RING
				<b>K-97504600</b>		<b>K-800074810000</b>			
NM-Germany Article no. Artikelnummer/ Modelo Número / статья НОМЕР	NM-Germany Article no.	NM-Germany Article no.	NM-Germany Article no.	NM-Germany Article no.	NM-Germany Article no.	NM-Germany Article no.	NM-Germany Article no.	NM-Germany Article no.	NM-Germany Article no.
			<b>KBSRN40680DB</b>	<b>KBRN40680DB</b>	<b>KRRN40680DB</b>				

**DIESEL**

ENGINE TYPE Motortyp Type de Moteur Tipo de motor Тип двигателя	LINER KIT Liner Kit Kit de Chemise Camisas de los cilindros лайнер комплект	CYL. LINER Zylinderlaufbuchse Chemise Camisas de los cilindros втулка цилиндра	PISTON + RINGS Kolben + Ringe Piston + Segments Pistón Set Поршень и кольца			PISTON SET Kolben Set Set de Piston Pistón Set поршневой	RINGS SET Kolben Set Segments de Piston Anillos Set кольца	PIN Pin Axe Perno Пин		
<b>J8S</b> 4 Cyl 86.0 mm Bore Ø 2,068 cc	<b>A-ASA2525</b> <b>K-90436960</b> <b>M-0218492</b> <b>N-8933700000</b>	Length: 166.0 Outside Ø: 93.6 Flange Ø: collar depth 93.05	Length: 93.0 Comp: 51.0 Height: -4.0		alfin	Top: 2.5 double key-stone 2nd: 2.5 3rd: 1st oil: 4.0 2nd oil:	Ø: 28.0 Length: 75.0			
						Reference no.:	Reference no.:	Reference no.:	Reference no.:	O-RING
						<b>A-SJ351473</b> <b>G-1400032000</b> <b>K-89309110</b> <b>M-021WN29</b>	<b>K-90436600</b> <b>M-0218400</b>		<b>A-R66430</b> <b>G-0833700000</b> <b>K-800023540000</b> <b>M-02184N0</b>	<b>ORRN40681DA</b>
NM-Germany Article no. Artikelnummer/ Modelo Número / статья НОМЕР	NM-Germany Article no.	NM-Germany Article no.	NM-Germany Article no.	NM-Germany Article no.	NM-Germany Article no.	NM-Germany Article no.	NM-Germany Article no.			
	LBSRN40681DFA	LBRN40681DFA	KBSRN40681DA	KBRN40681DA	KRRN40681DA					

**DIESEL**



ENGINE TYPE Motortyp Type de Moteur Tipo de motor Тип двигателя	LINER KIT Liner Kit Kit de Chemise Camisas de los cilindros лайнер комплект	CYL. LINER Zylinderlaufbuchse Chemise Camisas de los cilindros втулка цилиндра	PISTON + RINGS Kolben + Ringe Piston + Segments Pistón Set Поршень и кольца			PISTON SET Kolben Set Set de Piston Pistón Set поршневой	RINGS SET Kolben Set Segments de Piston Anillos Set кольца	PIN Pin Axe Perno Пин		
<b>G8T 706/752</b> <b>G8T 790/792/794</b> 4 Cyl 87.0 mm Bore Ø 2,188 cc		Length: 160.0 Outside Ø: 91.55 Flange Ø: 92.5 flange depth 4.0	Length: 75.0 Comp: 45.0 Height: -3.0		alfin	Top: 2.5 2nd: 1.75 3rd: 1st oil: 2.5 2nd oil:	Ø: 28.0 Length: 68.5			
						Reference no.:	Reference no.:	Reference no.:	Reference no.:	O-RING
							<b>A-A350543</b> <b>K-94743700</b> <b>M-0215000</b> <b>N-8710160000</b>		<b>A-R60390</b> <b>G-0810160000</b> <b>M-02165V0</b>	
NM-Germany Article no. Artikelnummer/ Modelo Número / статья НОМЕР	NM-Germany Article no.	NM-Germany Article no.	NM-Germany Article no.	NM-Germany Article no.	NM-Germany Article no.	NM-Germany Article no.	NM-Germany Article no.			
	LBSRN40682DSA	LBRN40682DSA	KBSRN40682DA	KBRN40682DA	KRRN40682DA					

RENAULT



**DIESEL**

ENGINE TYPE Motortyp Type de Moteur Tipo de motor Тип двигателя	LINER KIT Liner Kit Kit de Chemise Camisas de los cilindros лайнер комплект	CYL. LINER Zylinderlaufbuchse Chemise Camisas de los cilindros втулка цилиндра	PISTON + RINGS Kolben + Ringe Piston + Segments Pistón Set Поршень и кольца			PISTON SET Kolben Set Set de Piston Pistón Set поршневой	RINGS SET Kolben Set Segments de Piston Anillos Set кольца	PIN Pin Axe Perno Пин		
<b>G8T 714/716</b> <b>G8T 740/760</b> 4 Cyl 87.0 mm Bore Ø 2,188 cc		Length: 160.0 Outside Ø: 91.55 Flange Ø: 92.5 flange depth 4.0	Length: 80.0 Comp: 44.78 Height: -2.9		alfin and with oil gallery head anodized skirt MOS2 treated	Top: 3.0 2nd: 1.75 3rd: 1st oil: 2.5 2nd oil:	Ø: 31.0 Length: 71.0			
						Reference no.:	Reference no.:	Reference no.:	Reference no.:	O-RING
							<b>K-94816600</b> <b>M-0215400</b>	<b>77 01 469 223</b> <b>77 01 469 224</b>	<b>77 01 470 570</b> <b>A-R60640</b> <b>G-0811880000</b> <b>K-800053140000</b> <b>M-02154N0</b>	
NM-Germany Article no. Artikelnummer/ Modelo Número / статья НОМЕР	NM-Germany Article no.	NM-Germany Article no.	NM-Germany Article no.	NM-Germany Article no.	NM-Germany Article no.	NM-Germany Article no.	NM-Germany Article no.			
	LBSRN40683DSB	LBRN40683DSB	KBSRN40683DB	KBRN40683DB	KRRN40683DB					

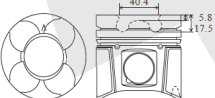

## DIESEL

ENGINE TYPE Motortyp Type de Moteur Tipo de motor Тип двигателя	LINER KIT Liner Kit Kit de Chemise Camisas de los cilindros лайнер комплект	CYL. LINER Zylinderlaufbuchse Chemise Camisas de los cilindros втулка цилиндра	PISTON + RINGS Kolben + Ringe Piston + Segments Pistón Set Поршень и кольца		PISTON SET Kolben Set Set de Piston Pistón Set поршневой	RINGS SET Kolben Set Segments de Piston Anillos Set кольца	PIN Pin Axe Perno Пин		
<b>G9T 710/720</b> <b>G9T 722/750</b> 4 Cyl 87.0 mm Bore Ø 2,188 cc 		Length:	162.0	Length:	84.2	alfin skirt MOS2 treated fits tapered con. rod	Top:	3.0	Ø: 31.0 Length: 65.0
		Outside Ø:	91.05	Comp:	54.53		half keystone		
		Flange Ø:	92.5	Height:	-5.8		2nd:	1.75	
		flange depth	4.0		-17.5		3rd:	2.5	
			Reference no.:	Reference no.:	Reference no.:	Reference no.:	O-RING		
				<b>K-99469600</b> <b>N-8712740000</b>		<b>77 01 474 973</b> <b>A-R66780</b> <b>G-0812740000</b> <b>K-800051040000</b> <b>M-02207N0</b>			
NM-Germany Article no. Artikelnummer/ Modelo Número / статья НОМЕР	NM-Germany Article no.	NM-Germany Article no.	NM-Germany Article no.	NM-Germany Article no.	NM-Germany Article no.	NM-Germany Article no.	NM-Germany Article no.		
	<b>LBSRN40684DSA</b>	<b>LBRN40684DSA</b>	<b>KBSRN40684DA</b>	<b>KBRN40684DA</b>	<b>KRRN40684DA</b>				

## DIESEL

ENGINE TYPE Motortyp Type de Moteur Tipo de motor Тип двигателя	LINER KIT Liner Kit Kit de Chemise Camisas de los cilindros лайнер комплект	CYL. LINER Zylinderlaufbuchse Chemise Camisas de los cilindros втулка цилиндра	PISTON + RINGS Kolben + Ringe Piston + Segments Pistón Set Поршень и кольца		PISTON SET Kolben Set Set de Piston Pistón Set поршневой	RINGS SET Kolben Set Segments de Piston Anillos Set кольца	PIN Pin Axe Perno Пин		
<b>G9T 700/702/703/704</b> <b>G9T 706/707/708/709</b> <b>G9T 712/742/743/744</b> 4 Cyl 87.0 mm Bore Ø 2,188 cc 		Length:	162.0	Length:	84.2	alfin and with oil gallery skirt MOS2 treated fits tapered con. rod	Top:	3.0	Ø: 31.0 Length: 65.0
		Outside Ø:	91.05	Comp:	54.53		half keystone		
		Flange Ø:	92.5	Height:	-5.8		2nd:	1.75	
		flange depth	4.0		-17.5		3rd:	2.5	
			Reference no.:	Reference no.:	Reference no.:	Reference no.:	O-RING		
				<b>K-99433600</b>		<b>77 01 474 973</b> <b>A-R66780</b> <b>G-0812740000</b> <b>K-800051040000</b> <b>M-02207N0</b>			
NM-Germany Article no. Artikelnummer/ Modelo Número / статья НОМЕР	NM-Germany Article no.	NM-Germany Article no.	NM-Germany Article no.	NM-Germany Article no.	NM-Germany Article no.	NM-Germany Article no.	NM-Germany Article no.		
	<b>LBSRN40685DSB</b>	<b>LBRN40685DSB</b>	<b>KBSRN40685DB</b>	<b>KBRN40685DB</b>	<b>KRRN40685DB</b>				

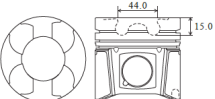
## DIESEL

ENGINE TYPE Motortyp Type de Moteur Tipo de motor Тип двигателя	LINER KIT Liner Kit Kit de Chemise Camisas de los cilindros лайнер комплект	CYL. LINER Zylinderlaufbuchse Chemise Camisas de los cilindros втулка цилиндра	PISTON + RINGS Kolben + Ringe Piston + Segments Pistón Set Поршень и кольца		PISTON SET Kolben Set Set de Piston Pistón Set поршневой	RINGS SET Kolben Set Segments de Piston Anillos Set кольца	PIN Pin Axe Perno Пин		
<b>G9T 600</b> 4 Cyl 87.0 mm Bore Ø 2,188 cc 		Length:	162.0	Length:	84.2	alfin and with oil gallery skirt MOS2 treated fits tapered con. rod	Top:	3.0	Ø: 31.0 Length: 65.0
		Outside Ø:	91.05	Comp:	54.53		half keystone		
		Flange Ø:	92.5	Height:	-15.0		2nd:	1.75	
		flange depth	4.0				3rd:	2.5	
			Reference no.:	Reference no.:	Reference no.:	Reference no.:	O-RING		
				<b>K-99551600</b>		<b>77 01 474 973</b> <b>A-R66780</b> <b>G-0812740000</b> <b>K-800051040000</b> <b>M-02207N0</b>			
NM-Germany Article no. Artikelnummer/ Modelo Número / статья НОМЕР	NM-Germany Article no.	NM-Germany Article no.	NM-Germany Article no.	NM-Germany Article no.	NM-Germany Article no.	NM-Germany Article no.	NM-Germany Article no.		
	<b>LBSRN40686DSB</b>	<b>LBRN40686DSB</b>	<b>KBSRN40686DB</b>	<b>KBRN40686DB</b>	<b>KRRN40686DB</b>				

## DIESEL

ENGINE TYPE	LINER KIT	CYL. LINER	PISTON + RINGS			PISTON SET	RINGS SET	PIN	
Motor typ Type de Moteur Tipo de motor Тип двигателя	Liner Kit Kit de Chemise Camisas de los cilindros лайнер комплект	Zylinderlaufbuchse Chemise Camisas de los cilindros втулка цилиндра	Kolben + Ringe Piston + Segments Pistón Set Поршень и кольца			Kolben Set Set de Piston Pistón Set поршневой	Kolben Set Segments de Piston Anillos Set кольца	Pin Axe Perno Пин	
<b>P9X 701</b> <b>P9X 715</b> 6 Cyl 87.5 mm Bore Ø 2,958 cc		Length:		Length:	72.4	alfin and with oil gallery skirt MOS2 treated	Top:	2.5	Ø: 28.5 Length: 70.0
		Outside Ø:		Comp:	44.1		2nd:	1.5	
		Flange Ø:		Height:	-5.0		3rd:	3.0	
		flange depth			-15.2		1st oil:		
			Reference no.:	Reference no.:		Reference no.:	Reference no.:	O-RING	
NM-Germany Article no. Artikelnummer/ Modelo Número / статья НОМЕР	NM-Germany Article no.	NM-Germany Article no.	NM-Germany Article no.	NM-Germany Article no.	NM-Germany Article no.	NM-Germany Article no.	NM-Germany Article no.	NM-Germany Article no.	
			KBSRN60687DB	KBRN60687DB (for cyl RH)		KRRN60687D			

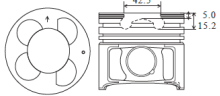

## DIESEL

ENGINE TYPE	LINER KIT	CYL. LINER	PISTON + RINGS			PISTON SET	RINGS SET	PIN	
Motor typ Type de Moteur Tipo de motor Тип двигателя	Liner Kit Kit de Chemise Camisas de los cilindros лайнер комплект	Zylinderlaufbuchse Chemise Camisas de los cilindros втулка цилиндра	Kolben + Ringe Piston + Segments Pistón Set Поршень и кольца			Kolben Set Set de Piston Pistón Set поршневой	Kolben Set Segments de Piston Anillos Set кольца	Pin Axe Perno Пин	
<b>P9X 701</b> <b>P9X 715</b> 6 Cyl 87.5 mm Bore Ø 2,958 cc		Length:		Length:	72.4	alfin and with oil gallery skirt MOS2 treated	Top:	2.5	Ø: 28.5 Length: 70.0
		Outside Ø:		Comp:	44.1		2nd:	1.5	
		Flange Ø:		Height:	-5.0		3rd:	3.0	
		flange depth			-15.2		1st oil:		
			Reference no.:	Reference no.:		Reference no.:	Reference no.:	O-RING	
NM-Germany Article no. Artikelnummer/ Modelo Número / статья НОМЕР	NM-Germany Article no.	NM-Germany Article no.	NM-Germany Article no.	NM-Germany Article no.	NM-Germany Article no.	NM-Germany Article no.	NM-Germany Article no.	NM-Germany Article no.	
			KBSRN60688DB	KBRN60688DB (for cyl LH)		KRRN60688D			

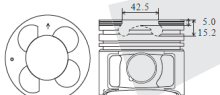



## GASOLINE

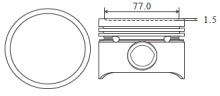

ENGINE TYPE	LINER KIT	CYL. LINER	PISTON + RINGS			PISTON SET	RINGS SET	PIN	
Motor typ Type de Moteur Tipo de motor Тип двигателя	Liner Kit Kit de Chemise Camisas de los cilindros лайнер комплект	Zylinderlaufbuchse Chemise Camisas de los cilindros втулка цилиндра	Kolben + Ringe Piston + Segments Pistón Set Поршень и кольца			Kolben Set Set de Piston Pistón Set поршневой	Kolben Set Segments de Piston Anillos Set кольца	Pin Axe Perno Пин	
<b>J5R J6R J7R</b> 4 Cyl 88.0 mm Bore Ø 1,995 cc	A-SA2511	Length:	140.0	Length:	65.5		Top:	1.75	Ø: 23.0 Length: 74.0
		Outside Ø:	93.55	Comp:	40.5		2nd:	2.0	
		Flange Ø:	104.2	Height:	-1.5		3rd:	4.0	
		collar depth	93.08				1st oil:		
			Reference no.:	Reference no.:	Reference no.:	Reference no.:	Reference no.:	O-RING	
			K-89086110 M-021WN24				A-R66300 G-0833440000 K-800003940000 M-03943N0	ORRN40689G	
NM-Germany Article no. Artikelnummer/ Modelo Número / статья НОМЕР	NM-Germany Article no.	NM-Germany Article no.	NM-Germany Article no.	NM-Germany Article no.	NM-Germany Article no.	NM-Germany Article no.	NM-Germany Article no.	NM-Germany Article no.	
	LBSRN40689GF	LBRN40689GF	KBSRN40689G	KBRN40689G		KRRN40689G			





**GASOLINE**

ENGINE TYPE Motortyp Type de Moteur Tipo de motor Тип двигателя	LINER KIT Liner Kit Kit de Chemise Camisas de los cilindros лайнер комплект	CYL. LINER Zylinderlaufbuchse Chemise Camisas de los cilindros втулка цилиндра	PISTON + RINGS Kolben + Ringe Piston + Segments Pistón Set Поршень и кольца	PISTON SET Kolben Set Set de Piston Pistón Set поршень	RINGS SET Kolben Set Segments de Piston Anillos Set кольца	PIN Pin Axe Perno Пин
<b>144.01</b> <b>6 Cyl</b> <b>88.0 mm Bore Ø</b> <b>2,664 cc</b>	<b>M-0395590</b>	Length: 131.9 Outside Ø: 93.5 Flange Ø: 102.2 collar depth 99.13	Length: 63.3 Comp: 38.45 Height: 1.1		Top: 1.5 2nd: 2.0 3rd: 4.0 1st oil: 4.0 2nd oil:	Ø: 23.5 Length: 72.0
		Reference no.:	Reference no.:	Reference no.:	Reference no.:	O-RING
		<b>M-039WN14</b>	<b>K-92875600</b> <b>M-0395500</b>		<b>A-R66110</b> <b>G-0831690000</b> <b>K-800003841000</b> <b>M-03953N0</b> <b>T-50023</b>	
NM-Germany Article no. Artikelnummer/ Modelo Número / статья НОМЕР	NM-Germany Article no.	NM-Germany Article no.	NM-Germany Article no.	NM-Germany Article no.	NM-Germany Article no.	NM-Germany Article no.
	<b>LBSRN60690GF</b>	<b>LBRN60690GF</b>	<b>KBSRN60690G</b>	<b>KBRN60690G</b>	<b>KRRN60690G</b>	<b>ORRN60690G</b>

**GASOLINE**

ENGINE TYPE Motortyp Type de Moteur Tipo de motor Тип двигателя	LINER KIT Liner Kit Kit de Chemise Camisas de los cilindros лайнер комплект	CYL. LINER Zylinderlaufbuchse Chemise Camisas de los cilindros втулка цилиндра	PISTON + RINGS Kolben + Ringe Piston + Segments Pistón Set Поршень и кольца	PISTON SET Kolben Set Set de Piston Pistón Set поршень	RINGS SET Kolben Set Segments de Piston Anillos Set кольца	PIN Pin Axe Perno Пин
<b>J7T</b> <b>4 Cyl</b> <b>88.0 mm Bore Ø</b> <b>2,165 cc</b>		Length: 148.5 Outside Ø: 93.6 Flange Ø: 104.0 collar depth 93.0	Length: 65.5 Comp: 40.5 Height: -4.6 -5.6		Top: 1.75 2nd: 2.0 3rd: 4.0 1st oil: 4.0 2nd oil:	Ø: 23.0 Length: 75.0
		Reference no.:	Reference no.:	Reference no.:	Reference no.:	O-RING
		<b>K-89334110</b> <b>M-039WN25</b>			<b>A-R66300</b> <b>G-0833440000</b> <b>K-800003940000</b> <b>M-03943N0</b>	<b>ORRN40691G</b>
NM-Germany Article no. Artikelnummer/ Modelo Número / статья НОМЕР	NM-Germany Article no.	NM-Germany Article no.	NM-Germany Article no.	NM-Germany Article no.	NM-Germany Article no.	NM-Germany Article no.
	<b>LBSRN40691GF</b>	<b>LBRN40691GF</b>	<b>KBSRN40691G</b>	<b>KBRN40691G</b>	<b>KRRN40691G</b>	

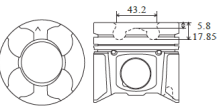
**DIESEL**

ENGINE TYPE Motortyp Type de Moteur Tipo de motor Тип двигателя	LINER KIT Liner Kit Kit de Chemise Camisas de los cilindros лайнер комплект	CYL. LINER Zylinderlaufbuchse Chemise Camisas de los cilindros втулка цилиндра	PISTON + RINGS Kolben + Ringe Piston + Segments Pistón Set Поршень и кольца	PISTON SET Kolben Set Set de Piston Pistón Set поршень	RINGS SET Kolben Set Segments de Piston Anillos Set кольца	PIN Pin Axe Perno Пин
<b>G9U 720/724</b> <b>G9U 730/736</b> <b>G9U 750/754</b> <b>4 Cyl</b> <b>89.0 mm Bore Ø</b> <b>2,463 cc</b>	<b>superseded by</b> <b>LBSRN40693DSA</b>	Length: 167.0 Outside Ø: 92.5 Flange Ø: 94.0 flange depth 4.0	Length: 83.09 Comp: 53.03 Height: -5.8 -17.85	alfin skirt MOS2 treated fits tapered con. rod	Top: 3.0 half keystone 2nd: 1.75 3rd: 2.5 1st oil: 2.5 2nd oil:	Ø: 31.0 Length: 65.0
		Reference no.:	Reference no.:	Reference no.:	Reference no.:	O-RING
			<b>superseded by</b> <b>KBSRN40693DA</b>	<b>superseded by</b> <b>KBRN40693DA</b>	<b>A-R66720</b> <b>G-0813750000</b> <b>K-800053240000</b> <b>K-800059040000</b> <b>M-02213N0</b>	
NM-Germany Article no. Artikelnummer/ Modelo Número / статья НОМЕР	NM-Germany Article no.	NM-Germany Article no.	NM-Germany Article no.	NM-Germany Article no.	NM-Germany Article no.	NM-Germany Article no.
	<b>LBSRN40692DA</b>	<b>LBRN40692DA</b>	<b>KBSRN40692D</b>	<b>KBRN40692D</b>	<b>KRRN40692D</b>	

**DIESEL**

ENGINE TYPE Motortyp Type de Moteur Tipo de motor Тип двигателя	LINER KIT Liner Kit Kit de Chemise Camisas de los cilindros лайнер комплект	CYL. LINER Zylinderlaufbuchse Chemise Camisas de los cilindros втулка цилиндра	PISTON + RINGS Kolben + Ringe Piston + Segments Pistón Set Поршень и кольца			PISTON SET Kolben Set Set de Piston Pistón Set поршневой	RINGS SET Kolben Set Segments de Piston Anillos Set кольца	PIN Pin Axe Perno Пин
<b>G9U 720/724</b> <b>G9U 730/736</b> <b>G9U 750/754</b> 4 Cyl 89.0 mm Bore Ø 2,463 cc		Length: 167.0	Length: 83.09		alfin skirt MOS2 treated fits tapered con. rod	Top: 2.5	Ø: 31.0 Length: 65.0	
		Outside Ø: 92.5	Comp: 53.03			2nd: 1.75		
		Flange Ø: 94.0	Height: -5.8			3rd: 2.5		
flange depth 4.0		-17.58			1st oil: 2.5	2nd oil:		
		<b>Reference no.:</b>	<b>Reference no.:</b>	<b>Reference no.:</b>	<b>Reference no.:</b>	<b>O-RING</b>		
			<b>K-40079600</b> <b>M-0222600</b> <b>N-8713750010</b>		<b>G-0813750010</b> <b>K-800050640000</b>			
NM-Germany Article no. Artikelnummer/ Modelo Número / статья НОМЕР	NM-Germany Article no.	NM-Germany Article no.	NM-Germany Article no.	NM-Germany Article no.	NM-Germany Article no.	NM-Germany Article no.	NM-Germany Article no.	
	LBSRN40693DSA	LBRN40693DSA	KBSRN40693DA	KBRN40693DA	KRRN40693DA			

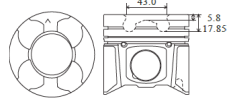

**DIESEL**

ENGINE TYPE Motortyp Type de Moteur Tipo de motor Тип двигателя	LINER KIT Liner Kit Kit de Chemise Camisas de los cilindros лайнер комплект	CYL. LINER Zylinderlaufbuchse Chemise Camisas de los cilindros втулка цилиндра	PISTON + RINGS Kolben + Ringe Piston + Segments Pistón Set Поршень и кольца			PISTON SET Kolben Set Set de Piston Pistón Set поршневой	RINGS SET Kolben Set Segments de Piston Anillos Set кольца	PIN Pin Axe Perno Пин
<b>G9U 650</b> 4 Cyl 89.0 mm Bore Ø 2,463 cc		Length: 167.0	Length: 83.09		alfin skirt MOS2 treated fits tapered con. rod	Top: 3.0	Ø: 31.0 Length: 65.0	
		Outside Ø: 92.5	Comp: 53.03			half keystone		
		Flange Ø: 94.0	Height: -4.9			2nd: 1.75		
flange depth 4.0		-16.1			3rd: 2.5	1st oil: 2.5	2nd oil:	
		<b>Reference no.:</b>	<b>Reference no.:</b>	<b>Reference no.:</b>	<b>Reference no.:</b>	<b>O-RING</b>		
			<b>K-40271600</b>		<b>A-R66720</b> <b>G-0813750000</b> <b>K-800053240000</b> <b>K-800059040000</b> <b>M-02213N0</b>			
NM-Germany Article no. Artikelnummer/ Modelo Número / статья НОМЕР	NM-Germany Article no.	NM-Germany Article no.	NM-Germany Article no.	NM-Germany Article no.	NM-Germany Article no.	NM-Germany Article no.	NM-Germany Article no.	
	LBSRN40694DSA	LBRN40694DSA	KBSRN40694DA	KBRN40694DA	KRRN40694DA			

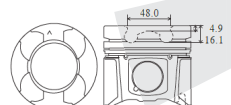



RENAULT

**DIESEL**

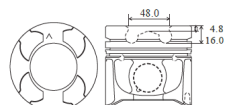
ENGINE TYPE Motortyp Type de Moteur Tipo de motor Тип двигателя	LINER KIT Liner Kit Kit de Chemise Camisas de los cilindros лайнер комплект	CYL. LINER Zylinderlaufbuchse Chemise Camisas de los cilindros втулка цилиндра	PISTON + RINGS Kolben + Ringe Piston + Segments Pistón Set Поршень и кольца			PISTON SET Kolben Set Set de Piston Pistón Set поршневой	RINGS SET Kolben Set Segments de Piston Anillos Set кольца	PIN Pin Axe Perno Пин
<b>G9U 630</b> 4 Cyl 89.0 mm Bore Ø 2,463 cc		Length: 167.0	Length: 83.1		alfin and with oil gallery skirt MOS2 treated fits tapered con. rod	Top: 3.0	Ø: 31.0 Length: 68.0	
		Outside Ø: 92.5	Comp: 53.1			half keystone		
		Flange Ø: 94.0	Height: -4.8			2nd: 1.75		
flange depth 4.0		-16.0			3rd: 2.5	1st oil: 2.5	2nd oil:	
		<b>Reference no.:</b>	<b>Reference no.:</b>	<b>Reference no.:</b>	<b>Reference no.:</b>	<b>O-RING</b>		
			<b>K-40272600</b>		<b>A-R66720</b> <b>G-0813750000</b> <b>K-800053240000</b> <b>K-800059040000</b> <b>M-02213N0</b>			
NM-Germany Article no. Artikelnummer/ Modelo Número / статья НОМЕР	NM-Germany Article no.	NM-Germany Article no.	NM-Germany Article no.	NM-Germany Article no.	NM-Germany Article no.	NM-Germany Article no.	NM-Germany Article no.	
	LBSRN40695DSB	LBRN40695DSB	KBSRN40695DB	KBRN40695DB	KRRN40695DB			



							<b>DIESEL</b>	
ENGINE TYPE Motortyp Type de Moteur Tipo de motor Тип двигателя	LINER KIT Liner Kit Kit de Chemise Camisas de los cilindros лайнер комплект	CYL. LINER Zylinderlaufbuchse Chemise Camisas de los cilindros втулка цилиндра	PISTON + RINGS Kolben + Ringe Piston + Segments Pistón Set Поршень и кольца		PISTON SET Kolben Set Set de Piston Pistón Set поршень	RINGS SET Kolben Set Segments de Piston Anillos Set кольца	PIN Pin Axe Perno Пин	
<b>8140.67</b> <b>4 Cyl</b> <b>93.0 mm Bore Ø</b> <b>2,499 cc</b>	<b>M-0070490</b>	Length: 171.0 Outside Ø: 96.0 Flange Ø: 98.9 flange depth 5.0	Length: 96.8 Comp: 58.8 Height: -13.1 -17.8		alfin	Top: 3.0 double key- stone 2nd: 2.0 3rd: 2.0 1st oil: 3.0 2nd oil:	Ø: 32.0 Length: 74.0	
		<b>Reference no.:</b>	<b>Reference no.:</b>	<b>Reference no.:</b>	<b>Reference no.:</b>	<b>O-RING</b>		
		<b>K-89319190</b> <b>M-007WV46</b>	<b>K-94327700</b> <b>M-0070400</b>			<b>A-R47080</b> <b>G-0824520000</b> <b>K-800006840000</b> <b>M-00805V0</b>		
NM-Germany Article no. Artikelnummer/ Modelo Número / статья НОМЕР	NM-Germany Article no.	NM-Germany Article no.	NM-Germany Article no.	NM-Germany Article no.	NM-Germany Article no.	NM-Germany Article no.	NM-Germany Article no.	
	<b>LBSRN40696DSA</b>	<b>LBRN40696DSA</b>	<b>KBSRN40696DA</b>	<b>KBRN40696DA</b>	<b>KRRN40696DA</b>			

							<b>DIESEL</b>	
ENGINE TYPE Motortyp Type de Moteur Tipo de motor Тип двигателя	LINER KIT Liner Kit Kit de Chemise Camisas de los cilindros лайнер комплект	CYL. LINER Zylinderlaufbuchse Chemise Camisas de los cilindros втулка цилиндра	PISTON + RINGS Kolben + Ringe Piston + Segments Pistón Set Поршень и кольца		PISTON SET Kolben Set Set de Piston Pistón Set поршень	RINGS SET Kolben Set Segments de Piston Anillos Set кольца	PIN Pin Axe Perno Пин	
<b>8140.61</b> <b>8140 58U</b> <b>8 U 8140</b> <b>4 Cyl</b> <b>93.0 mm Bore Ø</b> <b>2,445 cc</b>	(A) <b>K-93911970</b> consists of (C)  (B) <b>K-93911971</b> <b>M-0079882</b> consists of (D)	(C) (D) Length: 167.0 167.3 Outside Ø: 96.0 96.0 Flange Ø: 98.9 98.9 flange depth 5.0	Length: 89.8 Comp: 54.7 Height: -2.0		alfin head anodized	Top: 3.0 2nd: 2.0 3rd: 2.0 1st oil: 4.0 2nd oil:	Ø: 32.0 Length: 74.4	
		<b>Reference no.:</b>	<b>Reference no.:</b>	<b>Reference no.:</b>	<b>Reference no.:</b>	<b>O-RING</b>		
		(C) <b>A-SU351407</b> <b>K-89066190</b> <b>M-007WV39</b> (D) <b>G-1402256000</b> <b>K-89183190</b> <b>M-007WV43</b>	<b>A-A350663</b> <b>K-93911700</b> <b>M-0079810</b> <b>N-8721450000</b>			<b>A-R47010</b> <b>G-0821450010</b> <b>K-800007040000</b> <b>M-00798V0</b>		
NM-Germany Article no. Artikelnummer/ Modelo Número / статья НОМЕР	NM-Germany Article no.	NM-Germany Article no.	NM-Germany Article no.	NM-Germany Article no.	NM-Germany Article no.	NM-Germany Article no.	NM-Germany Article no.	
	<b>LBSRN40697DPA</b> <b>LBSRN40697DSA</b>	<b>LBRN40697DPA(C)</b> <b>LBRN40697DSA(D)</b>	<b>KBSRN40697DA</b>	<b>KBRN40697DA</b>	<b>KRRN40697DA</b>			

							<b>DIESEL</b>	
ENGINE TYPE Motortyp Type de Moteur Tipo de motor Тип двигателя	LINER KIT Liner Kit Kit de Chemise Camisas de los cilindros лайнер комплект	CYL. LINER Zylinderlaufbuchse Chemise Camisas de los cilindros втулка цилиндра	PISTON + RINGS Kolben + Ringe Piston + Segments Pistón Set Поршень и кольца		PISTON SET Kolben Set Set de Piston Pistón Set поршень	RINGS SET Kolben Set Segments de Piston Anillos Set кольца	PIN Pin Axe Perno Пин	
<b>8140.21.200 TURBO</b> <b>8140.21.235 TURBO</b> <b>4 Cyl</b> <b>93.0 mm Bore Ø</b> <b>2,445 cc</b>	<b>K-93123960</b> <b>M-0080592</b>	Length: 171.0 Outside Ø: 96.0 Flange Ø: 98.9 flange depth 5.0	Length: 97.65 Comp: 59.65 Height: -5.8 -14.8		alfin	Top: 3.0 double keystone 2nd: 2.0 3rd: 2.0 1st oil: 3.0 2nd oil:	Ø: 32.0 Length: 75.2	
		<b>Reference no.:</b>	<b>Reference no.:</b>	<b>Reference no.:</b>	<b>Reference no.:</b>	<b>O-RING</b>		
		<b>A-SU351419</b> <b>K-89319190</b> <b>M-007WV46</b> <b>N-1402137100</b>	<b>A-A350671</b> <b>K-93123600</b> <b>M-0080500</b> <b>N-8724520030</b>			<b>A-R47080</b> <b>G-0824520000</b> <b>K-800006840000</b> <b>M-00805V0</b>		
NM-Germany Article no. Artikelnummer/ Modelo Número / статья НОМЕР	NM-Germany Article no.	NM-Germany Article no.	NM-Germany Article no.	NM-Germany Article no.	NM-Germany Article no.	NM-Germany Article no.	NM-Germany Article no.	
	<b>LBSRN40698DSA</b>	<b>LBRN40698DSA</b>	<b>KBSRN40698DA</b>	<b>KBRN40698DA</b>	<b>KRRN40698DA</b>			



**DIESEL**

ENGINE TYPE Motortyp Type de Moteur Tipo de motor Тип двигателя	LINER KIT Liner Kit Kit de Chemise Camisas de los cilindros лайнер комплект	CYL. LINER Zylinderlaufbuchse Chemise Camisas de los cilindros втулка цилиндра	PISTON + RINGS Kolben + Ringe Piston + Segments Pistón Set Поршень и кольца	PISTON SET Kolben Set Set de Piston Pistón Set поршневой	RINGS SET Kolben Set Segments de Piston Anillos Set кольца	PIN Pin Axe Perno Пин						
<b>8140.47.2711 TURBO</b> <b>SU9.714 TURBO</b>  4 Cyl 93.0 mm Bore Ø 2,499 cc	<b>K-94382960</b> <b>M-0090790</b>	Length: 171.0 Outside Ø: 96.0 Flange Ø: 98.9 flange depth 5.0	Length: 96.75 Comp: 58.75 Height: -14.0 -18.4	alfin and with oil gallery skirt MOS2 treated pin bushing inserted	Top: 3.0 double keystone 2nd: 2.0 3rd: 1st oil: 3.0 2nd oil:	Ø: 32.0  Length: 78.1						
		Reference no.:			Reference no.:		Reference no.:		Reference no.:		O-RING	
		<b>A-SU351419</b> <b>K-89319190</b> <b>M-007WV46</b> <b>N-1402137100</b>			<b>A-A350510</b> <b>K-94382600</b> <b>M-0090700</b>		<b>A-R47080</b> <b>G-0824520000</b> <b>K-800006840000</b> <b>M-00805V0</b>					
NM-Germany Article no. Artikelnummer/ Modelo Número / статья НОМЕР	NM-Germany Article no.	NM-Germany Article no.	NM-Germany Article no.	NM-Germany Article no.	NM-Germany Article no.	NM-Germany Article no.						
	LBSRN40699DSB	LBRN40699DSB	KBSRN40699DB	KBRN40699DB	KRRN40699DB							

**DIESEL**



ENGINE TYPE Motortyp Type de Moteur Tipo de motor Тип двигателя	LINER KIT Liner Kit Kit de Chemise Camisas de los cilindros лайнер комплект	CYL. LINER Zylinderlaufbuchse Chemise Camisas de los cilindros втулка цилиндра	PISTON + RINGS Kolben + Ringe Piston + Segments Pistón Set Поршень и кольца	PISTON SET Kolben Set Set de Piston Pistón Set поршневой	RINGS SET Kolben Set Segments de Piston Anillos Set кольца	PIN Pin Axe Perno Пин						
<b>8140.23 TURBO</b> <b>8140.43 TURBO</b> <b>S9W 700/702 TURBO</b>  4 Cyl 94.4 mm Bore Ø 2,798 cc	<b>K-94701960</b> <b>M-0098990</b>	Length: 167.0 Outside Ø: 97.5 Flange Ø: 100.9 5.0	Length: 87.6 Comp: 58.8 Height: -15.1 -19.45	alfin and with oil gallery skirt MOS2 treated fits tapered con. rod	Top: 2.5 double keystone 2nd: 2.0 3rd: 1st oil: 2.5 2nd oil:	Ø: 32.0  Length: 72.0						
		Reference no.:			Reference no.:		Reference no.:		Reference no.:		O-RING	
		<b>G-1402839000</b> <b>K-89502190</b> <b>M-007WV56</b>			<b>A-A350582</b> <b>K-94701600</b> <b>M-0098900</b>		<b>A-R60070</b> <b>G-0812220000</b> <b>K-800038241000</b> <b>M-00990N0</b>					
NM-Germany Article no. Artikelnummer/ Modelo Número / статья НОМЕР	NM-Germany Article no.	NM-Germany Article no.	NM-Germany Article no.	NM-Germany Article no.	NM-Germany Article no.	NM-Germany Article no.						
	LBSRN40700DSB	LBRN40700DS	KBSRN40700D	KBRN40700DB	KRRN40700D							

RENAULT

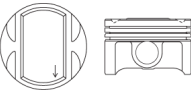

**DIESEL**

ENGINE TYPE Motortyp Type de Moteur Tipo de motor Тип двигателя	LINER KIT Liner Kit Kit de Chemise Camisas de los cilindros лайнер комплект	CYL. LINER Zylinderlaufbuchse Chemise Camisas de los cilindros втулка цилиндра	PISTON + RINGS Kolben + Ringe Piston + Segments Pistón Set Поршень и кольца	PISTON SET Kolben Set Set de Piston Pistón Set поршневой	RINGS SET Kolben Set Segments de Piston Anillos Set кольца	PIN Pin Axe Perno Пин						
<b>4.236</b>  4 Cyl 98.48 mm Bore Ø 3,864 cc	<b>K-93592962</b>	Length: 227.4 Outside Ø: 103.22 Flange Ø: 106.36 flange depth 3.8 +1.0	Length: 121.0 Comp: 70.3 Height: -20.5	alfin head anodized skirt MOS2 treated	Top: 2.385 2nd: 2.385 3rd: 1st oil: 4.747 2nd oil:	Ø: 34.93  Length: 84.0						
		Reference no.:			Reference no.:		Reference no.:		Reference no.:		O-RING	
		<b>K-88355190</b> <b>M-043WV12</b>			<b>K-93592600</b> <b>M-0433100</b>		<b>A-R34740</b> <b>G-0831890010</b> <b>K-800033710000</b> <b>M-04331N0</b>					
NM-Germany Article no. Artikelnummer/ Modelo Número / статья НОМЕР	NM-Germany Article no.	NM-Germany Article no.	NM-Germany Article no.	NM-Germany Article no.	NM-Germany Article no.	NM-Germany Article no.						
	LBSRN40701DSA	LBRN40701DS	KBSRN40701DA	KBRN40701DA	KRRN40701D							

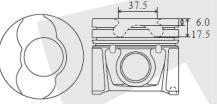

**GASOLINE**

ENGINE TYPE Motortyp Type de Moteur Tipo de motor Тип двигателя	LINER KIT Liner Kit Kit de Chemise Camisas de los cilindros лайнер комплект	CYL. LINER Zylinderlaufbuchse Chemise Camisas de los cilindros втулка цилиндра	PISTON + RINGS Kolben + Ringe Piston + Segments Pistón Set Поршень и кольца	PISTON SET Kolben Set Set de Piston Pistón Set поршень	RINGS SET Kolben Set Segments de Piston Anillos Set кольца	PIN Pin Axe Perno Пин
<b>B 258 I</b> 6 Cyl 81.6 mm Bore Ø 2,498 cc		Length: 51.08 Comp: 30.45 Height: 0.6			Top: 1.5 2nd: 1.5 3rd: 1.5 1st oil: 3.0 2nd oil:	Ø: 21.0 Length: 56.0
			<b>A-24090</b> <b>K-94954600</b> <b>M-0120600</b> <b>N-8730770000</b>		<b>A-R49600</b> <b>G-0830770000</b> <b>K-800040320000</b> <b>K-800040340000</b> <b>M-01170N0</b>	
NM-Germany Article no. Artikelnummer/ Modelo Número / статья НОМЕР	NM-Germany Article no.	NM-Germany Article no.	NM-Germany Article no.	NM-Germany Article no.	NM-Germany Article no.	NM-Germany Article no.
			<b>KBSSA60702G</b>	<b>KBSA60702G</b>	<b>KRSA60702G</b>	

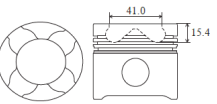

**DIESEL**

ENGINE TYPE Motortyp Type de Moteur Tipo de motor Тип двигателя	LINER KIT Liner Kit Kit de Chemise Camisas de los cilindros лайнер комплект	CYL. LINER Zylinderlaufbuchse Chemise Camisas de los cilindros втулка цилиндра	PISTON + RINGS Kolben + Ringe Piston + Segments Pistón Set Поршень и кольца	PISTON SET Kolben Set Set de Piston Pistón Set поршень	RINGS SET Kolben Set Segments de Piston Anillos Set кольца	PIN Pin Axe Perno Пин
<b>Z 19 DT</b> <b>Z 19 DTL</b> 4 Cyl 82.0 mm Bore Ø 1,910 cc		Length: 155.0 Outside Ø: 85.0 Flange Ø: 88.0 flange depth 4.5	Length: 72.5 Comp: 46.5 Height: -6.0 -17.5	alfin skirt MOS2 treated pin bushing inserted	Top: 2.0 2nd: 2.0 3rd: 2.0 1st oil: 2.0 2nd oil:	Ø: 25.988 Length: 61.0
			<b>A-A354067</b> <b>K-40218600</b> <b>K-99724600</b> <b>M-0101500</b> <b>N-8712400030</b>		<b>A-R60580</b> <b>A-R67925</b> <b>G-0812400000</b> <b>G-0814610000</b> <b>K-800072610000</b> <b>K-800073040000</b> <b>M-00981N0</b>	
NM-Germany Article no. Artikelnummer/ Modelo Número / статья НОМЕР	NM-Germany Article no.	NM-Germany Article no.	NM-Germany Article no.	NM-Germany Article no.	NM-Germany Article no.	NM-Germany Article no.
	<b>LBSSA40703DSA</b>	<b>LBSA40703DSA</b>	<b>KBSSA40703DA</b>	<b>KBSA40703DA</b>	<b>KRSA40703DA</b>	

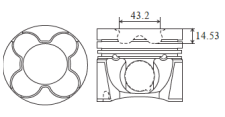

**DIESEL**

ENGINE TYPE Motortyp Type de Moteur Tipo de motor Тип двигателя	LINER KIT Liner Kit Kit de Chemise Camisas de los cilindros лайнер комплект	CYL. LINER Zylinderlaufbuchse Chemise Camisas de los cilindros втулка цилиндра	PISTON + RINGS Kolben + Ringe Piston + Segments Pistón Set Поршень и кольца	PISTON SET Kolben Set Set de Piston Pistón Set поршень	RINGS SET Kolben Set Segments de Piston Anillos Set кольца	PIN Pin Axe Perno Пин
<b>Z 19 DTH</b> <b>Z 19 DTJ</b> 4 Cyl 82.0 mm Bore Ø 1,910 cc		Length: 155.0 Outside Ø: 85.0 Flange Ø: 88.0 flange depth 4.5	Length: 73.5 Comp: 46.5 Height: -0.7 -15.4	alfin and with oil gallery skirt MOS2 treated pin bushing inserted	Top: 2.0 2nd: 2.0 3rd: 2.0 1st oil: 2.0 2nd oil:	Ø: 26.0 Length: 61.0
			<b>A-A354086</b> <b>K-40660600</b> <b>M-0101600</b> <b>N-8714610000</b>		<b>A-R60580</b> <b>A-R67925</b> <b>G-0812400000</b> <b>G-0814610000</b> <b>K-800072610000</b> <b>K-800073040000</b> <b>M-00981N0</b>	
NM-Germany Article no. Artikelnummer/ Modelo Número / статья НОМЕР	NM-Germany Article no.	NM-Germany Article no.	NM-Germany Article no.	NM-Germany Article no.	NM-Germany Article no.	NM-Germany Article no.
	<b>LBSSA40704DSB</b>	<b>LBSA40704DSB</b>	<b>KBSSA40704DB</b>	<b>KBSA40704DB</b>	<b>KRSA40704DB</b>	

**DIESEL**

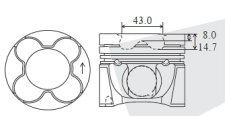

ENGINE TYPE	LINER KIT	CYL. LINER	PISTON + RINGS			PISTON SET	RINGS SET	PIN
Motor typ Type de Moteur Tipo de motor Тип двигателя	Liner Kit Kit de Chemise Camisas de los cilindros лайнер комплект	Zylinderlaufbuchse Chemise Camisas de los cilindros втулка цилиндра	Kolben + Ringe Piston + Segments Pistón Set Поршень и кольца			Kolben Set Set de Piston Pistón Set поршень	Kolben Set Segments de Piston Anillos Set кольца	Pin Axe Perno Пин
<b>X 22 DTH</b> 4 Cyl 84.0 mm Bore Ø 2,172 cc		Length: Outside Ø: Flange Ø: flange depth	Length: 70.8 Comp: 45.8 Height: -14.53			alfin skirt MOS2 treated fits tapered con. rod	Top: 2.5 2nd: 1.75 3rd: 1st oil: 3.0 2nd oil:	Ø: 29.0 Length: 68.0
			Reference no.:	Reference no.:	Reference no.:	Reference no.:	O-RING	
			<b>M-0120300</b>			<b>M-01203N0</b>		
NM-Germany Article no. Artikelnummer/ Modelo Número / статья НОМЕР	NM-Germany Article no.	NM-Germany Article no.	NM-Germany Article no.	NM-Germany Article no.	NM-Germany Article no.	NM-Germany Article no.	NM-Germany Article no.	
			<b>KBSSA40705DA</b>	<b>KBSA40705DA</b>	<b>KRSA40705DA</b>			

**DIESEL**

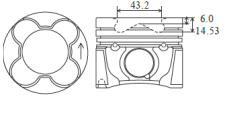

ENGINE TYPE	LINER KIT	CYL. LINER	PISTON + RINGS			PISTON SET	RINGS SET	PIN
Motor typ Type de Moteur Tipo de motor Тип двигателя	Liner Kit Kit de Chemise Camisas de los cilindros лайнер комплект	Zylinderlaufbuchse Chemise Camisas de los cilindros втулка цилиндра	Kolben + Ringe Piston + Segments Pistón Set Поршень и кольца			Kolben Set Set de Piston Pistón Set поршень	Kolben Set Segments de Piston Anillos Set кольца	Pin Axe Perno Пин
<b>Y 22 DTR</b> 4 Cyl 84.0 mm Bore Ø 2,172 cc		Length: Outside Ø: Flange Ø: flange depth	Length: 70.8 Comp: 45.85 Height: -8.0			alfin and with oil gallery skirt MOS2 treated fits tapered con. rod	Top: 1.75 2nd: 1.75 3rd: 1st oil: 3.0 2nd oil:	Ø: 29.0 Length: 68.0
			Reference no.:	Reference no.:	Reference no.:	Reference no.:	O-RING	
			<b>A-A350600</b> <b>M-0120900</b> <b>N-8712600010</b>			<b>A-R60610</b> <b>G-0812600000</b> <b>M-01208N0</b>		
NM-Germany Article no. Artikelnummer/ Modelo Número / статья НОМЕР	NM-Germany Article no.	NM-Germany Article no.	NM-Germany Article no.	NM-Germany Article no.	NM-Germany Article no.	NM-Germany Article no.	NM-Germany Article no.	
			<b>KBSSA40706DB</b>	<b>KBSA40706DB</b>	<b>KRSA40706DB</b>			

SAAB

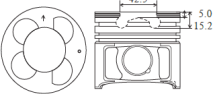

**DIESEL**

ENGINE TYPE	LINER KIT	CYL. LINER	PISTON + RINGS			PISTON SET	RINGS SET	PIN
Motor typ Type de Moteur Tipo de motor Тип двигателя	Liner Kit Kit de Chemise Camisas de los cilindros лайнер комплект	Zylinderlaufbuchse Chemise Camisas de los cilindros втулка цилиндра	Kolben + Ringe Piston + Segments Pistón Set Поршень и кольца			Kolben Set Set de Piston Pistón Set поршень	Kolben Set Segments de Piston Anillos Set кольца	Pin Axe Perno Пин
<b>Y 22 DTH</b> 4 Cyl 84.0 mm Bore Ø 2,171 cc		Length: Outside Ø: Flange Ø: flange depth	Length: 70.8 Comp: 45.8 Height: -6.0			alfin and with oil gallery skirt MOS2 treated	Top: 1.75 2nd: 1.75 3rd: 1st oil: 3.0 2nd oil:	Ø: 29.0 Length: 68.0
			Reference no.:	Reference no.:	Reference no.:	Reference no.:	O-RING	
			<b>M-0121700</b>			<b>A-R60610</b> <b>G-0812600000</b> <b>M-01208N0</b>		
NM-Germany Article no. Artikelnummer/ Modelo Número / статья НОМЕР	NM-Germany Article no.	NM-Germany Article no.	NM-Germany Article no.	NM-Germany Article no.	NM-Germany Article no.	NM-Germany Article no.	NM-Germany Article no.	
			<b>KBSSA40707DB</b>	<b>KBSA40707DB</b>	<b>KRSA40707DB</b>			

## DIESEL

ENGINE TYPE	LINER KIT	CYL. LINER	PISTON + RINGS	PISTON SET	RINGS SET	PIN
Motor typ Type de Moteur Tipo de motor Тип двигателя	Liner Kit Kit de Chemise Camisas de los cilindros лайнер комплект	Zylinderlaufbuchse Chemise Camisas de los cilindros втулка цилиндра	Kolben + Ringe Piston + Segments Pistón Set Поршень и кольца	Kolben Set Set de Piston Pistón Set поршневой	Kolben Set Segments de Piston Anillos Set кольца	Pin Axe Perno Пин
<b>D 308 L</b> 6 Cyl 87.5 mm Bore Ø 2,958 cc		Length: Outside Ø: Flange Ø: flange depth	Length: 72.4 Comp: 44.1 Height: -5.0 -15.2	alfin and with oil gallery skirt MOS2 treated	Top: 2.5 2nd: 1.5 3rd: 3.0 1st oil: 2nd oil:	Ø: 28.5 Length: 70.0
						
NM-Germany Article no. Artikelnummer/ Modelo Número / статья НОМЕР	NM-Germany Article no.	NM-Germany Article no.	NM-Germany Article no.	NM-Germany Article no.	NM-Germany Article no.	NM-Germany Article no.
			<b>KBSSA60708DB</b>	<b>KBSA60708DB</b> (for cyl RH)	<b>KRSA60708DB</b>	

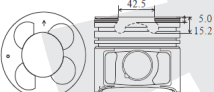
## DIESEL

ENGINE TYPE	LINER KIT	CYL. LINER	PISTON + RINGS	PISTON SET	RINGS SET	PIN
Motor typ Type de Moteur Tipo de motor Тип двигателя	Liner Kit Kit de Chemise Camisas de los cilindros лайнер комплект	Zylinderlaufbuchse Chemise Camisas de los cilindros втулка цилиндра	Kolben + Ringe Piston + Segments Pistón Set Поршень и кольца	Kolben Set Set de Piston Pistón Set поршневой	Kolben Set Segments de Piston Anillos Set кольца	Pin Axe Perno Пин
<b>D 308 L</b> 6 Cyl 87.5 mm Bore Ø 2,958 cc		Length: Outside Ø: Flange Ø: flange depth	Length: 72.4 Comp: 44.1 Height: -5.0 -15.2	alfin and with oil gallery skirt MOS2 treated	Top: 2.5 2nd: 1.5 3rd: 3.0 1st oil: 2nd oil:	Ø: 28.5 Length: 70.0
						
NM-Germany Article no. Artikelnummer/ Modelo Número / статья НОМЕР	NM-Germany Article no.	NM-Germany Article no.	NM-Germany Article no.	NM-Germany Article no.	NM-Germany Article no.	NM-Germany Article no.
			<b>KBSSA60709DB</b>	<b>KBSA60709DB</b> (for cyl LH)	<b>KRSA60709DB</b>	

**GASOLINE**

ENGINE TYPE Motortyp Type de Moteur Tipo de motor Тип двигателя	LINER KIT Liner Kit Kit de Chemise Camisas de los cilindros лайнер комплект	CYL. LINER Zylinderlaufbuchse Chemise Camisas de los cilindros штулка цилиндра	PISTON + RINGS Kolben + Ringe Piston + Segments Pistón Set Поршень и кольца		PISTON SET Kolben Set Set de Piston Pistón Set поршневой	RINGS SET Kolben Set Segments de Piston Anillos Set кольца	PIN Pin Axe Perno Пин	
<b>0.8 NCA 100 GL 1000 GL</b> 4 Cyl 65.0 mm Bore Ø 843 cc 903 cc		Length: Outside Ø: Flange Ø: flange depth	Length:	61.2		Top:	1.75	Ø: 20.0 Length: 54.0
			Comp:	30.7		2nd:	2.0	
			Height:	0		3rd:	3.94	
		Reference no.:	Reference no.:	Reference no.:	Reference no.:	O-RING		
			<b>A-24165 K-90451700 M-0072000 N-8720980000</b>		<b>A-R46550 G-0820980000 K-800005641000 M-00720N0</b>			
NM-Germany Article no. Artikelnummer/ Modelo Número / статья НОМЕР	NM-Germany Article no.	NM-Germany Article no.	NM-Germany Article no.	NM-Germany Article no.	NM-Germany Article no.	NM-Germany Article no.	NM-Germany Article no.	
			<b>KBSST40712G</b>	<b>KBST40712G</b>	<b>KRST40712G</b>			



**GASOLINE**

ENGINE TYPE Motortyp Type de Moteur Tipo de motor Тип двигателя	LINER KIT Liner Kit Kit de Chemise Camisas de los cilindros лайнер комплект	CYL. LINER Zylinderlaufbuchse Chemise Camisas de los cilindros штулка цилиндра	PISTON + RINGS Kolben + Ringe Piston + Segments Pistón Set Поршень и кольца		PISTON SET Kolben Set Set de Piston Pistón Set поршневой	RINGS SET Kolben Set Segments de Piston Anillos Set кольца	PIN Pin Axe Perno Пин	
<b>100 GL6</b> 4 Cyl 65.0 mm Bore Ø 843 cc		Length: Outside Ø: Flange Ø: flange depth	Length:	63.0		Top:	1.75	Ø: 20.0 Length: 55.0
			Comp:	32.5		2nd:	2.0	
			Height:	0		3rd:	3.94	
		Reference no.:	Reference no.:	Reference no.:	Reference no.:	O-RING		
			<b>K-92914600 M-0072200</b>		<b>A-R46550 G-0820980000 K-800005641000 M-00720N0</b>			
NM-Germany Article no. Artikelnummer/ Modelo Número / статья НОМЕР	NM-Germany Article no.	NM-Germany Article no.	NM-Germany Article no.	NM-Germany Article no.	NM-Germany Article no.	NM-Germany Article no.	NM-Germany Article no.	
			<b>KBSST40713G</b>	<b>KBST40713G</b>	<b>KRST40713G</b>			

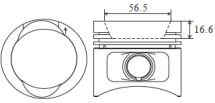

**GASOLINE**

ENGINE TYPE Motortyp Type de Moteur Tipo de motor Тип двигателя	LINER KIT Liner Kit Kit de Chemise Camisas de los cilindros лайнер комплект	CYL. LINER Zylinderlaufbuchse Chemise Camisas de los cilindros штулка цилиндра	PISTON + RINGS Kolben + Ringe Piston + Segments Pistón Set Поршень и кольца		PISTON SET Kolben Set Set de Piston Pistón Set поршневой	RINGS SET Kolben Set Segments de Piston Anillos Set кольца	PIN Pin Axe Perno Пин			
<b>AER ALL</b> 4 Cyl 67.1 mm Bore Ø 999 cc		Length: Outside Ø: Flange Ø: flange depth	Length:	56.3	STD	O/S		Top:	1.0	Ø: 17.0 Length: 45.0
			Comp:	31.3	31.05	2nd:		1.2		
			Height:	-5.7	-5.7	3rd:		2.0		
		Reference no.:	Reference no.:	Reference no.:	Reference no.:	O-RING				
			<b>K-99679600 M-0305200 N-8710130000</b>		<b>A-R66690 G-0810130000 K-800053740000 M-03052N0</b>					
NM-Germany Article no. Artikelnummer/ Modelo Número / статья НОМЕР	NM-Germany Article no.	NM-Germany Article no.	NM-Germany Article no.	NM-Germany Article no.	NM-Germany Article no.	NM-Germany Article no.	NM-Germany Article no.			
			<b>KBSST40714G</b>	<b>KBST40714G</b>	<b>KRST40714G</b>					

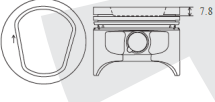

**GASOLINE**

ENGINE TYPE Motortyp Type de Moteur Tipo de motor Тип двигателя	LINER KIT Liner Kit Kit de Chemise Camisas de los cilindros лайнер комплект	CYL. LINER Zylinderlaufbuchse Chemise Camisas de los cilindros втулка цилиндра	PISTON + RINGS Kolben + Ringe Piston + Segments Pistón Set Поршень и кольца		PISTON SET Kolben Set Set de Piston Pistón Set поршневой	RINGS SET Kolben Set Segments de Piston Anillos Set кольца	PIN Pin Axe Perno Пин	
<b>2G AAV</b> 4 Cyl 75.0 mm Bore Ø 1,272 cc 	<b>M-0297390</b>	Length:	133.0	Length:	STD	O/S	Top: 1.75 2nd: 2.0 3rd: 1st oil: 3.0 2nd oil:	Ø: 20.0 Length: 54.0
		Outside Ø:	78.0	Comp:	69.87	69.62		
		Flange Ø:	81.0	Height:	42.87	42.62		
		flange depth	4.5		-16.6	-16.6		
			<b>Reference no.:</b>	<b>Reference no.:</b>	<b>Reference no.:</b>	<b>Reference no.:</b>	<b>O-RING</b>	
			<b>M-029WV19</b>	<b>K-93896600</b> <b>M-0297300</b>		<b>G-0840620000</b> <b>K-800025040000</b> <b>M-02952N0</b>		
NM-Germany Article no. Artikelnummer/ Modelo Número / статья HOMEP	NM-Germany Article no.	NM-Germany Article no.	NM-Germany Article no.	NM-Germany Article no.	NM-Germany Article no.	NM-Germany Article no.	NM-Germany Article no.	
	<b>LBSST40715GS</b>	<b>LBST40715GS</b>	<b>KBSST40715G</b>	<b>KBST40715G</b>	<b>KRST40715G</b>			



**GASOLINE**

ENGINE TYPE Motortyp Type de Moteur Tipo de motor Тип двигателя	LINER KIT Liner Kit Kit de Chemise Camisas de los cilindros лайнер комплект	CYL. LINER Zylinderlaufbuchse Chemise Camisas de los cilindros втулка цилиндра	PISTON + RINGS Kolben + Ringe Piston + Segments Pistón Set Поршень и кольца		PISTON SET Kolben Set Set de Piston Pistón Set поршневой	RINGS SET Kolben Set Segments de Piston Anillos Set кольца	PIN Pin Axe Perno Пин	
<b>AEE ALM</b> 4 Cyl 76.5 mm Bore Ø 1,598 cc 		Length:		Length:	STD	O/S	Top: 1.2 2nd: 1.5 3rd: 1st oil: 2.5 2nd oil:	Ø: 17.0 Length: 52.0
		Outside Ø:		Comp:	60.2	60.0		
		Flange Ø:		Height:	30.9	30.65		
		flange depth			-7.8	-7.8		
			<b>Reference no.:</b>	<b>Reference no.:</b>	<b>Reference no.:</b>	<b>Reference no.:</b>	<b>O-RING</b>	
				<b>K-94553600</b> <b>M-0304200</b> <b>N-8750280010</b>		<b>A-R60280</b> <b>G-0850280000</b> <b>K-800026140000</b> <b>M-03032N0</b>		
NM-Germany Article no. Artikelnummer/ Modelo Número / статья HOMEP	NM-Germany Article no.	NM-Germany Article no.	NM-Germany Article no.	NM-Germany Article no.	NM-Germany Article no.	NM-Germany Article no.	NM-Germany Article no.	
			<b>KBSST40716G</b>	<b>KBST40716G</b>	<b>KRST40716G</b>			

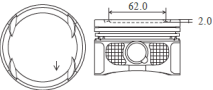

**GASOLINE**

ENGINE TYPE Motortyp Type de Moteur Tipo de motor Тип двигателя	LINER KIT Liner Kit Kit de Chemise Camisas de los cilindros лайнер комплект	CYL. LINER Zylinderlaufbuchse Chemise Camisas de los cilindros втулка цилиндра	PISTON + RINGS Kolben + Ringe Piston + Segments Pistón Set Поршень и кольца		PISTON SET Kolben Set Set de Piston Pistón Set поршневой	RINGS SET Kolben Set Segments de Piston Anillos Set кольца	PIN Pin Axe Perno Пин	
<b>AKK ANW AUD</b> 4 Cyl 76.5 mm Bore Ø 1,390 cc 		Length:		Length:			Top: 1.2 2nd: 1.5 3rd: 1st oil: 2.5 2nd oil:	Ø: 17.0 Length: 52.0
		Outside Ø:		Comp:	48.5			
		Flange Ø:		Height:	28.5	-5.4		
		flange depth						
			<b>Reference no.:</b>	<b>Reference no.:</b>	<b>Reference no.:</b>	<b>Reference no.:</b>	<b>O-RING</b>	
				<b>K-94773600</b> <b>M-0306300</b>		<b>A-R60280</b> <b>G-0850280000</b> <b>K-800026140000</b> <b>M-03032N0</b>		
NM-Germany Article no. Artikelnummer/ Modelo Número / статья HOMEP	NM-Germany Article no.	NM-Germany Article no.	NM-Germany Article no.	NM-Germany Article no.	NM-Germany Article no.	NM-Germany Article no.	NM-Germany Article no.	
			<b>KBSST40717G</b>	<b>KBST40717G</b>	<b>KRST40717G</b>			

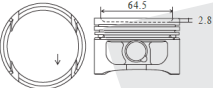

**GASOLINE**

ENGINE TYPE Motortyp Type de Moteur Tipo de motor Тип двигателя	LINER KIT Liner Kit Kit de Chemise Camisas de los cilindros лайнер комплект	CYL. LINER Zylinderlaufbuchse Chemise Camisas de los cilindros втулка цилиндра	PISTON + RINGS Kolben + Ringe Piston + Segments Pistón Set Поршень и кольца		PISTON SET Kolben Set Set de Piston Pistón Set поршневой	RINGS SET Kolben Set Segments de Piston Anillos Set кольца	PIN Pin Axe Perno Пин
<b>AFH/AFK/AHW APE/AUA/AXP</b> 4 Cyl 76.5 mm Bore Ø 1,390 cc 		Length: Outside Ø: Flange Ø: flange depth	STD	O/S	skirt MOS2 treated	Top: 1.2	Ø: 17.0 Length: 54.0
			Length: 50.0	49.75		2nd: 1.5	
			Comp: 29.0	28.75		3rd: 2.5	
		Height: -2.0	-2.0	1st oil: 2.5	2nd oil:		
		flange depth	-2.3	-2.3			
		Reference no.:	Reference no.:	Reference no.:	Reference no.:	O-RING	
			<b>K-99562600 M-0306100 N-8711610000</b>		<b>A-R60280 G-0850280000 K-800026140000 M-03032N0</b>		
NM-Germany Article no. Artikelnummer/ Modelo Número / статья НОМЕР	NM-Germany Article no.	NM-Germany Article no.	NM-Germany Article no.	NM-Germany Article no.	NM-Germany Article no.	NM-Germany Article no.	
			<b>KBSST40718G</b>	<b>KBST40718G</b>	<b>KRST40718G</b>		

**GASOLINE**

ENGINE TYPE Motortyp Type de Moteur Tipo de motor Тип двигателя	LINER KIT Liner Kit Kit de Chemise Camisas de los cilindros лайнер комплект	CYL. LINER Zylinderlaufbuchse Chemise Camisas de los cilindros втулка цилиндра	PISTON + RINGS Kolben + Ringe Piston + Segments Pistón Set Поршень и кольца		PISTON SET Kolben Set Set de Piston Pistón Set поршневой	RINGS SET Kolben Set Segments de Piston Anillos Set кольца	PIN Pin Axe Perno Пин
<b>ATN AZD</b> 4 Cyl 76.5 mm Bore Ø 1,598 cc 		Length: Outside Ø: Flange Ø: flange depth	STD	O/S	skirt MOS2 treated	Top: 1.2	Ø: 17.0 Length: 54.0
			Length: 50.2	50.0		2nd: 1.5	
			Comp: 29.2	29.0		3rd: 2.5	
		Height: -2.8	-2.6	1st oil: 2.5	2nd oil:		
		flange depth					
		Reference no.:	Reference no.:	Reference no.:	Reference no.:	O-RING	
			<b>K-94958600 K-99563600</b>		<b>A-R60280 G-0850280000 K-800026140000 M-03032N0</b>		
NM-Germany Article no. Artikelnummer/ Modelo Número / статья НОМЕР	NM-Germany Article no.	NM-Germany Article no.	NM-Germany Article no.	NM-Germany Article no.	NM-Germany Article no.	NM-Germany Article no.	
			<b>KBSST40719G</b>	<b>KBST40719G</b>	<b>KRST40719G</b>		

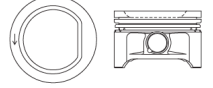
**GASOLINE**

ENGINE TYPE Motortyp Type de Moteur Tipo de motor Тип двигателя	LINER KIT Liner Kit Kit de Chemise Camisas de los cilindros лайнер комплект	CYL. LINER Zylinderlaufbuchse Chemise Camisas de los cilindros втулка цилиндра	PISTON + RINGS Kolben + Ringe Piston + Segments Pistón Set Поршень и кольца		PISTON SET Kolben Set Set de Piston Pistón Set поршневой	RINGS SET Kolben Set Segments de Piston Anillos Set кольца	PIN Pin Axe Perno Пин
<b>AEX/AKV ANX/ APQ</b> 4 Cyl 76.5 mm Bore Ø 1,389 cc 		Length: Outside Ø: Flange Ø: flange depth	STD	0.50 0.25 0.75	skirt MOS2 treated pin boss gap=20.2mm	Top: 1.2	Ø: 17.0 Length: 52.0
			Length: 50.35	50.1		2nd: 1.5	
			Comp: 28.35	28.1		3rd: 2.5	
		Height: -5.95	-5.7	1st oil: 2.5	2nd oil:		
		flange depth					
		Reference no.:	Reference no.:	Reference no.:	Reference no.:	O-RING	
			<b>M-0303200 N-8750280000</b>		<b>A-R60280 G-0850280000 K-800026140000 M-03032N0</b>		
NM-Germany Article no. Artikelnummer/ Modelo Número / статья НОМЕР	NM-Germany Article no.	NM-Germany Article no.	NM-Germany Article no.	NM-Germany Article no.	NM-Germany Article no.	NM-Germany Article no.	
			<b>KBSST40720G</b>	<b>KBST40720G</b>	<b>KRST40720G</b>		

							DIESEL					
ENGINE TYPE Motortyp Type de Moteur Tipo de motor Тип двигателя	LINER KIT Liner Kit Kit de Chemise Camisas de los cilindros лайнер комплект	CYL. LINER Zylinderlaufbuchse Chemise Camisas de los cilindros втулка цилиндра	PISTON + RINGS Kolben + Ringe Piston + Segments Pistón Set Поршень и кольца		PISTON SET Kolben Set Set de Piston Pistón Set поршневой	RINGS SET Kolben Set Segments de Piston Anillos Set кольца	PIN Pin Axe Perno Пин					
<b>1Z/AFN/AGR TURBO</b> <b>AHF/ALH/ASV TURBO</b>  <b>4 Cyl</b> <b>79.5 mm Bore Ø</b> <b>1,896 cc</b>	<b>K-94427970</b>	Length: 152.0 Outside Ø: 82.5 Flange Ø: 85.5 flange depth 4.7	Length: 71.8 Comp: 45.8 Height: -8.8 -17.75	STD 0.50 0.25 1.00 71.8 45.55 -8.8 -17.75	alfin top ring land and skirt MOS2 treated pin bushing inserted	Top: 1.75 2nd: 2.0 3rd: 3.0 1st oil: 2nd oil:	Ø: 26.0  Length: 66.0					
								Reference no.:	Reference no.:	Reference no.:	Reference no.:	O-RING
								<b>A-SU351317</b> <b>G-1402795000</b> <b>K-89434190</b> <b>M-029WV20</b>	<b>K-94427700</b> <b>M-0304000</b> <b>N-8711490095</b>		<b>A-R60370</b> <b>G-0811490000</b> <b>K-80000810000</b> <b>K-800051640000</b> <b>M-03020N0</b>	
NM-Germany Article no. Artikelnummer/ Modelo Número / статья НОМЕР	NM-Germany Article no.	NM-Germany Article no.	NM-Germany Article no.	NM-Germany Article no.	NM-Germany Article no.	NM-Germany Article no.						
	<b>LBSST40721DSA</b> (for cyl 1/2)	<b>LBST40721DSA</b>	<b>KBSST40721DA</b> (for cyl 1/2)	<b>KBST40721DA</b> (for cyl 1/2)	<b>KRST40721DA</b>							

							DIESEL					
ENGINE TYPE Motortyp Type de Moteur Tipo de motor Тип двигателя	LINER KIT Liner Kit Kit de Chemise Camisas de los cilindros лайнер комплект	CYL. LINER Zylinderlaufbuchse Chemise Camisas de los cilindros втулка цилиндра	PISTON + RINGS Kolben + Ringe Piston + Segments Pistón Set Поршень и кольца		PISTON SET Kolben Set Set de Piston Pistón Set поршневой	RINGS SET Kolben Set Segments de Piston Anillos Set кольца	PIN Pin Axe Perno Пин					
<b>1Z/AFN/AGR TURBO</b> <b>AHF/ALH/ASV TURBO</b>  <b>4 Cyl</b> <b>79.5 mm Bore Ø</b> <b>1,896 cc</b>	<b>K-94428970</b>	Length: 152.0 Outside Ø: 82.5 Flange Ø: 85.5 flange depth 4.7	Length: 71.8 Comp: 45.8 Height: -8.8 -17.75	STD 0.50 0.25 1.00 71.8 45.55 -8.8 -17.75	alfin top ring land and skirt MOS2 treated pin bushing inserted	Top: 1.75 2nd: 2.0 3rd: 3.0 1st oil: 2nd oil:	Ø: 26.0  Length: 66.0					
								Reference no.:	Reference no.:	Reference no.:	Reference no.:	O-RING
								<b>A-SU351317</b> <b>G-1402795000</b> <b>K-89434190</b> <b>M-029WV20</b>	<b>K-94428700</b> <b>M-0304100</b> <b>N-8711490090</b>		<b>A-R60370</b> <b>G-0811490000</b> <b>K-80000810000</b> <b>K-800051640000</b> <b>M-03020N0</b>	
NM-Germany Article no. Artikelnummer/ Modelo Número / статья НОМЕР	NM-Germany Article no.	NM-Germany Article no.	NM-Germany Article no.	NM-Germany Article no.	NM-Germany Article no.	NM-Germany Article no.						
	<b>LBSST40722DSA</b> (for cyl 3/4)	<b>LBST40722DSA</b>	<b>KBSST40722DA</b> (for cyl 3/4)	<b>KBST40722DA</b> (for cyl 3/4)	<b>KRST40722DA</b>							

							DIESEL					
ENGINE TYPE Motortyp Type de Moteur Tipo de motor Тип двигателя	LINER KIT Liner Kit Kit de Chemise Camisas de los cilindros лайнер комплект	CYL. LINER Zylinderlaufbuchse Chemise Camisas de los cilindros втулка цилиндра	PISTON + RINGS Kolben + Ringe Piston + Segments Pistón Set Поршень и кольца		PISTON SET Kolben Set Set de Piston Pistón Set поршневой	RINGS SET Kolben Set Segments de Piston Anillos Set кольца	PIN Pin Axe Perno Пин					
<b>1Y</b> <b>AEF</b>  <b>4 Cyl</b> <b>79.5 mm Bore Ø</b> <b>1,896 cc</b>	<b>K-91386960</b> <b>M-0298290</b>	Length: 152.0 Outside Ø: 82.5 Flange Ø: 85.5 flange depth 4.7	Length: 65.7 Comp: 39.65 Height: -1.9 -1.9	STD 0.50 0.25 1.00 65.7 39.4 -1.9 -1.9	alfin	Top: 1.75 2nd: 2.0 3rd: 3.0 1st oil: 2nd oil:	Ø: 24.0  Length: 64.0					
								Reference no.:	Reference no.:	Reference no.:	Reference no.:	O-RING
								<b>A-SU351317</b> <b>G-1402795000</b> <b>K-89434190</b> <b>M-029WV20</b>	<b>K-91386600</b> <b>M-0298200</b> <b>N-8799010040</b>		<b>A-R60370</b> <b>G-0811490000</b> <b>K-80000810000</b> <b>K-800051640000</b> <b>M-03020N0</b>	
NM-Germany Article no. Artikelnummer/ Modelo Número / статья НОМЕР	NM-Germany Article no.	NM-Germany Article no.	NM-Germany Article no.	NM-Germany Article no.	NM-Germany Article no.	NM-Germany Article no.						
	<b>LBSST40723DSA</b>	<b>LBST40723DSA</b>	<b>KBSST40723DA</b>	<b>KBST40723DA</b>	<b>KRST40723DA</b>							





**DIESEL**

ENGINE TYPE Motortyp Type de Moteur Tipo de motor Тип двигателя	LINER KIT Liner Kit Kit de Chemise Camisas de los cilindros лайнер комплект	CYL. LINER Zylinderlaufbuchse Chemise Camisas de los cilindros втулка цилиндра	PISTON + RINGS Kolben + Ringe Piston + Segments Pistón Set Поршень и кольца		PISTON SET Kolben Set Set de Piston Pistón Set поршневой	RINGS SET Kolben Set Segments de Piston Anillos Set кольца	PIN Pin Axe Perno Пин
<b>AAZ TURBO ABL TURBO</b> 4 Cyl 79.5 mm Bore Ø 1,896 cc	<b>K-91429960 M-0299690</b>	Length: 152.0 Outside Ø: 82.5 Flange Ø: 85.5 flange depth 4.7	STD	0.50	alfin head anodized skirt MOS2 treated	Top: 1.75 2nd: 2.0 3rd: 3.0 1st oil: 2nd oil:	Ø: 26.0 Length: 66.0
			0.25	1.00			
			Length: 71.65	71.65			
	<b>Reference no.:</b>	<b>Reference no.:</b>	<b>Reference no.:</b>	<b>Reference no.:</b>	<b>O-RING</b>		
	<b>A-SU351317 G-1402795000 K-89434190 M-029VV20</b>	<b>K-91429600 M-0299600 N-8799010010</b>			<b>A-R60370 G-0811490000 K-80000810000 K-800051640000 M-03020N0</b>		
NM-Germany Article no. Artikelnummer/ Modelo Número / статья НОМЕР	NM-Germany Article no.	NM-Germany Article no.	NM-Germany Article no.	NM-Germany Article no.	NM-Germany Article no.	NM-Germany Article no.	NM-Germany Article no.
	<b>LBSST40724DSA</b>	<b>LBST40724DSA</b>	<b>KBST40724DA</b>	<b>KBST40724DA</b>	<b>KRST40724DA</b>		

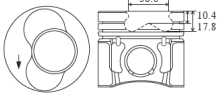

ENGINE TYPE Motortyp Type de Moteur Tipo de motor Тип двигателя	LINER KIT Liner Kit Kit de Chemise Camisas de los cilindros лайнер комплект	CYL. LINER Zylinderlaufbuchse Chemise Camisas de los cilindros втулка цилиндра	PISTON + RINGS Kolben + Ringe Piston + Segments Pistón Set Поршень и кольца		PISTON SET Kolben Set Set de Piston Pistón Set поршневой	RINGS SET Kolben Set Segments de Piston Anillos Set кольца	PIN Pin Axe Perno Пин
<b>ARL TURBO ASZ TURBO</b> 4 Cyl 79.5 mm Bore Ø 1,896 cc		Length: 152.0 Outside Ø: 82.5 Flange Ø: 85.5 flange depth 4.7	STD	O/S	alfin and with oil gallery skirt MOS2 treated pin bushing inserted fits tapered con. rod	Top: 1.75 2nd: 2.0 3rd: 3.0 1st oil: 2nd oil:	Ø: 26.0 Length: 66.0
			69.8	69.55			
			Length: 69.8	69.55			
	<b>Reference no.:</b>	<b>Reference no.:</b>	<b>Reference no.:</b>	<b>Reference no.:</b>	<b>O-RING</b>		
	<b>A-SU351317 G-1402795000 K-89434190 M-029VV20</b>	<b>K-99470600 M-0308600 N-8711490045</b>			<b>A-R60370 G-0811490000 K-80000810000 K-800051640000 M-03020N0</b>		
NM-Germany Article no. Artikelnummer/ Modelo Número / статья НОМЕР	NM-Germany Article no.	NM-Germany Article no.	NM-Germany Article no.	NM-Germany Article no.	NM-Germany Article no.	NM-Germany Article no.	NM-Germany Article no.
	<b>LBSST40725DSB (for cyl 1/2)</b>	<b>LBST40725DSB</b>	<b>KBST40725DB (for cyl 1/2)</b>	<b>KBST40725DB (for cyl 1/2)</b>	<b>KRST40725DB</b>		

ENGINE TYPE Motortyp Type de Moteur Tipo de motor Тип двигателя	LINER KIT Liner Kit Kit de Chemise Camisas de los cilindros лайнер комплект	CYL. LINER Zylinderlaufbuchse Chemise Camisas de los cilindros втулка цилиндра	PISTON + RINGS Kolben + Ringe Piston + Segments Pistón Set Поршень и кольца		PISTON SET Kolben Set Set de Piston Pistón Set поршневой	RINGS SET Kolben Set Segments de Piston Anillos Set кольца	PIN Pin Axe Perno Пин
<b>ARL TURBO ASZ TURBO</b> 4 Cyl 79.5 mm Bore Ø 1,896 cc		Length: 152.0 Outside Ø: 82.5 Flange Ø: 85.5 flange depth 4.7	STD	O/S	alfin and with oil gallery skirt MOS2 treated pin bushing inserted fits tapered con. rod	Top: 1.75 2nd: 2.0 3rd: 3.0 1st oil: 2nd oil:	Ø: 26.0 Length: 66.0
			69.8	69.55			
			Length: 69.8	69.55			
	<b>Reference no.:</b>	<b>Reference no.:</b>	<b>Reference no.:</b>	<b>Reference no.:</b>	<b>O-RING</b>		
	<b>A-SU351317 G-1402795000 K-89434190 M-029VV20</b>	<b>K-99471600 M-0308700 N-8711490046</b>			<b>A-R60370 G-0811490000 K-80000810000 K-800051640000 M-03020N0</b>		
NM-Germany Article no. Artikelnummer/ Modelo Número / статья НОМЕР	NM-Germany Article no.	NM-Germany Article no.	NM-Germany Article no.	NM-Germany Article no.	NM-Germany Article no.	NM-Germany Article no.	NM-Germany Article no.
	<b>LBSST40726DSB (for cyl 3/4)</b>	<b>LBST40726DSB</b>	<b>KBST40726DB (for cyl 3/4)</b>	<b>KBST40726DB (for cyl 3/4)</b>	<b>KRST40726DB</b>		

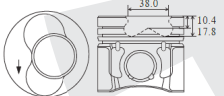

**DIESEL**

ENGINE TYPE	LINER KIT	CYL. LINER	PISTON + RINGS		PISTON SET	RINGS SET	PIN	
Motortyp Type de Moteur Tipo de motor Тип двигателя	Liner Kit Kit de Chemise Camisas de los cilindros лайнер комплект	Zylinderlaufbuchse Chemise Camisas de los cilindros втулка цилиндра	Kolben + Ringe Piston + Segments Pistón Set Поршень и кольца		Kolben Set Set de Piston Pistón Set поршеньой	Kolben Set Segments de Piston Anillos Set кольца	Pin Axe Perno Пин	
<b>AUY TURBO BVK TURBO</b>  4 Cyl  79.5 mm Bore Ø  1,896 cc		Length: 152.0 Outside Ø: 82.5 Flange Ø: 85.5 flange depth 4.7	Length: 69.8 Comp: 45.8 Height: -10.4 -17.8	STD O/S 69.55 45.55 -10.4 -17.8	alfin and with oil gallery top ring land and skirt MOS2 treated pin bushing inserted fits tapered con. rod	Top: 1.75 2nd: 2.0 3rd: 3.0 1st oil: 2nd oil:	Ø: 26.0  Length: 66.0	
		<b>Reference no.:</b>		<b>Reference no.:</b>		<b>Reference no.:</b>		<b>O-RING</b>
		A-SU351317 G-1402795000 K-89434190 M-029WV20		K-99842600 M-0305600 N-8711490005		A-R60370 G-0811490000 K-80000810000 K-800051640000 M-03020N0		
NM-Germany Article no. Artikelnummer/ Modelo Número / статья НОМЕР	NM-Germany Article no.	NM-Germany Article no.	NM-Germany Article no.	NM-Germany Article no.	NM-Germany Article no.	NM-Germany Article no.	NM-Germany Article no.	
	LBSST40727DSB (for cyl 1/2)	LBST40727DSB	KBSST40727DB (for cyl 1/2)	KBST40727DB (for cyl 1/2)	KRST40727DB			

**DIESEL**

ENGINE TYPE	LINER KIT	CYL. LINER	PISTON + RINGS		PISTON SET	RINGS SET	PIN	
Motortyp Type de Moteur Tipo de motor Тип двигателя	Liner Kit Kit de Chemise Camisas de los cilindros лайнер комплект	Zylinderlaufbuchse Chemise Camisas de los cilindros втулка цилиндра	Kolben + Ringe Piston + Segments Pistón Set Поршень и кольца		Kolben Set Set de Piston Pistón Set поршеньой	Kolben Set Segments de Piston Anillos Set кольца	Pin Axe Perno Пин	
<b>AUY TURBO BVK TURBO</b>  4 Cyl  79.5 mm Bore Ø  1,896 cc		Length: 152.0 Outside Ø: 82.5 Flange Ø: 85.5 flange depth 4.7	Length: 69.8 Comp: 45.8 Height: -10.4 -17.8	STD O/S 69.55 45.55 -10.4 -17.8	alfin and with oil gallery top ring land and skirt MOS2 treated pin bushing inserted fits tapered con. rod	Top: 1.75 2nd: 2.0 3rd: 3.0 1st oil: 2nd oil:	Ø: 26.0  Length: 66.0	
		<b>Reference no.:</b>		<b>Reference no.:</b>		<b>Reference no.:</b>		<b>O-RING</b>
		A-SU351317 G-1402795000 K-89434190 M-029WV20		K-99843600 M-0305700 N-8711490015		A-R60370 G-0811490000 K-80000810000 K-800051640000 M-03020N0		
NM-Germany Article no. Artikelnummer/ Modelo Número / статья НОМЕР	NM-Germany Article no.	NM-Germany Article no.	NM-Germany Article no.	NM-Germany Article no.	NM-Germany Article no.	NM-Germany Article no.	NM-Germany Article no.	
	LBSST40728DSB (for cyl 3/4)	LBST40728DSB	KBSST40728DB (for cyl 3/4)	KBST40728DB (for cyl 3/4)	KRST40728DB			

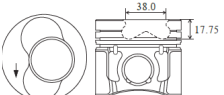
**DIESEL**

ENGINE TYPE	LINER KIT	CYL. LINER	PISTON + RINGS		PISTON SET	RINGS SET	PIN	
Motortyp Type de Moteur Tipo de motor Тип двигателя	Liner Kit Kit de Chemise Camisas de los cilindros лайнер комплект	Zylinderlaufbuchse Chemise Camisas de los cilindros втулка цилиндра	Kolben + Ringe Piston + Segments Pistón Set Поршень и кольца		Kolben Set Set de Piston Pistón Set поршеньой	Kolben Set Segments de Piston Anillos Set кольца	Pin Axe Perno Пин	
<b>ANU/ATD/AXR BVB/BKC/BXE BXF/BXJ</b>  4 Cyl  79.5 mm Bore Ø  1,896 cc		Length: 152.0 Outside Ø: 82.5 Flange Ø: 85.5 flange depth 4.7	Length: 69.8 Comp: 45.8 Height: -1.1 -17.75	STD O/S 69.55 45.55 -1.1 -17.75	alfin and with oil gallery skirt MOS2 treated pin bushing inserted fits tapered con. rod	Top: 1.75 2nd: 2.0 3rd: 3.0 1st oil: 2nd oil:	Ø: 26.0  Length: 66.0	
		<b>Reference no.:</b>		<b>Reference no.:</b>		<b>Reference no.:</b>		<b>O-RING</b>
		A-SU351317 G-1402795000 K-89434190 M-029WV20		K-99850600 M-0306500		A-R60370 G-0811490000 K-80000810000 K-800051640000 M-03020N0		
NM-Germany Article no. Artikelnummer/ Modelo Número / статья НОМЕР	NM-Germany Article no.	NM-Germany Article no.	NM-Germany Article no.	NM-Germany Article no.	NM-Germany Article no.	NM-Germany Article no.	NM-Germany Article no.	
	LBSST40729DSB (for cyl 1/2)	LBST40729DSB	KBSST40729DB (for cyl 1/2)	KBST40729DB (for cyl 1/2)	KRST40729DB			

**DIESEL**

ENGINE TYPE Motortyp Type de Moteur Tipo de motor Тип двигателя	LINER KIT Liner Kit Kit de Chemise Camisas de los cilindros лайнер комплект	CYL. LINER Zylinderlaufbuchse Chemise Camisas de los cilindros втулка цилиндра	PISTON + RINGS Kolben + Ringe Piston + Segments Pistón Set Поршень и кольца		PISTON SET Kolben Set Set de Piston Pistón Set поршневой	RINGS SET Kolben Set Segments de Piston Anillos Set кольца	PIN Pin Axe Perno Пин
<b>ANU/ATD/AXR BJB/BKC/BXE BXF/BXJ</b> 4 Cyl 79.5 mm Bore Ø 1,896 cc		Length: 152.0 Outside Ø: 82.5 Flange Ø: 85.5 flange depth 4.7	STD	O/S	alfin and with oil gallery skirt MOS2 treated pin bushing inserted fits tapered con. rod	Top: 1.75	Ø: 26.0 Length: 66.0
			Length: 69.8	69.55		2nd: 2.0	
			Comp: 45.8	45.55		3rd: 3.0	
			Height: -1.1	-1.1		1st oil: 3.0	
			-17.75	-17.75		2nd oil:	
		<b>Reference no.:</b>	<b>Reference no.:</b>	<b>Reference no.:</b>	<b>Reference no.:</b>	<b>O-RING</b>	
		<b>A-SU351317 G-1402795000 K-89434190 M-029WV20</b>	<b>K-99851600 M-0306600</b>		<b>A-R60370 G-0811490000 K-800000810000 K-800051640000 M-03020N0</b>		
NM-Germany Article no. Artikelnummer/ Modelo Número / статья НОМЕР	NM-Germany Article no.	NM-Germany Article no.	NM-Germany Article no.	NM-Germany Article no.	NM-Germany Article no.	NM-Germany Article no.	NM-Germany Article no.
	<b>LBSST40730DSB</b> (for cyl 3/4)	<b>LBST40730DSB</b>	<b>KBSST40730DB</b> (for cyl 3/4)	<b>KBST40730DB</b> (for cyl 3/4)	<b>KRST40730DB</b>		

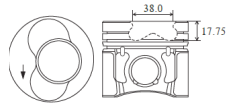

**DIESEL**

ENGINE TYPE Motortyp Type de Moteur Tipo de motor Тип двигателя	LINER KIT Liner Kit Kit de Chemise Camisas de los cilindros лайнер комплект	CYL. LINER Zylinderlaufbuchse Chemise Camisas de los cilindros втулка цилиндра	PISTON + RINGS Kolben + Ringe Piston + Segments Pistón Set Поршень и кольца		PISTON SET Kolben Set Set de Piston Pistón Set поршневой	RINGS SET Kolben Set Segments de Piston Anillos Set кольца	PIN Pin Axe Perno Пин
<b>AMF</b> 3 Cyl 79.5 mm Bore Ø 1,422 cc		Length: 152.0 Outside Ø: 82.5 Flange Ø: 85.5 flange depth 4.7	STD	O/S	alfin top ring land and skirt MOS2 treated pin bushing inserted fits tapered con. rod	Top: 1.75	Ø: 26.0 Length: 63.0
			Length: 69.8	69.8		2nd: 2.0	
			Comp: 45.8	45.5		3rd: 3.0	
			Height: -8.7	-8.7		1st oil: 3.0	
			-17.6	-17.6		2nd oil:	
		<b>Reference no.:</b>	<b>Reference no.:</b>	<b>Reference no.:</b>	<b>Reference no.:</b>	<b>O-RING</b>	
		<b>A-SU351317 G-1402795000 K-89434190 M-029WV20</b>	<b>M-0305400</b>		<b>A-R60370 G-0811490000 K-800000810000 K-800051640000 M-03020N0</b>		
NM-Germany Article no. Artikelnummer/ Modelo Número / статья НОМЕР	NM-Germany Article no.	NM-Germany Article no.	NM-Germany Article no.	NM-Germany Article no.	NM-Germany Article no.	NM-Germany Article no.	NM-Germany Article no.
	<b>LBSST30731DSA</b> (for cyl 1/2)	<b>LBST30731DSA</b>	<b>KBSST30731DA</b> (for cyl 1/2)	<b>KBST30731DA</b> (for cyl 1/2)	<b>KRST30731DA</b>		

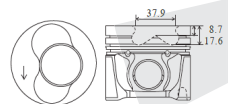



**DIESEL**

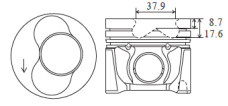

ENGINE TYPE Motortyp Type de Moteur Tipo de motor Тип двигателя	LINER KIT Liner Kit Kit de Chemise Camisas de los cilindros лайнер комплект	CYL. LINER Zylinderlaufbuchse Chemise Camisas de los cilindros втулка цилиндра	PISTON + RINGS Kolben + Ringe Piston + Segments Pistón Set Поршень и кольца		PISTON SET Kolben Set Set de Piston Pistón Set поршневой	RINGS SET Kolben Set Segments de Piston Anillos Set кольца	PIN Pin Axe Perno Пин
<b>AMF</b> 3 Cyl 79.5 mm Bore Ø 1,422 cc		Length: 152.0 Outside Ø: 82.5 Flange Ø: 85.5 flange depth 4.7	STD	O/S	alfin top ring land and skirt MOS2 treated pin bushing inserted fits tapered con. rod	Top: 1.75	Ø: 26.0 Length: 63.0
			Length: 69.8	69.8		2nd: 2.0	
			Comp: 45.8	45.5		3rd: 3.0	
			Height: -8.7	-8.7		1st oil: 3.0	
			-17.6	-17.6		2nd oil:	
		<b>Reference no.:</b>	<b>Reference no.:</b>	<b>Reference no.:</b>	<b>Reference no.:</b>	<b>O-RING</b>	
		<b>A-SU351317 G-1402795000 K-89434190 M-029WV20</b>	<b>M-0305500</b>		<b>A-R60370 G-0811490000 K-800000810000 K-800051640000 M-03020N0</b>		
NM-Germany Article no. Artikelnummer/ Modelo Número / статья НОМЕР	NM-Germany Article no.	NM-Germany Article no.	NM-Germany Article no.	NM-Germany Article no.	NM-Germany Article no.	NM-Germany Article no.	NM-Germany Article no.
	<b>LBSST30732DSA</b> (for cyl 3)	<b>LBST30732DSA</b>	<b>KBSST30732DA</b> (for cyl 3)	<b>KBST30732DA</b> (for cyl 3)	<b>KRST30732DA</b>		

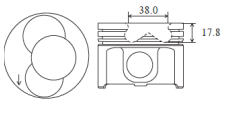

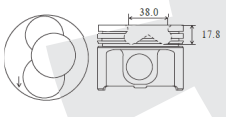

## DIESEL

ENGINE TYPE Motortyp Type de Moteur Tipo de motor Тип двигателя	LINER KIT Liner Kit Kit de Chemise Camisas de los cilindros лайнер комплект	CYL. LINER Zylinderlaufbuchse Chemise Camisas de los cilindros втулка цилиндра	PISTON + RINGS Kolben + Ringe Piston + Segments Pistón Set Поршень и кольца		PISTON SET Kolben Set Set de Piston Pistón Set поршневой	RINGS SET Kolben Set Segments de Piston Anillos Set кольца	PIN Pin Axe Perno Пин
<b>AGP/AQM</b> <b>ASY/AYQ</b> 4 Cyl 79.5 mm Bore Ø 1,896 cc 	<b>K-40092970</b> <b>M-0308090</b>	Length: 152.0 Outside Ø: 82.5 Flange Ø: 85.5 flange depth 4.7	Length: 60.8 Comp: 39.8 Height: -17.8		alfin Top: 1.75 2nd: 2.0 3rd: 3.0 1st oil: 2nd oil:	Ø: 24.0 Length: 59.0	
		Reference no.:		Reference no.:	Reference no.:	Reference no.:	O-RING
		<b>A-SU351317</b> <b>G-1402795000</b> <b>K-89434190</b> <b>M-029WV20</b>		<b>K-40092700</b> <b>M-0308000</b> <b>N-8711490020</b>			<b>A-R60370</b> <b>G-0811490000</b> <b>K-800000810000</b> <b>K-800051640000</b> <b>M-03020N0</b>
NM-Germany Article no. Artikelnummer/ Modelo Número / статья НОМЕР	NM-Germany Article no.	NM-Germany Article no.	NM-Germany Article no.	NM-Germany Article no.	NM-Germany Article no.	NM-Germany Article no.	NM-Germany Article no.
	<b>LBSST40733DSA</b> (for cyl 1/2)	<b>LBST40733DSA</b>	<b>KBSST40733DA</b> (for cyl 1/2)	<b>KBST40733DA</b> (for cyl 1/2)	<b>KRST40733DA</b>		

## DIESEL

ENGINE TYPE Motortyp Type de Moteur Tipo de motor Тип двигателя	LINER KIT Liner Kit Kit de Chemise Camisas de los cilindros лайнер комплект	CYL. LINER Zylinderlaufbuchse Chemise Camisas de los cilindros втулка цилиндра	PISTON + RINGS Kolben + Ringe Piston + Segments Pistón Set Поршень и кольца		PISTON SET Kolben Set Set de Piston Pistón Set поршневой	RINGS SET Kolben Set Segments de Piston Anillos Set кольца	PIN Pin Axe Perno Пин
<b>AGP/AQM</b> <b>ASY/AYQ</b> 4 Cyl 79.5 mm Bore Ø 1,896 cc 	<b>K-40093970</b> <b>M-0308190</b>	Length: 152.0 Outside Ø: 82.5 Flange Ø: 85.5 flange depth 4.7	Length: 60.8 Comp: 39.8 Height: -17.8		alfin Top: 1.75 2nd: 2.0 3rd: 3.0 1st oil: 2nd oil:	Ø: 24.0 Length: 59.0	
		Reference no.:		Reference no.:	Reference no.:	Reference no.:	O-RING
		<b>A-SU351317</b> <b>G-1402795000</b> <b>K-89434190</b> <b>M-029WV20</b>		<b>K-40093700</b> <b>M-0308100</b> <b>N-8711490030</b>			<b>A-R60370</b> <b>G-0811490000</b> <b>K-800000810000</b> <b>K-800051640000</b> <b>M-03020N0</b>
NM-Germany Article no. Artikelnummer/ Modelo Número / статья НОМЕР	NM-Germany Article no.	NM-Germany Article no.	NM-Germany Article no.	NM-Germany Article no.	NM-Germany Article no.	NM-Germany Article no.	NM-Germany Article no.
	<b>LBSST40734DSA</b> (for cyl 3/4)	<b>LBST40734DSA</b>	<b>KBSST40734DA</b> (for cyl 3/4)	<b>KBST40734DA</b> (for cyl 3/4)	<b>KRST40734DA</b>		

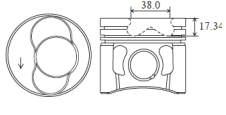
## DIESEL

ENGINE TYPE Motortyp Type de Moteur Tipo de motor Тип двигателя	LINER KIT Liner Kit Kit de Chemise Camisas de los cilindros лайнер комплект	CYL. LINER Zylinderlaufbuchse Chemise Camisas de los cilindros втулка цилиндра	PISTON + RINGS Kolben + Ringe Piston + Segments Pistón Set Поршень и кольца		PISTON SET Kolben Set Set de Piston Pistón Set поршневой	RINGS SET Kolben Set Segments de Piston Anillos Set кольца	PIN Pin Axe Perno Пин
<b>BJB/BLS</b> <b>BMT/BXE</b> <b>BXF/BXJ</b> 4 Cyl 79.5 mm Bore Ø 1,896 cc 		Length: 69.8 Outside Ø: 45.8 Flange Ø: 45.55 flange depth	Length: 69.55 Comp: 45.55 Height: -17.34	STD 0.50 0.25 1.00	alfin pin bushing inserted fits tapered con. rod	Top: 1.75 2nd: 2.0 3rd: 3.0 1st oil: 2nd oil:	Ø: 26.0 Length: 66.0
		Reference no.:		Reference no.:	Reference no.:	Reference no.:	O-RING
				<b>K-40421600</b>			<b>A-R60370</b> <b>G-0811490000</b> <b>K-800000810000</b> <b>K-800051640000</b> <b>M-03020N0</b>
NM-Germany Article no. Artikelnummer/ Modelo Número / статья НОМЕР	NM-Germany Article no.	NM-Germany Article no.	NM-Germany Article no.	NM-Germany Article no.	NM-Germany Article no.	NM-Germany Article no.	NM-Germany Article no.
			<b>KBSST40735DA</b>	<b>KBST40735DA</b>	<b>KRST40735DA</b>		

**DIESEL**

ENGINE TYPE Motortyp Type de Moteur Tipo de motor Тип двигателя	LINER KIT Liner Kit Kit de Chemise Camisas de los cilindros лайнер комплект	CYL. LINER Zylinderlaufbuchse Chemise Camisas de los cilindros втулка цилиндра	PISTON + RINGS Kolben + Ringe Piston + Segments Pistón Set Поршень и кольца		PISTON SET Kolben Set Set de Piston Pistón Set поршневой	RINGS SET Kolben Set Segments de Piston Anillos Set кольца	PIN Pin Axe Perno Пин
<b>BJB/BLS BMT/BXE BXF/BXJ</b> 4 Cyl 79.5 mm Bore Ø 1,896 cc		Length: Outside Ø: Flange Ø: flange depth	STD	0.50	alfin pin bushing inserted fits tapered con. rod	Top: 1.75 2nd: 2.0 3rd: 3.0 1st oil: 2nd oil:	Ø: 26.0 Length: 66.0
			0.25	1.00			
			Length: 69.8 Comp: 45.8 Height: -17.34	69.55			
		Reference no.:	Reference no.:	Reference no.:	Reference no.:	O-RING	
			<b>K-40422600</b>		<b>A-R60370 G-0811490000 K-800000810000 K-800051640000 M-03020N0</b>		
NM-Germany Article no. Artikelnummer/ Modelo Número / статья НОМЕР	NM-Germany Article no.	NM-Germany Article no.	NM-Germany Article no.	NM-Germany Article no.	NM-Germany Article no.	NM-Germany Article no.	
			<b>KBSST40736DA</b>	<b>KBST40736DA</b>	<b>KRST40736DA</b>		

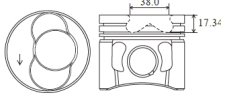

**GASOLINE**

ENGINE TYPE Motortyp Type de Moteur Tipo de motor Тип двигателя	LINER KIT Liner Kit Kit de Chemise Camisas de los cilindros лайнер комплект	CYL. LINER Zylinderlaufbuchse Chemise Camisas de los cilindros втулка цилиндра	PISTON + RINGS Kolben + Ringe Piston + Segments Pistón Set Поршень и кольца		PISTON SET Kolben Set Set de Piston Pistón Set поршневой	RINGS SET Kolben Set Segments de Piston Anillos Set кольца	PIN Pin Axe Perno Пин
<b>132 AB 132 BB</b> 4 Cyl 80.0 mm Bore Ø 1,592 cc		Length: Outside Ø: Flange Ø: flange depth	Length: 81.8			Top: 1.5 2nd: 2.0 3rd: 3.95 1st oil: 2nd oil:	Ø: 22.0 Length: 68.0
			Comp: 37.7				
			Height: 4.6				
		Reference no.:	Reference no.:	Reference no.:	Reference no.:	O-RING	
			<b>K-92472600 M-0075600</b>		<b>A-R47750 G-0820310000 K-800006141000 M-00765N0</b>		
NM-Germany Article no. Artikelnummer/ Modelo Número / статья НОМЕР	NM-Germany Article no.	NM-Germany Article no.	NM-Germany Article no.	NM-Germany Article no.	NM-Germany Article no.	NM-Germany Article no.	
			<b>KBSST40737G</b>	<b>KBST40737G</b>	<b>KRST40737G</b>		

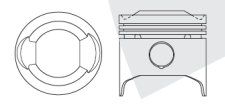

**GASOLINE**

ENGINE TYPE Motortyp Type de Moteur Tipo de motor Тип двигателя	LINER KIT Liner Kit Kit de Chemise Camisas de los cilindros лайнер комплект	CYL. LINER Zylinderlaufbuchse Chemise Camisas de los cilindros втулка цилиндра	PISTON + RINGS Kolben + Ringe Piston + Segments Pistón Set Поршень и кольца		PISTON SET Kolben Set Set de Piston Pistón Set поршневой	RINGS SET Kolben Set Segments de Piston Anillos Set кольца	PIN Pin Axe Perno Пин
<b>KR PL</b> 4 Cyl 81.0 mm Bore Ø 1,781 cc		Length: Outside Ø: Flange Ø: flange depth	Length: 63.0	62.7		Top: 1.5 2nd: 1.75 3rd: 3.0 1st oil: 2nd oil:	Ø: 20.0 Length: 57.0
			Comp: 33.4	33.1			
			Height: 0.6	0.6			
		Reference no.:	Reference no.:	Reference no.:	Reference no.:	O-RING	
			<b>K-93117600 M-0348100 N-8710940010</b>		<b>A-R60300 G-0850190000 K-800001011000 M-03475N0</b>		
NM-Germany Article no. Artikelnummer/ Modelo Número / статья НОМЕР	NM-Germany Article no.	NM-Germany Article no.	NM-Germany Article no.	NM-Germany Article no.	NM-Germany Article no.	NM-Germany Article no.	
			<b>KBSST40738G</b>	<b>KBST40738G</b>	<b>KRST40738G</b>		

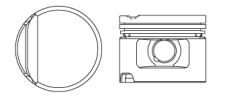

**GASOLINE**

ENGINE TYPE	LINER KIT	CYL. LINER	PISTON + RINGS		PISTON SET	RINGS SET	PIN
Motor typ Type de Moteur Tipo de motor Тип двигателя	Liner Kit Kit de Chemise Camisas de los cilindros лайнер комплект	Zylinderlaufbuchse Chemise Camisas de los cilindros втулка цилиндра	Kolben + Ringe Piston + Segments Pistón Set Поршень и кольца		Kolben Set Set de Piston Pistón Set поршневой	Kolben Set Segments de Piston Anillos Set кольца	Pin Axe Perno Пин
<b>RP</b> 4 Cyl 81.0 mm Bore Ø 1,781 cc			STD	O/S		Top: 1.5 2nd: 1.75 3rd: 3.0 1st oil: 2nd oil: 3.0	Ø: 20.0 Length: 57.0
		Length:	62.5	62.2			
		Outside Ø:	Comp: 32.2	31.9			
		Flange Ø:	Height: +1.3	+1.3			
		flange depth	-8.1	-8.1			
		Reference no.:	Reference no.:	Reference no.:	Reference no.:	O-RING	
			<b>K-93876600</b> <b>M-0347800</b> <b>N-8710970010</b>			<b>A-R60300</b> <b>G-0850190000</b> <b>K-800001011000</b> <b>M-03475N0</b>	
NM-Germany Article no. Artikelnummer/ Modelo Número / статья НОМЕР	NM-Germany Article no.	NM-Germany Article no.	NM-Germany Article no.	NM-Germany Article no.	NM-Germany Article no.	NM-Germany Article no.	NM-Germany Article no.
			<b>KBSST40739G</b>	<b>KBST40739G</b>	<b>KRST40739G</b>		

**GASOLINE**

ENGINE TYPE	LINER KIT	CYL. LINER	PISTON + RINGS		PISTON SET	RINGS SET	PIN
Motor typ Type de Moteur Tipo de motor Тип двигателя	Liner Kit Kit de Chemise Camisas de los cilindros лайнер комплект	Zylinderlaufbuchse Chemise Camisas de los cilindros втулка цилиндра	Kolben + Ringe Piston + Segments Pistón Set Поршень и кольца		Kolben Set Set de Piston Pistón Set поршневой	Kolben Set Segments de Piston Anillos Set кольца	Pin Axe Perno Пин
<b>1F</b> <b>ABN</b> <b>EZ</b> 4 Cyl 81.0 mm Bore Ø 1,595 cc			STD	O/S		Top: 1.5 2nd: 1.75 3rd: 3.0 1st oil: 2nd oil: 3.0	Ø: 20.0 Length: 57.0
		Length:	66.8	66.5			
		Outside Ø:	Comp: 35.6	35.3			
		Flange Ø:	Height: +2.2	+2.2			
		flange depth	-2.3	-2.3			
		Reference no.:	Reference no.:	Reference no.:	Reference no.:	O-RING	
			<b>K-93872600</b> <b>M-0347600</b>			<b>A-R60300</b> <b>G-0850190000</b> <b>K-800001011000</b> <b>M-03475N0</b>	
NM-Germany Article no. Artikelnummer/ Modelo Número / статья НОМЕР	NM-Germany Article no.	NM-Germany Article no.	NM-Germany Article no.	NM-Germany Article no.	NM-Germany Article no.	NM-Germany Article no.	NM-Germany Article no.
			<b>KBSST40740G</b>	<b>KBST40740G</b>	<b>KRST40740G</b>		

**GASOLINE**

ENGINE TYPE	LINER KIT	CYL. LINER	PISTON + RINGS		PISTON SET	RINGS SET	PIN
Motor typ Type de Moteur Tipo de motor Тип двигателя	Liner Kit Kit de Chemise Camisas de los cilindros лайнер комплект	Zylinderlaufbuchse Chemise Camisas de los cilindros втулка цилиндра	Kolben + Ringe Piston + Segments Pistón Set Поршень и кольца		Kolben Set Set de Piston Pistón Set поршневой	Kolben Set Segments de Piston Anillos Set кольца	Pin Axe Perno Пин
<b>AGN</b> 4 Cyl 81.0 mm Bore Ø 1,781 cc			STD	O/S		Top: 1.5 2nd: 1.75 3rd: 2.0 1st oil: 2nd oil: 2.0	Ø: 20.0 Length: 59.0
		Length:	0.25	1.00			
		Outside Ø:	56.8	56.5			
		Flange Ø:	Comp: 32.6	32.3			
		flange depth	Height: -2.5	-2.5			
		Reference no.:	Reference no.:	Reference no.:	Reference no.:	O-RING	
			<b>K-99559600</b> <b>M-0331300</b> <b>N-8750290000</b>			<b>A-R60320</b> <b>G-0850290000</b> <b>K-800045040000</b> <b>M-03304N0</b> <b>T-50017</b>	
NM-Germany Article no. Artikelnummer/ Modelo Número / статья НОМЕР	NM-Germany Article no.	NM-Germany Article no.	NM-Germany Article no.	NM-Germany Article no.	NM-Germany Article no.	NM-Germany Article no.	NM-Germany Article no.
			<b>KBSST40741G</b>	<b>KBST40741G</b>	<b>KRST40741G</b>		

**GASOLINE**

ENGINE TYPE Motortyp Type de Moteur Tipo de motor Тип двигателя	LINER KIT Liner Kit Kit de Chemise Camisas de los cilindros лайнер комплект	CYL. LINER Zylinderlaufbuchse Chemise Camisas de los cilindros втулка цилиндра	PISTON + RINGS Kolben + Ringe Piston + Segments Pistón Set Поршень и кольца		PISTON SET Kolben Set Set de Piston Pistón Set поршневой	RINGS SET Kolben Set Segments de Piston Anillos Set кольца	PIN Pin Axe Perno Пин			
			STD	O/S						
<b>AEH AFT AKL</b> 4 Cyl 81.0 mm Bore Ø 1,595 cc			Length:	53.8	53.5	skirt MOS2 treated	Top:	1.2	Ø: 20.0 Length: 57.0	
			Outside Ø:	32.0	31.7		2nd:	1.5		
			Flange Ø:	+0.7	+0.7		3rd:	2.0		
		flange depth	-2.3	-2.3			1st oil:	2.0	2nd oil:	
		Reference no.:	Reference no.:	Reference no.:	Reference no.:	O-RING				
			<b>K-94503700 M-0330100 N-8710590000</b>				<b>A-R60290 G-0810590000 K-8000039440000 M-03301N0</b>			
NM-Germany Article no. Artikelnummer/ Modelo Número / статья НОМЕР	NM-Germany Article no.	NM-Germany Article no.	NM-Germany Article no.	NM-Germany Article no.	NM-Germany Article no.	NM-Germany Article no.	NM-Germany Article no.			
			<b>KBSST40742G</b>	<b>KBST40742G</b>	<b>KRST40742G</b>					

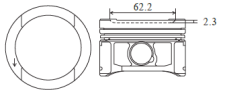

**GASOLINE**

ENGINE TYPE Motortyp Type de Moteur Tipo de motor Тип двигателя	LINER KIT Liner Kit Kit de Chemise Camisas de los cilindros лайнер комплект	CYL. LINER Zylinderlaufbuchse Chemise Camisas de los cilindros втулка цилиндра	PISTON + RINGS Kolben + Ringe Piston + Segments Pistón Set Поршень и кольца		PISTON SET Kolben Set Set de Piston Pistón Set поршневой	RINGS SET Kolben Set Segments de Piston Anillos Set кольца	PIN Pin Axe Perno Пин			
			STD	O/S						
<b>ABS/ADZ KT/PB/PF</b> 4 Cyl 81.0 mm Bore Ø 1,781 cc			Length:	62.5	62.2	skirt MOS2 treated	Top:	1.5	Ø: 20.0 Length: 57.0	
			Outside Ø:	32.2	31.9		2nd:	1.75		
			Flange Ø:	+1.3	-4.4		3rd:	3.0		
		flange depth	1.3	-4.4			1st oil:	3.0	2nd oil:	
		Reference no.:	Reference no.:	Reference no.:	Reference no.:	O-RING				
			<b>K-93928600 M-0347500 N-8710940040 N-8710940050</b>				<b>A-R60300 G-0850190000 K-800001011000 M-03475N0</b>			
NM-Germany Article no. Artikelnummer/ Modelo Número / статья НОМЕР	NM-Germany Article no.	NM-Germany Article no.	NM-Germany Article no.	NM-Germany Article no.	NM-Germany Article no.	NM-Germany Article no.	NM-Germany Article no.			
			<b>KBSST40743G</b>	<b>KBST40743G</b>	<b>KRST40743G</b>					

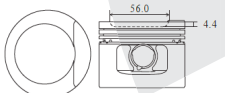

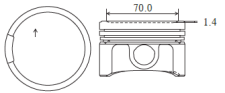

**GASOLINE**

ENGINE TYPE Motortyp Type de Moteur Tipo de motor Тип двигателя	LINER KIT Liner Kit Kit de Chemise Camisas de los cilindros лайнер комплект	CYL. LINER Zylinderlaufbuchse Chemise Camisas de los cilindros втулка цилиндра	PISTON + RINGS Kolben + Ringe Piston + Segments Pistón Set Поршень и кольца		PISTON SET Kolben Set Set de Piston Pistón Set поршневой	RINGS SET Kolben Set Segments de Piston Anillos Set кольца	PIN Pin Axe Perno Пин			
			STD	O/S						
<b>AJH/AJQ/APP AQX/AWC/AYP</b> 4 Cyl 81.0 mm Bore Ø 1,781 cc			Length:	53.7	53.4	skirt MOS2 treated	Top:	1.5	Ø: 20.0 Length: 59.0	
			Outside Ø:	32.7	32.4		2nd:	1.75		
			Flange Ø:	-1.4	-1.4		3rd:	2.0		
		flange depth					1st oil:	2.0	2nd oil:	
		Reference no.:	Reference no.:	Reference no.:	Reference no.:	O-RING				
			<b>K-99933600 M-0330400 N-8750290010</b>				<b>A-R60320 G-0850290000 K-800045040000 M-03304N0 T-50017</b>			
NM-Germany Article no. Artikelnummer/ Modelo Número / статья НОМЕР	NM-Germany Article no.	NM-Germany Article no.	NM-Germany Article no.	NM-Germany Article no.	NM-Germany Article no.	NM-Germany Article no.	NM-Germany Article no.			
			<b>KBSST40744G</b>	<b>KBST40744G</b>	<b>KRST40744G</b>					



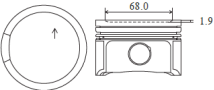

SEAT

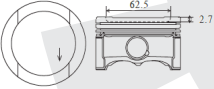

**GASOLINE**

ENGINE TYPE Motortyp Type de Moteur Tipo de motor Тип двигателя	LINER KIT Liner Kit Kit de Chemise Camisas de los cilindros лайнер комплект	CYL. LINER Zylinderlaufbuchse Chemise Camisas de los cilindros втулка цилиндра	PISTON + RINGS Kolben + Ringe Piston + Segments Pistón Set Поршень и кольца		PISTON SET Kolben Set Set de Piston Pistón Set поршневой	RINGS SET Kolben Set Segments de Piston Anillos Set кольца	PIN Pin Axe Perno Пин
<b>ARY TURBO AUQ TURBO</b> 4 Cyl 81.0 mm Bore Ø 1,781 cc  		Length: Outside Ø: Flange Ø: flange depth	STD	0.50 0.25 1.00	top and 2nd ring lands anodized skirt MOS2 treated fits tapered con. rod	Top: 1.5 2nd: 1.75 3rd: 2.0 1st oil: 2.0 2nd oil:	Ø: 19.0 Length: 50.0
			Length:	53.7		53.4	
			Comp:	32.7		32.4	
		Height:	-1.9	-1.9			
		Reference no.:	Reference no.:		Reference no.:	Reference no.:	O-RING
			<b>K-40434600 M-0331600</b>			<b>A-R60320 G-0850290000 K-800045040000 M-03304N0 T-50017</b>	
NM-Germany Article no. Artikelnummer/ Modelo Número / статья НОМЕР	NM-Germany Article no.	NM-Germany Article no.	NM-Germany Article no.	NM-Germany Article no.	NM-Germany Article no.	NM-Germany Article no.	NM-Germany Article no.
			<b>KBST40745G</b>	<b>KBST40745G</b>	<b>KRST40745G</b>		

**GASOLINE**

ENGINE TYPE Motortyp Type de Moteur Tipo de motor Тип двигателя	LINER KIT Liner Kit Kit de Chemise Camisas de los cilindros лайнер комплект	CYL. LINER Zylinderlaufbuchse Chemise Camisas de los cilindros втулка цилиндра	PISTON + RINGS Kolben + Ringe Piston + Segments Pistón Set Поршень и кольца		PISTON SET Kolben Set Set de Piston Pistón Set поршневой	RINGS SET Kolben Set Segments de Piston Anillos Set кольца	PIN Pin Axe Perno Пин
<b>BFQ/BGU/BSE BSF</b> 4 Cyl 81.0 mm Bore Ø 1,595 cc  		Length: Outside Ø: Flange Ø: flange depth	STD	O/S	skirt MOS2 treated fits tapered con. rod	Top: 1.0 2nd: 1.2 3rd: 2.0 1st oil: 2.0 2nd oil:	Ø: 19.0 Length: 42.0
			Length:	50.8		50.45	
			Comp:	29.7		29.45	
		Height:	-2.7	-2.7			
		Reference no.:	Reference no.:		Reference no.:	Reference no.:	O-RING
			<b>K-99792600 M-0332000</b>			<b>G-0814830000 K-800049841050 M-03077N0</b>	
NM-Germany Article no. Artikelnummer/ Modelo Número / статья НОМЕР	NM-Germany Article no.	NM-Germany Article no.	NM-Germany Article no.	NM-Germany Article no.	NM-Germany Article no.	NM-Germany Article no.	NM-Germany Article no.
			<b>KBST40746G</b>	<b>KBST40746G</b>	<b>KRST40746G</b>		

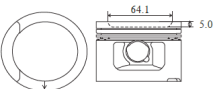
**GASOLINE**

ENGINE TYPE Motortyp Type de Moteur Tipo de motor Тип двигателя	LINER KIT Liner Kit Kit de Chemise Camisas de los cilindros лайнер комплект	CYL. LINER Zylinderlaufbuchse Chemise Camisas de los cilindros втулка цилиндра	PISTON + RINGS Kolben + Ringe Piston + Segments Pistón Set Поршень и кольца		PISTON SET Kolben Set Set de Piston Pistón Set поршневой	RINGS SET Kolben Set Segments de Piston Anillos Set кольца	PIN Pin Axe Perno Пин
<b>2E ADY AGG</b> 4 Cyl 82.5 mm Bore Ø 1,984 cc  		Length: Outside Ø: Flange Ø: flange depth	STD	O/S		Top: 1.2 2nd: 1.5 3rd: 2.0 1st oil: 2.0 2nd oil:	Ø: 21.0 Length: 59.0
			Length:	63.8		63.5	
			Comp:	30.9		30.6	
		Height:	+0.9	+0.9			
			-5.0	-5.0			
		Reference no.:	Reference no.:		Reference no.:	Reference no.:	O-RING
			<b>K-91128600 M-0349900 N-8750180070</b>			<b>A-R60310 G-0850180000 K-800001220000 K-800045720000 M-03031N0 M-03060N0 M-03075N0 M-03319N0 T-50018 T-50025</b>	
NM-Germany Article no. Artikelnummer/ Modelo Número / статья НОМЕР	NM-Germany Article no.	NM-Germany Article no.	NM-Germany Article no.	NM-Germany Article no.	NM-Germany Article no.	NM-Germany Article no.	NM-Germany Article no.
			<b>KBST40747G</b>	<b>KBST40747G</b>	<b>KRST40747G</b>		





**GASOLINE**

ENGINE TYPE Motortyp Type de Moteur Tipo de motor Тип двигателя	LINER KIT Liner Kit Kit de Chemise Camisas de los cilindros лайнер комплект	CYL. LINER Zylinderlaufbuchse Chemise Camisas de los cilindros втулка цилиндра	PISTON + RINGS Kolben + Ringe Piston + Segments Pistón Set Поршень и кольца		PISTON SET Kolben Set Set de Piston Pistón Set поршневой	RINGS SET Kolben Set Segments de Piston Anillos Set кольца	PIN Pin Axe Perno Пин	
<b>2E</b> 4 Cyl 82.5 mm Bore Ø 1,984 cc		Length: Outside Ø: Flange Ø: flange depth	Length:	Length:	skirt MOS2 treated	Top:	Ø: 21.0 Length: 56.0	
			51.8	51.5		2nd:		1.5
			Comp: 30.9	30.6		3rd:		2.0
		Flange Ø:	Height: +0.9	+0.9		1st oil:		
		flange depth	-5.7	-5.7		2nd oil:		
		Reference no.:	Reference no.:	Reference no.:	Reference no.:	O-RING		
			<b>M-0303100</b> <b>N-8750180020</b>		<b>A-R60310</b> <b>G-0850180000</b> <b>K-800001220000</b> <b>K-800045720000</b> <b>M-03031N0</b> <b>M-03060N0</b> <b>M-03075N0</b> <b>M-03319N0</b> <b>T-50018</b> <b>T-50025</b>			
NM-Germany Article no. Artikelnummer/ Modelo Número / статья НОМЕР	NM-Germany Article no.	NM-Germany Article no.	NM-Germany Article no.	NM-Germany Article no.	NM-Germany Article no.	NM-Germany Article no.	NM-Germany Article no.	
			<b>KBSST40748G</b>	<b>KBST40748G</b>	<b>KRST40748G</b>			



ENGINE TYPE Motortyp Type de Moteur Tipo de motor Тип двигателя	LINER KIT Liner Kit Kit de Chemise Camisas de los cilindros лайнер комплект	CYL. LINER Zylinderlaufbuchse Chemise Camisas de los cilindros втулка цилиндра	PISTON + RINGS Kolben + Ringe Piston + Segments Pistón Set Поршень и кольца		PISTON SET Kolben Set Set de Piston Pistón Set поршневой	RINGS SET Kolben Set Segments de Piston Anillos Set кольца	PIN Pin Axe Perno Пин	
<b>ATM/AZL</b> 4 Cyl 82.5 mm Bore Ø 1,984 cc		Length: Outside Ø: Flange Ø: flange depth	Length:	Length:		Top:	Ø: 19.0 Length: 42.0	
			51.0	29.3		2nd:		1.5
			Comp: 29.3	Height: -5.0		3rd:		2.0
		Flange Ø:				1st oil:		
		flange depth				2nd oil:		
		Reference no.:	Reference no.:	Reference no.:	Reference no.:	O-RING		
			<b>M-0309200</b>	<b>06B 107 065 B</b> <b>06B 107 065 Q</b> <b>06B 107 103 B</b>	<b>A-R60310</b> <b>G-0850180000</b> <b>K-800001220000</b> <b>K-800045720000</b> <b>M-03031N0</b> <b>M-03060N0</b> <b>M-03075N0</b> <b>M-03319N0</b> <b>T-50018</b> <b>T-50025</b>			
NM-Germany Article no. Artikelnummer/ Modelo Número / статья НОМЕР	NM-Germany Article no.	NM-Germany Article no.	NM-Germany Article no.	NM-Germany Article no.	NM-Germany Article no.	NM-Germany Article no.	NM-Germany Article no.	
			<b>KBSST40749G</b>	<b>KBST40749G</b>	<b>KRST40749G</b>			

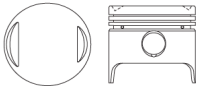

ENGINE TYPE Motortyp Type de Moteur Tipo de motor Тип двигателя	LINER KIT Liner Kit Kit de Chemise Camisas de los cilindros лайнер комплект	CYL. LINER Zylinderlaufbuchse Chemise Camisas de los cilindros втулка цилиндра	PISTON + RINGS Kolben + Ringe Piston + Segments Pistón Set Поршень и кольца		PISTON SET Kolben Set Set de Piston Pistón Set поршневой	RINGS SET Kolben Set Segments de Piston Anillos Set кольца	PIN Pin Axe Perno Пин	
<b>021 A 2000</b> 4 Cyl 83.0 mm Bore Ø 1,461 cc		Length: Outside Ø: Flange Ø: flange depth	Length:	Length:	skirt MOS2 treated	Top:	Ø: 21.0 Length: 51.9	
			69.7	39.7		2nd:		1.75
			Comp: 39.7	Height: -2.5		3rd:		4.0
		Flange Ø:				1st oil:		
		flange depth		-10.5		2nd oil:		
		Reference no.:	Reference no.:	Reference no.:	Reference no.:	O-RING		
			<b>K-90218600</b> <b>M-5681000</b>		<b>G-0834930000</b> <b>M-56810N0</b>			
NM-Germany Article no. Artikelnummer/ Modelo Número / статья НОМЕР	NM-Germany Article no.	NM-Germany Article no.	NM-Germany Article no.	NM-Germany Article no.	NM-Germany Article no.	NM-Germany Article no.	NM-Germany Article no.	
			<b>KBSST40750G</b>	<b>KBST40750G</b>	<b>KRST40750G</b>			

**GASOLINE**

ENGINE TYPE Motortyp Type de Moteur Tipo de motor Тип двигателя	LINER KIT Liner Kit Kit de Chemise Camisas de los cilindros лайнер комплект	CYL. LINER Zylinderlaufbuchse Chemise Camisas de los cilindros втулка цилиндра	PISTON + RINGS Kolben + Ringe Piston + Segments Pistón Set Поршень и кольца			PISTON SET Kolben Set Set de Piston Pistón Set поршневой	RINGS SET Kolben Set Segments de Piston Anillos Set кольца	PIN Pin Axe Perno Пин	
<b>131 C4</b> 4 Cyl 84.0 mm Bore Ø 1,995 cc 		Length:			Length:	77.9	Top:	1.5	Ø: 22.0 Length: 69.0
		Outside Ø:			Comp:	38.4	2nd:	2.0	
		Flange Ø:			Height:	-4.5	3rd:	3.95	
		flange depth				-5.1	1st oil:	3.95	
			Reference no.:		Reference no.:		Reference no.:		O-RING
					<b>K-93279600</b> <b>M-0086600</b>		<b>A-R46970</b> <b>G-0821530010</b> <b>K-800006541000</b> <b>M-00865N0</b>		
NM-Germany Article no. Artikelnummer/ Modelo Número / статья НОМЕР	NM-Germany Article no.	NM-Germany Article no.	NM-Germany Article no.	NM-Germany Article no.	NM-Germany Article no.	NM-Germany Article no.	NM-Germany Article no.	NM-Germany Article no.	NM-Germany Article no.
			<b>KBSST40751G</b>	<b>KBST40751G</b>	<b>KRST40751G</b>				

**GASOLINE**

ENGINE TYPE Motortyp Type de Moteur Tipo de motor Тип двигателя	LINER KIT Liner Kit Kit de Chemise Camisas de los cilindros лайнер комплект	CYL. LINER Zylinderlaufbuchse Chemise Camisas de los cilindros втулка цилиндра	PISTON + RINGS Kolben + Ringe Piston + Segments Pistón Set Поршень и кольца			PISTON SET Kolben Set Set de Piston Pistón Set поршневой	RINGS SET Kolben Set Segments de Piston Anillos Set кольца	PIN Pin Axe Perno Пин	
<b>132 AB</b> <b>132 B</b> <b>132 BB</b> 4 Cyl 84.0 mm Bore Ø 1,756 cc 		Length:			Length:	79.9	Top:	1.5	Ø: 22.0 Length: 69.0
		Outside Ø:			Comp:	38.4	2nd:	2.0	
		Flange Ø:			Height:	2.0	3rd:	3.95	
		flange depth					1st oil:	3.95	
			Reference no.:		Reference no.:		Reference no.:		O-RING
					<b>K-92425600</b> <b>M-0077500</b>		<b>A-R46970</b> <b>G-0821530010</b> <b>K-800006541000</b> <b>M-00865N0</b>		
NM-Germany Article no. Artikelnummer/ Modelo Número / статья НОМЕР	NM-Germany Article no.	NM-Germany Article no.	NM-Germany Article no.	NM-Germany Article no.	NM-Germany Article no.	NM-Germany Article no.	NM-Germany Article no.	NM-Germany Article no.	NM-Germany Article no.
			<b>KBSST40752G</b>	<b>KBST40752G</b>	<b>KRST40752G</b>				

ENGINE TYPE Motortyp Type de Moteur Tipo de motor Тип двигателя	LINER KIT Liner Kit Kit de Chemise Camisas de los cilindros лайнер комплект	CYL. LINER Zylinderlaufbuchse Chemise Camisas de los cilindros втулка цилиндра	PISTON + RINGS Kolben + Ringe Piston + Segments Pistón Set Поршень и кольца			PISTON SET Kolben Set Set de Piston Pistón Set поршневой	RINGS SET Kolben Set Segments de Piston Anillos Set кольца	PIN Pin Axe Perno Пин				
<b>8144.61</b> 4 Cyl 93.0 mm Bore Ø 2,429 cc 2,445 cc 	(A) <b>K-93378970</b> <b>M-0079890</b> consists of (C) (B) <b>K-93378971</b> <b>M-0079892</b> consists of (D)	(C)	(D)				alfin head anodized	Top:	3.0	Ø: 32.0 Length: 74.4		
		Length:	167.0	167.3	Length:			Comp:			2nd:	2.0
		Outside Ø:	96.0	96.0	Comp:			Height:			3rd:	4.0
		Flange Ø:						1st oil:	4.0			
		flange depth		5.0				2nd oil:				
			Reference no.:		Reference no.:		Reference no.:		O-RING			
		(C)	<b>A-SU351407</b> <b>K-89066190</b> <b>M-007WV39</b>	(D)	<b>G-1402256000</b> <b>K-89183190</b> <b>M-007WV43</b>		<b>A-A350663</b> <b>K-93378700</b> <b>M-0079800</b> <b>N-8721450000</b>		<b>A-R47010</b> <b>G-0821450010</b> <b>K-8000070400</b> <b>M-00798V0</b>			
NM-Germany Article no. Artikelnummer/ Modelo Número / статья НОМЕР	NM-Germany Article no.	NM-Germany Article no.	NM-Germany Article no.	NM-Germany Article no.	NM-Germany Article no.	NM-Germany Article no.	NM-Germany Article no.	NM-Germany Article no.	NM-Germany Article no.	NM-Germany Article no.		
	<b>LBSST40753DPA (A)</b> <b>LBSST40753DSA (B)</b>	<b>LBST40753DPA (C)</b> <b>LBST40753DSA (D)</b>	<b>KBSST40753D</b>	<b>KBST40753D</b>	<b>KRST40753D</b>							

**GASOLINE**

ENGINE TYPE Motortyp Type de Moteur Tipo de motor Тип двигателя	LINER KIT Liner Kit Kit de Chemise Camisas de los cilindros лайнер комплект	CYL. LINER Zylinderlaufbuchse Chemise Camisas de los cilindros втулка цилиндра	PISTON + RINGS Kolben + Ringe Piston + Segments Pistón Set Поршень и кольца		PISTON SET Kolben Set Set de Piston Pistón Set поршневой	RINGS SET Kolben Set Segments de Piston Anillos Set кольца	PIN Pin Axe Perno Пин
<b>AEE</b> 4 Cyl 76.5 mm Bore Ø 1,598 cc		Length: Outside Ø: Flange Ø: flange depth	STD	O/S	skirt MOS2 treated	Top: 1.2	Ø: 17.0 Length: 52.0
			Length: 60.2	60.0		2nd: 1.5	
			Comp: 30.9	30.65		3rd: 2.5	
			Height: -7.8	-7.8		1st oil: 2.5	
			Reference no.:	Reference no.:	Reference no.:	Reference no.:	O-RING
			<b>K-94553600 M-0304200 N-8750280010</b>			<b>A-R60280 G-0850280000 K-800026140000 M-03032N0</b>	
NM-Germany Article no. Artikelnummer/ Modelo Número / статья НОМЕР	NM-Germany Article no.	NM-Germany Article no.	NM-Germany Article no.	NM-Germany Article no.	NM-Germany Article no.	NM-Germany Article no.	NM-Germany Article no.
			<b>KBSSK40754G</b>	<b>KBSK40754G</b>	<b>KRSK40754G</b>		



**GASOLINE**

ENGINE TYPE Motortyp Type de Moteur Tipo de motor Тип двигателя	LINER KIT Liner Kit Kit de Chemise Camisas de los cilindros лайнер комплект	CYL. LINER Zylinderlaufbuchse Chemise Camisas de los cilindros втулка цилиндра	PISTON + RINGS Kolben + Ringe Piston + Segments Pistón Set Поршень и кольца		PISTON SET Kolben Set Set de Piston Pistón Set поршневой	RINGS SET Kolben Set Segments de Piston Anillos Set кольца	PIN Pin Axe Perno Пин
<b>AUA AXP</b> 4 Cyl 76.5 mm Bore Ø 1,390 cc		Length: Outside Ø: Flange Ø: flange depth	STD	O/S	skirt MOS2 treated	Top: 1.2	Ø: 17.0 Length: 54.0
			Length: 50.0	49.75		2nd: 1.5	
			Comp: 29.0	28.75		3rd: 2.5	
			Height: -2.0	-2.0		1st oil: 2.5	
			flange depth	-2.3	-2.3	2nd oil:	
			Reference no.:	Reference no.:	Reference no.:	Reference no.:	O-RING
			<b>K-99562600 M-0306100 N-8711610000</b>			<b>A-R60280 G-0850280000 K-800026140000 M-03032N0</b>	
NM-Germany Article no. Artikelnummer/ Modelo Número / статья НОМЕР	NM-Germany Article no.	NM-Germany Article no.	NM-Germany Article no.	NM-Germany Article no.	NM-Germany Article no.	NM-Germany Article no.	NM-Germany Article no.
			<b>KBSSK40755G</b>	<b>KBSK40755G</b>	<b>KRSK40755G</b>		

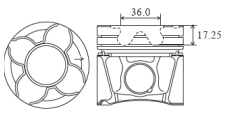

**GASOLINE**

ENGINE TYPE Motortyp Type de Moteur Tipo de motor Тип двигателя	LINER KIT Liner Kit Kit de Chemise Camisas de los cilindros лайнер комплект	CYL. LINER Zylinderlaufbuchse Chemise Camisas de los cilindros втулка цилиндра	PISTON + RINGS Kolben + Ringe Piston + Segments Pistón Set Поршень и кольца		PISTON SET Kolben Set Set de Piston Pistón Set поршневой	RINGS SET Kolben Set Segments de Piston Anillos Set кольца	PIN Pin Axe Perno Пин
<b>AEX APQ</b> 4 Cyl 76.5 mm Bore Ø 1,389 cc		Length: Outside Ø: Flange Ø: flange depth	STD	0.50	skirt MOS2 treated pin boss gap=20.2mm	Top: 1.2	Ø: 17.0 Length: 52.0
			Length: 50.35	50.1		2nd: 1.5	
			Comp: 28.35	28.1		3rd: 2.5	
			Height: -5.95	-5.7		1st oil: 2.5	
			Reference no.:	Reference no.:	Reference no.:	Reference no.:	O-RING
			<b>M-0303200 N-8750280000</b>			<b>A-R60280 G-0850280000 K-800026140000 M-03032N0</b>	
NM-Germany Article no. Artikelnummer/ Modelo Número / статья НОМЕР	NM-Germany Article no.	NM-Germany Article no.	NM-Germany Article no.	NM-Germany Article no.	NM-Germany Article no.	NM-Germany Article no.	NM-Germany Article no.
			<b>KBSSK40756G</b>	<b>KBSK40756G</b>	<b>KRSK40756G</b>		

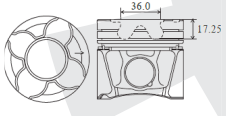

**DIESEL**

ENGINE TYPE Motortyp Type de Moteur Tipo de motor Тип двигателя	LINER KIT Liner Kit Kit de Chemise Camisas de los cilindros лайнер комплект	CYL. LINER Zylinderlaufbuchse Chemise Camisas de los cilindros втулка цилиндра	PISTON + RINGS Kolben + Ringe Piston + Segments Pistón Set Поршень и кольца		PISTON SET Kolben Set Set de Piston Pistón Set поршневой	RINGS SET Kolben Set Segments de Piston Anillos Set кольца	PIN Pin Axe Perno Пин
<b>AYM TURBO</b> 6 Cyl 78.3 mm Bore Ø 2,496 cc 		Length: 155.0	Length: 71.83	71.83	alfin and with oil gallery skirt MOS2 treated fits tapered con. rod	Top: 1.75	Ø: 26.0 Length: 58.0
		Outside Ø: 82.0	Comp: 47.83	47.58		2nd: 2.0	
		Flange Ø: 84.0	Height: -1.38	-1.38		3rd: 3.0	
		flange depth 3.0	-17.25	-17.25		1st oil: 3.0	
		<b>Reference no.:</b>	<b>Reference no.:</b>	<b>Reference no.:</b>	<b>Reference no.:</b>	<b>O-RING</b>	
			<b>K-99534600</b> <b>M-0334200</b>		<b>A-R66900</b> <b>G-0810300000</b> <b>K-800051540000</b> <b>M-03340V0</b>		
NM-Germany Article no. Artikelnummer/ Modelo Número / статья НОМЕР	NM-Germany Article no.	NM-Germany Article no.	NM-Germany Article no.	NM-Germany Article no.	NM-Germany Article no.	NM-Germany Article no.	NM-Germany Article no.
	<b>LBSSK60757DSB</b> (for cyl 1/2/3)	<b>LBSK60757DSB</b>	<b>KBSSK60757DB</b> (for cyl 1/2/3)	<b>KBSK60757DB</b> (for cyl 1/2/3)	<b>KRSK60757DB</b>		

**DIESEL**

ENGINE TYPE Motortyp Type de Moteur Tipo de motor Тип двигателя	LINER KIT Liner Kit Kit de Chemise Camisas de los cilindros лайнер комплект	CYL. LINER Zylinderlaufbuchse Chemise Camisas de los cilindros втулка цилиндра	PISTON + RINGS Kolben + Ringe Piston + Segments Pistón Set Поршень и кольца		PISTON SET Kolben Set Set de Piston Pistón Set поршневой	RINGS SET Kolben Set Segments de Piston Anillos Set кольца	PIN Pin Axe Perno Пин
<b>AYM TURBO</b> 6 Cyl 78.3 mm Bore Ø 2,496 cc 		Length: 155.0	Length: 71.83	71.83	alfin and with oil gallery skirt MOS2 treated fits tapered con. rod	Top: 1.75	Ø: 26.0 Length: 58.0
		Outside Ø: 82.0	Comp: 47.83	47.58		2nd: 2.0	
		Flange Ø: 84.0	Height: -1.38	-1.38		3rd: 3.0	
		flange depth 3.0	-17.25	-17.25		1st oil: 3.0	
		<b>Reference no.:</b>	<b>Reference no.:</b>	<b>Reference no.:</b>	<b>Reference no.:</b>	<b>O-RING</b>	
			<b>K-99535600</b> <b>M-0334300</b>		<b>A-R66900</b> <b>G-0810300000</b> <b>K-800051540000</b> <b>M-03340V0</b>		
NM-Germany Article no. Artikelnummer/ Modelo Número / статья НОМЕР	NM-Germany Article no.	NM-Germany Article no.	NM-Germany Article no.	NM-Germany Article no.	NM-Germany Article no.	NM-Germany Article no.	NM-Germany Article no.
	<b>LBSSK60758DSB</b> (for cyl 4/5/6)	<b>LBSK60758DSB</b>	<b>KBSSK60758DB</b> (for cyl 4/5/6)	<b>KBSK60758DB</b> (for cyl 4/5/6)	<b>KRSK60758DB</b>		

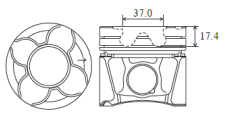
**DIESEL**

ENGINE TYPE Motortyp Type de Moteur Tipo de motor Тип двигателя	LINER KIT Liner Kit Kit de Chemise Camisas de los cilindros лайнер комплект	CYL. LINER Zylinderlaufbuchse Chemise Camisas de los cilindros втулка цилиндра	PISTON + RINGS Kolben + Ringe Piston + Segments Pistón Set Поршень и кольца		PISTON SET Kolben Set Set de Piston Pistón Set поршневой	RINGS SET Kolben Set Segments de Piston Anillos Set кольца	PIN Pin Axe Perno Пин
<b>BDG TURBO</b> 6 Cyl 78.3 mm Bore Ø 2,496 cc 	<b>K-99542600</b> <b>A-R66900</b> <b>G-0810300000</b> <b>K-800051540000</b> <b>M-03340V0</b>	Length: 155.0	Length: 71.83	71.58	alfin and with oil gallery skirt MOS2 treated fits tapered con. rod	Top: 1.75	Ø: 26.0 Length: 58.0
		Outside Ø: 82.0	Comp: 47.83	47.58		2nd: 2.0	
		Flange Ø: 84.0	Height: -1.38	-1.38		3rd: 3.0	
		flange depth 3.0	-17.4	-17.4		1st oil: 3.0	
		<b>Reference no.:</b>	<b>Reference no.:</b>	<b>Reference no.:</b>	<b>Reference no.:</b>	<b>O-RING</b>	
NM-Germany Article no. Artikelnummer/ Modelo Número / статья НОМЕР	NM-Germany Article no.	NM-Germany Article no.	NM-Germany Article no.	NM-Germany Article no.	NM-Germany Article no.	NM-Germany Article no.	NM-Germany Article no.
	<b>LBSSK60759DSB</b> (for cyl 1/2/3)	<b>LBSK60759DSB</b>	<b>KBSSK60759DB</b> (for cyl 1/2/3)	<b>KBSK60759DB</b> (for cyl 1/2/3)	<b>KRSK60759DB</b>		

**DIESEL**

ENGINE TYPE Motortyp Type de Moteur Tipo de motor Тип двигателя	LINER KIT Liner Kit Kit de Chemise Camisas de los cilindros лайнер комплект	CYL. LINER Zylinderlaufbuchse Chemise Camisas de los cilindros втулка цилиндра	PISTON + RINGS Kolben + Ringe Piston + Segments Pistón Set Поршень и кольца		PISTON SET Kolben Set Set de Piston Pistón Set поршневой	RINGS SET Kolben Set Segments de Piston Anillos Set кольца	PIN Pin Axe Perno Пин
<b>BDG TURBO</b> <b>6 Cyl</b> <b>78.3 mm Bore Ø</b> <b>2,496 cc</b>	<b>K-99543600</b> <b>A-R66900</b> <b>G-0810300000</b> <b>K-800051540000</b> <b>M-03340V0</b>	Length: 155.0 Outside Ø: 82.0 Flange Ø: 84.0 flange depth 3.0	STD	O/S	alfin and with oil gallery skirt MOS2 treated fits tapered con. rod	Top: 1.75	Ø: 26.0 Length: 58.0
			Length: 71.83	71.58		2nd: 2.0	
			Comp: 47.83	47.58		3rd: 3.0	
			Height: -1.38	-1.38		1st oil: 3.0	
			-17.4	-17.4		2nd oil:	
			Reference no.:	Reference no.:	Reference no.:	Reference no.:	O-RING
NM-Germany Article no. Artikelnummer/ Modelo Número / статья НОМЕР	NM-Germany Article no.	NM-Germany Article no.	NM-Germany Article no.	NM-Germany Article no.	NM-Germany Article no.	NM-Germany Article no.	NM-Germany Article no.
	<b>LBSSK60760DSB</b> (for cyl 4/5/6)	<b>LBSK60760DSB</b>	<b>KBSSK60760DB</b> (for cyl 4/5/6)	<b>KBSK60760DB</b> (for cyl 4/5/6)	<b>KRSK60760DB</b>		

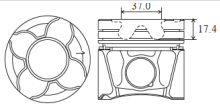

**DIESEL**

ENGINE TYPE Motortyp Type de Moteur Tipo de motor Тип двигателя	LINER KIT Liner Kit Kit de Chemise Camisas de los cilindros лайнер комплект	CYL. LINER Zylinderlaufbuchse Chemise Camisas de los cilindros втулка цилиндра	PISTON + RINGS Kolben + Ringe Piston + Segments Pistón Set Поршень и кольца		PISTON SET Kolben Set Set de Piston Pistón Set поршневой	RINGS SET Kolben Set Segments de Piston Anillos Set кольца	PIN Pin Axe Perno Пин
<b>1Z/AFN TURBO</b> <b>AGD/AHF/ASV TURBO</b> <b>4 Cyl</b> <b>79.5 mm Bore Ø</b> <b>1,896 cc</b>	<b>K-94427970</b>	Length: 152.0 Outside Ø: 82.5 Flange Ø: 85.5 flange depth 4.7	STD	0.50	alfin top ring land and skirt MOS2 treated pin bushing inserted	Top: 1.75	Ø: 26.0 Length: 66.0
			Length: 71.8	71.8		2nd: 2.0	
			Comp: 45.8	45.55		3rd: 3.0	
			Height: -8.8	-8.8		1st oil: 3.0	
			-17.75	-17.75		2nd oil:	
			Reference no.:	Reference no.:	Reference no.:	Reference no.:	O-RING
			<b>A-SU351317</b> <b>G-1402795000</b> <b>K-89434190</b> <b>M-029VW20</b>	<b>K-94427700</b> <b>M-0304000</b> <b>N-8711490095</b>		<b>A-R60370</b> <b>G-0811490000</b> <b>K-80000810000</b> <b>K-800051640000</b> <b>M-03020N0</b>	
NM-Germany Article no. Artikelnummer/ Modelo Número / статья НОМЕР	NM-Germany Article no.	NM-Germany Article no.	NM-Germany Article no.	NM-Germany Article no.	NM-Germany Article no.	NM-Germany Article no.	NM-Germany Article no.
	<b>LBSSK40761DSA</b> (for cyl 1/2)	<b>LBSK40761DSA</b>	<b>KBSSK40761DA</b> (for cyl 1/2)	<b>KBSK40761DA</b> (for cyl 1/2)	<b>KRSK40761DA</b>		

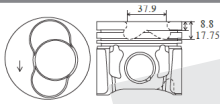

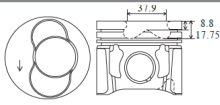

**DIESEL**

ENGINE TYPE Motortyp Type de Moteur Tipo de motor Тип двигателя	LINER KIT Liner Kit Kit de Chemise Camisas de los cilindros лайнер комплект	CYL. LINER Zylinderlaufbuchse Chemise Camisas de los cilindros втулка цилиндра	PISTON + RINGS Kolben + Ringe Piston + Segments Pistón Set Поршень и кольца		PISTON SET Kolben Set Set de Piston Pistón Set поршневой	RINGS SET Kolben Set Segments de Piston Anillos Set кольца	PIN Pin Axe Perno Пин
<b>1Z/AFN TURBO</b> <b>AGD/AHF/ASV TURBO</b> <b>4 Cyl</b> <b>79.5 mm Bore Ø</b> <b>1,896 cc</b>	<b>K-94428970</b>	Length: 152.0 Outside Ø: 82.5 Flange Ø: 85.5 flange depth 4.7	STD	0.50	alfin top ring land and skirt MOS2 treated pin bushing inserted	Top: 1.75	Ø: 26.0 Length: 66.0
			Length: 71.8	71.8		2nd: 2.0	
			Comp: 45.8	45.55		3rd: 3.0	
			Height: -8.8	-8.8		1st oil: 3.0	
			-17.75	-17.75		2nd oil:	
			Reference no.:	Reference no.:	Reference no.:	Reference no.:	O-RING
			<b>A-SU351317</b> <b>G-1402795000</b> <b>K-89434190</b> <b>M-029VW20</b>	<b>K-94428700</b> <b>M-0304100</b> <b>N-8711490090</b>		<b>A-R60370</b> <b>G-0811490000</b> <b>K-80000810000</b> <b>K-800051640000</b> <b>M-03020N0</b>	
NM-Germany Article no. Artikelnummer/ Modelo Número / статья НОМЕР	NM-Germany Article no.	NM-Germany Article no.	NM-Germany Article no.	NM-Germany Article no.	NM-Germany Article no.	NM-Germany Article no.	NM-Germany Article no.
	<b>LBSSK40762DSA</b> (for cyl 3/4)	<b>LBSK40762DSA</b>	<b>KBSSK40762DA</b> (for cyl 3/4)	<b>KBSK40762DA</b> (for cyl 3/4)	<b>KRSK40762DA</b>		





SKODA

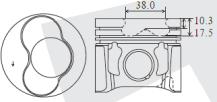

**DIESEL**

ENGINE TYPE Motortyp Type de Moteur Tipo de motor Тип двигателя	LINER KIT Liner Kit Kit de Chemise Camisas de los cilindros лайнер комплект	CYL. LINER Zylinderlaufbuchse Chemise Camisas de los cilindros втулка цилиндра	PISTON + RINGS Kolben + Ringe Piston + Segments Pistón Set Поршень и кольца		PISTON SET Kolben Set Set de Piston Pistón Set поршень	RINGS SET Kolben Set Segments de Piston Anillos Set кольца	PIN Pin Axe Perno Пин	
<b>1Y</b> <b>AEF</b> 4 Cyl 79.5 mm Bore Ø 1,896 cc 	<b>K-91386960</b> <b>M-0298290</b>	Length: 152.0 Outside Ø: 82.5 Flange Ø: 85.5 flange depth: 4.7	STD	O/S	alfin	Top: 1.75 2nd: 2.0 3rd: 3.0 1st oil: 3.0 2nd oil:	Ø: 24.0 Length: 64.0	
			0.25	1.00				
			Length: 65.7	65.7				
Reference no.:		Reference no.:		Reference no.:		Reference no.:		O-RING
<b>A-SU351317</b> <b>G-1402795000</b> <b>K-89434190</b> <b>M-029WV20</b>		<b>K-91386600</b> <b>M-0298200</b> <b>N-8799010040</b>				<b>A-R60370</b> <b>G-0811490000</b> <b>K-80000810000</b> <b>K-800051640000</b> <b>M-03020N0</b>		
NM-Germany Article no. Artikelnummer/ Modelo Número / статья НОМЕР	NM-Germany Article no.	NM-Germany Article no.	NM-Germany Article no.	NM-Germany Article no.	NM-Germany Article no.	NM-Germany Article no.	NM-Germany Article no.	
	LBSK40763DSA	LBSK40763DSA	KBSSK40763DA	KBSK40763DA	KRSK40763DA			

**DIESEL**

ENGINE TYPE Motortyp Type de Moteur Tipo de motor Тип двигателя	LINER KIT Liner Kit Kit de Chemise Camisas de los cilindros лайнер комплект	CYL. LINER Zylinderlaufbuchse Chemise Camisas de los cilindros втулка цилиндра	PISTON + RINGS Kolben + Ringe Piston + Segments Pistón Set Поршень и кольца		PISTON SET Kolben Set Set de Piston Pistón Set поршень	RINGS SET Kolben Set Segments de Piston Anillos Set кольца	PIN Pin Axe Perno Пин	
<b>ASZ TURBO</b> <b>AWX TURBO</b> 4 Cyl 79.5 mm Bore Ø 1,896 cc 		Length: 152.0 Outside Ø: 82.5 Flange Ø: 85.5 flange depth: 4.7	STD	O/S	alfin and with oil gallery skirt MOS2 treated pin bushing inserted fits tapered con. rod	Top: 1.75 2nd: 2.0 3rd: 3.0 1st oil: 3.0 2nd oil:	Ø: 26.0 Length: 66.0	
			69.8	69.55				
			Length: 65.7	65.7				
Reference no.:		Reference no.:		Reference no.:		Reference no.:		O-RING
<b>A-SU351317</b> <b>G-1402795000</b> <b>K-89434190</b> <b>M-029WV20</b>		<b>K-99470600</b> <b>M-0308600</b> <b>N-8711490045</b>				<b>A-R60370</b> <b>G-0811490000</b> <b>K-80000810000</b> <b>K-800051640000</b> <b>M-03020N0</b>		
NM-Germany Article no. Artikelnummer/ Modelo Número / статья НОМЕР	NM-Germany Article no.	NM-Germany Article no.	NM-Germany Article no.	NM-Germany Article no.	NM-Germany Article no.	NM-Germany Article no.	NM-Germany Article no.	
	LBSK40764DSB (for cyl 1/2)	LBSK40764DSB	KBSSK40764DB (for cyl 1/2)	KBSK40764DB (for cyl 1/2)	KRSK40764DB			

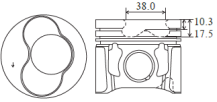
**DIESEL**

ENGINE TYPE Motortyp Type de Moteur Tipo de motor Тип двигателя	LINER KIT Liner Kit Kit de Chemise Camisas de los cilindros лайнер комплект	CYL. LINER Zylinderlaufbuchse Chemise Camisas de los cilindros втулка цилиндра	PISTON + RINGS Kolben + Ringe Piston + Segments Pistón Set Поршень и кольца		PISTON SET Kolben Set Set de Piston Pistón Set поршень	RINGS SET Kolben Set Segments de Piston Anillos Set кольца	PIN Pin Axe Perno Пин	
<b>ASZ TURBO</b> <b>AWX TURBO</b> 4 Cyl 79.5 mm Bore Ø 1,896 cc 		Length: 152.0 Outside Ø: 82.5 Flange Ø: 85.5 flange depth: 4.7	STD	O/S	alfin and with oil gallery skirt MOS2 treated pin bushing inserted fits tapered con. rod	Top: 1.75 2nd: 2.0 3rd: 3.0 1st oil: 3.0 2nd oil:	Ø: 26.0 Length: 66.0	
			69.8	69.55				
			Length: 65.7	65.7				
Reference no.:		Reference no.:		Reference no.:		Reference no.:		O-RING
<b>A-SU351317</b> <b>G-1402795000</b> <b>K-89434190</b> <b>M-029WV20</b>		<b>K-99471600</b> <b>M-0308700</b> <b>N-8711490046</b>				<b>A-R60370</b> <b>G-0811490000</b> <b>K-80000810000</b> <b>K-800051640000</b> <b>M-03020N0</b>		
NM-Germany Article no. Artikelnummer/ Modelo Número / статья НОМЕР	NM-Germany Article no.	NM-Germany Article no.	NM-Germany Article no.	NM-Germany Article no.	NM-Germany Article no.	NM-Germany Article no.	NM-Germany Article no.	
	LBSK40765DSB (for cyl 3/4)	LBSK40765DSB	KBSSK40765DB (for cyl 3/4)	KBSK40765DB (for cyl 3/4)	KRSK40765DB			

**DIESEL**

ENGINE TYPE Motortyp Type de Moteur Tipo de motor Тип двигателя	LINER KIT Liner Kit Kit de Chemise Camisas de los cilindros лайнер комплект	CYL. LINER Zylinderlaufbuchse Chemise Camisas de los cilindros втулка цилиндра	PISTON + RINGS Kolben + Ringe Piston + Segments Pistón Set Поршень и кольца		PISTON SET Kolben Set Set de Piston Pistón Set поршневой	RINGS SET Kolben Set Segments de Piston Anillos Set кольца	PIN Pin Axe Perno Пин
<b>ATD/AVB/AXR BJB/BKC BSW/BXE</b>  <b>4 Cyl</b> <b>79.5 mm Bore Ø</b> <b>1,896 cc</b>		Length: 152.0 Outside Ø: 82.5 Flange Ø: 85.5 flange depth 4.7	STD	O/S	alfin and with oil gallery skirt MOS2 treated pin bushing inserted fits tapered con. rod	Top: 1.75	Ø: 26.0  Length: 66.0
			Length: 69.8	69.55		2nd: 2.0	
			Comp: 45.8	45.55		3rd: 3.0	
			Height: -1.1	-1.1		1st oil: 3.0	
			-17.75	-17.75		2nd oil:	
			Reference no.:		Reference no.:	Reference no.:	O-RING
			<b>A-SU351317 G-1402795000 K-89434190 M-029WV20</b>		<b>K-99850600 M-0306500</b>	<b>A-R60370 G-0811490000 K-800000810000 K-800051640000 M-03020N0</b>	
NM-Germany Article no. Artikelnummer/ Modelo Número / статья НОМЕР	NM-Germany Article no.	NM-Germany Article no.	NM-Germany Article no.	NM-Germany Article no.	NM-Germany Article no.	NM-Germany Article no.	NM-Germany Article no.
	<b>LBSSK40766DSB</b> (for cyl 1/2)	<b>LBSK40766DSB</b>	<b>KBSSK40766DB</b> (for cyl 1/2)	<b>KBSK40766DB</b> (for cyl 1/2)	<b>KRSK40766DB</b>		

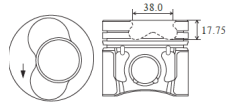

**DIESEL**

ENGINE TYPE Motortyp Type de Moteur Tipo de motor Тип двигателя	LINER KIT Liner Kit Kit de Chemise Camisas de los cilindros лайнер комплект	CYL. LINER Zylinderlaufbuchse Chemise Camisas de los cilindros втулка цилиндра	PISTON + RINGS Kolben + Ringe Piston + Segments Pistón Set Поршень и кольца		PISTON SET Kolben Set Set de Piston Pistón Set поршневой	RINGS SET Kolben Set Segments de Piston Anillos Set кольца	PIN Pin Axe Perno Пин
<b>ATD/AVB/AXR BJB/BKC BSW/BXE</b>  <b>4 Cyl</b> <b>79.5 mm Bore Ø</b> <b>1,896 cc</b>		Length: 152.0 Outside Ø: 82.5 Flange Ø: 85.5 flange depth 4.7	STD	O/S	alfin and with oil gallery skirt MOS2 treated pin bushing inserted fits tapered con. rod	Top: 1.75	Ø: 26.0  Length: 66.0
			Length: 69.8	69.55		2nd: 2.0	
			Comp: 45.8	45.55		3rd: 3.0	
			Height: -1.1	-1.1		1st oil: 3.0	
			-17.75	-17.75		2nd oil:	
			Reference no.:		Reference no.:	Reference no.:	O-RING
			<b>A-SU351317 G-1402795000 K-89434190 M-029WV20</b>		<b>K-99851600 M-0306600</b>	<b>A-R60370 G-0811490000 K-800000810000 K-800051640000 M-03020N0</b>	
NM-Germany Article no. Artikelnummer/ Modelo Número / статья НОМЕР	NM-Germany Article no.	NM-Germany Article no.	NM-Germany Article no.	NM-Germany Article no.	NM-Germany Article no.	NM-Germany Article no.	NM-Germany Article no.
	<b>LBSSK40767DSB</b> (for cyl 3/4)	<b>LBSK40767DSB</b>	<b>KBSSK40767DB</b> (for cyl 3/4)	<b>KBSK40767DB</b> (for cyl 3/4)	<b>KRSK40767DB</b>		

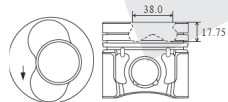

**DIESEL**

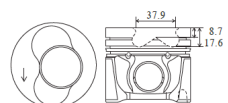

ENGINE TYPE Motortyp Type de Moteur Tipo de motor Тип двигателя	LINER KIT Liner Kit Kit de Chemise Camisas de los cilindros лайнер комплект	CYL. LINER Zylinderlaufbuchse Chemise Camisas de los cilindros втулка цилиндра	PISTON + RINGS Kolben + Ringe Piston + Segments Pistón Set Поршень и кольца		PISTON SET Kolben Set Set de Piston Pistón Set поршневой	RINGS SET Kolben Set Segments de Piston Anillos Set кольца	PIN Pin Axe Perno Пин
<b>AMF</b>  <b>3 Cyl</b> <b>79.5 mm Bore Ø</b> <b>1,422 cc</b>		Length: 152.0 Outside Ø: 82.5 Flange Ø: 85.5 flange depth 4.7	STD	O/S	alfin top ring land and skirt MOS2 treated pin bushing inserted fits tapered con. rod	Top: 1.75	Ø: 26.0  Length: 63.0
			Length: 69.8	69.8		2nd: 2.0	
			Comp: 45.8	45.5		3rd: 3.0	
			Height: -8.7	-8.7		1st oil: 3.0	
			-17.6	-17.6		2nd oil:	
			Reference no.:		Reference no.:	Reference no.:	O-RING
			<b>A-SU351317 G-1402795000 K-89434190 M-029WV20</b>		<b>M-0305400</b>	<b>A-R60370 G-0811490000 K-800000810000 K-800051640000 M-03020N0</b>	
NM-Germany Article no. Artikelnummer/ Modelo Número / статья НОМЕР	NM-Germany Article no.	NM-Germany Article no.	NM-Germany Article no.	NM-Germany Article no.	NM-Germany Article no.	NM-Germany Article no.	NM-Germany Article no.
	<b>LBSSK30768DSA</b> (for cyl 1/2)	<b>LBSK30768DSA</b>	<b>KBSSK30768DA</b> (for cyl 1/2)	<b>KBSK30768DA</b> (for cyl 1/2)	<b>KRSK30768DA</b>		







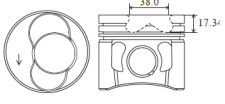

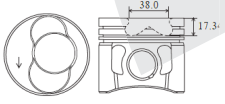

**DIESEL**

ENGINE TYPE Motortyp Type de Moteur Tipo de motor Тип двигателя	LINER KIT Liner Kit Kit de Chemise Camisas de los cilindros лайнер комплект	CYL. LINER Zylinderlaufbuchse Chemise Camisas de los cilindros втулка цилиндра	PISTON + RINGS Kolben + Ringe Piston + Segments Pistón Set Поршень и кольца		PISTON SET Kolben Set Set de Piston Pistón Set поршневой	RINGS SET Kolben Set Segments de Piston Anillos Set кольца	PIN Pin Axe Perno Пин				
<b>BJB</b> <b>BLS</b> <b>BXE</b> 4 Cyl 79.5 mm Bore Ø 1,896 cc 		Length: Outside Ø: Flange Ø: flange depth	STD	0.50	alfin pin bushing inserted fits tapered con. rod	Top:	1.75	Ø: 26.0 Length: 66.0			
			0.25	1.00		Length:	69.55		69.55	2nd:	2.0
			Comp:	45.8		45.55	3rd:		3.0	1st oil:	3.0
			Height:	-17.34	-17.34	2nd oil:					
			Reference no.:	Reference no.:	Reference no.:	Reference no.:	O-RING				
				<b>K-40421600</b>		<b>A-R60370</b> <b>G-0811490000</b> <b>K-800000810000</b> <b>K-800051640000</b> <b>M-03020N0</b>					
NM-Germany Article no. Artikelnummer/ Modelo Número / статья НОМЕР	NM-Germany Article no.	NM-Germany Article no.	NM-Germany Article no.	NM-Germany Article no.	NM-Germany Article no.	NM-Germany Article no.	NM-Germany Article no.				
			<b>KBSSK40772DA</b>	<b>KBSK40772DA</b>	<b>KRSK40772DA</b>						

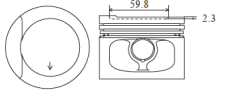

**DIESEL**

ENGINE TYPE Motortyp Type de Moteur Tipo de motor Тип двигателя	LINER KIT Liner Kit Kit de Chemise Camisas de los cilindros лайнер комплект	CYL. LINER Zylinderlaufbuchse Chemise Camisas de los cilindros втулка цилиндра	PISTON + RINGS Kolben + Ringe Piston + Segments Pistón Set Поршень и кольца		PISTON SET Kolben Set Set de Piston Pistón Set поршневой	RINGS SET Kolben Set Segments de Piston Anillos Set кольца	PIN Pin Axe Perno Пин				
<b>BJB</b> <b>BLS</b> <b>BXE</b> 4 Cyl 79.5 mm Bore Ø 1,896 cc 		Length: Outside Ø: Flange Ø: flange depth	STD	0.50	alfin pin bushing inserted fits tapered con. rod	Top:	1.75	Ø: 26.0 Length: 66.0			
			0.25	1.00		Length:	69.8		69.55	2nd:	2.0
			Comp:	45.8		45.55	3rd:		3.0	1st oil:	3.0
			Height:	-17.34	-17.34	2nd oil:					
			Reference no.:	Reference no.:	Reference no.:	Reference no.:	O-RING				
				<b>K-40422600</b>		<b>A-R60370</b> <b>G-0811490000</b> <b>K-800000810000</b> <b>K-800051640000</b> <b>M-03020N0</b>					
NM-Germany Article no. Artikelnummer/ Modelo Número / статья НОМЕР	NM-Germany Article no.	NM-Germany Article no.	NM-Germany Article no.	NM-Germany Article no.	NM-Germany Article no.	NM-Germany Article no.	NM-Germany Article no.				
			<b>KBSSK40773DA</b>	<b>KBSK40773DA</b>	<b>KRSK40773DA</b>						

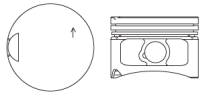

**GASOLINE**

ENGINE TYPE Motortyp Type de Moteur Tipo de motor Тип двигателя	LINER KIT Liner Kit Kit de Chemise Camisas de los cilindros лайнер комплект	CYL. LINER Zylinderlaufbuchse Chemise Camisas de los cilindros втулка цилиндра	PISTON + RINGS Kolben + Ringe Piston + Segments Pistón Set Поршень и кольца		PISTON SET Kolben Set Set de Piston Pistón Set поршневой	RINGS SET Kolben Set Segments de Piston Anillos Set кольца	PIN Pin Axe Perno Пин				
<b>1F</b> 4 Cyl 81.0 mm Bore Ø 1,595 cc 		Length: Outside Ø: Flange Ø: flange depth	STD	O/S		Top:	1.5	Ø: 20.0 Length: 57.0			
			66.8	66.5		Length:	66.8		66.5	2nd:	1.75
			Comp:	35.6		35.3	3rd:		3.0	1st oil:	3.0
			Height:	+2.2	+2.2	2nd oil:					
			-2.3	-2.3							
			Reference no.:	Reference no.:	Reference no.:	Reference no.:	O-RING				
				<b>K-93872600</b> <b>M-0347600</b>		<b>A-R60300</b> <b>G-0850190000</b> <b>K-800001011000</b> <b>M-03475N0</b>					
NM-Germany Article no. Artikelnummer/ Modelo Número / статья НОМЕР	NM-Germany Article no.	NM-Germany Article no.	NM-Germany Article no.	NM-Germany Article no.	NM-Germany Article no.	NM-Germany Article no.	NM-Germany Article no.				
			<b>KBSSK40774G</b>	<b>KBSK40774G</b>	<b>KRSK40774G</b>						

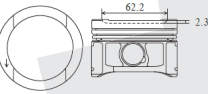

**GASOLINE**

ENGINE TYPE Motortyp Type de Moteur Tipo de motor Тип двигателя	LINER KIT Liner Kit Kit de Chemise Camisas de los cilindros лайнер комплект	CYL. LINER Zylinderlaufbuchse Chemise Camisas de los cilindros втулка цилиндра	PISTON + RINGS Kolben + Ringe Piston + Segments Pistón Set Поршень и кольца		PISTON SET Kolben Set Set de Piston Pistón Set поршневой		RINGS SET Kolben Set Segments de Piston Anillos Set кольца	PIN Pin Axe Perno Пин	
<b>ADR AGN</b> 4 Cyl 81.0 mm Bore Ø 1,781 cc  				STD	O/S	skirt MOS2 treated	Top:	1.5	Ø: 20.0 Length: 59.0
			Length:	56.8	56.5		2nd:	1.75	
			Outside Ø:	32.6	32.3		3rd:	2.0	
			Flange Ø:	-2.5	-2.5		1st oil:	2.0	
			flange depth				2nd oil:		
			Reference no.:	Reference no.:	Reference no.:	Reference no.:	O-RING		
				K-99559600 M-0331300 N-8750290000			A-R60320 G-0850290000 K-800045040000 M-03304N0 T-50017		
NM-Germany Article no. Artikelnummer/ Modelo Número / статья НОМЕР	NM-Germany Article no.	NM-Germany Article no.	NM-Germany Article no.	NM-Germany Article no.	NM-Germany Article no.	NM-Germany Article no.	NM-Germany Article no.	NM-Germany Article no.	
			KBSSK40775G	KBSK40775G		KRSK40775G			

**GASOLINE**

ENGINE TYPE Motortyp Type de Moteur Tipo de motor Тип двигателя	LINER KIT Liner Kit Kit de Chemise Camisas de los cilindros лайнер комплект	CYL. LINER Zylinderlaufbuchse Chemise Camisas de los cilindros втулка цилиндра	PISTON + RINGS Kolben + Ringe Piston + Segments Pistón Set Поршень и кольца		PISTON SET Kolben Set Set de Piston Pistón Set поршневой		RINGS SET Kolben Set Segments de Piston Anillos Set кольца	PIN Pin Axe Perno Пин	
<b>ADP/AEH AHL/AKL</b> 4 Cyl 81.0 mm Bore Ø 1,595 cc  				STD	O/S	skirt MOS2 treated	Top:	1.2	Ø: 20.0 Length: 57.0
			Length:	53.8	53.5		2nd:	1.5	
			Outside Ø:	32.0	31.7		3rd:	2.0	
			Flange Ø:	+0.7	+0.7		1st oil:	2.0	
			flange depth	-2.3	-2.3		2nd oil:		
			Reference no.:	Reference no.:	Reference no.:	Reference no.:	O-RING		
				K-94503700 M-0330100 N-8710590000			A-R60290 G-0810590000 K-8000039440000 M-03301N0		
NM-Germany Article no. Artikelnummer/ Modelo Número / статья НОМЕР	NM-Germany Article no.	NM-Germany Article no.	NM-Germany Article no.	NM-Germany Article no.	NM-Germany Article no.	NM-Germany Article no.	NM-Germany Article no.	NM-Germany Article no.	
			KBSSK40776G	KBSK40776G		KRSK40776G			

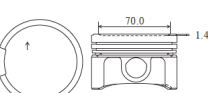
**GASOLINE**

ENGINE TYPE Motortyp Type de Moteur Tipo de motor Тип двигателя	LINER KIT Liner Kit Kit de Chemise Camisas de los cilindros лайнер комплект	CYL. LINER Zylinderlaufbuchse Chemise Camisas de los cilindros втулка цилиндра	PISTON + RINGS Kolben + Ringe Piston + Segments Pistón Set Поршень и кольца		PISTON SET Kolben Set Set de Piston Pistón Set поршневой		RINGS SET Kolben Set Segments de Piston Anillos Set кольца	PIN Pin Axe Perno Пин	
<b>AEB AGU ARZ</b> 4 Cyl 81.0 mm Bore Ø 1,781 cc  				STD	O/S	skirt MOS2 treated	Top:	1.5	Ø: 20.0 Length: 59.0
			Length:	53.7	53.4		2nd:	1.75	
			Outside Ø:	32.7	32.4		3rd:	2.0	
			Flange Ø:	-1.4	-1.4		1st oil:	2.0	
			flange depth				2nd oil:		
			Reference no.:	Reference no.:	Reference no.:	Reference no.:	O-RING		
				K-99933600 M-0330400 N-8750290010			A-R60320 G-0850290000 K-800045040000 M-03304N0 T-50017		
NM-Germany Article no. Artikelnummer/ Modelo Número / статья НОМЕР	NM-Germany Article no.	NM-Germany Article no.	NM-Germany Article no.	NM-Germany Article no.	NM-Germany Article no.	NM-Germany Article no.	NM-Germany Article no.	NM-Germany Article no.	
			KBSSK40777G	KBSK40777G		KRSK40777G			

## GASOLINE

ENGINE TYPE	LINER KIT	CYL. LINER	PISTON + RINGS			PISTON SET	RINGS SET	PIN	
Motortyp Type de Moteur Tipo de motor Тип двигателя	Liner Kit Kit de Chemise Camisas de los cilindros лайнер комплект	Zylinderlaufbuchse Chemise Camisas de los cilindros втулка цилиндра	Kolben + Ringe Piston + Segments Pistón Set Поршень и кольца			Kolben Set Set de Piston Pistón Set поршневой	Kolben Set Segments de Piston Anillos Set кольца	Pin Axe Perno Пин	
<b>ARX/AUM TURBO</b> <b>AUQ/AWT TURBO</b>  4 Cyl 81.0 mm Bore Ø 1,781 cc		Length: Outside Ø: Flange Ø: flange depth	Length:	STD 0.25	0.50	top and 2nd ring lands anodized skirt MOS2 treated fits tapered con. rod	Top:	1.5	Ø: 19.0  Length: 50.0
			Comp:	53.7	53.4		2nd:	1.75	
			Height:	32.7	32.4		3rd:	2.0	
			Height:	-1.9	-1.9		1st oil:		
							2nd oil:		
			Reference no.:	Reference no.:	Reference no.:	Reference no.:	O-RING		
				<b>K-40434600</b> <b>M-0331600</b>			<b>A-R60320</b> <b>G-0850290000</b> <b>K-800045040000</b> <b>M-03304N0</b> <b>T-50017</b>		
NM-Germany Article no. Artikelnummer/ Modelo Número / статья НОМЕР	NM-Germany Article no.	NM-Germany Article no.	NM-Germany Article no.	NM-Germany Article no.	NM-Germany Article no.	NM-Germany Article no.	NM-Germany Article no.	NM-Germany Article no.	
			<b>KBSSK40778G</b>	<b>KBSK40778G</b>	<b>KRSK40778G</b>				

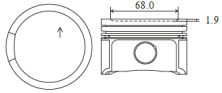

## GASOLINE

ENGINE TYPE	LINER KIT	CYL. LINER	PISTON + RINGS			PISTON SET	RINGS SET	PIN	
Motortyp Type de Moteur Tipo de motor Тип двигателя	Liner Kit Kit de Chemise Camisas de los cilindros лайнер комплект	Zylinderlaufbuchse Chemise Camisas de los cilindros втулка цилиндра	Kolben + Ringe Piston + Segments Pistón Set Поршень и кольца			Kolben Set Set de Piston Pistón Set поршневой	Kolben Set Segments de Piston Anillos Set кольца	Pin Axe Perno Пин	
<b>AVU/BFQ/BGU</b> <b>BSE/BSF</b>  4 Cyl 81.0 mm Bore Ø 1,595 cc		Length: Outside Ø: Flange Ø: flange depth	Length:	STD 50.8	O/S 50.45	skirt MOS2 treated fits tapered con. rod	Top:	1.0	Ø: 19.0  Length: 42.0
			Comp:	29.7	29.45		2nd:	1.2	
			Height:	-2.7	-2.7		3rd:	2.0	
			Height:				1st oil:		
							2nd oil:		
			Reference no.:	Reference no.:	Reference no.:	Reference no.:	O-RING		
				<b>K-99792600</b> <b>M-0332000</b>			<b>G-0814830000</b> <b>K-800049841050</b> <b>M-03077N0</b>		
NM-Germany Article no. Artikelnummer/ Modelo Número / статья НОМЕР	NM-Germany Article no.	NM-Germany Article no.	NM-Germany Article no.	NM-Germany Article no.	NM-Germany Article no.	NM-Germany Article no.	NM-Germany Article no.	NM-Germany Article no.	
			<b>KBSSK40779G</b>	<b>KBSK40779G</b>	<b>KRSK40779G</b>				

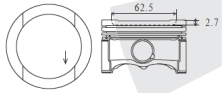

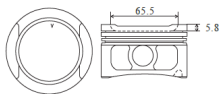

## GASOLINE

ENGINE TYPE	LINER KIT	CYL. LINER	PISTON + RINGS			PISTON SET	RINGS SET	PIN	
Motortyp Type de Moteur Tipo de motor Тип двигателя	Liner Kit Kit de Chemise Camisas de los cilindros лайнер комплект	Zylinderlaufbuchse Chemise Camisas de los cilindros втулка цилиндра	Kolben + Ringe Piston + Segments Pistón Set Поршень и кольца			Kolben Set Set de Piston Pistón Set поршневой	Kolben Set Segments de Piston Anillos Set кольца	Pin Axe Perno Пин	
<b>AEG/APK/AQY</b> <b>AZL/CFEA</b>  4 Cyl 82.5 mm Bore Ø 1,984 cc		Length: Outside Ø: Flange Ø: flange depth	Length:	STD 50.8	O/S 50.5		Top:	1.2	Ø: 20.0  Length: 52.0
			Comp:	29.3	29.0		2nd:	1.5	
			Height:	+0.7	+0.7		3rd:	2.0	
			Height:	-5.8	-5.8		1st oil:		
							2nd oil:		
			Reference no.:	Reference no.:	Reference no.:	Reference no.:	O-RING		
				<b>K-99870600</b> <b>M-0306000</b>			<b>A-R60310</b> <b>G-0850180000</b> <b>K-800001220000</b> <b>K-800045720000</b> <b>M-03031N0</b> <b>M-03060N0</b> <b>M-03075N0</b> <b>M-03319N0</b> <b>T-50018</b> <b>T-50025</b>		
NM-Germany Article no. Artikelnummer/ Modelo Número / статья НОМЕР	NM-Germany Article no.	NM-Germany Article no.	NM-Germany Article no.	NM-Germany Article no.	NM-Germany Article no.	NM-Germany Article no.	NM-Germany Article no.	NM-Germany Article no.	
			<b>KBSSK40780G</b>	<b>KBSK40780G</b>	<b>KRSK40780G</b>				

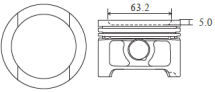

## GASOLINE

ENGINE TYPE Motortyp Type de Moteur Tipo de motor Тип двигателя	LINER KIT Liner Kit Kit de Chemise Camisas de los cilindros лайнер комплект	CYL. LINER Zylinderlaufbuchse Chemise Camisas de los cilindros втулка цилиндра	PISTON + RINGS Kolben + Ringe Piston + Segments Pistón Set Поршень и кольца	PISTON SET Kolben Set Set de Piston Pistón Set поршневой	RINGS SET Kolben Set Segments de Piston Anillos Set кольца	PIN Pin Axe Perno Пин
<b>AZL/AZM</b>  <b>4 Cyl</b> <b>82.5 mm Bore Ø</b> <b>1,984 cc</b>  		Length: Outside Ø: Flange Ø: flange depth	Length: 51.0 Comp: 29.3 Height: -5.0		Top: 1.2 2nd: 1.5 3rd: 1st oil: 2.0 2nd oil:	Ø: 19.0 Length: 42.0
		<b>Reference no.:</b>	<b>Reference no.:</b>	<b>Reference no.:</b>	<b>Reference no.:</b>	<b>O-RING</b>
			<b>M-0309200</b>	<b>06B 107 065 B</b> <b>06B 107 065 Q</b> <b>06B 107 103 B</b>	<b>A-R60310</b> <b>G-0850180000</b> <b>K-800001220000</b> <b>K-800045720000</b> <b>M-03031N0</b> <b>M-03060N0</b> <b>M-03075N0</b> <b>M-03319N0</b> <b>T-50018</b> <b>T-50025</b>	
NM-Germany Article no. Artikelnummer/ Modelo Número / статья НОМЕР	NM-Germany Article no.	NM-Germany Article no.	NM-Germany Article no.	NM-Germany Article no.	NM-Germany Article no.	NM-Germany Article no.
			<b>KBSSK40781G</b>	<b>KBSK40781G</b>	<b>KRSK40781G</b>	







**DIESEL**



ENGINE TYPE Motortyp Type de Moteur Tipo de motor Тип двигателя	LINER KIT Liner Kit Kit de Chemise Camisas de los cilindros лайнер комплект	CYL. LINER Zylinderlaufbuchse Chemise Camisas de los cilindros втулка цилиндра	PISTON + RINGS Kolben + Ringe Piston + Segments Pistón Set Поршень и кольца			PISTON SET Kolben Set Set de Piston Pistón Set поршневой	RINGS SET Kolben Set Segments de Piston Anillos Set кольца	PIN Pin Axe Perno Пин
<b>HR TURBO</b> 4 Cyl 92.0 mm Bore Ø 2,499 cc	<b>A-ASA2460</b> <b>K-92286961</b> <b>K-92286971</b> <b>M-4891390</b> <b>N-8911010000</b>	Length: 168.0 Outside Ø: 103.0 Flange Ø: 110.0 flange depth 8.9 +1.2	Length: 86.1 Comp: 51.1 Height: -2.3 -3.9		alfin head and top ring land anodized	Top: 2.5 double key- stone 2nd: 2.0 3rd: 2.0 1st oil: 4.0 2nd oil:	Ø: 30.0 Length: 75.5	
		Reference no.:	Reference no.:	Reference no.:	Reference no.:	O-RING		
		<b>A-SJ351453</b> <b>G-1467642000</b> <b>K-89500110</b> <b>M-489WN01</b>	<b>K-92286600</b> <b>K-92286700</b> <b>M-4891300</b>		<b>A-R47730</b> <b>G-0811010000</b> <b>K-800000110000</b> <b>M-48912N0</b>	<b>ORVM40797DA</b>		
NM-Germany Article no. Artikelnummer/ Modelo Número / статья НОМЕР	NM-Germany Article no.	NM-Germany Article no.	NM-Germany Article no.	NM-Germany Article no.	NM-Germany Article no.	NM-Germany Article no.	NM-Germany Article no.	
	LBSVM40797DFA	LBVM40797DFA	KBSVM40797DA	KBVM40797DA	KRVM40797DA			

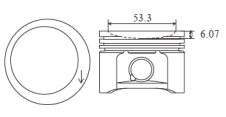

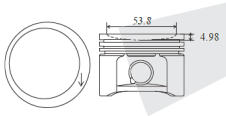

**GASOLINE**

ENGINE TYPE Motortyp Type de Moteur Tipo de motor Тип двигателя	LINER KIT Liner Kit Kit de Chemise Camisas de los cilindros лайнер комплект	CYL. LINER Zylinderlaufbuchse Chemise Camisas de los cilindros втулка цилиндра	PISTON + RINGS Kolben + Ringe Piston + Segments Pistón Set Поршень и кольца			PISTON SET Kolben Set Set de Piston Pistón Set поршневой	RINGS SET Kolben Set Segments de Piston Anillos Set кольца	PIN Pin Axe Perno Пин
<b>AFZ</b> 4 Cyl 67.1 mm Bore Ø 999 cc 		Length:		Length:	49.77	Top:	1.2	Ø: 17.0 Length: 45.0
		Outside Ø:		Comp:	31.27	2nd:	1.5	
		Flange Ø:		Height:	-6.07	3rd:	2.0	
		flange depth				1st oil:	2.0	
			<b>Reference no.:</b>	<b>Reference no.:</b>	<b>Reference no.:</b>	<b>Reference no.:</b>	<b>O-RING</b>	
				<b>M-S70500</b>	<b>M-E70500</b>	<b>036 198 151 J HT-2C4808 M-A70500</b>		
NM-Germany Article no. Artikelnummer/ Modelo Número / статья НОМЕР	NM-Germany Article no.	NM-Germany Article no.	NM-Germany Article no.	NM-Germany Article no.	NM-Germany Article no.	NM-Germany Article no.	NM-Germany Article no.	NM-Germany Article no.
			<b>KBSVW40798G</b>	<b>KBVW40798G</b>	<b>KRVW40798G</b>			

**GASOLINE**

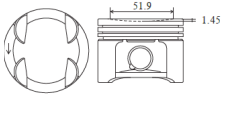

ENGINE TYPE Motortyp Type de Moteur Tipo de motor Тип двигателя	LINER KIT Liner Kit Kit de Chemise Camisas de los cilindros лайнер комплект	CYL. LINER Zylinderlaufbuchse Chemise Camisas de los cilindros втулка цилиндра	PISTON + RINGS Kolben + Ringe Piston + Segments Pistón Set Поршень и кольца			PISTON SET Kolben Set Set de Piston Pistón Set поршневой	RINGS SET Kolben Set Segments de Piston Anillos Set кольца	PIN Pin Axe Perno Пин
<b>1.0L AT 8V</b> 4 Cyl 67.1 mm Bore Ø 999 cc 		Length:		Length:	49.77	Top:	1.2	Ø: 17.0 Length: 45.0
		Outside Ø:		Comp:	31.27	2nd:	1.5	
		Flange Ø:		Height:	-4.98	3rd:	2.0	
		flange depth				1st oil:	2.0	
			<b>Reference no.:</b>	<b>Reference no.:</b>	<b>Reference no.:</b>	<b>Reference no.:</b>	<b>O-RING</b>	
				<b>M-S70505</b>	<b>M-E70505</b>	<b>036 198 151 J HT-2C4808 M-A70500</b>		
NM-Germany Article no. Artikelnummer/ Modelo Número / статья НОМЕР	NM-Germany Article no.	NM-Germany Article no.	NM-Germany Article no.	NM-Germany Article no.	NM-Germany Article no.	NM-Germany Article no.	NM-Germany Article no.	NM-Germany Article no.
			<b>KBSVW40799G</b>	<b>KBVW40799G</b>	<b>KRVW40799G</b>			

**GASOLINE**

ENGINE TYPE Motortyp Type de Moteur Tipo de motor Тип двигателя	LINER KIT Liner Kit Kit de Chemise Camisas de los cilindros лайнер комплект	CYL. LINER Zylinderlaufbuchse Chemise Camisas de los cilindros втулка цилиндра	PISTON + RINGS Kolben + Ringe Piston + Segments Pistón Set Поршень и кольца			PISTON SET Kolben Set Set de Piston Pistón Set поршневой	RINGS SET Kolben Set Segments de Piston Anillos Set кольца	PIN Pin Axe Perno Пин
<b>ASW AZP</b> 4 Cyl 67.1 mm Bore Ø 999 cc 		Length:		Length:	49.77	Top:	1.2	Ø: 17.0 Length: 45.0
		Outside Ø:		Comp:	31.27	2nd:	1.5	
		Flange Ø:		Height:	-1.45	3rd:	2.0	
		flange depth				1st oil:	2.0	
			<b>Reference no.:</b>	<b>Reference no.:</b>	<b>Reference no.:</b>	<b>Reference no.:</b>	<b>O-RING</b>	
				<b>M-S70550</b>	<b>036 198 101 I M-E70550</b>	<b>036 198 151 J HT-2C4808 M-A70500</b>		
NM-Germany Article no. Artikelnummer/ Modelo Número / статья НОМЕР	NM-Germany Article no.	NM-Germany Article no.	NM-Germany Article no.	NM-Germany Article no.	NM-Germany Article no.	NM-Germany Article no.	NM-Germany Article no.	NM-Germany Article no.
			<b>KBSVW40800G</b>	<b>KBVW40800G</b>	<b>KRVW40800G</b>			



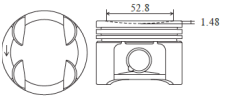

**GASOLINE**

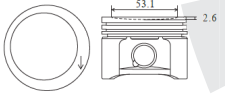

ENGINE TYPE Motortyp Type de Moteur Tipo de motor Тип двигателя	LINER KIT Liner Kit Kit de Chemise Camisas de los cilindros лайнер комплект	CYL. LINER Zylinderlaufbuchse Chemise Camisas de los cilindros втулка цилиндра	PISTON + RINGS Kolben + Ringe Piston + Segments Pistón Set Поршень и кольца		PISTON SET Kolben Set Set de Piston Pistón Set поршневой	RINGS SET Kolben Set Segments de Piston Anillos Set кольца	PIN Pin Axe Perno Пин
<b>1.0L AT 16V</b>			Length:	49.77		Top: 1.2	Ø: 17.0 Length: 45.0
<b>4 Cyl</b>			Outside Ø:	Comp: 31.27		2nd: 1.5	
<b>67.1 mm Bore Ø</b>			Flange Ø:	Height: -1.48		3rd: 2.0	
<b>999 cc</b>			flange depth			1st oil: 2.0	
			Reference no.:	Reference no.:	Reference no.:	Reference no.:	O-RING
				<b>M-S70555</b>	<b>M-E70555</b>	<b>036 198 151 J</b> <b>HT-2C4808</b> <b>M-A70500</b>	
NM-Germany Article no. Artikelnummer/ Modelo Número / статья НОМЕР	NM-Germany Article no.	NM-Germany Article no.	NM-Germany Article no.	NM-Germany Article no.	NM-Germany Article no.	NM-Germany Article no.	NM-Germany Article no.
			<b>KBSVW40801G</b>	<b>KBVW40801G</b>	<b>KRVW40801G</b>		

VW

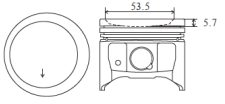

**GASOLINE**

ENGINE TYPE Motortyp Type de Moteur Tipo de motor Тип двигателя	LINER KIT Liner Kit Kit de Chemise Camisas de los cilindros лайнер комплект	CYL. LINER Zylinderlaufbuchse Chemise Camisas de los cilindros втулка цилиндра	PISTON + RINGS Kolben + Ringe Piston + Segments Pistón Set Поршень и кольца		PISTON SET Kolben Set Set de Piston Pistón Set поршневой	RINGS SET Kolben Set Segments de Piston Anillos Set кольца	PIN Pin Axe Perno Пин
<b>AQZ</b>			Length:	49.77		Top: 1.2	Ø: 17.0 Length: 45.0
<b>4 Cyl</b>			Outside Ø:	Comp: 31.27		2nd: 1.5	
<b>67.1 mm Bore Ø</b>			Flange Ø:	Height: -2.6		3rd: 2.0	
<b>999 cc</b>			flange depth			1st oil: 2.0	
			Reference no.:	Reference no.:	Reference no.:	Reference no.:	O-RING
				<b>M-S70510</b>	<b>030 107 099 A</b> <b>030 107 099 J</b> <b>M-E70510</b>	<b>036 198 151 J</b> <b>HT-2C4808</b> <b>M-A70500</b>	
NM-Germany Article no. Artikelnummer/ Modelo Número / статья НОМЕР	NM-Germany Article no.	NM-Germany Article no.	NM-Germany Article no.	NM-Germany Article no.	NM-Germany Article no.	NM-Germany Article no.	NM-Germany Article no.
			<b>KBSVW40802G</b>	<b>KBVW40802G</b>	<b>KRVW40802G</b>		

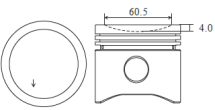

**GASOLINE**

ENGINE TYPE Motortyp Type de Moteur Tipo de motor Тип двигателя	LINER KIT Liner Kit Kit de Chemise Camisas de los cilindros лайнер комплект	CYL. LINER Zylinderlaufbuchse Chemise Camisas de los cilindros втулка цилиндра	PISTON + RINGS Kolben + Ringe Piston + Segments Pistón Set Поршень и кольца		PISTON SET Kolben Set Set de Piston Pistón Set поршневой	RINGS SET Kolben Set Segments de Piston Anillos Set кольца	PIN Pin Axe Perno Пин
<b>AER</b>			Length:	56.3	STD	Top: 1.0	Ø: 17.0 Length: 45.0
<b>ALL</b>			Outside Ø:	Comp: 31.3	O/S	2nd: 1.2	
<b>4 Cyl</b>			Flange Ø:	Height: -5.7	-5.7	3rd: 2.0	
<b>67.1 mm Bore Ø</b>			flange depth			1st oil: 2.0	
<b>999 cc</b>			Reference no.:	Reference no.:	Reference no.:	Reference no.:	O-RING
				<b>K-99679600</b> <b>M-0305200</b> <b>N-8710130000</b>		<b>A-R66690</b> <b>G-0810130000</b> <b>K-800053740000</b> <b>M-03052N0</b>	
NM-Germany Article no. Artikelnummer/ Modelo Número / статья НОМЕР	NM-Germany Article no.	NM-Germany Article no.	NM-Germany Article no.	NM-Germany Article no.	NM-Germany Article no.	NM-Germany Article no.	NM-Germany Article no.
			<b>KBSVW40803G</b>	<b>KBVW40803G</b>	<b>KRVW40803G</b>		

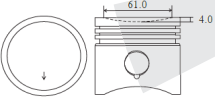

**GASOLINE**

ENGINE TYPE Motortyp Type de Moteur Tipo de motor Тип двигателя	LINER KIT Liner Kit Kit de Chemise Camisas de los cilindros лайнер комплект	CYL. LINER Zylinderlaufbuchse Chemise Camisas de los cilindros втулка цилиндра	PISTON + RINGS Kolben + Ringe Piston + Segments Pistón Set Поршень и кольца		PISTON SET Kolben Set Set de Piston Pistón Set поршень	RINGS SET Kolben Set Segments de Piston Anillos Set кольца	PIN Pin Axe Perno Пин	
<b>GG FA</b> 4 Cyl 69.5 mm Bore Ø 1,093 cc  		Length:		Length:	66.9	Top:	1.75	Ø: 20.0 Length: 57.8
		Outside Ø:		Comp:	40.2	2nd:	2.0	
		Flange Ø:		Height:	-4.0	3rd:		
		flange depth				2nd oil:		
		Reference no.:		Reference no.:		Reference no.:		O-RING
						<b>G-0810870000 K-800000240000 M-02943N0</b>		
NM-Germany Article no. Artikelnummer/ Modelo Número / статья НОМЕР	NM-Germany Article no.	NM-Germany Article no.	NM-Germany Article no.	NM-Germany Article no.	NM-Germany Article no.	NM-Germany Article no.	NM-Germany Article no.	NM-Germany Article no.
			KBSVW40804G	KBVW40804G	KRVW40804G			

**GASOLINE**

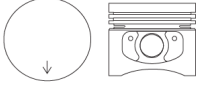

ENGINE TYPE Motortyp Type de Moteur Tipo de motor Тип двигателя	LINER KIT Liner Kit Kit de Chemise Camisas de los cilindros лайнер комплект	CYL. LINER Zylinderlaufbuchse Chemise Camisas de los cilindros втулка цилиндра	PISTON + RINGS Kolben + Ringe Piston + Segments Pistón Set Поршень и кольца		PISTON SET Kolben Set Set de Piston Pistón Set поршень	RINGS SET Kolben Set Segments de Piston Anillos Set кольца	PIN Pin Axe Perno Пин	
<b>FA/FJ GG/HB/HD</b> 4 Cyl 69.5 mm Bore Ø 1,093 cc  		Length:		Length:	STD 67.2 O/S 66.95	Top:	1.75	Ø: 20.0 Length: 58.0
		Outside Ø:		Comp:	40.2 39.95	2nd:	2.0	
		Flange Ø:		Height:	-4.0 -4.0	3rd:		
		flange depth				2nd oil:		
		Reference no.:		Reference no.:		Reference no.:		O-RING
				<b>K-93159600 M-0294400 N-8710870000</b>		<b>G-0810870000 K-800000240000 M-02943N0</b>		
NM-Germany Article no. Artikelnummer/ Modelo Número / статья НОМЕР	NM-Germany Article no.	NM-Germany Article no.	NM-Germany Article no.	NM-Germany Article no.	NM-Germany Article no.	NM-Germany Article no.	NM-Germany Article no.	NM-Germany Article no.
			KBSVW40805G	KBVW40805G	KRVW40805G			

**GASOLINE**



ENGINE TYPE Motortyp Type de Moteur Tipo de motor Тип двигателя	LINER KIT Liner Kit Kit de Chemise Camisas de los cilindros лайнер комплект	CYL. LINER Zylinderlaufbuchse Chemise Camisas de los cilindros втулка цилиндра	PISTON + RINGS Kolben + Ringe Piston + Segments Pistón Set Поршень и кольца		PISTON SET Kolben Set Set de Piston Pistón Set поршень	RINGS SET Kolben Set Segments de Piston Anillos Set кольца	PIN Pin Axe Perno Пин	
<b>FY/FZ GF/GS GT/HH/HJ</b> 4 Cyl 75.0 mm Bore Ø 1,272 cc  	<b>M-0294890</b>	Length:	133.0	Length:	65.6 65.3	Top:	1.75	Ø: 20.0 Length: 63.0
		Outside Ø:	81.0	Comp:	38.6 38.3	2nd:	2.0	
		Flange Ø:		Height:	+0 +0	3rd:		
		flange depth	4.5			2nd oil:		
		Reference no.:		Reference no.:		Reference no.:		O-RING
				<b>M-029WV19</b>	<b>K-93084600 M-0294800</b>	<b>G-0840420000 K-800000440000 M-02948N0</b>		
NM-Germany Article no. Artikelnummer/ Modelo Número / статья НОМЕР	NM-Germany Article no.	NM-Germany Article no.	NM-Germany Article no.	NM-Germany Article no.	NM-Germany Article no.	NM-Germany Article no.	NM-Germany Article no.	NM-Germany Article no.
	LBSVW40806GS	LBVW40806GS	KBSVW40806G	KBVW40806G	KRVW40806G			

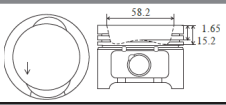

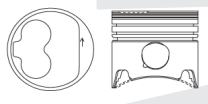

**GASOLINE**

ENGINE TYPE	LINER KIT	CYL. LINER	PISTON + RINGS		PISTON SET	RINGS SET	PIN
Motortyp Type de Moteur Tipo de motor Тип двигателя	Liner Kit Kit de Chemise Camisas de los cilindros лайнер комплект	Zylinderlaufbuchse Chemise Camisas de los cilindros втулка цилиндра	Kolben + Ringe Piston + Segments Pistón Set Поршень и кольца		Kolben Set Set de Piston Pistón Set поршневой	Kolben Set Segments de Piston Anillos Set кольца	Pin Axe Perno Пин
<b>ABD</b> <b>4 Cyl</b> <b>75.0 mm Bore Ø</b> <b>1,391 cc</b>			STD	O/S		Top: 1.5 2nd: 1.5 3rd: 1.5 1st oil: 2.5 2nd oil:	Ø: 17.0 Length: 48.0
		Length: 52.0 Outside Ø: 34.5 Flange Ø: -1.65 flange depth	51.75 34.25 -1.65 -15.2				
			Reference no.:	Reference no.:	Reference no.:	Reference no.:	O-RING
			<b>K-92228600</b> <b>M-0299800</b>			<b>G-0850220000</b> <b>K-800024940000</b> <b>M-02992N0</b>	
NM-Germany Article no. Artikelnummer/ Modelo Número / статья НОМЕР	NM-Germany Article no.	NM-Germany Article no.	NM-Germany Article no.	NM-Germany Article no.	NM-Germany Article no.	NM-Germany Article no.	NM-Germany Article no.
			<b>KBSVW40810G</b>	<b>KBVW40810G</b>	<b>KRVW40810G</b>		

**DIESEL**

ENGINE TYPE	LINER KIT	CYL. LINER	PISTON + RINGS		PISTON SET	RINGS SET	PIN
Motortyp Type de Moteur Tipo de motor Тип двигателя	Liner Kit Kit de Chemise Camisas de los cilindros лайнер комплект	Zylinderlaufbuchse Chemise Camisas de los cilindros втулка цилиндра	Kolben + Ringe Piston + Segments Pistón Set Поршень и кольца		Kolben Set Set de Piston Pistón Set поршневой	Kolben Set Segments de Piston Anillos Set кольца	Pin Axe Perno Пин
<b>1G/1V/CY TURBO</b> <b>DV/MF/JR TURBO</b> <b>JX/RA/SB TURBO</b> <b>4/6 Cyl</b> <b>76.5 mm Bore Ø</b> <b>1,588 cc 2,383 cc</b>	<b>068 103 101</b> <b>D K-90732960</b> <b>M-0297990</b>		STD	O/S	alfin head anodized fits tapered con. rod	Top: 1.75 2nd: 2.0 3rd: 3.0 1st oil: 2nd oil:	Ø: 24.0 Length: 64.0
		Length: 145.0 Outside Ø: 79.5 Flange Ø: 81.5 flange depth 4.7	Length: 71.7 Comp: 41.7 Height: -1.6	71.45 41.45 -1.6			
			Reference no.:	Reference no.:	Reference no.:	Reference no.:	O-RING
			<b>G-140283600</b> <b>K-89163190</b> <b>M-029WV13</b>	<b>K-90732600</b> <b>M-0297900</b> <b>N-8710980010</b>	<b>068 107 065 AT</b> <b>068 107 065 BC</b> <b>068 107 065 BD</b> <b>068 107 065 BE</b> <b>068 107 065 C</b> <b>068 107 101 AF/D</b>	<b>068 197 151</b> <b>068 197 151 A</b> <b>068 197 151 C</b> <b>069 198 151</b> <b>069 198 151 A</b> <b>069 198 151 A</b> <b>A-R43850</b> <b>A-R45270</b> <b>G-0810950000</b> <b>G-0810980000</b> <b>K-800000610000</b> <b>M-02954N0</b> <b>M-02955N0</b>	
NM-Germany Article no. Artikelnummer/ Modelo Número / статья НОМЕР	NM-Germany Article no.	NM-Germany Article no.	NM-Germany Article no.	NM-Germany Article no.	NM-Germany Article no.	NM-Germany Article no.	NM-Germany Article no.
	<b>LBSVW460811DSA</b>	<b>LBVW460811DSA</b>	<b>KBSVW460811DA</b>	<b>KBVW460811DA</b>	<b>KRVW460811DA</b>		

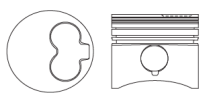

**DIESEL**



ENGINE TYPE	LINER KIT	CYL. LINER	PISTON + RINGS		PISTON SET	RINGS SET	PIN
Motortyp Type de Moteur Tipo de motor Тип двигателя	Liner Kit Kit de Chemise Camisas de los cilindros лайнер комплект	Zylinderlaufbuchse Chemise Camisas de los cilindros втулка цилиндра	Kolben + Ringe Piston + Segments Pistón Set Поршень и кольца		Kolben Set Set de Piston Pistón Set поршневой	Kolben Set Segments de Piston Anillos Set кольца	Pin Axe Perno Пин
<b>1S/CP/CR/CS</b> <b>DW/JK/JP/ME</b> <b>4/6 Cyl</b> <b>76.5 mm Bore Ø</b> <b>1,588 cc 2,383 cc</b>	<b>K-93260960</b> <b>M-0295590</b>		alfin		Top: 1.75 2nd: 2.0 3rd: 3.0 1st oil: 2nd oil:	Ø: 24.0 Length: 64.0	
		Length: 145.0 Outside Ø: 79.5 Flange Ø: 81.5 flange depth 4.7	Length: 71.7 Comp: 41.7 Height: -1.6				
			Reference no.:	Reference no.:	Reference no.:	Reference no.:	O-RING
			<b>G-140283600</b> <b>K-89163190</b> <b>M-029WV13</b>	<b>K-93260600</b> <b>M-0295500</b> <b>N-8710950000</b>	<b>068 107 065 AH</b> <b>068 107 065 AQ</b> <b>068 107 065 BA</b> <b>068 107 065 E/F/N</b> <b>068 107 101 E</b>	<b>068 197 151</b> <b>068 197 151 A</b> <b>068 197 151 C</b> <b>069 198 151</b> <b>069 198 151 A</b> <b>069 198 151 A</b> <b>A-R43850</b> <b>A-R45270</b> <b>G-0810950000</b> <b>G-0810980000</b> <b>K-800000610000</b> <b>M-02954N0</b> <b>M-02955N0</b>	
NM-Germany Article no. Artikelnummer/ Modelo Número / статья НОМЕР	NM-Germany Article no.	NM-Germany Article no.	NM-Germany Article no.	NM-Germany Article no.	NM-Germany Article no.	NM-Germany Article no.	NM-Germany Article no.
	<b>LBSVW460812DSA</b>	<b>LBVW460812DSA</b>	<b>KBSVW460812DA</b>	<b>KBVW460812DA</b>	<b>KRVW460812DA</b>		

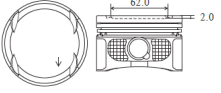

							GASOLINE		
ENGINE TYPE Motortyp Type de Moteur Tipo de motor Тип двигателя	LINER KIT Liner Kit Kit de Chemise Camisas de los cilindros лайнер комплект	CYL. LINER Zylinderlaufbuchse Chemise Camisas de los cilindros втулка цилиндра	PISTON + RINGS Kolben + Ringe Piston + Segments Pistón Set Поршень и кольца		PISTON SET Kolben Set Set de Piston Pistón Set поршневой	RINGS SET Kolben Set Segments de Piston Anillos Set кольца	PIN Pin Axe Perno Пин		
<b>AGY</b> 4 Cyl 76.5 mm Bore Ø 1,423 cc		Length: Outside Ø: Flange Ø: flange depth	Length:	70.6	Comp: 37.9	Height: -2.2	Top:	1.2	Ø: 20.0 Length: 56.8
				2nd:			1.5		
				3rd:			2.5		
		Reference no.:	Reference no.:	Reference no.:	Reference no.:	O-RING			
						A-R60280 G-0850280000 K-800026140000 M-03032N0			
NM-Germany Article no. Artikelnummer/ Modelo Número / статья НОМЕР	NM-Germany Article no.	NM-Germany Article no.	NM-Germany Article no.	NM-Germany Article no.	NM-Germany Article no.	NM-Germany Article no.	NM-Germany Article no.		
			KBSVW40813G	KBVW40813G	KRVW40813G				

							GASOLINE		
ENGINE TYPE Motortyp Type de Moteur Tipo de motor Тип двигателя	LINER KIT Liner Kit Kit de Chemise Camisas de los cilindros лайнер комплект	CYL. LINER Zylinderlaufbuchse Chemise Camisas de los cilindros втулка цилиндра	PISTON + RINGS Kolben + Ringe Piston + Segments Pistón Set Поршень и кольца		PISTON SET Kolben Set Set de Piston Pistón Set поршневой	RINGS SET Kolben Set Segments de Piston Anillos Set кольца	PIN Pin Axe Perno Пин		
<b>AEA/AEE</b> <b>AHS/ALM</b> 4 Cyl 76.5 mm Bore Ø 1,598 cc		Length: Outside Ø: Flange Ø: flange depth	Length:	STD	O/S	Height: -7.8	Top:	1.2	Ø: 17.0 Length: 52.0
				60.2	60.0				
				Comp:	30.9		30.65		
		Reference no.:	Reference no.:	Reference no.:	Reference no.:	O-RING			
		K-94553600 M-0304200 N-8750280010		032 107 065 N	A-R60280 G-0850280000 K-800026140000 M-03032N0				
NM-Germany Article no. Artikelnummer/ Modelo Número / статья НОМЕР	NM-Germany Article no.	NM-Germany Article no.	NM-Germany Article no.	NM-Germany Article no.	NM-Germany Article no.	NM-Germany Article no.	NM-Germany Article no.		
			KBSVW40814G	KBVW40814G	KRVW40814G				

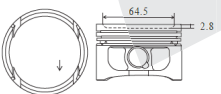
							GASOLINE			
ENGINE TYPE Motortyp Type de Moteur Tipo de motor Тип двигателя	LINER KIT Liner Kit Kit de Chemise Camisas de los cilindros лайнер комплект	CYL. LINER Zylinderlaufbuchse Chemise Camisas de los cilindros втулка цилиндра	PISTON + RINGS Kolben + Ringe Piston + Segments Pistón Set Поршень и кольца		PISTON SET Kolben Set Set de Piston Pistón Set поршневой	RINGS SET Kolben Set Segments de Piston Anillos Set кольца	PIN Pin Axe Perno Пин			
<b>AKK</b> <b>ANW</b> <b>AUD</b> 4 Cyl 76.5 mm Bore Ø 1,390 cc		Length: Outside Ø: Flange Ø: flange depth	Length:	48.5	Comp: 28.5	Height: -5.4	skirt MOS2 treated pin boss gap=20.2mm	Top:	1.2	Ø: 17.0 Length: 52.0
				2nd:			1.5			
				3rd:			2.5			
		Reference no.:	Reference no.:	Reference no.:	Reference no.:	O-RING				
		K-94773600 M-0306300			A-R60280 G-0850280000 K-800026140000 M-03032N0					
NM-Germany Article no. Artikelnummer/ Modelo Número / статья НОМЕР	NM-Germany Article no.	NM-Germany Article no.	NM-Germany Article no.	NM-Germany Article no.	NM-Germany Article no.	NM-Germany Article no.	NM-Germany Article no.			
			KBSVW40815G	KBVW40815G	KRVW40815G					

GASOLINE							
ENGINE TYPE Motortyp Type de Moteur Tipo de motor Тип двигателя	LINER KIT Liner Kit Kit de Chemise Camisas de los cilindros лайнер комплект	CYL. LINER Zylinderlaufbuchse Chemise Camisas de los cilindros втулка цилиндра	PISTON + RINGS Kolben + Ringe Piston + Segments Pistón Set Поршень и кольца		PISTON SET Kolben Set Set de Piston Pistón Set поршневой	RINGS SET Kolben Set Segments de Piston Anillos Set кольца	PIN Pin Axe Perno Пин
<b>AFH/AFK AHW/AKQ APE/AUA/AXP</b>  4 Cyl 76.5 mm Bore Ø 1,390 cc  		Length: Outside Ø: Flange Ø: flange depth	STD	O/S	skirt MOS2 treated	Top: 1.2	Ø: 17.0  Length: 54.0
			Length: 50.0	49.75		2nd: 1.5	
			Comp: 29.0	28.75		3rd: 2.5	
		Height: -2.0	-2.0	1st oil: 2.5	2nd oil:		
		flange depth	-2.3	-2.3			
		Reference no.:	Reference no.:	Reference no.:	Reference no.:	O-RING	
			<b>K-99562600 M-0306100 N-8711610000</b>	<b>036 107 065 AL 036 107 065 E</b>	<b>A-R60280 G-0850280000 K-800026140000 M-03032N0</b>		
NM-Germany Article no. Artikelnummer/ Modelo Número / статья НОМЕР	NM-Germany Article no.	NM-Germany Article no.	NM-Germany Article no.	NM-Germany Article no.	NM-Germany Article no.	NM-Germany Article no.	
			KBSVW40816G	KBVW40816G	KRVW40816G		

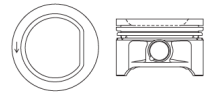
GASOLINE							
ENGINE TYPE Motortyp Type de Moteur Tipo de motor Тип двигателя	LINER KIT Liner Kit Kit de Chemise Camisas de los cilindros лайнер комплект	CYL. LINER Zylinderlaufbuchse Chemise Camisas de los cilindros втулка цилиндра	PISTON + RINGS Kolben + Ringe Piston + Segments Pistón Set Поршень и кольца		PISTON SET Kolben Set Set de Piston Pistón Set поршневой	RINGS SET Kolben Set Segments de Piston Anillos Set кольца	PIN Pin Axe Perno Пин
<b>ATN AZD</b>  4 Cyl 76.5 mm Bore Ø 1,598 cc  		Length: Outside Ø: Flange Ø: flange depth	STD	O/S	skirt MOS2 treated	Top: 1.2	Ø: 17.0  Length: 54.0
			Length: 50.2	50.0		2nd: 1.5	
			Comp: 29.2	29.0		3rd: 2.5	
		Height: -2.8	-2.6	1st oil: 2.5	2nd oil:		
		flange depth					
		Reference no.:	Reference no.:	Reference no.:	Reference no.:	O-RING	
			<b>K-94958600 K-99563600</b>		<b>A-R60280 G-0850280000 K-800026140000 M-03032N0</b>		
NM-Germany Article no. Artikelnummer/ Modelo Número / статья НОМЕР	NM-Germany Article no.	NM-Germany Article no.	NM-Germany Article no.	NM-Germany Article no.	NM-Germany Article no.	NM-Germany Article no.	
			KBSVW40817G	KBVW40817G	KRVW40817G		

GASOLINE							
ENGINE TYPE Motortyp Type de Moteur Tipo de motor Тип двигателя	LINER KIT Liner Kit Kit de Chemise Camisas de los cilindros лайнер комплект	CYL. LINER Zylinderlaufbuchse Chemise Camisas de los cilindros втулка цилиндра	PISTON + RINGS Kolben + Ringe Piston + Segments Pistón Set Поршень и кольца		PISTON SET Kolben Set Set de Piston Pistón Set поршневой	RINGS SET Kolben Set Segments de Piston Anillos Set кольца	PIN Pin Axe Perno Пин
<b>AEX/AKV ANX/APQ</b>  4 Cyl 76.5 mm Bore Ø 1,389 cc  		Length: Outside Ø: Flange Ø: flange depth	STD	0.50 0.75	skirt MOS2 treated pin boss gap=20.2mm	Top: 1.2	Ø: 17.0  Length: 52.0
			Length: 50.35	50.1		2nd: 1.5	
			Comp: 28.35	28.1		3rd: 2.5	
		Height: -5.95	-5.7	1st oil: 2.5	2nd oil:		
		flange depth					
		Reference no.:	Reference no.:	Reference no.:	Reference no.:	O-RING	
			<b>M-0303200 N-8750280000</b>	<b>030 107 065 BK 030 107 103 CP</b>	<b>A-R60280 G-0850280000 K-800026140000 M-03032N0</b>		
NM-Germany Article no. Artikelnummer/ Modelo Número / статья НОМЕР	NM-Germany Article no.	NM-Germany Article no.	NM-Germany Article no.	NM-Germany Article no.	NM-Germany Article no.	NM-Germany Article no.	
			KBSVW40818G	KBVW40818G	KRVW40818G		

**GASOLINE**

ENGINE TYPE Motortyp Type de Moteur Tipo de motor Тип двигателя	LINER KIT Liner Kit Kit de Chemise Camisas de los cilindros лайнер комплект	CYL. LINER Zylinderlaufbuchse Chemise Camisas de los cilindros втулка цилиндра	PISTON + RINGS Kolben + Ringe Piston + Segments Pistón Set Поршень и кольца		PISTON SET Kolben Set Set de Piston Pistón Set поршневой	RINGS SET Kolben Set Segments de Piston Anillos Set кольца	PIN Pin Axe Perno Пин					
<b>CAXA</b> 4 Cyl 76.5 mm Bore Ø 1,390 cc		Length: 50.21 Outside Ø: 29.22 Flange Ø: +2.0 flange depth -4.6	Length: 50.21 Comp: 29.22 Height: +2.0			Top: 1.2 2nd: 1.2 3rd: 2.0 1st oil: 2nd oil:	Ø: 19.0 Length: 52.0					
								Reference no.:	Reference no.:	Reference no.:	Reference no.:	O-RING
									<b>K-40477600</b>	<b>03C 107 065 AP</b>	<b>K-800073340000</b>	
NM-Germany Article no. Artikelnummer/ Modelo Número / статья HOMEP	NM-Germany Article no.	NM-Germany Article no.	NM-Germany Article no.	NM-Germany Article no.	NM-Germany Article no.	NM-Germany Article no.	NM-Germany Article no.					
			<b>KBSVW40819G</b>	<b>KBVW40819G</b>	<b>KRVW40819G</b>							

VW

**DIESEL**

ENGINE TYPE Motortyp Type de Moteur Tipo de motor Тип двигателя	LINER KIT Liner Kit Kit de Chemise Camisas de los cilindros лайнер комплект	CYL. LINER Zylinderlaufbuchse Chemise Camisas de los cilindros втулка цилиндра	PISTON + RINGS Kolben + Ringe Piston + Segments Pistón Set Поршень и кольца		PISTON SET Kolben Set Set de Piston Pistón Set поршневой	RINGS SET Kolben Set Segments de Piston Anillos Set кольца	PIN Pin Axe Perno Пин					
<b>AFB TURBO AKN TURBO</b> 6 Cyl 78.3 mm Bore Ø 2,496 cc		Length: 155.0 Outside Ø: 82.0 Flange Ø: 84.0 flange depth 3.0	Length: 71.83 Comp: 47.83 Height: -6.5	STD 71.58 O/S 47.58 -6.5 -6.5	alfin and with oil gallery skirt MOS2 treated	Top: 1.75 2nd: 2.0 3rd: 3.0 1st oil: 2nd oil:	Ø: 26.0 Length: 65.5					
								Reference no.:	Reference no.:	Reference no.:	Reference no.:	O-RING
									<b>K-99776600 M-0334000</b>	<b>059 107 066 E 059 107 105 H</b>	<b>059 198 151 H A-R66900 G-0810300000 K-800051540000 M-03340V0</b>	
NM-Germany Article no. Artikelnummer/ Modelo Número / статья HOMEP	NM-Germany Article no.	NM-Germany Article no.	NM-Germany Article no.	NM-Germany Article no.	NM-Germany Article no.	NM-Germany Article no.	NM-Germany Article no.					
	<b>LBSVW60820DSB (for cyl 1/2/3)</b>	<b>LBVW60820DSB</b>	<b>KBSVW60820DB (for cyl 1/2/3)</b>	<b>KBVW60820DB (for cyl 1/2/3)</b>	<b>KRVW60820DB</b>							

**DIESEL**

ENGINE TYPE Motortyp Type de Moteur Tipo de motor Тип двигателя	LINER KIT Liner Kit Kit de Chemise Camisas de los cilindros лайнер комплект	CYL. LINER Zylinderlaufbuchse Chemise Camisas de los cilindros втулка цилиндра	PISTON + RINGS Kolben + Ringe Piston + Segments Pistón Set Поршень и кольца		PISTON SET Kolben Set Set de Piston Pistón Set поршневой	RINGS SET Kolben Set Segments de Piston Anillos Set кольца	PIN Pin Axe Perno Пин					
<b>AFB TURBO AKN TURBO</b> 6 Cyl 78.3 mm Bore Ø 2,496 cc		Length: 155.0 Outside Ø: 82.0 Flange Ø: 84.0 flange depth 3.0	Length: 71.83 Comp: 47.83 Height: -6.5	STD 71.58 O/S 47.58 -6.5 -6.5	alfin and with oil gallery skirt MOS2 treated	Top: 1.75 2nd: 2.0 3rd: 3.0 1st oil: 2nd oil:	Ø: 26.0 Length: 65.5					
								Reference no.:	Reference no.:	Reference no.:	Reference no.:	O-RING
									<b>K-99777600 M-0334100</b>	<b>059 107 065 N 059 107 065 Q 059 107 065 R</b>	<b>059 198 151 H A-R66900 G-0810300000 K-800051540000 M-03340V0</b>	
NM-Germany Article no. Artikelnummer/ Modelo Número / статья HOMEP	NM-Germany Article no.	NM-Germany Article no.	NM-Germany Article no.	NM-Germany Article no.	NM-Germany Article no.	NM-Germany Article no.	NM-Germany Article no.					
	<b>LBSVW60821DSB (for cyl 4/5/6)</b>	<b>LBVW60821DSB</b>	<b>KBSVW60821DB (for cyl 4/5/6)</b>	<b>KBVW60821DB (for cyl 4/5/6)</b>	<b>KRVW60821DB</b>							









**DIESEL**

ENGINE TYPE Motortyp Type de Moteur Tipo de motor Тип двигателя	LINER KIT Liner Kit Kit de Chemise Camisas de los cilindros лайнер комплект	CYL. LINER Zylinderlaufbuchse Chemise Camisas de los cilindros втулка цилиндра	PISTON + RINGS Kolben + Ringe Piston + Segments Pistón Set Поршень и кольца		PISTON SET Kolben Set Set de Piston Pistón Set поршень	RINGS SET Kolben Set Segments de Piston Anillos Set кольца	PIN Pin Axe Perno Пин	
<b>1Z/AEY/AFN TURBO</b> <b>AGD/AHF/AHH TURBO</b> 4 Cyl 79.5 mm Bore Ø 1,896 cc	<b>K-94428970</b>	Length: 152.0 Outside Ø: 82.5 Flange Ø: 85.5 flange depth 4.7	Length: 71.8 Comp: 45.8 Height: -8.8	STD 0.25 0.50 1.00 71.8 45.55 -8.8	alfin top ring land and skirt MOS2 treated pin bushing inserted	Top: 1.75 2nd: 2.0 3rd: 3.0 1st oil: 2nd oil:	Ø: 26.0 Length: 66.0	
		Reference no.:	Reference no.:	Reference no.:		Reference no.:		O-RING
		<b>A-SU351317</b> <b>G-1402795000</b> <b>K-89434190</b> <b>M-029WV20</b>	<b>K-94428700</b> <b>M-0304100</b> <b>N-8711490090</b>	<b>038 107 065 J</b>		<b>A-R60370</b> <b>G-0811490000</b> <b>K-800000810000</b> <b>K-800051640000</b> <b>M-03020N0</b>		
NM-Germany Article no. Artikelnummer/ Modelo Número / статья НОМЕР	NM-Germany Article no.	NM-Germany Article no.	NM-Germany Article no.	NM-Germany Article no.	NM-Germany Article no.	NM-Germany Article no.	NM-Germany Article no.	
	<b>LBSVW40828DSA</b> (for cyl 3/4)	<b>LBVW40828DSA</b>	<b>KBSVW40828DA</b> (for cyl 3/4)	<b>KBVW40828DA</b> (for cyl 3/4)	<b>KRVW40828DA</b>			

**DIESEL**

ENGINE TYPE Motortyp Type de Moteur Tipo de motor Тип двигателя	LINER KIT Liner Kit Kit de Chemise Camisas de los cilindros лайнер комплект	CYL. LINER Zylinderlaufbuchse Chemise Camisas de los cilindros втулка цилиндра	PISTON + RINGS Kolben + Ringe Piston + Segments Pistón Set Поршень и кольца		PISTON SET Kolben Set Set de Piston Pistón Set поршень	RINGS SET Kolben Set Segments de Piston Anillos Set кольца	PIN Pin Axe Perno Пин	
<b>1X/1Y/AAB</b> <b>ADG/AEF/AJA</b> 4/5 Cyl 79.5 mm Bore Ø 1,896 cc 2,370 cc	<b>K-91386960</b> <b>M-0298290</b>	Length: 152.0 Outside Ø: 82.5 Flange Ø: 85.5 flange depth 4.7	Length: 65.7 Comp: 39.65 Height: -1.9	STD 0.25 0.50 1.00 65.7 39.4 -1.9	alfin	Top: 1.75 2nd: 2.0 3rd: 3.0 1st oil: 2nd oil:	Ø: 24.0 Length: 64.0	
		Reference no.:	Reference no.:	Reference no.:		Reference no.:		O-RING
		<b>A-SU351317</b> <b>G-1402795000</b> <b>K-89434190</b> <b>M-029WV20</b>	<b>K-91386600</b> <b>M-0298200</b> <b>N-8799010040</b>			<b>A-R60370</b> <b>G-0811490000</b> <b>K-800000810000</b> <b>K-800051640000</b> <b>M-03020N0</b>		
NM-Germany Article no. Artikelnummer/ Modelo Número / статья НОМЕР	NM-Germany Article no.	NM-Germany Article no.	NM-Germany Article no.	NM-Germany Article no.	NM-Germany Article no.	NM-Germany Article no.	NM-Germany Article no.	
	<b>LBSVW450829DSA</b>	<b>LBVW450829DSA</b>	<b>KBSVW450829DA</b>	<b>KBVW450829DA</b>	<b>KRVW450829DA</b>			

**DIESEL**

ENGINE TYPE Motortyp Type de Moteur Tipo de motor Тип двигателя	LINER KIT Liner Kit Kit de Chemise Camisas de los cilindros лайнер комплект	CYL. LINER Zylinderlaufbuchse Chemise Camisas de los cilindros втулка цилиндра	PISTON + RINGS Kolben + Ringe Piston + Segments Pistón Set Поршень и кольца		PISTON SET Kolben Set Set de Piston Pistón Set поршень	RINGS SET Kolben Set Segments de Piston Anillos Set кольца	PIN Pin Axe Perno Пин	
<b>AAZ TURBO</b> <b>ABL TURBO</b> <b>ADE TURBO</b> 4 Cyl 79.5 mm Bore Ø 1,896 cc	<b>K-91429960</b> <b>M-0299690</b>	Length: 152.0 Outside Ø: 82.5 Flange Ø: 85.5 flange depth 4.7	Length: 71.65 Comp: 45.65 Height: -1.9	STD 0.25 0.50 1.00 71.65 45.4 -1.9	alfin head anodized skirt MOS2 treated	Top: 1.75 2nd: 2.0 3rd: 3.0 1st oil: 2nd oil:	Ø: 26.0 Length: 66.0	
		Reference no.:	Reference no.:	Reference no.:		Reference no.:		O-RING
		<b>A-SU351317</b> <b>G-1402795000</b> <b>K-89434190</b> <b>M-029WV20</b>	<b>K-91429600</b> <b>M-0299600</b> <b>N-8799010010</b>			<b>A-R60370</b> <b>G-0811490000</b> <b>K-800000810000</b> <b>K-800051640000</b> <b>M-03020N0</b>		
NM-Germany Article no. Artikelnummer/ Modelo Número / статья НОМЕР	NM-Germany Article no.	NM-Germany Article no.	NM-Germany Article no.	NM-Germany Article no.	NM-Germany Article no.	NM-Germany Article no.	NM-Germany Article no.	
	<b>LBSVW40830DSA</b>	<b>LBVW40830DSA</b>	<b>KBSVW40830DA</b>	<b>KBVW40830DA</b>	<b>KRVW40830DA</b>			

## DIESEL

ENGINE TYPE Motortyp Type de Moteur Tipo de motor Тип двигателя	LINER KIT Liner Kit Kit de Chemise Camisas de los cilindros лайнер комплект	CYL. LINER Zylinderlaufbuchse Chemise Camisas de los cilindros втулка цилиндра	PISTON + RINGS Kolben + Ringe Piston + Segments Pistón Set Поршень и кольца		PISTON SET Kolben Set Set de Piston Pistón Set поршневой	RINGS SET Kolben Set Segments de Piston Anillos Set кольца	PIN Pin Axe Perno Пин	
<b>ARL/ASZ TURBO AVF/AWX TURBO</b>  4 Cyl 79.5 mm Bore Ø 1,896 cc		Length: 152.0 Outside Ø: 82.5 Flange Ø: 85.5 flange depth 4.7	STD	O/S	alfin and with oil gallery skirt MOS2 treated pin bushing inserted fits tapered con. rod	Top: 1.75 2nd: 2.0 3rd: 3.0 1st oil: 2nd oil:	Ø: 26.0 Length: 66.0	
			Reference no.:	Reference no.:		Reference no.:	Reference no.:	O-RING
			<b>A-SU351317 G-1402795000 K-89434190 M-029WV20</b>	<b>K-99470600 M-0308600 N-8711490045</b>			<b>A-R60370 G-0811490000 K-80000810000 K-800051640000 M-03020N0</b>	
NM-Germany Article no. Artikelnummer/ Modelo Número / статья НОМЕР	NM-Germany Article no.	NM-Germany Article no.	NM-Germany Article no.	NM-Germany Article no.	NM-Germany Article no.	NM-Germany Article no.		
	<b>LBSVW40831DSB</b> (for cyl 1/2)	<b>LBVW40831DSB</b>	<b>KBSVW40831DB</b> (for cyl 1/2)	<b>KBVW40831DB</b> (for cyl 1/2)	<b>KRVW40831DB</b>			

VW

## DIESEL

ENGINE TYPE Motortyp Type de Moteur Tipo de motor Тип двигателя	LINER KIT Liner Kit Kit de Chemise Camisas de los cilindros лайнер комплект	CYL. LINER Zylinderlaufbuchse Chemise Camisas de los cilindros втулка цилиндра	PISTON + RINGS Kolben + Ringe Piston + Segments Pistón Set Поршень и кольца		PISTON SET Kolben Set Set de Piston Pistón Set поршневой	RINGS SET Kolben Set Segments de Piston Anillos Set кольца	PIN Pin Axe Perno Пин	
<b>ARL/ASZ TURBO AVF/AWX TURBO</b>  4 Cyl 79.5 mm Bore Ø 1,896 cc		Length: 152.0 Outside Ø: 82.5 Flange Ø: 85.5 flange depth 4.7	STD	O/S	alfin and with oil gallery skirt MOS2 treated pin bushing inserted fits tapered con. rod	Top: 1.75 2nd: 2.0 3rd: 3.0 1st oil: 2nd oil:	Ø: 26.0 Length: 66.0	
			Reference no.:	Reference no.:		Reference no.:	Reference no.:	O-RING
			<b>A-SU351317 G-1402795000 K-89434190 M-029WV20</b>	<b>K-99471600 M-0308700 N-8711490046</b>			<b>A-R60370 G-0811490000 K-80000810000 K-800051640000 M-03020N0</b>	
NM-Germany Article no. Artikelnummer/ Modelo Número / статья НОМЕР	NM-Germany Article no.	NM-Germany Article no.	NM-Germany Article no.	NM-Germany Article no.	NM-Germany Article no.	NM-Germany Article no.		
	<b>LBSVW40832DSB</b> (for cyl 3/4)	<b>LBVW40832DSB</b>	<b>KBSVW40832DB</b> (for cyl 3/4)	<b>KBVW40832DB</b> (for cyl 3/4)	<b>KRVW40832DB</b>			

## DIESEL

ENGINE TYPE Motortyp Type de Moteur Tipo de motor Тип двигателя	LINER KIT Liner Kit Kit de Chemise Camisas de los cilindros лайнер комплект	CYL. LINER Zylinderlaufbuchse Chemise Camisas de los cilindros втулка цилиндра	PISTON + RINGS Kolben + Ringe Piston + Segments Pistón Set Поршень и кольца		PISTON SET Kolben Set Set de Piston Pistón Set поршневой	RINGS SET Kolben Set Segments de Piston Anillos Set кольца	PIN Pin Axe Perno Пин	
<b>AJM/ATJ TURBO AUY/BVK TURBO</b>  4 Cyl 79.5 mm Bore Ø 1,896 cc		Length: 152.0 Outside Ø: 82.5 Flange Ø: 85.5 flange depth 4.7	STD	O/S	alfin and with oil gallery top ring land and skirt MOS2 treated pin bushing inserted fits tapered con. rod	Top: 1.75 2nd: 2.0 3rd: 3.0 1st oil: 2nd oil:	Ø: 26.0 Length: 66.0	
			Reference no.:	Reference no.:		Reference no.:	Reference no.:	O-RING
			<b>A-SU351317 G-1402795000 K-89434190 M-029WV20</b>	<b>K-99842600 M-0305600 N-8711490005</b>			<b>A-R60370 G-0811490000 K-80000810000 K-800051640000 M-03020N0</b>	
NM-Germany Article no. Artikelnummer/ Modelo Número / статья НОМЕР	NM-Germany Article no.	NM-Germany Article no.	NM-Germany Article no.	NM-Germany Article no.	NM-Germany Article no.	NM-Germany Article no.		
	<b>LBSVW40833DSB</b> (for cyl 1/2)	<b>LBVW40833DSB</b>	<b>KBSVW40833DB</b> (for cyl 1/2)	<b>KBVW40833DB</b> (for cyl 1/2)	<b>KRVW40833DB</b>			

## DIESEL

ENGINE TYPE Motortyp Type de Moteur Tipo de motor Тип двигателя	LINER KIT Liner Kit Kit de Chemise Camisas de los cilindros лайнер комплект	CYL. LINER Zylinderlaufbuchse Chemise Camisas de los cilindros втулка цилиндра	PISTON + RINGS Kolben + Ringe Piston + Segments Pistón Set Поршень и кольца		PISTON SET Kolben Set Set de Piston Pistón Set поршень	RINGS SET Kolben Set Segments de Piston Anillos Set кольца	PIN Pin Axe Perno Пин			
<b>AJM/ATJ TURBO AUY/BVK TURBO</b>  4 Cyl 79.5 mm Bore Ø 1,896 cc		Length: 152.0 Outside Ø: 82.5 Flange Ø: 85.5 flange depth: 4.7	STD	O/S	alfin and with oil gallery top ring land and skirt MOS2 treated pin bushing inserted fits tapered con. rod	Top: 1.75 2nd: 2.0 3rd: 3.0 1st oil: 3.0 2nd oil:	Ø: 26.0 Length: 66.0			
			Length: 69.8	69.55		Comp: 45.8		45.55	Height: -10.4	-10.4
<b>Reference no.:</b>		<b>Reference no.:</b>		<b>Reference no.:</b>	<b>Reference no.:</b>	<b>O-RING</b>				
A-SU351317 G-1402795000 K-89434190 M-029WV20		K-99843600 M-0305700 N-8711490015			A-R60370 G-0811490000 K-80000810000 K-800051640000 M-03020N0					
NM-Germany Article no. Artikelnummer/ Modelo Número / статья НОМЕР	NM-Germany Article no.	NM-Germany Article no.	NM-Germany Article no.	NM-Germany Article no.	NM-Germany Article no.	NM-Germany Article no.				
	LBSVW40834DSB (for cyl 3/4)	LBVW40834DSB	KBSVW40834DB (for cyl 3/4)	KBVW40834DB (for cyl 3/4)	KRVW40834DB					



## DIESEL

ENGINE TYPE Motortyp Type de Moteur Tipo de motor Тип двигателя	LINER KIT Liner Kit Kit de Chemise Camisas de los cilindros лайнер комплект	CYL. LINER Zylinderlaufbuchse Chemise Camisas de los cilindros втулка цилиндра	PISTON + RINGS Kolben + Ringe Piston + Segments Pistón Set Поршень и кольца		PISTON SET Kolben Set Set de Piston Pistón Set поршень	RINGS SET Kolben Set Segments de Piston Anillos Set кольца	PIN Pin Axe Perno Пин			
<b>ANU/ATD/AVB/ AVQ/AXR/BEW/ BJB/BKC/BRU/ BSW/BXE/BXF/ BXJ</b>  Cyl 4 Bore Ø 79.5 mm 1,896 cc		Length: 152.0 Outside Ø: 82.5 Flange Ø: 85.5 4.7	STD	O/S	alfin and with oil gallery skirt MOS2 treated pin bushing inserted fits tapered con. rod	Top: 1.75 2nd: 2.0 3rd: 3.0 1st oil: 3.0 2nd oil:	Ø: 26.0 Length: 66.0			
			Length: 69.8	69.55		Comp: 45.8		45.55	Height: -1.1	-1.1
<b>Reference no.:</b>		<b>Reference no.:</b>		<b>Reference no.:</b>	<b>Reference no.:</b>	<b>O-RING</b>				
A-SU351317 G-1402795000 K-89434190 M-029WV20		K-99850600 M-0306500			A-R60370 G-0811490000 K-80000810000 K-800051640000 M-03020N0					
NM-Germany Article no. Artikelnummer/ Modelo Número / статья НОМЕР	NM-Germany Article no.	NM-Germany Article no.	NM-Germany Article no.	NM-Germany Article no.	NM-Germany Article no.	NM-Germany Article no.				
	LBSVW40835DSA (for cyl 1/2)	LBVW40835DSA	KBSVW40835DA (for cyl 1/2)	KBVW40835DA (for cyl 1/2)	KRVW40835DB					

## DIESEL

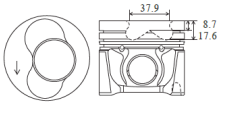

ENGINE TYPE Motortyp Type de Moteur Tipo de motor Тип двигателя	LINER KIT Liner Kit Kit de Chemise Camisas de los cilindros лайнер комплект	CYL. LINER Zylinderlaufbuchse Chemise Camisas de los cilindros втулка цилиндра	PISTON + RINGS Kolben + Ringe Piston + Segments Pistón Set Поршень и кольца		PISTON SET Kolben Set Set de Piston Pistón Set поршень	RINGS SET Kolben Set Segments de Piston Anillos Set кольца	PIN Pin Axe Perno Пин			
<b>ANU/ATD/AVB/ AVQ/AXR/BEW/ BJB/BKC/BRU/ BSW/BXE/BXF/ BXJ</b>  Cyl 4 Bore Ø 79.5 mm 1,896 cc		Length: 152.0 Outside Ø: 82.5 Flange Ø: 85.5 4.7	STD	O/S		Top: 1.75 2nd: 2.0 3rd: 3.0 1st oil: 3.0 2nd oil:	Ø: 26.0 Length: 66.0			
			Length: 69.8	69.55		Comp: 45.8		45.55	Height: -1.1	-1.1
<b>Reference no.:</b>		<b>Reference no.:</b>		<b>Reference no.:</b>	<b>Reference no.:</b>	<b>O-RING</b>				
A-SU351317 G-1402795000 K-89434190 M-029WV20		K-99851600 M-0306600			A-R60370 G-0811490000 K-80000810000 K-800051640000 M-03020N0					
NM-Germany Article no. Artikelnummer/ Modelo Número / статья НОМЕР	NM-Germany Article no.	NM-Germany Article no.	NM-Germany Article no.	NM-Germany Article no.	NM-Germany Article no.	NM-Germany Article no.				
	LBSVW40836DSA (for cyl 3/4)	LBVW40836DSA	KBSVW40836DA (for cyl 3/4)	KBVW40836DA (for cyl 3/4)	KRVW40836DB					

**DIESEL**

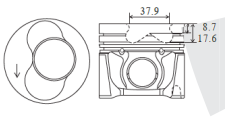

ENGINE TYPE Motortyp Type de Moteur Tipo de motor Тип двигателя	LINER KIT Liner Kit Kit de Chemise Camisas de los cilindros лайнер комплект	CYL. LINER Zylinderlaufbuchse Chemise Camisas de los cilindros втулка цилиндра	PISTON + RINGS Kolben + Ringe Piston + Segments Pistón Set Поршень и кольца		PISTON SET Kolben Set Set de Piston Pistón Set поршневой	RINGS SET Kolben Set Segments de Piston Anillos Set кольца	Pin Axe Perno Пин
<b>AMF BAY</b> 3 Cyl 79.5 mm Bore Ø 1,422 cc 		Length: 152.0 Outside Ø: 82.5 Flange Ø: 85.5 flange depth 4.7	Length: 69.8 Comp: 45.8 Height: -8.7	STD 69.8 O/S 45.5 -8.7 -17.6	alfin top ring land and skirt MOS2 treated pin bushing inserted fits tapered con. rod	Top: 1.75 2nd: 2.0 3rd: 3.0 1st oil: 2nd oil:	Ø: 26.0 Length: 63.0
		Reference no.:	Reference no.:	Reference no.:	Reference no.:	O-RING	
		<b>A-SU351317</b> <b>G-1402795000</b> <b>K-89434190</b> <b>M-029WV20</b>	<b>M-0305400</b>		<b>A-R60370</b> <b>G-0811490000</b> <b>K-800000810000</b> <b>K-800051640000</b> <b>M-03020N0</b>		
		NM-Germany Article no. Artikelnummer/ Modelo Número / статья НОМЕР	NM-Germany Article no.	NM-Germany Article no.	NM-Germany Article no.	NM-Germany Article no.	NM-Germany Article no.
	LBSVW30837DSA (for cyl 1/2)	LBVW30837DSA	KBSVW30837DA (for cyl 1/2)	KBVW30837DA (for cyl 1/2)	KRVW30837DA		

VW

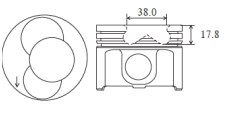

**DIESEL**

ENGINE TYPE Motortyp Type de Moteur Tipo de motor Тип двигателя	LINER KIT Liner Kit Kit de Chemise Camisas de los cilindros лайнер комплект	CYL. LINER Zylinderlaufbuchse Chemise Camisas de los cilindros втулка цилиндра	PISTON + RINGS Kolben + Ringe Piston + Segments Pistón Set Поршень и кольца		PISTON SET Kolben Set Set de Piston Pistón Set поршневой	RINGS SET Kolben Set Segments de Piston Anillos Set кольца	Pin Axe Perno Пин
<b>AMF BAY</b> 3 Cyl 79.5 mm Bore Ø 1,422 cc 		Length: 152.0 Outside Ø: 82.5 Flange Ø: 85.5 flange depth 4.7	Length: 69.8 Comp: 45.8 Height: -8.7	STD 69.8 O/S 45.5 -8.7 -17.6	alfin top ring land and skirt MOS2 treated pin bushing inserted fits tapered con. rod	Top: 1.75 2nd: 2.0 3rd: 3.0 1st oil: 2nd oil:	Ø: 26.0 Length: 63.0
		Reference no.:	Reference no.:	Reference no.:	Reference no.:	O-RING	
		<b>A-SU351317</b> <b>G-1402795000</b> <b>K-89434190</b> <b>M-029WV20</b>	<b>M-0305500</b>		<b>A-R60370</b> <b>G-0811490000</b> <b>K-800000810000</b> <b>K-800051640000</b> <b>M-03020N0</b>		
		NM-Germany Article no. Artikelnummer/ Modelo Número / статья НОМЕР	NM-Germany Article no.	NM-Germany Article no.	NM-Germany Article no.	NM-Germany Article no.	NM-Germany Article no.
	LBSVW30838DSA (for cyl 3)	LBVW30838DSA	KBSVW30838DA (for cyl 3)	KBVW30838DA (for cyl 3)	KRVW30838DA		

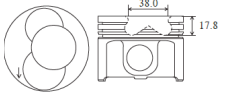

**DIESEL**

ENGINE TYPE Motortyp Type de Moteur Tipo de motor Тип двигателя	LINER KIT Liner Kit Kit de Chemise Camisas de los cilindros лайнер комплект	CYL. LINER Zylinderlaufbuchse Chemise Camisas de los cilindros втулка цилиндра	PISTON + RINGS Kolben + Ringe Piston + Segments Pistón Set Поршень и кольца		PISTON SET Kolben Set Set de Piston Pistón Set поршневой	RINGS SET Kolben Set Segments de Piston Anillos Set кольца	Pin Axe Perno Пин
<b>AGP/ANC/AQM ASY/AYQ/BGL BGM/CDXA/CDXB</b> 4 Cyl 79.5 mm Bore Ø 1,896 cc 	<b>K-40092970</b> <b>M-0308090</b>	Length: 152.0 Outside Ø: 82.5 Flange Ø: 85.5 flange depth 4.7	Length: 60.8 Comp: 39.8 Height: -17.8		alfin	Top: 1.75 2nd: 2.0 3rd: 3.0 1st oil: 2nd oil:	Ø: 24.0 Length: 59.0
		Reference no.:	Reference no.:	Reference no.:	Reference no.:	O-RING	
		<b>A-SU351317</b> <b>G-1402795000</b> <b>K-89434190</b> <b>M-029WV20</b>	<b>K-40092700</b> <b>M-0308000</b> <b>N-8711490020</b>		<b>A-R60370</b> <b>G-0811490000</b> <b>K-800000810000</b> <b>K-800051640000</b> <b>M-03020N0</b>		
		NM-Germany Article no. Artikelnummer/ Modelo Número / статья НОМЕР	NM-Germany Article no.	NM-Germany Article no.	NM-Germany Article no.	NM-Germany Article no.	NM-Germany Article no.
	LBSVW40839DSA (for cyl 1/2)	LBVW40839DSA	KBSVW40839DA (for cyl 1/2)	KBVW40839DA (for cyl 1/2)	KRVW40839DA		

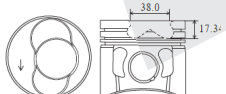

**DIESEL**

ENGINE TYPE Motortyp Type de Moteur Tipo de motor Тип двигателя	LINER KIT Liner Kit Kit de Chemise Camisas de los cilindros лайнер комплект	CYL. LINER Zylinderlaufbuchse Chemise Camisas de los cilindros втулка цилиндра	PISTON + RINGS Kolben + Ringe Piston + Segments Pistón Set Поршень и кольца			PISTON SET Kolben Set Set de Piston Pistón Set поршневой	RINGS SET Kolben Set Segments de Piston Anillos Set кольца	PIN Pin Axe Perno Пин
<b>AGP/ANC/AQM ASY/AYQ/BGL BGM/CDXA/CDXB</b>  <b>4 Cyl</b>  <b>79.5 mm Bore Ø</b>  <b>1,896 cc</b>  	<b>K-40093970 M-0308190</b>	Length: 152.0 Outside Ø: 82.5 Flange Ø: 85.5 flange depth: 4.7	Length: 60.8 Comp: 39.8 Height: -17.8		alfin	Top: 1.75 2nd: 2.0 3rd: 3.0 1st oil: 2nd oil:	Ø: 24.0  Length: 59.0	
		Reference no.:	Reference no.:	Reference no.:	Reference no.:	O-RING		
		<b>A-SU351317 G-1402795000 K-89434190 M-029WV20</b>	<b>K-40093700 M-0308100 N-8711490030</b>		<b>A-R60370 G-0811490000 K-80000810000 K-800051640000 M-03020N0</b>			
NM-Germany Article no. Artikelnummer/ Modelo Número / статья НОМЕР	NM-Germany Article no.	NM-Germany Article no.	NM-Germany Article no.	NM-Germany Article no.	NM-Germany Article no.	NM-Germany Article no.	NM-Germany Article no.	
	<b>LBSVW40840DSA</b> (for cyl 3/4)	<b>LBVW40840DSA</b>	<b>KBSVW40840DA</b> (for cyl 3/4)	<b>KBVW40840DA</b> (for cyl 3/4)	<b>KRVW40840DA</b>			



**DIESEL**

ENGINE TYPE Motortyp Type de Moteur Tipo de motor Тип двигателя	LINER KIT Liner Kit Kit de Chemise Camisas de los cilindros лайнер комплект	CYL. LINER Zylinderlaufbuchse Chemise Camisas de los cilindros втулка цилиндра	PISTON + RINGS Kolben + Ringe Piston + Segments Pistón Set Поршень и кольца			PISTON SET Kolben Set Set de Piston Pistón Set поршневой	RINGS SET Kolben Set Segments de Piston Anillos Set кольца	PIN Pin Axe Perno Пин
<b>BJB/BLS BMT/BSU BXE/BXF/BXJ</b>  <b>4 Cyl</b>  <b>79.5 mm Bore Ø</b>  <b>1,896 cc</b>  			STD 0.25 0.50 1.00 Length: 69.8 69.55 Outside Ø: 45.8 45.55 Flange Ø: 45.8 45.55 Height: -17.34 -17.34 flange depth		alfin pin bushing inserted fits tapered con. rod	Top: 1.75 2nd: 2.0 3rd: 3.0 1st oil: 2nd oil:	Ø: 26.0  Length: 66.0	
		Reference no.:	Reference no.:	Reference no.:	Reference no.:	O-RING		
			<b>K-40421600</b>		<b>A-R60370 G-0811490000 K-80000810000 K-800051640000 M-03020N0</b>			
NM-Germany Article no. Artikelnummer/ Modelo Número / статья НОМЕР	NM-Germany Article no.	NM-Germany Article no.	NM-Germany Article no.	NM-Germany Article no.	NM-Germany Article no.	NM-Germany Article no.	NM-Germany Article no.	
			<b>KBSVW40841DA</b>	<b>KBVW40841DA</b>	<b>KRVW40841DA</b>			

**DIESEL**

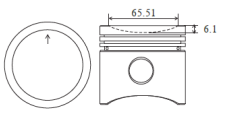

ENGINE TYPE Motortyp Type de Moteur Tipo de motor Тип двигателя	LINER KIT Liner Kit Kit de Chemise Camisas de los cilindros лайнер комплект	CYL. LINER Zylinderlaufbuchse Chemise Camisas de los cilindros втулка цилиндра	PISTON + RINGS Kolben + Ringe Piston + Segments Pistón Set Поршень и кольца			PISTON SET Kolben Set Set de Piston Pistón Set поршневой	RINGS SET Kolben Set Segments de Piston Anillos Set кольца	PIN Pin Axe Perno Пин
<b>BJB/BLS BMT/BSU BXE/BXF/BXJ</b>  <b>4 Cyl</b>  <b>79.5 mm Bore Ø</b>  <b>1,896 cc</b>  			STD 0.25 0.50 1.00 Length: 69.8 69.55 Outside Ø: 45.8 45.55 Flange Ø: 45.8 45.55 Height: -17.34 -17.34 flange depth		alfin pin bushing inserted fits tapered con. rod	Top: 1.75 2nd: 2.0 3rd: 3.0 1st oil: 2nd oil:	Ø: 26.0  Length: 66.0	
		Reference no.:	Reference no.:	Reference no.:	Reference no.:	O-RING		
			<b>K-40422600</b>		<b>A-R60370 G-0811490000 K-80000810000 K-800051640000 M-03020N0</b>			
NM-Germany Article no. Artikelnummer/ Modelo Número / статья НОМЕР	NM-Germany Article no.	NM-Germany Article no.	NM-Germany Article no.	NM-Germany Article no.	NM-Germany Article no.	NM-Germany Article no.	NM-Germany Article no.	
			<b>KBSVW40842DA</b>	<b>KBVW40842DA</b>	<b>KRVW40842DA</b>			

**GASOLINE**

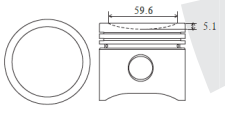

ENGINE TYPE Motortyp Type de Moteur Tipo de motor Тип двигателя	LINER KIT Liner Kit Kit de Chemise Camisas de los cilindros лайнер комплект	CYL. LINER Zylinderlaufbuchse Chemise Camisas de los cilindros втулка цилиндра	PISTON + RINGS Kolben + Ringe Piston + Segments Pistón Set Поршень и кольца			PISTON SET Kolben Set Set de Piston Pistón Set поршневой	RINGS SET Kolben Set Segments de Piston Anillos Set кольца	PIN Pin Axe Perno Пин
<b>FR FP WY</b> 4 Cyl 79.5 mm Bore Ø 1,588 cc  		Length:		Length:	73.8	Top:	1.75	Ø: 22.0 Length: 63.0
		Outside Ø:		Comp:	41.8	2nd:	2.0	
		Flange Ø:		Height:	-6.1	3rd:	4.0	
		flange depth				1st oil:	4.0	
			<b>Reference no.:</b>	<b>Reference no.:</b>	<b>Reference no.:</b>	<b>Reference no.:</b>	<b>O-RING</b>	
						A-R40200 G-0840410000 K-800000911000 K-800000941000 M-03459V0 T-50003		
NM-Germany Article no. Artikelnummer/ Modelo Número / статья НОМЕР	NM-Germany Article no.	NM-Germany Article no.	NM-Germany Article no.	NM-Germany Article no.	NM-Germany Article no.	NM-Germany Article no.	NM-Germany Article no.	NM-Germany Article no.
			KBSVW40843G	KBVW40843G	KRVW40843G			

VW

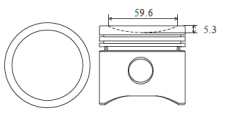

**GASOLINE**

ENGINE TYPE Motortyp Type de Moteur Tipo de motor Тип двигателя	LINER KIT Liner Kit Kit de Chemise Camisas de los cilindros лайнер комплект	CYL. LINER Zylinderlaufbuchse Chemise Camisas de los cilindros втулка цилиндра	PISTON + RINGS Kolben + Ringe Piston + Segments Pistón Set Поршень и кольца			PISTON SET Kolben Set Set de Piston Pistón Set поршневой	RINGS SET Kolben Set Segments de Piston Anillos Set кольца	PIN Pin Axe Perno Пин
<b>YN YP</b> 4 Cyl 79.5 mm Bore Ø 1,588 cc  		Length:		Length:	75.2	Top:	1.75	Ø: 22.0 Length: 63.5
		Outside Ø:		Comp:	45.3	2nd:	2.0	
		Flange Ø:		Height:	-5.1	3rd:	4.0	
		flange depth				1st oil:	4.0	
			<b>Reference no.:</b>	<b>Reference no.:</b>	<b>Reference no.:</b>	<b>Reference no.:</b>	<b>O-RING</b>	
						A-R40200 G-0840410000 K-800000911000 K-800000941000 M-03459V0 T-50003		
NM-Germany Article no. Artikelnummer/ Modelo Número / статья НОМЕР	NM-Germany Article no.	NM-Germany Article no.	NM-Germany Article no.	NM-Germany Article no.	NM-Germany Article no.	NM-Germany Article no.	NM-Germany Article no.	NM-Germany Article no.
			KBSVW40844G	KBVW40844G	KRVW40844G			

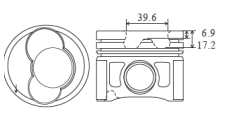

**GASOLINE**

ENGINE TYPE Motortyp Type de Moteur Tipo de motor Тип двигателя	LINER KIT Liner Kit Kit de Chemise Camisas de los cilindros лайнер комплект	CYL. LINER Zylinderlaufbuchse Chemise Camisas de los cilindros втулка цилиндра	PISTON + RINGS Kolben + Ringe Piston + Segments Pistón Set Поршень и кольца			PISTON SET Kolben Set Set de Piston Pistón Set поршневой	RINGS SET Kolben Set Segments de Piston Anillos Set кольца	PIN Pin Axe Perno Пин
<b>JB</b> 4 Cyl 79.5 mm Bore Ø 1,457 cc  		Length:		Length:	77.2	Top:	1.75	Ø: 22.0 Length: 63.4
		Outside Ø:		Comp:	45.2	2nd:	2.0	
		Flange Ø:		Height:	-5.3	3rd:	4.0	
		flange depth				1st oil:	4.0	
			<b>Reference no.:</b>	<b>Reference no.:</b>	<b>Reference no.:</b>	<b>Reference no.:</b>	<b>O-RING</b>	
						A-R40200 G-0840410000 K-800000911000 K-800000941000 M-03459V0 T-50003		
NM-Germany Article no. Artikelnummer/ Modelo Número / статья НОМЕР	NM-Germany Article no.	NM-Germany Article no.	NM-Germany Article no.	NM-Germany Article no.	NM-Germany Article no.	NM-Germany Article no.	NM-Germany Article no.	NM-Germany Article no.
			KBSVW40845G	KBVW40845G	KRVW40845G			

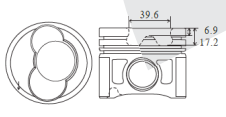

## DIESEL

ENGINE TYPE Motortyp Type de Moteur Tipo de motor Тип двигателя	LINER KIT Liner Kit Kit de Chemise Camisas de los cilindros лайнер комплект	CYL. LINER Zylinderlaufbuchse Chemise Camisas de los cilindros втулка цилиндра	PISTON + RINGS Kolben + Ringe Piston + Segments Pistón Set Поршень и кольца		PISTON SET Kolben Set Set de Piston Pistón Set поршневой	RINGS SET Kolben Set Segments de Piston Anillos Set кольца	PIN Pin Axe Perno Пин
<b>ACV/AGX/AHD/AHY AJT/ANJ/APA/AUF AXG/AYC/AYY/BBE BBF</b> 5 Cyl 81.0 mm Bore Ø 2,461 cc 	<b>(A) M-0305890 consists od (C)</b>  <b>(B) consists od (D)</b>	Length: 158.0 180.0 Outside Ø: 84.0 84.0 Flange Ø: 85.0 87.0 flange depth 5.0 4.7	Length: 69.75 69.5 Comp: 45.75 45.5 Height: -6.9 -6.9 -17.2 -17.2	STD O/S STD O/S	alfin head anodized skirt MOS2 treated pin bushing inserted pin boss gap=27mm	Top: 2.5 2nd: 2.0 3rd: 3.0 1st oil: 3.0 2nd oil:	Ø: 26.0 Length: 68.0
		Reference no.:	Reference no.:	Reference no.:	Reference no.:	O-RING	
		<b>(C) M-029WV25 N-1402042000</b>	<b>K-99742700 M-0305800 N-8750150000</b>		<b>A-R60330 G-0842100000 G-0850150000 K-800001150000 K-800073910000 M-03048N0 M-03490N0</b>		
		<b>(D) K-89586190</b>					
NM-Germany Article no. Artikelnummer/ Modelo Número / статья НОМЕР	NM-Germany Article no.	NM-Germany Article no.	NM-Germany Article no.	NM-Germany Article no.	NM-Germany Article no.	NM-Germany Article no.	NM-Germany Article no.
	LBSVW508481DSA(A) LBSVW508482DSA(B) (for cyl 1/2)	LBVW508481DSA(C) LBVW508482DSA(D)	KBSVW50848DA (for cyl 1/2)	KBVW50848DA (for cyl 1/2)	KRVW50848DA		

## DIESEL

ENGINE TYPE Motortyp Type de Moteur Tipo de motor Тип двигателя	LINER KIT Liner Kit Kit de Chemise Camisas de los cilindros лайнер комплект	CYL. LINER Zylinderlaufbuchse Chemise Camisas de los cilindros втулка цилиндра	PISTON + RINGS Kolben + Ringe Piston + Segments Pistón Set Поршень и кольца		PISTON SET Kolben Set Set de Piston Pistón Set поршневой	RINGS SET Kolben Set Segments de Piston Anillos Set кольца	PIN Pin Axe Perno Пин
<b>ACV/AGX/AHD/AHY AJT/ANJ/APA/AUF AXG/AYC/AYY/BBE BBF</b> 5 Cyl 81.0 mm Bore Ø 2,461 cc 	<b>(A) M-0305990 consists of (C)</b>  <b>(B) consists of (D)</b>	Length: 158.0 180.0 Outside Ø: 84.0 84.0 Flange Ø: 85.0 87.0 flange depth 5.0 4.7	Length: 69.75 69.5 Comp: 45.75 45.5 Height: -6.9 -6.9 -17.2 -17.2	STD O/S STD O/S	alfin head anodized skirt MOS2 treated pin bushing inserted pin boss gap=27mm	Top: 2.5 2nd: 2.0 3rd: 3.0 1st oil: 3.0 2nd oil:	Ø: 26.0 Length: 68.0
		Reference no.:	Reference no.:	Reference no.:	Reference no.:	O-RING	
		<b>(C) M-029WV25 N-1402042000</b>	<b>K-99743700 M-0305900 N-8750150010</b>		<b>A-R60330 G-0842100000 G-0850150000 K-800001150000 K-800073910000 M-03048N0 M-03490N0</b>		
		<b>(D) K-89586190</b>					
NM-Germany Article no. Artikelnummer/ Modelo Número / статья НОМЕР	NM-Germany Article no.	NM-Germany Article no.	NM-Germany Article no.	NM-Germany Article no.	NM-Germany Article no.	NM-Germany Article no.	NM-Germany Article no.
	LBSVW508471DSA(A) LBSVW508472DSA(B)	LBVW508471DSA(C) LBVW508472DSA(D)	KBSVW50847DA	KBVW50847DA	KRVW50847DA		

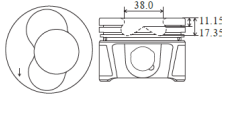
## DIESEL

ENGINE TYPE Motortyp Type de Moteur Tipo de motor Тип двигателя	LINER KIT Liner Kit Kit de Chemise Camisas de los cilindros лайнер комплект	CYL. LINER Zylinderlaufbuchse Chemise Camisas de los cilindros втулка цилиндра	PISTON + RINGS Kolben + Ringe Piston + Segments Pistón Set Поршень и кольца		PISTON SET Kolben Set Set de Piston Pistón Set поршневой	RINGS SET Kolben Set Segments de Piston Anillos Set кольца	PIN Pin Axe Perno Пин
<b>BDJ BDK BST</b> 4 Cyl 81.0 mm Bore Ø 1,968 cc 		Length: 58.3 58.05 Outside Ø: 37.8 37.55 Flange Ø: -11.15 -11.15 flange depth -17.35 -17.35	Length: 58.3 58.05 Comp: 37.8 37.55 Height: -11.15 -11.15 -17.35 -17.35	STD O/S STD O/S	alfin skirt MOS2 treated fits tapered con. rod	Top: 1.75 2nd: 2.0 3rd: 3.0 1st oil: 3.0 2nd oil:	Ø: 22.0 Length: 60.0
		Reference no.:	Reference no.:	Reference no.:	Reference no.:	O-RING	
			<b>K-99833600</b>		<b>G-0813950000 K-800070540000 K-800072710000</b>		
NM-Germany Article no. Artikelnummer/ Modelo Número / статья НОМЕР	NM-Germany Article no.	NM-Germany Article no.	NM-Germany Article no.	NM-Germany Article no.	NM-Germany Article no.	NM-Germany Article no.	NM-Germany Article no.
			KBSVW40848DA	KBVW40848DA	KRVW40848DA		



## DIESEL

ENGINE TYPE	LINER KIT	CYL. LINER	PISTON + RINGS		PISTON SET	RINGS SET	PIN	
Motor typ Type de Moteur Tipo de motor Тип двигателя	Liner Kit Kit de Chemise Camisas de los cilindros лайнер комплект	Zylinderlaufbuchse Chemise Camisas de los cilindros втулка цилиндра		STD O/S	Kolben Set Set de Piston Pistón Set поршневой	Kolben Set Segments de Piston Anillos Set кольца	Pin Axe Perno Пин	
<b>BDJ BDK BST</b> 4 Cyl 81.0 mm Bore Ø 1,968 cc		Length: Outside Ø: Flange Ø: flange depth	Length:	58.3 58.05	alfin skirt MOS2 treated fits tapered con. rod	Top:	1.75	Ø: 22.0 Length: 60.0
			Comp:	37.8 37.55		2nd:	2.0	
			Height:	-11.15 -11.15		3rd:	3.0	
				-17.35 -17.35		1st oil:		
			Reference no.:	Reference no.:	Reference no.:	Reference no.:	O-RING	
				<b>K-99832600</b>		<b>G-0813950000 K-800070540000 K-800072710000</b>		
NM-Germany Article no. Artikelnummer/ Modelo Número / статья НОМЕР	NM-Germany Article no.	NM-Germany Article no.	NM-Germany Article no.	NM-Germany Article no.	NM-Germany Article no.	NM-Germany Article no.	NM-Germany Article no.	
			<b>KBSVW40849DA</b>	<b>KBVW40849DA</b>	<b>KRVW40849DA</b>			

VW



## DIESEL

ENGINE TYPE	LINER KIT	CYL. LINER	PISTON + RINGS		PISTON SET	RINGS SET	PIN	
Motor typ Type de Moteur Tipo de motor Тип двигателя	Liner Kit Kit de Chemise Camisas de los cilindros лайнер комплект	Zylinderlaufbuchse Chemise Camisas de los cilindros втулка цилиндра		STD O/S	Kolben Set Set de Piston Pistón Set поршневой	Kolben Set Segments de Piston Anillos Set кольца	Pin Axe Perno Пин	
<b>AZV BKD</b> 4 Cyl 81.0 mm Bore Ø 1,968 cc		Length: Outside Ø: Flange Ø: flange depth	Length:	68.8 68.5	alfin and with oil gallery skirt MOS2 treated pin bushing inserted fits tapered con. rod	Top:	1.75	Ø: 26.0 Length: 66.0
			Comp:	45.8 45.5		2nd:	2.0	
			Height:	-10.5 -10.5		3rd:	3.0	
				-18.0 -18.0		1st oil:		
			Reference no.:	Reference no.:	Reference no.:	Reference no.:	O-RING	
				<b>K-40356600</b>		<b>G-0813950000 K-800070540000 K-800072710000</b>		
NM-Germany Article no. Artikelnummer/ Modelo Número / статья НОМЕР	NM-Germany Article no.	NM-Germany Article no.	NM-Germany Article no.	NM-Germany Article no.	NM-Germany Article no.	NM-Germany Article no.	NM-Germany Article no.	
			<b>KBSVW40850DB</b>	<b>KBVW40850DB</b>	<b>KRVW40850DB</b>			

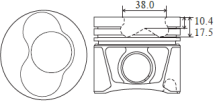

## DIESEL

ENGINE TYPE	LINER KIT	CYL. LINER	PISTON + RINGS		PISTON SET	RINGS SET	PIN	
Motor typ Type de Moteur Tipo de motor Тип двигателя	Liner Kit Kit de Chemise Camisas de los cilindros лайнер комплект	Zylinderlaufbuchse Chemise Camisas de los cilindros втулка цилиндра		STD O/S	Kolben Set Set de Piston Pistón Set поршневой	Kolben Set Segments de Piston Anillos Set кольца	Pin Axe Perno Пин	
<b>BMM/BMP BSS/BWW</b> 4 Cyl 81.0 mm Bore Ø 1,968 cc		Length: Outside Ø: Flange Ø: flange depth	Length:	68.8 68.55	alfin and with oil gallery skirt MOS2 treated pin bushing inserted fits tapered con. rod	Top:	1.75	Ø: 26.0 Length: 66.0
			Comp:	45.8 45.55		2nd:	2.0	
			Height:	-10.4 -10.4		3rd:	3.0	
				-17.5 -17.5		1st oil:		
			Reference no.:	Reference no.:	Reference no.:	Reference no.:	O-RING	
				<b>K-40408600 M-0280600</b>		<b>G-0813950000 K-800070540000 K-800072710000</b>		
NM-Germany Article no. Artikelnummer/ Modelo Número / статья НОМЕР	NM-Germany Article no.	NM-Germany Article no.	NM-Germany Article no.	NM-Germany Article no.	NM-Germany Article no.	NM-Germany Article no.	NM-Germany Article no.	
			<b>KBSVW40851DB</b>	<b>KBSVW40851DB (for cyl 1/2)</b>	<b>KRVW40851D</b>			

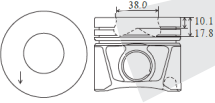

**DIESEL**

ENGINE TYPE Motortyp Type de Moteur Tipo de motor Тип двигателя	LINER KIT Liner Kit Kit de Chemise Camisas de los cilindros лайнер комплект	CYL. LINER Zylinderlaufbuchse Chemise Camisas de los cilindros втулка цилиндра	PISTON + RINGS Kolben + Ringe Piston + Segments Pistón Set Поршень и кольца		PISTON SET Kolben Set Set de Piston Pistón Set поршень	RINGS SET Kolben Set Segments de Piston Anillos Set кольца	PIN Pin Axe Perno Пин		
<b>BMM/BMP BSS/BWW</b>  4 Cyl 81.0 mm Bore Ø 1,968 cc  		Length: Outside Ø: Flange Ø: flange depth	STD	O/S	alfin and with oil gallery skirt MOS2 treated pin bushing inserted fits tapered con. rod	Top: 1.75 2nd: 2.0 3rd: 3.0 1st oil: 3.0 2nd oil:	Ø: 26.0  Length: 66.0		
			Length: 68.8	68.55		Comp: 45.8	45.55	Height: -10.4	-10.4
			Reference no.:			Reference no.:		Reference no.:	Reference no.:
		<b>K-40409600 M-0280700</b>			<b>G-0813950000 K-800070540000 K-800072710000</b>				
NM-Germany Article no. Artikelnummer/ Modelo Número / статья НОМЕР	NM-Germany Article no.	NM-Germany Article no.	NM-Germany Article no.	NM-Germany Article no.	NM-Germany Article no.	NM-Germany Article no.	NM-Germany Article no.		
			<b>KBSVW40852DB</b>	(for cyl 3/4)	<b>KBVW40852DB</b>				

**DIESEL**

ENGINE TYPE Motortyp Type de Moteur Tipo de motor Тип двигателя	LINER KIT Liner Kit Kit de Chemise Camisas de los cilindros лайнер комплект	CYL. LINER Zylinderlaufbuchse Chemise Camisas de los cilindros втулка цилиндра	PISTON + RINGS Kolben + Ringe Piston + Segments Pistón Set Поршень и кольца		PISTON SET Kolben Set Set de Piston Pistón Set поршень	RINGS SET Kolben Set Segments de Piston Anillos Set кольца	PIN Pin Axe Perno Пин		
<b>AZV/BKD/BKP BMA/BMN/BMR BUZ/BVE/BWV</b>  4 Cyl 81.0 mm Bore Ø 1,968 cc  		Length: Outside Ø: Flange Ø: flange depth	STD	0.50	alfin and with oil gallery skirt MOS2 treated pin bushing inserted fits tapered con. rod	Top: 1.75 2nd: 2.0 3rd: 3.0 1st oil: 3.0 2nd oil:	Ø: 26.0  Length: 66.0		
			Length: 68.8	68.55		Comp: 45.8	45.55	Height: -10.1	-10.1
			Length: 68.8	68.55		Comp: 45.8	45.55	Height: -10.1	-10.1
		Reference no.:		Reference no.:	Reference no.:	Reference no.:	O-RING		
		<b>K-40387600 N-8713950000</b>			<b>G-0813950000 K-800070540000 K-800072710000</b>				
NM-Germany Article no. Artikelnummer/ Modelo Número / статья НОМЕР	NM-Germany Article no.	NM-Germany Article no.	NM-Germany Article no.	NM-Germany Article no.	NM-Germany Article no.	NM-Germany Article no.	NM-Germany Article no.		
			<b>KBSVW40853DB</b>	<b>KBVW40853DB</b>	<b>KRVW40853DB</b>				

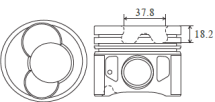
**DIESEL**

ENGINE TYPE Motortyp Type de Moteur Tipo de motor Тип двигателя	LINER KIT Liner Kit Kit de Chemise Camisas de los cilindros лайнер комплект	CYL. LINER Zylinderlaufbuchse Chemise Camisas de los cilindros втулка цилиндра	PISTON + RINGS Kolben + Ringe Piston + Segments Pistón Set Поршень и кольца		PISTON SET Kolben Set Set de Piston Pistón Set поршень	RINGS SET Kolben Set Segments de Piston Anillos Set кольца	PIN Pin Axe Perno Пин
<b>AXD/AXE TURBO BAC/BLJ/BLK TURBO</b>  5 Cyl 81.0 mm Bore Ø 2,461 cc 2,498 cc  	<b>M-0309790</b>	Length: 158.0 Outside Ø: 84.0 Flange Ø: 85.0 flange depth 5.0	Length: 69.75		alfin and with oil gallery pin bushing inserted fits tapered con. rod	Top: 2.5 2nd: 2.0 3rd: 3.0 1st oil: 3.0 2nd oil:	Ø: 26.0  Length: 65.0
			Comp: 45.75			Height: -18.2	
			Reference no.:			Reference no.:	
		<b>M-029WV25 N-1402042000</b>		<b>M-0309700 N-8742100010</b>		<b>A-R60330 G-0842100000 G-0850150000 K-800001150000 K-800073910000 M-03048N0 M-03490N0</b>	
NM-Germany Article no. Artikelnummer/ Modelo Número / статья НОМЕР	NM-Germany Article no.	NM-Germany Article no.	NM-Germany Article no.	NM-Germany Article no.	NM-Germany Article no.	NM-Germany Article no.	NM-Germany Article no.
	<b>LBSVW50854DSB</b> (for cyl 1/2)	<b>LBVW50854DSB</b>	<b>KBSVW50854DB</b> (for cyl 1/2)	<b>KBVW50854DB</b> (for cyl 1/2)	<b>KRVW50854DB</b>		

**DIESEL**

ENGINE TYPE Motortyp Type de Moteur Tipo de motor Тип двигателя	LINER KIT Liner Kit Kit de Chemise Camisas de los cilindros лайнер комплект	CYL. LINER Zylinderlaufbuchse Chemise Camisas de los cilindros втулка цилиндра	PISTON + RINGS Kolben + Ringe Piston + Segments Pistón Set Поршень и кольца		PISTON SET Kolben Set Set de Piston Pistón Set поршневой	RINGS SET Kolben Set Segments de Piston Anillos Set кольца	PIN Pin Axe Perno Пин					
<b>AXD/AXE TURBO BAC/BLJ/BLK TURBO</b>	<b>M-0309890</b>	Length: 158.0 Outside Ø: 84.0 Flange Ø: 85.0 flange depth 5.0	Length: 69.75 Comp: 45.75 Height: -18.2		alfin and with oil gallery pin bushing inserted fits tapered con. rod	Top: 2.5 2nd: 2.0 3rd: 3.0 1st oil: 2nd oil: 3.0	Ø: 26.0 Length: 65.0					
								Reference no.:	Reference no.:	Reference no.:	Reference no.:	O-RING
								<b>M-029WV25 N-1402042000</b>	<b>M-0309800 N-8742100020</b>		<b>A-R60330 G-0842100000 G-0850150000 K-800001150000 K-800073910000 M-03048N0 M-03490N0</b>	
NM-Germany Article no. Artikelnummer/ Modelo Número / статья НОМЕР	NM-Germany Article no.	NM-Germany Article no.	NM-Germany Article no.	NM-Germany Article no.	NM-Germany Article no.	NM-Germany Article no.	NM-Germany Article no.					
	<b>LBSVW5085DSB (for cyl 3/4/5)</b>	<b>LBVW5085DSB</b>	<b>KBSVW50855DB (for cyl 3/4/5)</b>	<b>KBVW50855DB (for cyl 3/4/5)</b>	<b>KRVW50855DB</b>							

VW

**DIESEL**

ENGINE TYPE Motortyp Type de Moteur Tipo de motor Тип двигателя	LINER KIT Liner Kit Kit de Chemise Camisas de los cilindros лайнер комплект	CYL. LINER Zylinderlaufbuchse Chemise Camisas de los cilindros втулка цилиндра	PISTON + RINGS Kolben + Ringe Piston + Segments Pistón Set Поршень и кольца		PISTON SET Kolben Set Set de Piston Pistón Set поршневой	RINGS SET Kolben Set Segments de Piston Anillos Set кольца	PIN Pin Axe Perno Пин					
<b>CBBB/CBDA CBDB/CBDC CEGA</b>		Length: 158.0 Outside Ø: 84.0 Flange Ø: 85.0 flange depth 5.0	Length: 68.8 Comp: 45.8 Height: -7.9 -12.7		alfin and with oil gallery skirt MOS2 treated pin bushing inserted fits tapered con. rod	Top: 1.75 2nd: 2.0 3rd: 3.0 1st oil: 2nd oil: 3.0	Ø: 26.0 Length: 66.0					
								Reference no.:	Reference no.:	Reference no.:	Reference no.:	O-RING
									<b>K-40558600</b>		<b>G-0813950000 K-800070540000 K-800072710000</b>	
NM-Germany Article no. Artikelnummer/ Modelo Número / статья НОМЕР	NM-Germany Article no.	NM-Germany Article no.	NM-Germany Article no.	NM-Germany Article no.	NM-Germany Article no.	NM-Germany Article no.	NM-Germany Article no.					
			<b>KBSVW40856DB</b>	<b>KBVW40856DB</b>	<b>KRVW40856DB</b>							

**DIESEL**

ENGINE TYPE Motortyp Type de Moteur Tipo de motor Тип двигателя	LINER KIT Liner Kit Kit de Chemise Camisas de los cilindros лайнер комплект	CYL. LINER Zylinderlaufbuchse Chemise Camisas de los cilindros втулка цилиндра	PISTON + RINGS Kolben + Ringe Piston + Segments Pistón Set Поршень и кольца		PISTON SET Kolben Set Set de Piston Pistón Set поршневой	RINGS SET Kolben Set Segments de Piston Anillos Set кольца	PIN Pin Axe Perno Пин					
<b>AVR/BBR</b>		Length: 45.75 Outside Ø: Flange Ø: flange depth	Length: -16.8 Comp: 69.5 Height: 45.5 -16.8	STD O/S	alfin pin bushing inserted	Top: 2.5 2nd: 2.0 3rd: 3.0 1st oil: 2nd oil: 3.0	Ø: 26.0 Length: 68.0					
								Reference no.:	Reference no.:	Reference no.:	Reference no.:	O-RING
									<b>K-40734600 M-0308800 N-8750150040</b>	<b>074 107 065R</b>	<b>A-R60330 G-0842100000 G-0850150000 K-800001150000 K-800073910000 M-03048N0 M-03490N0</b>	
NM-Germany Article no. Artikelnummer/ Modelo Número / статья НОМЕР	NM-Germany Article no.	NM-Germany Article no.	NM-Germany Article no.	NM-Germany Article no.	NM-Germany Article no.	NM-Germany Article no.	NM-Germany Article no.					
			<b>KBSVW50857DA</b>	<b>KBVW50857DA</b>	<b>KRVW50857DA</b>							

**GASOLINE**

ENGINE TYPE Motortyp Type de Moteur Tipo de motor Тип двигателя	LINER KIT Liner Kit Kit de Chemise Camisas de los cilindros лайнер комплект	CYL. LINER Zylinderlaufbuchse Chemise Camisas de los cilindros втулка цилиндра	PISTON + RINGS Kolben + Ringe Piston + Segments Pistón Set Поршень и кольца		PISTON SET Kolben Set Set de Piston Pistón Set поршневой	RINGS SET Kolben Set Segments de Piston Anillos Set кольца	PIN Pin Axe Perno Пин
<b>EZ/HM HP/JS</b> 4/5 Cyl 81.0 mm Bore Ø 1,595 cc 1,994 cc		Length: Outside Ø: Flange Ø: flange depth	Length:	STD	O/S	Top: 1.5 2nd: 1.75 3rd: 1st oil: 3.0 2nd oil:	Ø: 20.0 Length: 57.0
			Length:	66.8	66.5		
			Comp:	35.6	35.3		
		Height:	2.2	2.2			
		Reference no.:	Reference no.:	Reference no.:	Reference no.:	O-RING	
			<b>K-93871600 M-0345300</b>		<b>A-R60300 G-0850190000 K-800001011000 M-03475N0</b>		
NM-Germany Article no. Artikelnummer/ Modelo Número / статья НОМЕР	NM-Germany Article no.	NM-Germany Article no.	NM-Germany Article no.	NM-Germany Article no.	NM-Germany Article no.	NM-Germany Article no.	
			<b>KBSVW450858G KBSVW450858G</b>	<b>KBVW450858G KBVW450858G</b>	<b>KRVW450858G KRVW450858G</b>		

**GASOLINE**

ENGINE TYPE Motortyp Type de Moteur Tipo de motor Тип двигателя	LINER KIT Liner Kit Kit de Chemise Camisas de los cilindros лайнер комплект	CYL. LINER Zylinderlaufbuchse Chemise Camisas de los cilindros втулка цилиндра	PISTON + RINGS Kolben + Ringe Piston + Segments Pistón Set Поршень и кольца		PISTON SET Kolben Set Set de Piston Pistón Set поршневой	RINGS SET Kolben Set Segments de Piston Anillos Set кольца	PIN Pin Axe Perno Пин
<b>EV</b> 4 Cyl 81.0 mm Bore Ø 1,781 cc		Length: Outside Ø: Flange Ø: flange depth	Length:	62.5		Top: 1.5 2nd: 1.75 3rd: 1st oil: 3.0 2nd oil:	Ø: 20.0 Length: 57.0
			Length:	32.2			
			Comp:	1.3			
		Height:	-4.4				
		Reference no.:	Reference no.:	Reference no.:	Reference no.:	O-RING	
					<b>A-R60300 G-0850190000 K-800001011000 M-03475N0</b>		
NM-Germany Article no. Artikelnummer/ Modelo Número / статья НОМЕР	NM-Germany Article no.	NM-Germany Article no.	NM-Germany Article no.	NM-Germany Article no.	NM-Germany Article no.	NM-Germany Article no.	
			<b>KBSVW40859G</b>	<b>KBVW40859G</b>	<b>KRVW40859G</b>		

**GASOLINE**

ENGINE TYPE Motortyp Type de Moteur Tipo de motor Тип двигателя	LINER KIT Liner Kit Kit de Chemise Camisas de los cilindros лайнер комплект	CYL. LINER Zylinderlaufbuchse Chemise Camisas de los cilindros втулка цилиндра	PISTON + RINGS Kolben + Ringe Piston + Segments Pistón Set Поршень и кольца		PISTON SET Kolben Set Set de Piston Pistón Set поршневой	RINGS SET Kolben Set Segments de Piston Anillos Set кольца	PIN Pin Axe Perno Пин
<b>KR PL</b> 4 Cyl 81.0 mm Bore Ø 1,781 cc		Length: Outside Ø: Flange Ø: flange depth	Length:	STD	O/S	Top: 1.5 2nd: 1.75 3rd: 1st oil: 3.0 2nd oil:	Ø: 20.0 Length: 57.0
			Length:	63.0	62.7		
			Comp:	33.4	33.1		
		Height:	0.6	0.6			
		flange depth	-3.4	-3.4			
		Reference no.:	Reference no.:	Reference no.:	Reference no.:	O-RING	
			<b>K-93117600 M-0348100 N-8710940010</b>		<b>A-R60300 G-0850190000 K-800001011000 M-03475N0</b>		
NM-Germany Article no. Artikelnummer/ Modelo Número / статья НОМЕР	NM-Germany Article no.	NM-Germany Article no.	NM-Germany Article no.	NM-Germany Article no.	NM-Germany Article no.	NM-Germany Article no.	
			<b>KBSVW40860G</b>	<b>KBVW40860G</b>	<b>KRVW40860G</b>		



**GASOLINE**

ENGINE TYPE Motortyp Type de Moteur Tipo de motor Тип двигателя	LINER KIT Liner Kit Kit de Chemise Camisas de los cilindros лайнер комплект	CYL. LINER Zylinderlaufbuchse Chemise Camisas de los cilindros втулка цилиндра	PISTON + RINGS Kolben + Ringe Piston + Segments Pistón Set Поршень и кольца		PISTON SET Kolben Set Set de Piston Pistón Set поршневой	RINGS SET Kolben Set Segments de Piston Anillos Set кольца	PIN Pin Axe Perno Пин
<b>1F/ABN/DT EW/EZ/EZA JU/PN/RE/RL</b> 4 Cyl 81.0 mm Bore Ø 1,595 cc		Length: Outside Ø: Flange Ø: flange depth	STD	O/S		Top: 1.5 2nd: 1.75 3rd: 3.0 1st oil: 3.0 2nd oil:	Ø: 20.0 Length: 57.0
			Length: 66.8	66.5			
			Comp: 35.6	35.3			
		Height: +2.2	+2.2				
			-2.3	-2.3			
		Reference no.:	Reference no.:	Reference no.:	Reference no.:	O-RING	
			<b>K-93872600 M-0347600</b>		<b>A-R60300 G-0850190000 K-800001011000 M-03475N0</b>		
NM-Germany Article no. Artikelnummer/ Modelo Número / статья НОМЕР	NM-Germany Article no.	NM-Germany Article no.	NM-Germany Article no.	NM-Germany Article no.	NM-Germany Article no.	NM-Germany Article no.	NM-Germany Article no.
			<b>KBSVW40864G</b>	<b>KBVW40864G</b>	<b>KRVW40864G</b>		

**GASOLINE**

ENGINE TYPE Motortyp Type de Moteur Tipo de motor Тип двигателя	LINER KIT Liner Kit Kit de Chemise Camisas de los cilindros лайнер комплект	CYL. LINER Zylinderlaufbuchse Chemise Camisas de los cilindros втулка цилиндра	PISTON + RINGS Kolben + Ringe Piston + Segments Pistón Set Поршень и кольца		PISTON SET Kolben Set Set de Piston Pistón Set поршневой	RINGS SET Kolben Set Segments de Piston Anillos Set кольца	PIN Pin Axe Perno Пин
<b>AAC AAF/AEU</b> 4/5 Cyl 81.0 mm Bore Ø 1,998 cc 2,461 cc		Length: Outside Ø: Flange Ø: flange depth	Length: 65.4			Top: 1.75 2nd: 2.0 3rd: 3.0 1st oil: 3.0 2nd oil:	Ø: 24.0 Length: 56.0
			Comp: 38.4				
			Height: 1.1	-10.5			
		Reference no.:	Reference no.:	Reference no.:	Reference no.:	O-RING	
			<b>K-90942600 M-0299000</b>		<b>K-800026410000 M-02990N0</b>		
NM-Germany Article no. Artikelnummer/ Modelo Número / статья НОМЕР	NM-Germany Article no.	NM-Germany Article no.	NM-Germany Article no.	NM-Germany Article no.	NM-Germany Article no.	NM-Germany Article no.	NM-Germany Article no.
			<b>KBSVW450865G</b>	<b>KBVW450865G</b>	<b>KRVW450865G</b>		

**GASOLINE**

ENGINE TYPE Motortyp Type de Moteur Tipo de motor Тип двигателя	LINER KIT Liner Kit Kit de Chemise Camisas de los cilindros лайнер комплект	CYL. LINER Zylinderlaufbuchse Chemise Camisas de los cilindros втулка цилиндра	PISTON + RINGS Kolben + Ringe Piston + Segments Pistón Set Поршень и кольца		PISTON SET Kolben Set Set de Piston Pistón Set поршневой	RINGS SET Kolben Set Segments de Piston Anillos Set кольца	PIN Pin Axe Perno Пин
<b>ADR/AGN APT/ARG</b> 4 Cyl 81.0 mm Bore Ø 1,781 cc		Length: Outside Ø: Flange Ø: flange depth	STD	0.50		Top: 1.5 2nd: 1.75 3rd: 2.0 1st oil: 2.0 2nd oil:	Ø: 20.0 Length: 59.0
			0.25	1.00			
			Length: 56.8	56.5			
		Comp: 32.6	32.3				
		Height: -2.5	-2.5				
		Reference no.:	Reference no.:	Reference no.:	Reference no.:	O-RING	
			<b>K-99559600 M-0331300 N-8750290000</b>	<b>058 107 065 J 058 107 065 M</b>	<b>058 191 151 B A-R60320 G-0850290000 K-800045040000 M-03304N0 T-50017</b>		
NM-Germany Article no. Artikelnummer/ Modelo Número / статья НОМЕР	NM-Germany Article no.	NM-Germany Article no.	NM-Germany Article no.	NM-Germany Article no.	NM-Germany Article no.	NM-Germany Article no.	NM-Germany Article no.
			<b>KBSVW40866G</b>	<b>KBVW40866G</b>	<b>KRVW40866G</b>		

## GASOLINE

ENGINE TYPE Motortyp Type de Moteur Tipo de motor Тип двигателя	LINER KIT Liner Kit Kit de Chemise Camisas de los cilindros лайнер комплект	CYL. LINER Zylinderlaufbuchse Chemise Camisas de los cilindros втулка цилиндра	PISTON + RINGS Kolben + Ringe Piston + Segments Pistón Set Поршень и кольца		PISTON SET Kolben Set Set de Piston Pistón Set поршневой	RINGS SET Kolben Set Segments de Piston Anillos Set кольца	PIN Pin Axe Perno Пин		
<b>ADP/AEK/AFT AHL/AKL/ARM</b> 4 Cyl 81.0 mm Bore Ø 1,595 cc		Length:	Length:	STD	O/S	skirt MOS2 treated	Top:	1.2	Ø: 20.0 Length: 57.0
		Outside Ø:	Length:	53.8	53.5		2nd:	1.5	
		Flange Ø:	Comp:	32.0	31.7		3rd:	2.0	
		flange depth	Height:	+0.7	+0.7	1st oil:	2.0	2nd oil:	
				-2.3	-2.3				
		Reference no.:	Reference no.:	Reference no.:	Reference no.:	O-RING			
			<b>K-94503700 M-0330100 N-8710590000</b>			<b>A-R60290 G-0810590000 K-8000039440000 M-03301N0</b>			
NM-Germany Article no. Artikelnummer/ Modelo Número / статья НОМЕР	NM-Germany Article no.	NM-Germany Article no.	NM-Germany Article no.	NM-Germany Article no.	NM-Germany Article no.	NM-Germany Article no.	NM-Germany Article no.		
			<b>KBSVW40867G</b>	<b>KBVW40867G</b>	<b>KRVW40867G</b>				



## GASOLINE

ENGINE TYPE Motortyp Type de Moteur Tipo de motor Тип двигателя	LINER KIT Liner Kit Kit de Chemise Camisas de los cilindros лайнер комплект	CYL. LINER Zylinderlaufbuchse Chemise Camisas de los cilindros втулка цилиндра	PISTON + RINGS Kolben + Ringe Piston + Segments Pistón Set Поршень и кольца		PISTON SET Kolben Set Set de Piston Pistón Set поршневой	RINGS SET Kolben Set Segments de Piston Anillos Set кольца	PIN Pin Axe Perno Пин		
<b>1P/ABS/ADZ/DX EV/GX/HT/JV/KT PF/RG</b> 4 Cyl 81.0 mm Bore Ø 1,781 cc		Length:	Length:	STD	O/S	skirt MOS2 treated	Top:	1.5	Ø: 20.0 Length: 57.0
		Outside Ø:	Length:	62.5	62.2		2nd:	1.75	
		Flange Ø:	Comp:	32.2	31.9		3rd:	3.0	
		flange depth	Height:	+1.3	+1.3	1st oil:	3.0	2nd oil:	
				-4.4	-4.4				
		Reference no.:	Reference no.:	Reference no.:	Reference no.:	O-RING			
			<b>K-93928600 M-0347500 N-8710940040 N-8710940050</b>			<b>A-R60300 G-0850190000 K-800001011000 M-03475N0</b>			
NM-Germany Article no. Artikelnummer/ Modelo Número / статья НОМЕР	NM-Germany Article no.	NM-Germany Article no.	NM-Germany Article no.	NM-Germany Article no.	NM-Germany Article no.	NM-Germany Article no.	NM-Germany Article no.		
			<b>KBSVW40868G</b>	<b>KBVW40868G</b>	<b>KRVW40868G</b>				

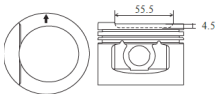

## DIESEL

ENGINE TYPE Motortyp Type de Moteur Tipo de motor Тип двигателя	LINER KIT Liner Kit Kit de Chemise Camisas de los cilindros лайнер комплект	CYL. LINER Zylinderlaufbuchse Chemise Camisas de los cilindros втулка цилиндра	PISTON + RINGS Kolben + Ringe Piston + Segments Pistón Set Поршень и кольца		PISTON SET Kolben Set Set de Piston Pistón Set поршневой	RINGS SET Kolben Set Segments de Piston Anillos Set кольца	PIN Pin Axe Perno Пин		
<b>AEB/AGU/AJH ANB/APH/APU ARZ/AVC/AWC</b> 4 Cyl 81.0 mm Bore Ø 1,781 cc		Length:	Length:	STD	O/S	skirt MOS2 treated	Top:	1.5	Ø: 20.0 Length: 59.0
		Outside Ø:	Length:	53.7	53.4		2nd:	1.75	
		Flange Ø:	Comp:	32.7	32.4		3rd:	2.0	
		flange depth	Height:	-1.4	-1.4	1st oil:	2.0	2nd oil:	
		Reference no.:	Reference no.:	Reference no.:	Reference no.:	O-RING			
			<b>K-99933600 M-0330400 N-8750290010</b>	<b>058 107 065 F</b>		<b>058 198 151 B A-R60320 G-0850290000 K-800045040000 M-03304N0 T-50017</b>			
NM-Germany Article no. Artikelnummer/ Modelo Número / статья НОМЕР	NM-Germany Article no.	NM-Germany Article no.	NM-Germany Article no.	NM-Germany Article no.	NM-Germany Article no.	NM-Germany Article no.	NM-Germany Article no.		
			<b>KBSVW40869D</b>	<b>KBVW40869D</b>	<b>KRVW40869D</b>				

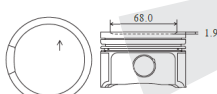

**GASOLINE**

ENGINE TYPE Motortyp Type de Moteur Tipo de motor Тип двигателя	LINER KIT Liner Kit Kit de Chemise Camisas de los cilindros лайнер комплект	CYL. LINER Zylinderlaufbuchse Chemise Camisas de los cilindros втулка цилиндра	PISTON + RINGS Kolben + Ringe Piston + Segments Pistón Set Поршень и кольца		PISTON SET Kolben Set Set de Piston Pistón Set поршневой	RINGS SET Kolben Set Segments de Piston Anillos Set кольца	PIN Pin Axe Perno Пин
<b>KV</b> 5 Cyl 81.0 mm Bore Ø 2,226 cc 		Length: Outside Ø: Flange Ø: flange depth	STD	O/S		Top: 1.5 2nd: 1.75 3rd: 3.0 1st oil: 2nd oil:	Ø: 20.0 Length: 56.5
			Length: 62.3	62.0			
			Comp: 32.2	31.9			
			Height: 1.1	1.1			
			-4.5	-4.5			
			Reference no.:	Reference no.:	Reference no.:	Reference no.:	O-RING
			<b>K-93825600</b> <b>M-0347400</b> <b>N-8710970030</b>			<b>G-0850190000</b> <b>K-800001011000</b> <b>M-03475N0</b>	
NM-Germany Article no. Artikelnummer/ Modelo Número / статья НОМЕР	NM-Germany Article no.	NM-Germany Article no.	NM-Germany Article no.	NM-Germany Article no.	NM-Germany Article no.	NM-Germany Article no.	NM-Germany Article no.
			<b>KBSVW50870G</b>	<b>KBVW50870G</b>	<b>KRVW50870G</b>		

**GASOLINE**

ENGINE TYPE Motortyp Type de Moteur Tipo de motor Тип двигателя	LINER KIT Liner Kit Kit de Chemise Camisas de los cilindros лайнер комплект	CYL. LINER Zylinderlaufbuchse Chemise Camisas de los cilindros втулка цилиндра	PISTON + RINGS Kolben + Ringe Piston + Segments Pistón Set Поршень и кольца		PISTON SET Kolben Set Set de Piston Pistón Set поршневой	RINGS SET Kolben Set Segments de Piston Anillos Set кольца	PIN Pin Axe Perno Пин
<b>ARX/AUM TURBO</b> <b>AUQ/AWM TURBO</b> <b>AWT/AWU TURBO</b> 4 Cyl 81.0 mm Bore Ø 1,781 cc 		Length: Outside Ø: Flange Ø: flange depth	STD	0.50 0.25	top and 2nd ring lands anodized skirt MOS2 treated fits tapered con. rod	Top: 1.5 2nd: 1.75 3rd: 2.0 1st oil: 2nd oil:	Ø: 19.0 Length: 50.0
			Length: 53.7	53.4			
			Comp: 32.7	32.4			
			Height: -1.9	-1.9			
			Reference no.:	Reference no.:	Reference no.:	Reference no.:	O-RING
			<b>K-40434600</b> <b>M-0331600</b>		<b>06B 107 065 N</b>	<b>058 198 151 B</b> <b>A-R60320</b> <b>G-0850290000</b> <b>K-800045040000</b> <b>M-03304N0</b> <b>T-50017</b>	
NM-Germany Article no. Artikelnummer/ Modelo Número / статья НОМЕР	NM-Germany Article no.	NM-Germany Article no.	NM-Germany Article no.	NM-Germany Article no.	NM-Germany Article no.	NM-Germany Article no.	NM-Germany Article no.
			<b>KBSVW40871G</b>	<b>KBVW40871G</b>	<b>KRVW40871G</b>		

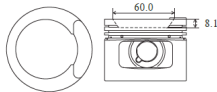
**GASOLINE**

ENGINE TYPE Motortyp Type de Moteur Tipo de motor Тип двигателя	LINER KIT Liner Kit Kit de Chemise Camisas de los cilindros лайнер комплект	CYL. LINER Zylinderlaufbuchse Chemise Camisas de los cilindros втулка цилиндра	PISTON + RINGS Kolben + Ringe Piston + Segments Pistón Set Поршень и кольца		PISTON SET Kolben Set Set de Piston Pistón Set поршневой	RINGS SET Kolben Set Segments de Piston Anillos Set кольца	PIN Pin Axe Perno Пин
<b>JT</b> <b>KM</b> <b>KX</b> 5 Cyl 81.0 mm Bore Ø 2,226 cc 		Length: Outside Ø: Flange Ø: flange depth	STD	O/S		Top: 1.5 2nd: 1.75 3rd: 3.0 1st oil: 2nd oil:	Ø: 20.0 Length: 57.0
			Length: 62.3	62.0			
			Comp: 32.2	31.9			
			Height: 1.1	1.1			
			-8.1	-8.1			
			Reference no.:	Reference no.:	Reference no.:	Reference no.:	O-RING
			<b>K-93874600</b> <b>M-0347900</b> <b>N-8710970000</b>			<b>A-R60300</b> <b>G-0850190000</b> <b>K-800001011000</b> <b>M-03475N0</b>	
NM-Germany Article no. Artikelnummer/ Modelo Número / статья НОМЕР	NM-Germany Article no.	NM-Germany Article no.	NM-Germany Article no.	NM-Germany Article no.	NM-Germany Article no.	NM-Germany Article no.	NM-Germany Article no.
			<b>KBSVW50872G</b>	<b>KBVW50872G</b>	<b>KRVW50872G</b>		



ENGINE TYPE Motortyp Type de Moteur Tipo de motor Тип двигателя	LINER KIT Liner Kit Kit de Chemise Camisas de los cilindros лайнер комплект	CYL. LINER Zylinderlaufbuchse Chemise Camisas de los cilindros втулка цилиндра	PISTON + RINGS Kolben + Ringe Piston + Segments Pistón Set Поршень и кольца			PISTON SET Kolben Set Set de Piston Pistón Set поршневой	RINGS SET Kolben Set Segments de Piston Anillos Set кольца	PIN Pin Axe Perno Пин				
<b>ACC ADD</b> 4 Cyl 81.0 mm Bore Ø 1,781 cc		Length: Outside Ø: Flange Ø: flange depth	Length: Comp: Height:	62.44 32.34 1.12		Top: 1.5 2nd: 1.75 3rd: 3.0 1st oil: 2nd oil:	Ø: 20.0 Length: 57.0					
								Reference no.:	Reference no.:	Reference no.:	Reference no.:	O-RING
											<b>A-R60300 G-0850190000 K-800001011000 M-03475N0</b>	
NM-Germany Article no. Artikelnummer/ Modelo Número / статья НОМЕР	NM-Germany Article no.	NM-Germany Article no.	NM-Germany Article no.	NM-Germany Article no.	NM-Germany Article no.	NM-Germany Article no.	NM-Germany Article no.					
			<b>KBSVW40873G</b>	<b>KBVW40873G</b>	<b>KRVW40873G</b>							

VW

ENGINE TYPE Motortyp Type de Moteur Tipo de motor Тип двигателя	LINER KIT Liner Kit Kit de Chemise Camisas de los cilindros лайнер комплект	CYL. LINER Zylinderlaufbuchse Chemise Camisas de los cilindros втулка цилиндра	PISTON + RINGS Kolben + Ringe Piston + Segments Pistón Set Поршень и кольца			PISTON SET Kolben Set Set de Piston Pistón Set поршневой	RINGS SET Kolben Set Segments de Piston Anillos Set кольца	PIN Pin Axe Perno Пин
<b>AP 800</b> 4 Cyl 81.0 mm Bore Ø 1,781 cc		Length: Outside Ø: Flange Ø: flange depth	Length: Comp: Height:	STD	O/S	Top: 1.5 2nd: 1.75 3rd: 3.0 1st oil: 2nd oil:	Ø: 20.0 Length: 57.0	
				61.63	61.33			
				32.63	32.33			
				0	0			
		Reference no.:	Reference no.:	Reference no.:	Reference no.:	O-RING		
			<b>M-S70760</b>	<b>M-E70760</b>	<b>A-R60300 G-0850190000 K-800001011000 M-03475N0</b>			
NM-Germany Article no. Artikelnummer/ Modelo Número / статья НОМЕР	NM-Germany Article no.	NM-Germany Article no.	NM-Germany Article no.	NM-Germany Article no.	NM-Germany Article no.	NM-Germany Article no.	NM-Germany Article no.	
			<b>KBSVW40874G</b>	<b>KBVW40874G</b>	<b>KRVW40874G</b>			

## GASOLINE

ENGINE TYPE Motortyp Type de Moteur Tipo de motor Тип двигателя	LINER KIT Liner Kit Kit de Chemise Camisas de los cilindros лайнер комплект	CYL. LINER Zylinderlaufbuchse Chemise Camisas de los cilindros втулка цилиндра	PISTON + RINGS Kolben + Ringe Piston + Segments Pistón Set Поршень и кольца			PISTON SET Kolben Set Set de Piston Pistón Set поршневой	RINGS SET Kolben Set Segments de Piston Anillos Set кольца	PIN Pin Axe Perno Пин	
<b>AP 800</b> 4 Cyl 81.0 mm Bore Ø 1,781 cc		Length: Outside Ø: Flange Ø: flange depth	Length: Comp: Height:	61.2	32.25	Top: 1.5 2nd: 1.75 3rd: 3.0 1st oil: 2nd oil:	Ø: 20.0 Length: 57.0		
								1.05	
								-8.1	
		Reference no.:	Reference no.:	Reference no.:	Reference no.:	O-RING			
			<b>M-S70780</b>	<b>M-E70780</b>	<b>A-R60300 G-0850190000 K-800001011000 M-03475N0</b>				
NM-Germany Article no. Artikelnummer/ Modelo Número / статья НОМЕР	NM-Germany Article no.	NM-Germany Article no.	NM-Germany Article no.	NM-Germany Article no.	NM-Germany Article no.	NM-Germany Article no.	NM-Germany Article no.		
			<b>KBSVW40875G</b>	<b>KBVW40875G</b>	<b>KRVW40875G</b>				

**GASOLINE**

ENGINE TYPE Motortyp Type de Moteur Tipo de motor Тип двигателя	LINER KIT Liner Kit Kit de Chemise Camisas de los cilindros лайнер комплект	CYL. LINER Zylinderlaufbuchse Chemise Camisas de los cilindros втулка цилиндра	PISTON + RINGS Kolben + Ringe Piston + Segments Pistón Set Поршень и кольца			PISTON SET Kolben Set Set de Piston Pistón Set поршневой	RINGS SET Kolben Set Segments de Piston Anillos Set кольца	PIN Pin Axe Perno Пин				
<b>AP 504/505/521</b> <b>AP 540/541/542</b> 4 Cyl 81.0 mm Bore Ø 1,595 cc		Length: Outside Ø: Flange Ø: flange depth	Length: 61.8 Comp: 37.0 Height: 1.1 -1.7			Top: 1.2 2nd: 1.5 3rd: 2.0 1st oil: 2nd oil:	Ø: 20.0 Length: 67.0					
								Reference no.:	Reference no.:	Reference no.:	Reference no.:	O-RING
									<b>M-S70890</b>	<b>M-E70890</b>	<b>G-0810590000</b> <b>K-800039440000</b> <b>M-03301N0</b>	
NM-Germany Article no. Artikelnummer/ Modelo Número / статья НОМЕР	NM-Germany Article no.	NM-Germany Article no.	NM-Germany Article no.	NM-Germany Article no.	NM-Germany Article no.	NM-Germany Article no.	NM-Germany Article no.					
			<b>KBSVW40876G</b>	<b>KBVW40876G</b>	<b>KRVW40876G</b>							

**GASOLINE**

ENGINE TYPE Motortyp Type de Moteur Tipo de motor Тип двигателя	LINER KIT Liner Kit Kit de Chemise Camisas de los cilindros лайнер комплект	CYL. LINER Zylinderlaufbuchse Chemise Camisas de los cilindros втулка цилиндра	PISTON + RINGS Kolben + Ringe Piston + Segments Pistón Set Поршень и кольца			PISTON SET Kolben Set Set de Piston Pistón Set поршневой	RINGS SET Kolben Set Segments de Piston Anillos Set кольца	PIN Pin Axe Perno Пин				
<b>AP 522</b> <b>AP 543</b> 4 Cyl 81.0 mm Bore Ø 1,781 cc		Length: Outside Ø: Flange Ø: flange depth	Length: 57.5 Comp: 32.2 Height: 1.2 -2.8			Top: 1.2 2nd: 1.5 3rd: 2.0 1st oil: 2nd oil:	Ø: 20.0 Length: 57.0					
								Reference no.:	Reference no.:	Reference no.:	Reference no.:	O-RING
									<b>M-S70990</b>	<b>M-E70990</b>	<b>G-0810590000</b> <b>K-800039440000</b> <b>M-03301N0</b>	
NM-Germany Article no. Artikelnummer/ Modelo Número / статья НОМЕР	NM-Germany Article no.	NM-Germany Article no.	NM-Germany Article no.	NM-Germany Article no.	NM-Germany Article no.	NM-Germany Article no.	NM-Germany Article no.					
			<b>KBSVW40877G</b>	<b>KBVW40877G</b>	<b>KRVW40877G</b>							

**GASOLINE**

ENGINE TYPE Motortyp Type de Moteur Tipo de motor Тип двигателя	LINER KIT Liner Kit Kit de Chemise Camisas de los cilindros лайнер комплект	CYL. LINER Zylinderlaufbuchse Chemise Camisas de los cilindros втулка цилиндра	PISTON + RINGS Kolben + Ringe Piston + Segments Pistón Set Поршень и кольца			PISTON SET Kolben Set Set de Piston Pistón Set поршневой	RINGS SET Kolben Set Segments de Piston Anillos Set кольца	PIN Pin Axe Perno Пин				
<b>AP 600</b> 4 Cyl 81.0 mm Bore Ø 1,595 cc		Length: Outside Ø: Flange Ø: flange depth	Length: 66.8 Comp: 35.6 Height: 2.2 -2.7			Top: 1.5 2nd: 1.75 3rd: 3.0 1st oil: 2nd oil:	Ø: 20.0 Length: 57.0					
								Reference no.:	Reference no.:	Reference no.:	Reference no.:	O-RING
									<b>M-S70680</b>	<b>M-E70680</b>	<b>A-R60300</b> <b>G-0850190000</b> <b>K-800001011000</b> <b>M-03475N0</b>	
NM-Germany Article no. Artikelnummer/ Modelo Número / статья НОМЕР	NM-Germany Article no.	NM-Germany Article no.	NM-Germany Article no.	NM-Germany Article no.	NM-Germany Article no.	NM-Germany Article no.	NM-Germany Article no.					
			<b>KBSVW40878G</b>	<b>KBVW40878G</b>	<b>KRVW40878G</b>							

**GASOLINE**

ENGINE TYPE Motortyp Type de Moteur Tipo de motor Тип двигателя	LINER KIT Liner Kit Kit de Chemise Camisas de los cilindros лайнер комплект	CYL. LINER Zylinderlaufbuchse Chemise Camisas de los cilindros втулка цилиндра	PISTON + RINGS Kolben + Ringe Piston + Segments Pistón Set Поршень и кольца		PISTON SET Kolben Set Set de Piston Pistón Set поршневой	RINGS SET Kolben Set Segments de Piston Anillos Set кольца	PIN Pin Axe Perno Пин	
<b>AP 600</b> 4 Cyl 81.0 mm Bore Ø 1,595 cc		Length: Outside Ø: Flange Ø: flange depth	Length:	67.0		Top:	1.5	Ø: 20.0 Length: 57.0
			Comp:	38.0		2nd:	1.75	
			Height:	0		3rd:	3.0	
			Reference no.:	Reference no.:	Reference no.:	Reference no.:	O-RING	
				<b>M-S70650</b>	<b>M-E70650</b>	<b>A-R60300</b> <b>G-0850190000</b> <b>K-800001011000</b> <b>M-03475N0</b>		
NM-Germany Article no. Artikelnummer/ Modelo Número / статья НОМЕР	NM-Germany Article no.	NM-Germany Article no.	NM-Germany Article no.	NM-Germany Article no.	NM-Germany Article no.	NM-Germany Article no.	NM-Germany Article no.	
			<b>KBSVW40879G</b>	<b>KBVW40879G</b>	<b>KRVW40879G</b>			

VW



**GASOLINE**

ENGINE TYPE Motortyp Type de Moteur Tipo de motor Тип двигателя	LINER KIT Liner Kit Kit de Chemise Camisas de los cilindros лайнер комплект	CYL. LINER Zylinderlaufbuchse Chemise Camisas de los cilindros втулка цилиндра	PISTON + RINGS Kolben + Ringe Piston + Segments Pistón Set Поршень и кольца		PISTON SET Kolben Set Set de Piston Pistón Set поршневой	RINGS SET Kolben Set Segments de Piston Anillos Set кольца	PIN Pin Axe Perno Пин
<b>AP UDC</b> 4 Cyl 81.0 mm Bore Ø 1,781 cc		Length: Outside Ø: Flange Ø: flange depth		STD	O/S	Top: 1.2 2nd: 1.5 3rd: 2.0 1st oil: 2.0 2nd oil:	Ø: 20.0 Length: 57.0
			Length:	56.2	55.9		
			Comp:	32.2	31.9		
			Flange Ø:	1.1	1.1		
			flange depth	-4.8	-4.8		
			Reference no.:	Reference no.:	Reference no.:	Reference no.:	O-RING
				<b>K-97328600</b> <b>M-S70830</b>	<b>M-E70830</b>	<b>G-0810590000</b> <b>K-800039440000</b> <b>M-03301N0</b>	
NM-Germany Article no. Artikelnummer/ Modelo Número / статья НОМЕР	NM-Germany Article no.	NM-Germany Article no.	NM-Germany Article no.	NM-Germany Article no.	NM-Germany Article no.	NM-Germany Article no.	NM-Germany Article no.
			<b>KBSVW40880G</b>	<b>KBVW40880G</b>	<b>KRVW40880G</b>		

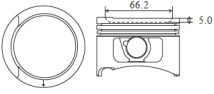

**GASOLINE**

ENGINE TYPE Motortyp Type de Moteur Tipo de motor Тип двигателя	LINER KIT Liner Kit Kit de Chemise Camisas de los cilindros лайнер комплект	CYL. LINER Zylinderlaufbuchse Chemise Camisas de los cilindros втулка цилиндра	PISTON + RINGS Kolben + Ringe Piston + Segments Pistón Set Поршень и кольца		PISTON SET Kolben Set Set de Piston Pistón Set поршневой	RINGS SET Kolben Set Segments de Piston Anillos Set кольца	PIN Pin Axe Perno Пин
<b>ALZ/ANA/AVU</b> <b>AYD/BFQ/BFS</b> <b>BGU/BSE/BSF</b> 4 Cyl 81.0 mm Bore Ø 1,595 cc		Length: Outside Ø: Flange Ø: flange depth		STD	O/S	Top: 1.0 2nd: 1.2 3rd: 2.0 1st oil: 2.0 2nd oil:	Ø: 19.0 Length: 42.0
			Length:	50.8	50.45		
			Comp:	29.7	29.45		
			Height:	-2.7	-2.7		
			Reference no.:	Reference no.:	Reference no.:	Reference no.:	O-RING
				<b>K-99792600</b> <b>M-0332000</b>		<b>G-0814830000</b> <b>K-800049841050</b> <b>M-03077N0</b>	
NM-Germany Article no. Artikelnummer/ Modelo Número / статья НОМЕР	NM-Germany Article no.	NM-Germany Article no.	NM-Germany Article no.	NM-Germany Article no.	NM-Germany Article no.	NM-Germany Article no.	NM-Germany Article no.
			<b>KBSVW40881G</b>	<b>KBVW40881G</b>	<b>KRVW40881G</b>		

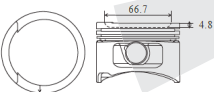

**GASOLINE**

ENGINE TYPE Motortyp Type de Moteur Tipo de motor Тип двигателя	LINER KIT Liner Kit Kit de Chemise Camisas de los cilindros лайнер комплект	CYL. LINER Zylinderlaufbuchse Chemise Camisas de los cilindros втулка цилиндра	PISTON + RINGS Kolben + Ringe Piston + Segments Pistón Set Поршень и кольца		PISTON SET Kolben Set Set de Piston Pistón Set поршневой	RINGS SET Kolben Set Segments de Piston Anillos Set кольца	PIN Pin Axe Perno Пин	
<b>AAV ADV</b> 5 Cyl 82.5 mm Bore Ø 2,480 cc 2,553 cc  		Length:		Length:	58.7	head, top and 2nd ring lands anodized  Top: 1.5 2nd: 1.5 3rd: 1.5 1st oil: 2.0 2nd oil: 2.0	Ø: 20.0 Length: 57.0	
		Outside Ø:		Comp:	29.0			
		Flange Ø:		Height:	0.7			
		flange depth			-5.0			
		Reference no.:		Reference no.:		Reference no.:		O-RING
NM-Germany Article no. Artikelnummer/ Modelo Número / статья НОМЕР	NM-Germany Article no.	NM-Germany Article no.	NM-Germany Article no.	NM-Germany Article no.	NM-Germany Article no.	NM-Germany Article no.	NM-Germany Article no.	
			KBSVW50882G	KBVW50882G	KRVW50882G			

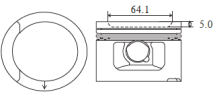

**GASOLINE**

ENGINE TYPE Motortyp Type de Moteur Tipo de motor Тип двигателя	LINER KIT Liner Kit Kit de Chemise Camisas de los cilindros лайнер комплект	CYL. LINER Zylinderlaufbuchse Chemise Camisas de los cilindros втулка цилиндра	PISTON + RINGS Kolben + Ringe Piston + Segments Pistón Set Поршень и кольца		PISTON SET Kolben Set Set de Piston Pistón Set поршневой	RINGS SET Kolben Set Segments de Piston Anillos Set кольца	PIN Pin Axe Perno Пин	
<b>AAV ADV</b> 5 Cyl 82.5 mm Bore Ø 2,480 cc 2,553 cc  		Length:		Length:	59.2	Top: 1.5 2nd: 1.5 3rd: 1.5 1st oil: 2.0 2nd oil: 2.0	Ø: 20.0 Length: 57.0	
		Outside Ø:		Comp:	29.5			
		Flange Ø:		Height:	0.7			
		flange depth			-4.8			
		Reference no.:		Reference no.:		Reference no.:		O-RING
NM-Germany Article no. Artikelnummer/ Modelo Número / статья НОМЕР	NM-Germany Article no.	NM-Germany Article no.	NM-Germany Article no.	NM-Germany Article no.	NM-Germany Article no.	NM-Germany Article no.	NM-Germany Article no.	
			KBSVW50883G	KBVW50883G	KRVW50883G			

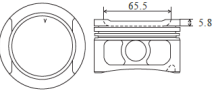

**GASOLINE**

ENGINE TYPE Motortyp Type de Moteur Tipo de motor Тип двигателя	LINER KIT Liner Kit Kit de Chemise Camisas de los cilindros лайнер комплект	CYL. LINER Zylinderlaufbuchse Chemise Camisas de los cilindros втулка цилиндра	PISTON + RINGS Kolben + Ringe Piston + Segments Pistón Set Поршень и кольца		PISTON SET Kolben Set Set de Piston Pistón Set поршневой	RINGS SET Kolben Set Segments de Piston Anillos Set кольца	PIN Pin Axe Perno Пин	
<b>2E/ADY AGG/AKR</b> 4 Cyl 82.5 mm Bore Ø 1,984 cc  				STD	O/S	Top: 1.2 2nd: 1.5 3rd: 1.5 1st oil: 2.0 2nd oil: 2.0	Ø: 21.0 Length: 59.0	
		Length:		Length:	63.8			63.5
		Outside Ø:		Comp:	30.9			30.6
		Flange Ø:		Height:	+0.9	+0.9		
		flange depth			-5.0	-5.0		
		Reference no.:		Reference no.:		Reference no.:		O-RING
NM-Germany Article no. Artikelnummer/ Modelo Número / статья НОМЕР	NM-Germany Article no.	NM-Germany Article no.	NM-Germany Article no.	NM-Germany Article no.	NM-Germany Article no.	NM-Germany Article no.	NM-Germany Article no.	
			KBSVW40884G	KBVW40884G	KRVW40884G			

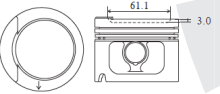

**GASOLINE**

ENGINE TYPE Motortyp Type de Moteur Tipo de motor Тип двигателя	LINER KIT Liner Kit Kit de Chemise Camisas de los cilindros лайнер комплект	CYL. LINER Zylinderlaufbuchse Chemise Camisas de los cilindros втулка цилиндра	PISTON + RINGS Kolben + Ringe Piston + Segments Pistón Set Поршень и кольца		PISTON SET Kolben Set Set de Piston Pistón Set поршневой	RINGS SET Kolben Set Segments de Piston Anillos Set кольца	PIN Pin Axe Perno Пин
<b>AEG/APK/AQY AXA/BBX/BER BHP/CBPA</b> 4 Cyl 82.5 mm Bore Ø 1,984 cc 		Length: Outside Ø: Flange Ø: flange depth	Length:	STD	O/S	Top: 1.2	Ø: 20.0 Length: 52.0
			50.8	50.5	2nd: 1.5		
			Comp: 29.3	29.0	3rd: 2.0		
		Height: +0.7	+0.7	1st oil: 2.0	2nd oil:		
		flange depth	-5.8	-5.8			
		Reference no.:	Reference no.:	Reference no.:	Reference no.:	O-RING	
			K-99870600 M-0306000		A-R60310 G-0850180000 K-800001220000 K-800045720000 M-03031N0 M-03060N0 M-03075N0 M-03319N0 T-50018 T-50025		
NM-Germany Article no. Artikelnummer/ Modelo Número / статья НОМЕР	NM-Germany Article no.	NM-Germany Article no.	NM-Germany Article no.	NM-Germany Article no.	NM-Germany Article no.	NM-Germany Article no.	
			KBSVW40885G	KBVW40885G	KRVW40885G		



**GASOLINE**

ENGINE TYPE Motortyp Type de Moteur Tipo de motor Тип двигателя	LINER KIT Liner Kit Kit de Chemise Camisas de los cilindros лайнер комплект	CYL. LINER Zylinderlaufbuchse Chemise Camisas de los cilindros втулка цилиндра	PISTON + RINGS Kolben + Ringe Piston + Segments Pistón Set Поршень и кольца		PISTON SET Kolben Set Set de Piston Pistón Set поршневой	RINGS SET Kolben Set Segments de Piston Anillos Set кольца	PIN Pin Axe Perno Пин
<b>AFU</b> 5 Cyl 82.5 mm Bore Ø 2,309 cc 		Length: Outside Ø: Flange Ø: flange depth	Length:	64.2		Top: 1.5	Ø: 20.0 Length: 56.7
			32.7		2nd: 1.5		
			Comp: 2.5		3rd: 2.0		
		Height: -3.0		1st oil: 2.0	2nd oil:		
		flange depth					
		Reference no.:	Reference no.:	Reference no.:	Reference no.:	O-RING	
NM-Germany Article no. Artikelnummer/ Modelo Número / статья НОМЕР	NM-Germany Article no.	NM-Germany Article no.	NM-Germany Article no.	NM-Germany Article no.	NM-Germany Article no.	NM-Germany Article no.	
			KBSVW50886G	KBVW50886G	KRVW50886G		

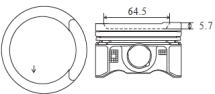

**GASOLINE**

ENGINE TYPE Motortyp Type de Moteur Tipo de motor Тип двигателя	LINER KIT Liner Kit Kit de Chemise Camisas de los cilindros лайнер комплект	CYL. LINER Zylinderlaufbuchse Chemise Camisas de los cilindros втулка цилиндра	PISTON + RINGS Kolben + Ringe Piston + Segments Pistón Set Поршень и кольца		PISTON SET Kolben Set Set de Piston Pistón Set поршневой	RINGS SET Kolben Set Segments de Piston Anillos Set кольца	PIN Pin Axe Perno Пин
<b>6A 9A</b> 4 Cyl 82.5 mm Bore Ø 1,984 cc 		Length: Outside Ø: Flange Ø: flange depth	Length:	STD	O/S	Top: 1.2	Ø: 20.0 Length: 57.0
			54.8	54.5	2nd: 1.5		
			Comp: 29.8	29.5	3rd: 2.0		
		Height: -3.1	-3.1	1st oil: 2.0	2nd oil:		
		flange depth	-3.6	-3.6	skirt MOS2 treated		
		Reference no.:	Reference no.:	Reference no.:	Reference no.:	O-RING	
			K-91504700		A-R60310 G-0850180000 K-800001220000 K-800045720000 M-03031N0 M-03060N0 M-03075N0 M-03319N0 T-50018 T-50025		
NM-Germany Article no. Artikelnummer/ Modelo Número / статья НОМЕР	NM-Germany Article no.	NM-Germany Article no.	NM-Germany Article no.	NM-Germany Article no.	NM-Germany Article no.	NM-Germany Article no.	
			KBSVW40887G	KBVW40887G	KRVW40887G		

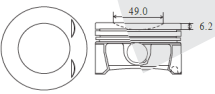

**GASOLINE**

ENGINE TYPE Motortyp Type de Moteur Tipo de motor Тип двигателя	LINER KIT Liner Kit Kit de Chemise Camisas de los cilindros лайнер комплект	CYL. LINER Zylinderlaufbuchse Chemise Camisas de los cilindros втулка цилиндра	PISTON + RINGS Kolben + Ringe Piston + Segments Pistón Set Поршень и кольца		PISTON SET Kolben Set Set de Piston Pistón Set поршневой	RINGS SET Kolben Set Segments de Piston Anillos Set кольца	PIN Pin Axe Perno Пин
<b>2E</b> 4 Cyl 82.5 mm Bore Ø 1,984 cc		Length: Outside Ø: Flange Ø: flange depth	STD	O/S	skirt MOS2 treated	Top: 1.2	Ø: 21.0 Length: 56.0
			Length: 51.8	51.5		2nd: 1.5	
			Comp: 30.9	30.6		3rd: 2.0	
			Height: +0.9	+0.9		1st oil: 2.0	
			-5.7	-5.7		2nd oil:	
		<b>Reference no.:</b>	<b>Reference no.:</b>	<b>Reference no.:</b>	<b>Reference no.:</b>	<b>O-RING</b>	
			<b>M-0303100</b> <b>N-8750180020</b>		<b>A-R60310</b> <b>G-0850180000</b> <b>K-800001220000</b> <b>K-800045720000</b> <b>M-03031N0</b> <b>M-03060N0</b> <b>M-03075N0</b> <b>M-03319N0</b> <b>T-50018</b> <b>T-50025</b>		
NM-Germany Article no. Artikelnummer/ Modelo Número / статья НОМЕР	NM-Germany Article no.	NM-Germany Article no.	NM-Germany Article no.	NM-Germany Article no.	NM-Germany Article no.	NM-Germany Article no.	NM-Germany Article no.
			<b>KBSVW40888G</b>	<b>KBVW40888G</b>	<b>KRVW40888G</b>		

**GASOLINE**

ENGINE TYPE Motortyp Type de Moteur Tipo de motor Тип двигателя	LINER KIT Liner Kit Kit de Chemise Camisas de los cilindros лайнер комплект	CYL. LINER Zylinderlaufbuchse Chemise Camisas de los cilindros втулка цилиндра	PISTON + RINGS Kolben + Ringe Piston + Segments Pistón Set Поршень и кольца		PISTON SET Kolben Set Set de Piston Pistón Set поршневой	RINGS SET Kolben Set Segments de Piston Anillos Set кольца	PIN Pin Axe Perno Пин
<b>BPY</b> <b>CBFA</b> <b>CCTA</b> 4 Cyl 82.5 mm Bore Ø 1,998 cc		Length: Outside Ø: Flange Ø: flange depth	Length: 50.6		alfin skirt MOS2 treated fits tapered con. rod	Top: 1.2	Ø: 20.0 Length: 59.0
			Comp: 29.6			2nd: 1.5	
			Height: -6.2			3rd: 2.0	
						1st oil: 2.0	
						2nd oil:	
		<b>Reference no.:</b>	<b>Reference no.:</b>	<b>Reference no.:</b>	<b>Reference no.:</b>	<b>O-RING</b>	
			<b>06D 107 066 C</b> <b>06D 107 104 C</b> <b>M-0332100</b>		<b>A-R60310</b> <b>G-0850180000</b> <b>K-800001220000</b> <b>K-800045720000</b> <b>M-03031N0</b> <b>M-03060N0</b> <b>M-03075N0</b> <b>M-03319N0</b> <b>T-50018</b> <b>T-50025</b>		
NM-Germany Article no. Artikelnummer/ Modelo Número / статья НОМЕР	NM-Germany Article no.	NM-Germany Article no.	NM-Germany Article no.	NM-Germany Article no.	NM-Germany Article no.	NM-Germany Article no.	NM-Germany Article no.
			<b>KBSVW40889GA</b>	<b>KBVW40889GA</b>	<b>KRVW40889GA</b>		

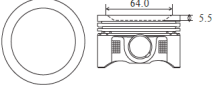
**GASOLINE**

ENGINE TYPE Motortyp Type de Moteur Tipo de motor Тип двигателя	LINER KIT Liner Kit Kit de Chemise Camisas de los cilindros лайнер комплект	CYL. LINER Zylinderlaufbuchse Chemise Camisas de los cilindros втулка цилиндра	PISTON + RINGS Kolben + Ringe Piston + Segments Pistón Set Поршень и кольца		PISTON SET Kolben Set Set de Piston Pistón Set поршневой	RINGS SET Kolben Set Segments de Piston Anillos Set кольца	PIN Pin Axe Perno Пин
<b>2.0L SOHC 8V</b> 4 Cyl 82.5 mm Bore Ø 1,984 cc		Length: Outside Ø: Flange Ø: flange depth	Length: 50.6			Top: 1.2	Ø: 21.0 Length: 56.0
			Comp: 30.6			2nd: 1.5	
			Height: -5.5			3rd: 2.0	
						1st oil: 2.0	
						2nd oil:	
		<b>Reference no.:</b>	<b>Reference no.:</b>	<b>Reference no.:</b>	<b>Reference no.:</b>	<b>O-RING</b>	
				<b>481 107 065 5</b>	<b>A-R60310</b> <b>G-0850180000</b> <b>K-800001220000</b> <b>K-800045720000</b> <b>M-03031N0</b> <b>M-03060N0</b> <b>M-03075N0</b> <b>M-03319N0</b> <b>T-50018</b> <b>T-50025</b>		
NM-Germany Article no. Artikelnummer/ Modelo Número / статья НОМЕР	NM-Germany Article no.	NM-Germany Article no.	NM-Germany Article no.	NM-Germany Article no.	NM-Germany Article no.	NM-Germany Article no.	NM-Germany Article no.
			<b>KBSVW40890G</b>	<b>KBVW40890G</b>	<b>KRVW40890G</b>		

**GASOLINE**

ENGINE TYPE Motortyp Type de Moteur Tipo de motor Тип двигателя	LINER KIT Liner Kit Kit de Chemise Camisas de los cilindros лайнер комплект	CYL. LINER Zylinderlaufbuchse Chemise Camisas de los cilindros втулка цилиндра	PISTON + RINGS Kolben + Ringe Piston + Segments Pistón Set Поршень и кольца		PISTON SET Kolben Set Set de Piston Pistón Set поршневой	RINGS SET Kolben Set Segments de Piston Anillos Set кольца	PIN Pin Axe Perno Пин
<b>AP 528/529</b> <b>AP 546/547</b> 4 Cyl 82.5 mm Bore Ø 1,984 cc		Length: Outside Ø: Flange Ø: flange depth	Length:	58.2		Top: 1.5 2nd: 1.5 3rd: 1.5 1st oil: 2.0 2nd oil:	Ø: 20.0 Length: 57.0
			Comp:	29.2			
			Height:	-5.0			
		Reference no.:	Reference no.:	Reference no.:	Reference no.:	O-RING	
			<b>M-S70870</b>	<b>M-E70870</b>	<b>G-0850060000</b> <b>M-A70860</b>		
NM-Germany Article no. Artikelnummer/ Modelo Número / статья НОМЕР	NM-Germany Article no.	NM-Germany Article no.	NM-Germany Article no.	NM-Germany Article no.	NM-Germany Article no.	NM-Germany Article no.	
			<b>KBSVW40891G</b>	<b>KBVW40891G</b>	<b>KRVW40891G</b>		

VW



**GASOLINE**

ENGINE TYPE Motortyp Type de Moteur Tipo de motor Тип двигателя	LINER KIT Liner Kit Kit de Chemise Camisas de los cilindros лайнер комплект	CYL. LINER Zylinderlaufbuchse Chemise Camisas de los cilindros втулка цилиндра	PISTON + RINGS Kolben + Ringe Piston + Segments Pistón Set Поршень и кольца		PISTON SET Kolben Set Set de Piston Pistón Set поршневой	RINGS SET Kolben Set Segments de Piston Anillos Set кольца	PIN Pin Axe Perno Пин
<b>2.0L AP</b> 4 Cyl 82.5 mm Bore Ø 1,978 cc		Length: Outside Ø: Flange Ø: flange depth	Length:	56.5		Top: 1.5 2nd: 1.5 3rd: 1.5 1st oil: 2.0 2nd oil:	Ø: 20.0 Length: 57.0
			Comp:	29.3			
			Height:	-5.4			
		Reference no.:	Reference no.:	Reference no.:	Reference no.:	O-RING	
			<b>M-S70880</b>	<b>M-E70880</b>	<b>G-0850060000</b> <b>M-A70860</b>		
NM-Germany Article no. Artikelnummer/ Modelo Número / статья НОМЕР	NM-Germany Article no.	NM-Germany Article no.	NM-Germany Article no.	NM-Germany Article no.	NM-Germany Article no.	NM-Germany Article no.	
			<b>KBSVW40892G</b>	<b>KBVW40892G</b>	<b>KRVW40892G</b>		

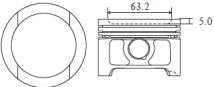

**GASOLINE**

ENGINE TYPE Motortyp Type de Moteur Tipo de motor Тип двигателя	LINER KIT Liner Kit Kit de Chemise Camisas de los cilindros лайнер комплект	CYL. LINER Zylinderlaufbuchse Chemise Camisas de los cilindros втулка цилиндра	PISTON + RINGS Kolben + Ringe Piston + Segments Pistón Set Поршень и кольца		PISTON SET Kolben Set Set de Piston Pistón Set поршневой	RINGS SET Kolben Set Segments de Piston Anillos Set кольца	PIN Pin Axe Perno Пин	
<b>2.0L AP ALC</b> 4 Cyl 82.5 mm Bore Ø 1,978 cc		Length: Outside Ø: Flange Ø: flange depth	Length:	57.4	57.1		Top: 1.5 2nd: 1.5 3rd: 1.5 1st oil: 2.0 2nd oil:	Ø: 20.0 Length: 57.0
			Comp:	29.3	29.0			
			Height:	+1.1	+1.1			
		Reference no.:	Reference no.:	Reference no.:	Reference no.:	O-RING		
			<b>M-S70860</b>	<b>M-E70860</b>	<b>G-0850060000</b> <b>M-A70860</b>			
NM-Germany Article no. Artikelnummer/ Modelo Número / статья НОМЕР	NM-Germany Article no.	NM-Germany Article no.	NM-Germany Article no.	NM-Germany Article no.	NM-Germany Article no.	NM-Germany Article no.		
			<b>KBSVW40893G</b>	<b>KBVW40893G</b>	<b>KRVW40893G</b>			

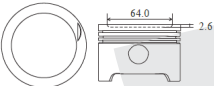

**GASOLINE**

ENGINE TYPE Motortyp Type de Moteur Tipo de motor Тип двигателя	LINER KIT Liner Kit Kit de Chemise Camisas de los cilindros лайнер комплект	CYL. LINER Zylinderlaufbuchse Chemise Camisas de los cilindros втулка цилиндра	PISTON + RINGS Kolben + Ringe Piston + Segments Pistón Set Поршень и кольца			PISTON SET Kolben Set Set de Piston Pistón Set поршневой	RINGS SET Kolben Set Segments de Piston Anillos Set кольца	PIN Pin Axe Perno Пин
<b>ATM/AZH/AZJ</b> <b>AZM/BEH/BEJ</b> 4 Cyl 82.5 mm Bore Ø 1,984 cc 		Length:		Length:	51.0	Top:	1.2	Ø: 19.0 Length: 42.0
		Outside Ø:		Comp:	29.3	2nd:	1.5	
		Flange Ø:		Height:	-5.0	3rd:		
		flange depth				2nd oil:		
			<b>Reference no.:</b>	<b>Reference no.:</b>	<b>Reference no.:</b>	<b>Reference no.:</b>	<b>O-RING</b>	
				<b>M-0309200</b>	<b>06B 107 065 B</b> <b>06B 107 065 Q</b> <b>06B 107 103 B</b>	<b>A-R60310</b> <b>G-0850180000</b> <b>K-800001220000</b> <b>K-800045720000</b> <b>M-03031N0</b> <b>M-03060N0</b> <b>M-03075N0</b> <b>M-03319N0</b> <b>T-50018</b> <b>T-50025</b>		
NM-Germany Article no. Artikelnummer/ Modelo Número / статья НОМЕР	NM-Germany Article no.	NM-Germany Article no.	NM-Germany Article no.	NM-Germany Article no.	NM-Germany Article no.	NM-Germany Article no.	NM-Germany Article no.	NM-Germany Article no.
			<b>KBSVW40894G</b>	<b>KBVW40894G</b>	<b>KRVW40894G</b>			

**GASOLINE**

ENGINE TYPE Motortyp Type de Moteur Tipo de motor Тип двигателя	LINER KIT Liner Kit Kit de Chemise Camisas de los cilindros лайнер комплект	CYL. LINER Zylinderlaufbuchse Chemise Camisas de los cilindros втулка цилиндра	PISTON + RINGS Kolben + Ringe Piston + Segments Pistón Set Поршень и кольца			PISTON SET Kolben Set Set de Piston Pistón Set поршневой	RINGS SET Kolben Set Segments de Piston Anillos Set кольца	PIN Pin Axe Perno Пин
<b>ALT</b> 4 Cyl 82.51 mm Bore Ø 1,984 cc 		Length:		Length:	50.6	Top:	1.2	Ø: 19.0 Length: 44.0
		Outside Ø:		Comp:	29.6	2nd:	1.5	
		Flange Ø:		Height:	-2.6	3rd:		
		flange depth				2nd oil:		
			<b>Reference no.:</b>	<b>Reference no.:</b>	<b>Reference no.:</b>	<b>Reference no.:</b>	<b>O-RING</b>	
				<b>M-0308300</b>	<b>06B 107 065 AA</b> <b>06B 107 065 AG</b> <b>06B 107 065 L</b>	<b>06C 198 151 B</b> <b>06D 107 301 A</b> <b>06D 198 151 A/B</b> <b>06F 198 151 A</b> <b>078 107 321 A</b> <b>A-R60310</b> <b>G-0850180000</b> <b>K-800001220000</b> <b>K-800045720000</b> <b>M-03031N0</b> <b>M-03060N0</b> <b>M-03075N0</b> <b>M-03319N0</b> <b>T-50018/25</b>		
NM-Germany Article no. Artikelnummer/ Modelo Número / статья НОМЕР	NM-Germany Article no.	NM-Germany Article no.	NM-Germany Article no.	NM-Germany Article no.	NM-Germany Article no.	NM-Germany Article no.	NM-Germany Article no.	NM-Germany Article no.
			<b>KBSVW40895G</b>	<b>KBVW40895G</b>	<b>KRVW40895G</b>			

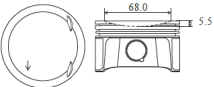
**DIESEL**

ENGINE TYPE Motortyp Type de Moteur Tipo de motor Тип двигателя	LINER KIT Liner Kit Kit de Chemise Camisas de los cilindros лайнер комплект	CYL. LINER Zylinderlaufbuchse Chemise Camisas de los cilindros втулка цилиндра	PISTON + RINGS Kolben + Ringe Piston + Segments Pistón Set Поршень и кольца			PISTON SET Kolben Set Set de Piston Pistón Set поршневой	RINGS SET Kolben Set Segments de Piston Anillos Set кольца	PIN Pin Axe Perno Пин	
<b>BGP/BGQ</b> <b>BTK/CCC</b> 5 Cyl 82.5 mm Bore Ø 2,480 cc 	<b>07K 107 065 B</b>	Length:		Length:	50.3	head, top and 2nd ring lands anodized skirt MOS2 treated	Top:	1.2	Ø: 19.0 Length: 44.0
		Outside Ø:		Comp:	29.3		2nd:	1.5	
		Flange Ø:		Height:	-5.5		3rd:		
		flange depth				2nd oil:			
			<b>Reference no.:</b>	<b>Reference no.:</b>	<b>Reference no.:</b>	<b>Reference no.:</b>	<b>O-RING</b>		
				<b>07K 107 065 B</b>	<b>M-82L113</b>	<b>06D 198 151 A</b> <b>06D 198 151 B</b> <b>M-03319N0</b>			
NM-Germany Article no. Artikelnummer/ Modelo Número / статья НОМЕР	NM-Germany Article no.	NM-Germany Article no.	NM-Germany Article no.	NM-Germany Article no.	NM-Germany Article no.	NM-Germany Article no.	NM-Germany Article no.	NM-Germany Article no.	
			<b>KBSVW50896D</b>	<b>KBVW50896D</b>	<b>KRVW50896D</b>				



## GASOLINE

ENGINE TYPE Motortyp Type de Moteur Tipo de motor Тип двигателя	LINER KIT Liner Kit Kit de Chemise Camisas de los cilindros лайнер комплект	CYL. LINER Zylinderlaufbuchse Chemise Camisas de los cilindros втулка цилиндра	PISTON + RINGS Kolben + Ringe Piston + Segments Pistón Set Поршень и кольца		PISTON SET Kolben Set Set de Piston Pistón Set поршневой	RINGS SET Kolben Set Segments de Piston Anillos Set кольца	PIN Pin Axe Perno Пин	
<b>3.0L V6</b> <b>6 Cyl</b> <b>82.5 mm Bore Ø</b> <b>2,976 cc</b>		Length: 70.0 Outside Ø: Flange Ø: flange depth	Length:	48.6	skirt MOS2 treated fits tapered con. rod	Top:	1.2	Ø: 20.0 Length: 44.0
			Comp:	27.6		2nd:	1.5	
			Height:	-1.0		3rd:	2.0	
			Reference no.:	Reference no.:	Reference no.:	Reference no.:	O-RING	
				<b>M-0339900</b>		<b>A-R60310</b> <b>G-0850180000</b> <b>K-800001220000</b> <b>K-800045720000</b> <b>M-03031N0</b> <b>M-03060N0</b> <b>M-03075N0</b> <b>M-03319N0</b> <b>T-50018</b> <b>T-50025</b>		
NM-Germany Article no. Artikelnummer/ Modelo Número / статья НОМЕР	NM-Germany Article no.	NM-Germany Article no.	NM-Germany Article no.	NM-Germany Article no.	NM-Germany Article no.	NM-Germany Article no.	NM-Germany Article no.	
			<b>KBSVW60897G</b>	<b>KBVW60897G</b>	<b>KRVW60897G</b>			

VW



## GASOLINE

ENGINE TYPE Motortyp Type de Moteur Tipo de motor Тип двигателя	LINER KIT Liner Kit Kit de Chemise Camisas de los cilindros лайнер комплект	CYL. LINER Zylinderlaufbuchse Chemise Camisas de los cilindros втулка цилиндра	PISTON + RINGS Kolben + Ringe Piston + Segments Pistón Set Поршень и кольца		PISTON SET Kolben Set Set de Piston Pistón Set поршневой	RINGS SET Kolben Set Segments de Piston Anillos Set кольца	PIN Pin Axe Perno Пин		
<b>AGE/AMX</b> <b>APR/AQD</b> <b>ATQ/ATX/BBG</b> <b>6 Cyl</b> <b>82.5 mm Bore Ø</b> <b>2,771 cc</b>		Length: 52.28 Outside Ø: Flange Ø: flange depth	Length:	51.98	STD O/S	Top:	1.2	Ø: 21.0 Length: 56.0	
			Comp:	30.16		29.86	2nd:		1.5
			Height:	+1.12		+1.12	3rd:		2.0
			Reference no.:	Reference no.:	Reference no.:	Reference no.:	O-RING		
				<b>K-99942600</b> <b>M-0332200</b>		<b>A-R60310</b> <b>G-0850180000</b> <b>K-800001220000</b> <b>K-800045720000</b> <b>M-03031N0</b> <b>M-03060N0</b> <b>M-03075N0</b> <b>M-03319N0</b> <b>T-50018</b> <b>T-50025</b>			
NM-Germany Article no. Artikelnummer/ Modelo Número / статья НОМЕР	NM-Germany Article no.	NM-Germany Article no.	NM-Germany Article no.	NM-Germany Article no.	NM-Germany Article no.	NM-Germany Article no.	NM-Germany Article no.		
			<b>KBSVW60898G</b>	<b>KBVW60898G</b>	<b>KRVW60898G</b>				

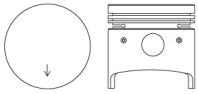

## GASOLINE

ENGINE TYPE Motortyp Type de Moteur Tipo de motor Тип двигателя	LINER KIT Liner Kit Kit de Chemise Camisas de los cilindros лайнер комплект	CYL. LINER Zylinderlaufbuchse Chemise Camisas de los cilindros втулка цилиндра	PISTON + RINGS Kolben + Ringe Piston + Segments Pistón Set Поршень и кольца		PISTON SET Kolben Set Set de Piston Pistón Set поршневой	RINGS SET Kolben Set Segments de Piston Anillos Set кольца	PIN Pin Axe Perno Пин	
<b>AD AS</b> <b>4 Cyl</b> <b>85.5 mm Bore Ø</b> <b>1,584 cc</b>	<b>K-91322970</b>	Length: 136.7 Outside Ø: 90.0 Flange Ø: 93.8 collar depth 112.6	Length:	82.5		Top:	2.0	Ø: 22.0 Length: 72.6
			Comp:	39.5		2nd:	2.0	
			Height:	0		3rd:	5.0	
			Reference no.:	Reference no.:	Reference no.:	Reference no.:	O-RING	
			<b>K-88451110</b> <b>M-029WR07</b> <b>with 19 fins</b>	<b>K-91322701</b> <b>M-0296000</b>		<b>G-0839460000</b> <b>K-800026740000</b> <b>M-02960N0</b>		
NM-Germany Article no. Artikelnummer/ Modelo Número / статья НОМЕР	NM-Germany Article no.	NM-Germany Article no.	NM-Germany Article no.	NM-Germany Article no.	NM-Germany Article no.	NM-Germany Article no.	NM-Germany Article no.	
	<b>LBSVW40899GF</b>	<b>LBVW40899GF</b>	<b>KBSVW40899G</b>	<b>KBVW40899G</b>	<b>KRVW40899G</b>			

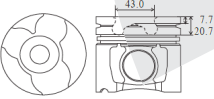

**GASOLINE**

ENGINE TYPE Motortyp Type de Moteur Tipo de motor Тип двигателя	LINER KIT Liner Kit Kit de Chemise Camisas de los cilindros лайнер комплект	CYL. LINER Zylinderlaufbuchse Chemise Camisas de los cilindros втулка цилиндра	PISTON + RINGS Kolben + Ringe Piston + Segments Pistón Set Поршень и кольца			PISTON SET Kolben Set Set de Piston Pistón Set поршневой	RINGS SET Kolben Set Segments de Piston Anillos Set кольца	PIN Pin Axe Perno Пин
<b>124.A</b> 4 Cyl 87.0 mm Bore Ø 1,584 cc 	<b>K-91322971</b> <b>K-91322731</b> <b>K-800026741150</b> <b>K-88656110</b>	Length: 136.8	Length: 82.5			Top: 2.0	Ø: 22.0 Length: 72.6	
		Outside Ø: 90.0	Comp: 39.5			2nd: 2.0		
		Flange Ø: 93.8	Height: 0			3rd: 5.0		
		flange depth 112.6				1st oil: 5.0		
			Reference no.:	Reference no.:	Reference no.:	Reference no.:	O-RING	
NM-Germany Article no. Artikelnummer/ Modelo Número / статья НОМЕР	NM-Germany Article no.	NM-Germany Article no.	NM-Germany Article no.	NM-Germany Article no.	NM-Germany Article no.	NM-Germany Article no.	NM-Germany Article no.	
	LBSVW40900GF	LBVW40900GF	KBSVW40900G	KBVW40900G	KRVW40900G			

**DIESEL**

ENGINE TYPE Motortyp Type de Moteur Tipo de motor Тип двигателя	LINER KIT Liner Kit Kit de Chemise Camisas de los cilindros лайнер комплект	CYL. LINER Zylinderlaufbuchse Chemise Camisas de los cilindros втулка цилиндра	PISTON + RINGS Kolben + Ringe Piston + Segments Pistón Set Поршень и кольца			PISTON SET Kolben Set Set de Piston Pistón Set поршневой	RINGS SET Kolben Set Segments de Piston Anillos Set кольца	PIN Pin Axe Perno Пин
<b>AGK/ATA</b> <b>AUH/BCQ</b> 4 Cyl 93.0 mm Bore Ø 2,798 cc 	<b>K-97412970</b> <b>M-1511090</b>	Length: 183.0	Length: 86.2		alfin	Top: 2.5	Ø: 35.0 Length: 74.0	
		Outside Ø: 96.0	Comp: 56.2			double keystone		
		Flange Ø: 102.5	Height: -7.7			2nd: 2.0		
		flange depth 6.0+1.1	-20.7			3rd: 3.0		
			Reference no.:	Reference no.:	Reference no.:	Reference no.:	O-RING	
			<b>K-89734190</b> <b>M-151WV32</b>	<b>K-97412600</b> <b>K-97412700</b> <b>M-1511000</b>		<b>G-0814300000</b> <b>K-800044340000</b> <b>M-15110N0</b>		
NM-Germany Article no. Artikelnummer/ Modelo Número / статья НОМЕР	NM-Germany Article no.	NM-Germany Article no.	NM-Germany Article no.	NM-Germany Article no.	NM-Germany Article no.	NM-Germany Article no.	NM-Germany Article no.	
	LBSVW40901DSA	LBVW40901DSA	KBSVW40901DA	KBVW40901DA	KRVW40901DA			

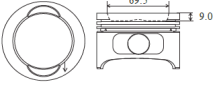
**GASOLINE**

ENGINE TYPE Motortyp Type de Moteur Tipo de motor Тип двигателя	LINER KIT Liner Kit Kit de Chemise Camisas de los cilindros лайнер комплект	CYL. LINER Zylinderlaufbuchse Chemise Camisas de los cilindros втулка цилиндра	PISTON + RINGS Kolben + Ringe Piston + Segments Pistón Set Поршень и кольца			PISTON SET Kolben Set Set de Piston Pistón Set поршневой	RINGS SET Kolben Set Segments de Piston Anillos Set кольца	PIN Pin Axe Perno Пин
<b>DJ</b> 4 Cyl 94.0 mm Bore Ø 2,095 cc 2,109 cc 		Length: 131.8	Length: 66.7			Top: 1.75	Ø: 24.0 Length: 65.0	
		Outside Ø: 100.0	Comp: 36.7			2nd: 2.0		
		Flange Ø: 106.4	Height: -9.0			3rd: 4.0		
		collar depth 96.6				1st oil: 4.0		
			Reference no.:	Reference no.:	Reference no.:	Reference no.:	O-RING	
			<b>K-89168110</b> <b>M-029WN16</b>			<b>K-800027040000</b> <b>M-02965N0</b> <b>G-0839910000</b>	<b>025101177</b> <b>N90168301</b>	
NM-Germany Article no. Artikelnummer/ Modelo Número / статья НОМЕР	NM-Germany Article no.	NM-Germany Article no.	NM-Germany Article no.	NM-Germany Article no.	NM-Germany Article no.	NM-Germany Article no.	NM-Germany Article no.	
	LBSVW40902GF	LBVW40902GF	KBSVW40902G	KBVW40902G	KRVW40902G		<b>ORVW40902G</b>	

**GASOLINE**



ENGINE TYPE Motortyp Type de Moteur Tipo de motor Тип двигателя	LINER KIT Liner Kit Kit de Chemise Camisas de los cilindros лайнер комплект	CYL. LINER Zylinderlaufbuchse Chemise Camisas de los cilindros втулка цилиндра	PISTON + RINGS Kolben + Ringe Piston + Segments Pistón Set Поршень и кольца			PISTON SET Kolben Set Set de Piston Pistón Set поршневой	RINGS SET Kolben Set Segments de Piston Anillos Set кольца	PIN Pin Axe Perno Пин
<b>DF/DG DH/GW</b> 4 Cyl 94.0 mm Bore Ø 1,915 cc	<b>K-93457960 M-0296390</b>	Length: 131.8	Length: 70.2			Top: 1.75	Ø: 24.0 Length: 65.0	
		Outside Ø: 100.0	Comp: 40.2			2nd: 2.0		
		Flange Ø: 106.4	Height: -11.6			3rd: 4.0		
		collar depth 96.6				1st oil: 4.0		
		Reference no.:		Reference no.:	Reference no.:	Reference no.:	O-RING	
		<b>K-89168110 M-029WN16</b>		<b>K-93457600 M-0296300</b>		<b>K-800027040000 M-02965N0 G-0839910000</b>	<b>025101177 N90168301</b>	
NM-Germany Article no. Artikelnummer/ Modelo Número / статья НОМЕР	NM-Germany Article no.	NM-Germany Article no.	NM-Germany Article no.	NM-Germany Article no.	NM-Germany Article no.	NM-Germany Article no.	NM-Germany Article no.	
	<b>LBSVW40903GF</b>	<b>LBVW40903GF</b>	<b>KBSVW40903G</b>	<b>KBVW40903G</b>	<b>KRVW40903G</b>	<b>ORVW40903G</b>		

VW

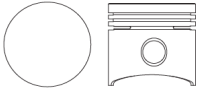

**GASOLINE**

ENGINE TYPE Motortyp Type de Moteur Tipo de motor Тип двигателя	LINER KIT Liner Kit Kit de Chemise Camisas de los cilindros лайнер комплект	CYL. LINER Zylinderlaufbuchse Chemise Camisas de los cilindros втулка цилиндра	PISTON + RINGS Kolben + Ringe Piston + Segments Pistón Set Поршень и кольца			PISTON SET Kolben Set Set de Piston Pistón Set поршневой	RINGS SET Kolben Set Segments de Piston Anillos Set кольца	PIN Pin Axe Perno Пин
<b>DJ</b> 4 Cyl 94.0 mm Bore Ø 2,095 cc 2,109 cc	<b>K-90129970 M-0297290</b>	Length: 131.8	Length: 66.7			Top: 1.75	Ø: 24.0 Length: 65.0	
		Outside Ø: 100.0	Comp: 36.7			2nd: 2.0		
		Flange Ø: 106.4	Height: -9.0			3rd: 3.5		
		collar depth 96.6				1st oil: 3.5		
		Reference no.:		Reference no.:	Reference no.:	Reference no.:	O-RING	
		<b>K-89168110 M-029WN16</b>		<b>K-90129700 M-0297200</b>		<b>K-800026941000 M-02972N0 G-089900000</b>	<b>025101177 N90168301</b>	
NM-Germany Article no. Artikelnummer/ Modelo Número / статья НОМЕР	NM-Germany Article no.	NM-Germany Article no.	NM-Germany Article no.	NM-Germany Article no.	NM-Germany Article no.	NM-Germany Article no.	NM-Germany Article no.	
	<b>LBSVW40904GF</b>	<b>LBVW40904GF</b>	<b>KBSVW40904G</b>	<b>KBVW40904G</b>	<b>KRVW40904G</b>	<b>ORVW40904G</b>		



**GASOLINE**

ENGINE TYPE Motortyp Type de Moteur Tipo de motor Тип двигателя	LINER KIT Liner Kit Kit de Chemise Camisas de los cilindros лайнер комплект	CYL. LINER Zylinderlaufbuchse Chemise Camisas de los cilindros втулка цилиндра	PISTON + RINGS Kolben + Ringe Piston + Segments Pistón Set Поршень и кольца		PISTON SET Kolben Set Set de Piston Pistón Set поршневой	RINGS SET Kolben Set Segments de Piston Anillos Set кольца	PIN Pin Axe Perno Пин
<b>B 10.E</b> 4 Cyl 70.0 mm Bore Ø 1,108 cc 	<b>K-93695970</b> <b>M-0217580</b>	Length: 135.0 Outside Ø: 75.5 Flange Ø: 85.8 collar depth 94.85	Length: 68.0 Comp: 40.0 Height: 0			Top: 1.75 2nd: 2.0 3rd: 3.5 1st oil: 2nd oil:	Ø: 18.0 Length: 62.0
		Reference no.:	Reference no.:	Reference no.:	Reference no.:	O-RING	
		<b>K-88384110</b> <b>M-021WN08</b>	<b>K-93695700</b> <b>M-0217510</b>		<b>A-R66160</b> <b>G-0833460000</b> <b>K-800004240000</b> <b>M-02175V0</b>	<b>K-50006646</b>	
NM-Germany Article no. Artikelnummer/ Modelo Número / статья НОМЕР	NM-Germany Article no.	NM-Germany Article no.	NM-Germany Article no.	NM-Germany Article no.	NM-Germany Article no.	NM-Germany Article no.	NM-Germany Article no.
	LBSVO40905GF	LBVO40905GF	KBSVO40905G	KBVO40905G	KRVO40905G	ORVO40905G	

**GASOLINE**

ENGINE TYPE Motortyp Type de Moteur Tipo de motor Тип двигателя	LINER KIT Liner Kit Kit de Chemise Camisas de los cilindros лайнер комплект	CYL. LINER Zylinderlaufbuchse Chemise Camisas de los cilindros втулка цилиндра	PISTON + RINGS Kolben + Ringe Piston + Segments Pistón Set Поршень и кольца		PISTON SET Kolben Set Set de Piston Pistón Set поршневой	RINGS SET Kolben Set Segments de Piston Anillos Set кольца	PIN Pin Axe Perno Пин
<b>B 14</b> <b>B 14.E</b> 4 Cyl 76.0 mm Bore Ø 1,397 cc 	<b>A-SA2516</b> <b>K-93696970</b> <b>M-0217880</b> <b>N-8933350000</b>	Length: 134.0 Outside Ø: 80.52 Flange Ø: 90.15 collar depth 95.0	Length: 64.0 Comp: 37.4 Height: 0			Top: 1.75 2nd: 2.0 3rd: 4.0 1st oil: 2nd oil:	Ø: 20.0 Length: 64.0
		Reference no.:	Reference no.:	Reference no.:	Reference no.:	O-RING	
		<b>A-SJ4326</b> <b>G-1563082000</b> <b>K-89060110</b> <b>M-021WN23</b>	<b>K-93696700</b> <b>M-0217810</b>		<b>A-R66190</b> <b>G-0833350000</b> <b>K-800023040000</b> <b>M-02178N0</b>		
NM-Germany Article no. Artikelnummer/ Modelo Número / статья НОМЕР	NM-Germany Article no.	NM-Germany Article no.	NM-Germany Article no.	NM-Germany Article no.	NM-Germany Article no.	NM-Germany Article no.	NM-Germany Article no.
	LBSVO40906GF	LBVO40906GF	KBSVO40906G	KBVO40906G	KRVO40906G	ORVO40906G	

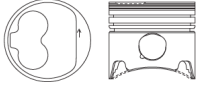
**DIESEL**

ENGINE TYPE Motortyp Type de Moteur Tipo de motor Тип двигателя	LINER KIT Liner Kit Kit de Chemise Camisas de los cilindros лайнер комплект	CYL. LINER Zylinderlaufbuchse Chemise Camisas de los cilindros втулка цилиндра	PISTON + RINGS Kolben + Ringe Piston + Segments Pistón Set Поршень и кольца		PISTON SET Kolben Set Set de Piston Pistón Set поршневой	RINGS SET Kolben Set Segments de Piston Anillos Set кольца	PIN Pin Axe Perno Пин
<b>D 24 TD TURBO</b> <b>D 24 TIC TURBO</b> 6 Cyl 76.5 mm Bore Ø 2,383 cc 	<b>K-90732960</b> <b>M-0297990</b>	Length: 145.0 Outside Ø: 79.5 Flange Ø: 81.5 flange depth 4.7	Length: 71.7 Comp: 41.7 Height: -1.6	STD O/S 71.45 41.45 -1.6 -1.6	alfin head anodized fits tapered con. rod	Top: 1.75 2nd: 2.0 3rd: 3.0 1st oil: 2nd oil:	Ø: 24.0 Length: 64.0
		Reference no.:	Reference no.:	Reference no.:	Reference no.:	O-RING	
		<b>G-140283600</b> <b>K-89163190</b> <b>M-029WV13</b>	<b>K-90732600</b> <b>M-0297900</b> <b>N-8710980010</b>		<b>A-R43850</b> <b>A-R45270</b> <b>G-0810950000</b> <b>G-0810980000</b> <b>K-80000610000</b> <b>M-02954/55N0</b>		
NM-Germany Article no. Artikelnummer/ Modelo Número / статья НОМЕР	NM-Germany Article no.	NM-Germany Article no.	NM-Germany Article no.	NM-Germany Article no.	NM-Germany Article no.	NM-Germany Article no.	NM-Germany Article no.
	LBSVO60907DSA	LBVO60907DSA	KBSVO60907DA	KBVO60907DA	KRVO60907DA		



**DIESEL**

ENGINE TYPE Motortyp Type de Moteur Tipo de motor Тип двигателя	LINER KIT Liner Kit Kit de Chemise Camisas de los cilindros лайнер комплект	CYL. LINER Zylinderlaufbuchse Chemise Camisas de los cilindros втулка цилиндра	PISTON + RINGS Kolben + Ringe Piston + Segments Pistón Set Поршень и кольца			PISTON SET Kolben Set Set de Piston Pistón Set поршневой	RINGS SET Kolben Set Segments de Piston Anillos Set кольца	PIN Pin Axe Perno Пин				
<b>D 24</b> 6 Cyl 76.5 mm Bore Ø 2,383 cc	<b>K-93260960</b> <b>M-0295590</b>	Length: 145.0 Outside Ø: 79.5 Flange Ø: 81.5 flange depth 4.7	Length: 71.7 Comp: 41.7 Height: -1.6		alfin	Top: 1.75 2nd: 2.0 3rd: 3.0 1st oil: 2nd oil:	Ø: 24.0 Length: 64.0					
								Reference no.:	Reference no.:	Reference no.:	Reference no.:	O-RING
								<b>G-140283600</b> <b>K-89163190</b> <b>M-029WV13</b>	<b>K-93260600</b> <b>M-0295500</b> <b>N-8710950000</b>	<b>272 032</b> <b>272 072</b>	<b>A-R43850</b> <b>A-R45270</b> <b>G-0810950000</b> <b>G-0810980000</b> <b>K-800000610000</b> <b>M-02954/55N0</b>	
NM-Germany Article no. Artikelnummer/ Modelo Número / статья НОМЕР	NM-Germany Article no.	NM-Germany Article no.	NM-Germany Article no.	NM-Germany Article no.	NM-Germany Article no.	NM-Germany Article no.	NM-Germany Article no.					
	<b>LBSVO60908DSA</b>	<b>LBVO60908DSA</b>	<b>KBSVO60908DA</b>	<b>KBVO60908DA</b>	<b>KRVO60908DA</b>							

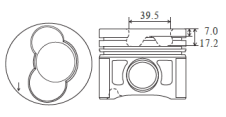

ENGINE TYPE Motortyp Type de Moteur Tipo de motor Тип двигателя	LINER KIT Liner Kit Kit de Chemise Camisas de los cilindros лайнер комплект	CYL. LINER Zylinderlaufbuchse Chemise Camisas de los cilindros втулка цилиндра	PISTON + RINGS Kolben + Ringe Piston + Segments Pistón Set Поршень и кольца			PISTON SET Kolben Set Set de Piston Pistón Set поршневой	RINGS SET Kolben Set Segments de Piston Anillos Set кольца	PIN Pin Axe Perno Пин				
<b>D 19 T</b> <b>D 4192 T</b> 4 Cyl 80.0 mm Bore Ø 1,870 cc		Length: 154.0 Outside Ø: 83.05 Flange Ø: 86.0 flange depth 5.0	Length: 66.69 Comp: 41.71 Height: -0.8 -1.7		alfin and with oil gallery	Top: 2.5 2nd: 2.0 3rd: 3.0 1st oil: 2nd oil:	Ø: 26.0 Length: 66.5					
								Reference no.:	Reference no.:	Reference no.:	Reference no.:	O-RING
									<b>A-A350542</b> <b>N-8710350000</b>		<b>A-R60260</b> <b>G-0810150000</b> <b>K-800036140000</b> <b>M-02158V0</b>	
NM-Germany Article no. Artikelnummer/ Modelo Número / статья НОМЕР	NM-Germany Article no.	NM-Germany Article no.	NM-Germany Article no.	NM-Germany Article no.	NM-Germany Article no.	NM-Germany Article no.	NM-Germany Article no.					
	<b>LBSVO40909DSB</b>	<b>LBVO40909DSB</b>	<b>KBSVO40909DB</b>	<b>KBVO40909DB</b>	<b>KRVO40909DB</b>							

VOLVO

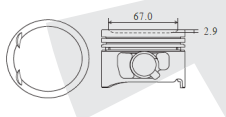

ENGINE TYPE Motortyp Type de Moteur Tipo de motor Тип двигателя	LINER KIT Liner Kit Kit de Chemise Camisas de los cilindros лайнер комплект	CYL. LINER Zylinderlaufbuchse Chemise Camisas de los cilindros втулка цилиндра	PISTON + RINGS Kolben + Ringe Piston + Segments Pistón Set Поршень и кольца			PISTON SET Kolben Set Set de Piston Pistón Set поршневой	RINGS SET Kolben Set Segments de Piston Anillos Set кольца	PIN Pin Axe Perno Пин				
<b>D 5252 T</b> 5 Cyl 81.0 mm Bore Ø 2,461 cc	<b>(A)</b> consists of (C)  <b>(B)</b> consists of (D)	Length: 158.0 Outside Ø: 84.0 Flange Ø: 86.0 flange depth 4.0	Length: 158.0 Comp: 41.71 Height: 4.0		alfin skirt MOS2 treated pin bushing inserted pin boss gap=22.2mm	Top: 2.5 2nd: 2.0 3rd: 3.0 1st oil: 2nd oil:	Ø: 26.0 Length: 68.0					
								Reference no.:	Reference no.:	Reference no.:	Reference no.:	O-RING
									<b>K-94429700</b> <b>M-0349000</b> <b>N-8750150020</b>		<b>A-R60330</b> <b>G-0842100000</b> <b>G-0850150000</b> <b>K-800001150000</b> <b>K-800073910000</b> <b>M-03048N0</b> <b>M-03490N0</b>	
NM-Germany Article no. Artikelnummer/ Modelo Número / статья НОМЕР	NM-Germany Article no.	NM-Germany Article no.	NM-Germany Article no.	NM-Germany Article no.	NM-Germany Article no.	NM-Germany Article no.	NM-Germany Article no.					
	<b>LSBVO50910DPA (A)</b> <b>LSBVO50910DSA (B)</b> (for cyl 1/2)	<b>LBVO50910DPA (C)</b> <b>LBVO50910DSA (D)</b>	<b>KBSVO50910DA</b> (for cyl 1/2)	<b>KBVO50910DA</b> (for cyl 1/2)	<b>KRVO50910DA</b>							

ENGINE TYPE Motortyp Type de Moteur Tipo de motor Тип двигателя	LINER KIT Liner Kit Kit de Chemise Camisas de los cilindros лайнер комплект	CYL. LINER Zylinderlaufbuchse Chemise Camisas de los cilindros втулка цилиндра	PISTON + RINGS Kolben + Ringe Piston + Segments Pistón Set Поршень и кольца	PISTON SET Kolben Set Set de Piston Pistón Set поршневой	RINGS SET Kolben Set Segments de Piston Anillos Set кольца	PIN Pin Axe Perno Пин
<b>D 5252 T</b> 5 Cyl 81.0 mm Bore Ø 2,461 cc 	<b>(A) consists of (C)</b>  <b>(B) consists of (D)</b>	Length: 158.0 158.0 Outside Ø: 84.0 84.0 Flange Ø: 86.0 flange depth 4.0	Length: Comp: Height:	alfin skirt MOS2 treated pin bushing inserted pin boss gap=22.2mm	Top: 2nd: 3rd: 1st oil: 2nd oil:	Ø: Length:
		Reference no.:	Reference no.:	Reference no.:	Reference no.:	O-RING
			<b>K-94430700</b> <b>M-0349100</b> <b>N-8750150030</b>		<b>A-R60330</b> <b>G-0842100000</b> <b>G-0850150000</b> <b>K-800001150000</b> <b>K-800073910000</b> <b>M-03048N0</b> <b>M-03490N0ZZ</b>	
NM-Germany Article no. Artikelnummer/ Modelo Número / статья НОМЕР	NM-Germany Article no.	NM-Germany Article no.	NM-Germany Article no.	NM-Germany Article no.	NM-Germany Article no.	NM-Germany Article no.
	LBSVO50911DPA(A) LBSVO50911DPA(B) (for cyl 3/4/5)	LBVO5091DA (C) LBVO5091DA (D)	KRVO50911DA (for cyl 3/4/5)	KBVO50911DA (for cyl 3/4/5)	KRVO50911DA	

## GASOLINE

ENGINE TYPE Motortyp Type de Moteur Tipo de motor Тип двигателя	LINER KIT Liner Kit Kit de Chemise Camisas de los cilindros лайнер комплект	CYL. LINER Zylinderlaufbuchse Chemise Camisas de los cilindros втулка цилиндра	PISTON + RINGS Kolben + Ringe Piston + Segments Pistón Set Поршень и кольца	PISTON SET Kolben Set Set de Piston Pistón Set поршневой	RINGS SET Kolben Set Segments de Piston Anillos Set кольца	PIN Pin Axe Perno Пин
<b>B 5204.T3 TURBO</b> <b>B 5234.T3 TURBO</b> 5 Cyl 81.0 mm Bore Ø 1,984 cc 2,319 cc 		Length: Outside Ø: Flange Ø: flange depth	Length: 60.0 Comp: 36.0 Height: -2.9		Top: 1.5 2nd: 1.75 3rd: 1st oil: 3.0 2nd oil:	Ø: 23.0 Length: 66.0
		Reference no.:	Reference no.:	Reference no.:	Reference no.:	O-RING
			M-0382400	272 142	M-03824N0	
NM-Germany Article no. Artikelnummer/ Modelo Número / статья НОМЕР	NM-Germany Article no.	NM-Germany Article no.	NM-Germany Article no.	NM-Germany Article no.	NM-Germany Article no.	NM-Germany Article no.
			KBSVO50912G	KBVO50912G	KRVO50912G	

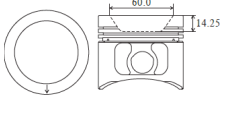
## GASOLINE

ENGINE TYPE Motortyp Type de Moteur Tipo de motor Тип двигателя	LINER KIT Liner Kit Kit de Chemise Camisas de los cilindros лайнер комплект	CYL. LINER Zylinderlaufbuchse Chemise Camisas de los cilindros втулка цилиндра	PISTON + RINGS Kolben + Ringe Piston + Segments Pistón Set Поршень и кольца	PISTON SET Kolben Set Set de Piston Pistón Set поршневой	RINGS SET Kolben Set Segments de Piston Anillos Set кольца	PIN Pin Axe Perno Пин
<b>B 18.E/B 18.ED</b> <b>B 18.EP/B 18.F</b> <b>B 18.FP/F3N</b> 4 Cyl 81.0 mm Bore Ø 1,721 cc 		Length: Outside Ø: Flange Ø: flange depth	Length: 70.2 Comp: 44.2 Height: -14.25		Top: 1.75 2nd: 2.0 3rd: 1st oil: 3.0 2nd oil:	Ø: 21.0 Length: 65.0
		Reference no.:	Reference no.:	Reference no.:	Reference no.:	O-RING
			<b>K-90364600</b> <b>M-0218300</b> <b>M-0219500</b> <b>M-0219600</b>		<b>A-R66260</b> <b>G-0833510000</b> <b>K-800023340000</b> <b>M-02182N0</b>	
NM-Germany Article no. Artikelnummer/ Modelo Número / статья НОМЕР	NM-Germany Article no.	NM-Germany Article no.	NM-Germany Article no.	NM-Germany Article no.	NM-Germany Article no.	NM-Germany Article no.
			KBSVO40913G	KBVO40913G	KRVO40913G	

**GASOLINE**



ENGINE TYPE Motortyp Type de Moteur Tipo de motor Тип двигателя	LINER KIT Liner Kit Kit de Chemise Camisas de los cilindros лайнер комплект	CYL. LINER Zylinderlaufbuchse Chemise Camisas de los cilindros втулка цилиндра	PISTON + RINGS Kolben + Ringe Piston + Segments Pistón Set Поршень и кольца			PISTON SET Kolben Set Set de Piston Pistón Set поршневой	RINGS SET Kolben Set Segments de Piston Anillos Set кольца	PIN Pin Axe Perno Пин
<b>F3P 700/765</b> 4 Cyl 82.7 mm Bore Ø 1,794 cc		Length: Outside Ø: Flange Ø: flange depth	Length:	60.0	skirt MOS2 treated	Top:	1.5	Ø: 21.0 Length: 65.0
			Comp:	33.55		2nd:	1.75	
			Height:	-2.98		3rd:	3.0	
			Reference no.:	Reference no.:	Reference no.:	Reference no.:	O-RING	
				<b>K-94440600</b> <b>M-0216100</b>		<b>A-R67580</b> <b>G-0833740000</b> <b>M-02162N0</b>		
NM-Germany Article no. Artikelnummer/ Modelo Número / статья НОМЕР	NM-Germany Article no.	NM-Germany Article no.	NM-Germany Article no.	NM-Germany Article no.	NM-Germany Article no.	NM-Germany Article no.	NM-Germany Article no.	
			<b>KBSVO40914G</b>	<b>KBVO40914G</b>	<b>KRVO40914G</b>			

ENGINE TYPE Motortyp Type de Moteur Tipo de motor Тип двигателя	LINER KIT Liner Kit Kit de Chemise Camisas de los cilindros лайнер комплект	CYL. LINER Zylinderlaufbuchse Chemise Camisas de los cilindros втулка цилиндра	PISTON + RINGS Kolben + Ringe Piston + Segments Pistón Set Поршень и кольца			PISTON SET Kolben Set Set de Piston Pistón Set поршневой	RINGS SET Kolben Set Segments de Piston Anillos Set кольца	PIN Pin Axe Perno Пин
<b>B 20 F 208</b> 4 Cyl 82.7 mm Bore Ø 1,998 cc		Length: Outside Ø: Flange Ø: flange depth	Length:	60.0	skirt MOS2 treated	Top:	1.5	Ø: 21.0 Length: 57.0
			Comp:	36.1		2nd:	1.75	
			Height:	-9.0		3rd:	3.0	
			Reference no.:	Reference no.:	Reference no.:	Reference no.:	O-RING	
				<b>K-94442600</b> <b>M-0216200</b>		<b>A-R67580</b> <b>G-0833740000</b> <b>M-02162N0</b>		
NM-Germany Article no. Artikelnummer/ Modelo Número / статья НОМЕР	NM-Germany Article no.	NM-Germany Article no.	NM-Germany Article no.	NM-Germany Article no.	NM-Germany Article no.	NM-Germany Article no.	NM-Germany Article no.	
			<b>KBSVO40915G</b>	<b>KBVO40915G</b>	<b>KRVO40915G</b>			

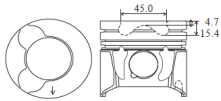

VOLVO

ENGINE TYPE Motortyp Type de Moteur Tipo de motor Тип двигателя	LINER KIT Liner Kit Kit de Chemise Camisas de los cilindros лайнер комплект	CYL. LINER Zylinderlaufbuchse Chemise Camisas de los cilindros втулка цилиндра	PISTON + RINGS Kolben + Ringe Piston + Segments Pistón Set Поршень и кольца			PISTON SET Kolben Set Set de Piston Pistón Set поршневой	RINGS SET Kolben Set Segments de Piston Anillos Set кольца	PIN Pin Axe Perno Пин
<b>B 5244</b> <b>B 5254</b> 5 Cyl 83.0 mm Bore Ø 2,435 cc		Length: Outside Ø: Flange Ø: flange depth	Length:	52.4		Top:	1.2	Ø: 21.0 Length: 57.0
			Comp:	28.0		2nd:	1.5	
			Height:	2.4		3rd:	2.5	
			Reference no.:	Reference no.:	Reference no.:	Reference no.:	O-RING	
				<b>K-99659600</b>		<b>A-R67530</b> <b>G-0810250000</b> <b>K-800057910000</b>		
NM-Germany Article no. Artikelnummer/ Modelo Número / статья НОМЕР	NM-Germany Article no.	NM-Germany Article no.	NM-Germany Article no.	NM-Germany Article no.	NM-Germany Article no.	NM-Germany Article no.	NM-Germany Article no.	
			<b>KBSVO50916G</b>	<b>KBVO50916G</b>	<b>KRVO50916G</b>			

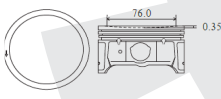

**DIESEL**

ENGINE TYPE Motortyp Type de Moteur Tipo de motor Тип двигателя	LINER KIT Liner Kit Kit de Chemise Camisas de los cilindros лайнер комплект	CYL. LINER Zylinderlaufbuchse Chemise Camisas de los cilindros втулка цилиндра	PISTON + RINGS Kolben + Ringe Piston + Segments Pistón Set Поршень и кольца		PISTON SET Kolben Set Set de Piston Pistón Set поршневой	RINGS SET Kolben Set Segments de Piston Anillos Set кольца	PIN Pin Axe Perno Пин
<b>D 4204 T</b> 4 Cyl 85.0 mm Bore Ø 1,998 cc	<b>K-99700600</b> <b>A-R60410</b> <b>G-0811470000</b> <b>K-800045940000</b> <b>M-03999N0</b>	Length: 165.0 Outside Ø: 89.06 Flange Ø: 91.0 flange depth 4.5	Length: 80.7 Comp: 46.7 Height: -4.7 -15.4		alfin and with oil gallery skirt MOS2 treated fits tapered con. rod	Top: 3.5 double key-stone 2nd: 2.0 3rd: 1st oil: 3.0 2nd oil:	Ø: 28.0 Length: 70.0
Reference no.:		Reference no.:		Reference no.:	Reference no.:	O-RING	
							
NM-Germany Article no. Artikelnummer/ Modelo Número / статья НОМЕР	NM-Germany Article no.	NM-Germany Article no.	NM-Germany Article no.	NM-Germany Article no.	NM-Germany Article no.	NM-Germany Article no.	
	LBSVO40917DSB	LBVO40917DSB	KBSVO40917DB	KBVO40917DB	KRVO40917DB		

**GASOLINE**

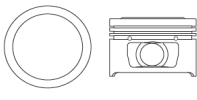

ENGINE TYPE Motortyp Type de Moteur Tipo de motor Тип двигателя	LINER KIT Liner Kit Kit de Chemise Camisas de los cilindros лайнер комплект	CYL. LINER Zylinderlaufbuchse Chemise Camisas de los cilindros втулка цилиндра	PISTON + RINGS Kolben + Ringe Piston + Segments Pistón Set Поршень и кольца		PISTON SET Kolben Set Set de Piston Pistón Set поршневой	RINGS SET Kolben Set Segments de Piston Anillos Set кольца	PIN Pin Axe Perno Пин
<b>B 4204 S3</b> 4 Cyl 87.5 mm Bore Ø 1,999 cc			STD O/S Length: 51.0 51.0 Comp: 28.5 28.5 Height: -0.35 -0.58		head, top and 2nd ring lands anodized skirt MOS2 treated	Top: 1.2 2nd: 1.2 3rd: 1st oil: 2.5 2nd oil:	Ø: 21.0 Length: 60.0
Reference no.:		Reference no.:		Reference no.:	Reference no.:	O-RING	
			<b>K-99457600</b>		<b>K-800044940000</b> <b>M-01561N0</b>		
NM-Germany Article no. Artikelnummer/ Modelo Número / статья НОМЕР	NM-Germany Article no.	NM-Germany Article no.	NM-Germany Article no.	NM-Germany Article no.	NM-Germany Article no.	NM-Germany Article no.	
			KBSVO40918G	KBVO40918G	KRVO40918G		

**GASOLINE**



ENGINE TYPE Motortyp Type de Moteur Tipo de motor Тип двигателя	LINER KIT Liner Kit Kit de Chemise Camisas de los cilindros лайнер комплект	CYL. LINER Zylinderlaufbuchse Chemise Camisas de los cilindros втулка цилиндра	PISTON + RINGS Kolben + Ringe Piston + Segments Pistón Set Поршень и кольца		PISTON SET Kolben Set Set de Piston Pistón Set поршневой	RINGS SET Kolben Set Segments de Piston Anillos Set кольца	PIN Pin Axe Perno Пин
<b>B 27.A</b> <b>B 27.E</b> 6 Cyl 88.0 mm Bore Ø 2,664 cc	<b>M-0395590</b>	Length: 131.9 Outside Ø: 93.5 Flange Ø: 102.2 collar depth 99.13	Length: 63.3 Comp: 38.45 Height: 1.1			Top: 1.5 2nd: 2.0 3rd: 1st oil: 4.0 2nd oil:	Ø: 23.5 Length: 72.0
Reference no.:		Reference no.:		Reference no.:	Reference no.:	O-RING	
			<b>K-92875600</b> <b>M-0395500</b>		<b>A-R66110</b> <b>G-0831690000</b> <b>K-800003841000</b> <b>M-03953N0</b> <b>T-50023</b>	<b>ORVO60919G</b>	
NM-Germany Article no. Artikelnummer/ Modelo Número / статья НОМЕР	NM-Germany Article no.	NM-Germany Article no.	NM-Germany Article no.	NM-Germany Article no.	NM-Germany Article no.	NM-Germany Article no.	
	LBSVO60919GF	LBVO60919GF	KBSVO60919G	KBVO60919G	KRVO60919G		

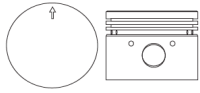

**GASOLINE**

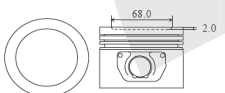

ENGINE TYPE Motortyp Type de Moteur Tipo de motor Тип двигателя	LINER KIT Liner Kit Kit de Chemise Camisas de los cilindros лайнер комплект	CYL. LINER Zylinderlaufbuchse Chemise Camisas de los cilindros втулка цилиндра	PISTON + RINGS Kolben + Ringe Piston + Segments Pistón Set Поршень и кольца			PISTON SET Kolben Set Set de Piston Pistón Set поршневой	RINGS SET Kolben Set Segments de Piston Anillos Set кольца	PIN Pin Axe Perno Пин				
<b>B 19.E/B 20.A/B 20.B B 20.E/B 20.F B 30.A/B 30.E</b>		Length: Outside Ø: Flange Ø: flange depth	Length: Comp: Height:	71.0 46.0 0		Top: 2.0 2nd: 2.0 3rd: 1st oil: 4.75 2nd oil:	Ø: 22.0 Length: 79.0					
								Reference no.:	Reference no.:	Reference no.:	Reference no.:	O-RING
									<b>H-20614V1 K-91509600 M-0373100</b>	<b>272 002</b>	<b>A-R40190 A-R40100 G-0840690010 K-800027220000 M-03731N0</b>	
<b>Cyl 4/6 88.9 mm Bore Ø 1,986 cc 2,978 cc</b>												
												
NM-Germany Article no. Artikelnummer/ Modelo Número / статья НОМЕР	NM-Germany Article no.	NM-Germany Article no.	NM-Germany Article no.	NM-Germany Article no.	NM-Germany Article no.	NM-Germany Article no.	NM-Germany Article no.					
			<b>KBSVO0920G</b>	<b>KBVO0920G</b>	<b>KRVO0920G</b>							

**GASOLINE**

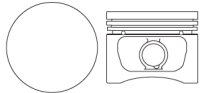

ENGINE TYPE Motortyp Type de Moteur Tipo de motor Тип двигателя	LINER KIT Liner Kit Kit de Chemise Camisas de los cilindros лайнер комплект	CYL. LINER Zylinderlaufbuchse Chemise Camisas de los cilindros втулка цилиндра	PISTON + RINGS Kolben + Ringe Piston + Segments Pistón Set Поршень и кольца			PISTON SET Kolben Set Set de Piston Pistón Set поршневой	RINGS SET Kolben Set Segments de Piston Anillos Set кольца	PIN Pin Axe Perno Пин				
<b>B 21.A B 21.E</b>		Length: Outside Ø: Flange Ø: flange depth	Length: Comp: Height:	71.0 46.0 -2.0		Top: 1.75 2nd: 2.0 3rd: 1st oil: 4.0 2nd oil:	Ø: 24.0 Length: 72.0					
								Reference no.:	Reference no.:	Reference no.:	Reference no.:	O-RING
									<b>K-92776600 M-0373500</b>	<b>272 013 272 044 272 045</b>	<b>A-R34136 G-0840760010 K-800027340000 M-03735N0</b>	
<b>4 Cyl 92.0 mm Bore Ø 2,112 cc</b>												
												
NM-Germany Article no. Artikelnummer/ Modelo Número / статья НОМЕР	NM-Germany Article no.	NM-Germany Article no.	NM-Germany Article no.	NM-Germany Article no.	NM-Germany Article no.	NM-Germany Article no.	NM-Germany Article no.					
			<b>KBSVO40921G</b>	<b>KBVO40921G</b>	<b>KRVO40921G</b>							

VOLVO

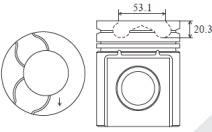

**GASOLINE**

ENGINE TYPE Motortyp Type de Moteur Tipo de motor Тип двигателя	LINER KIT Liner Kit Kit de Chemise Camisas de los cilindros лайнер комплект	CYL. LINER Zylinderlaufbuchse Chemise Camisas de los cilindros втулка цилиндра	PISTON + RINGS Kolben + Ringe Piston + Segments Pistón Set Поршень и кольца			PISTON SET Kolben Set Set de Piston Pistón Set поршневой	RINGS SET Kolben Set Segments de Piston Anillos Set кольца	PIN Pin Axe Perno Пин				
<b>B 23.A B 23.E</b>		Length: Outside Ø: Flange Ø: flange depth	Length: Comp: Height:	76.4 46.4 0		Top: 1.75 2nd: 2.0 3rd: 1st oil: 4.0 2nd oil:	Ø: 24.0 Length: 72.0					
								Reference no.:	Reference no.:	Reference no.:	Reference no.:	O-RING
									<b>K-93476600 M-0374200</b>	<b>272 036</b>	<b>A-R34156 G-0840770010 K-800027541000 M-03742N0</b>	
<b>4 Cyl 96.0 mm Bore Ø 2,316 cc</b>												
												
NM-Germany Article no. Artikelnummer/ Modelo Número / статья НОМЕР	NM-Germany Article no.	NM-Germany Article no.	NM-Germany Article no.	NM-Germany Article no.	NM-Germany Article no.	NM-Germany Article no.	NM-Germany Article no.					
			<b>KBSVO40922G</b>	<b>KBVO40922G</b>	<b>KRVO40922G</b>							

**DIESEL**

ENGINE TYPE	LINER KIT	CYL. LINER	PISTON + RINGS			PISTON SET	RINGS SET	PIN
Motortyp Type de Moteur Tipo de motor Тип двигателя	Liner Kit Kit de Chemise Camisas de los cilindros лайнер комплект	Zylinderlaufbuchse Chemise Camisas de los cilindros втулка цилиндра	Kolben + Ringe Piston + Segments Pistón Set Поршень и кольца			Kolben Set Set de Piston Pistón Set поршеньой	Kolben Set Segments de Piston Anillos Set кольца	Pin Axe Perno Пин
<b>TD63E/ES TURBO</b> <b>TD63KBE/KDE TURBO</b> <b>TD63KEE/KFE TURBO</b>  <b>6 Cyl</b> <b>98.43 mm Bore Ø</b> <b>5,480 cc</b>	<b>A-ASA2321</b> <b>K-99991970</b> <b>M-0383490</b>	Length: 237.4 Outside Ø: 110.0 Flange Ø: 119.1 flange depth 9.66 +3.6	Length: 124.4 Comp: 79.4 Height: -20.3			alfin fits tapered con. rod	Top: 3.5 double key-stone 2nd: 2.5 3rd: 3.5 1st oil: 2nd oil:	Ø: 40.0 Length: 77.3
		Reference no.: <b>A-SJ351349</b> <b>G-1545934000</b> <b>K-89578110</b> <b>M-037WN47</b>	Reference no.: <b>A-A350835</b> <b>K-99991700</b> <b>M-0383400</b> <b>N-8714250000</b>				Reference no.: <b>A-R45750</b> <b>G-0814250000</b> <b>K-800042210000</b> <b>M-03838N0</b>	O-RING <b>ORVO60923DA</b>
NM-Germany Article no. Artikelnummer/ Modelo Número / статья НОМЕР	NM-Germany Article no.	NM-Germany Article no.	NM-Germany Article no.	NM-Germany Article no.	NM-Germany Article no.	NM-Germany Article no.	NM-Germany Article no.	NM-Germany Article no.
	LBSVO60923DFA	LBVO60923DFA	KBSVO60923DA	KBVO60923DA	KBVO60923DA	KRVO60923DA		

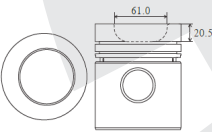
**DIESEL**

ENGINE TYPE	LINER KIT	CYL. LINER	PISTON + RINGS			PISTON SET	RINGS SET	PIN
Motortyp Type de Moteur Tipo de motor Тип двигателя	Liner Kit Kit de Chemise Camisas de los cilindros лайнер комплект	Zylinderlaufbuchse Chemise Camisas de los cilindros втулка цилиндра	Kolben + Ringe Piston + Segments Pistón Set Поршень и кольца			Kolben Set Set de Piston Pistón Set поршеньой	Kolben Set Segments de Piston Anillos Set кольца	Pin Axe Perno Пин
<b>4.236</b> <b>4 Cyl</b> <b>98.48 mm Bore Ø</b> <b>3,864 cc</b>	<b>K-93592962</b>	Length: 227.4 Outside Ø: 103.22 Flange Ø: 106.36 flange depth 3.8 +1.0	Length: 121.0 Comp: 70.3 Height: -20.5			alfin head anodized skirt MOS2 treated	Top: 2.385 2nd: 2.385 3rd: 4.747 1st oil: 2nd oil:	Ø: 34.93 Length: 84.0
		Reference no.: <b>K-88355190</b> <b>M-043WV12</b>	Reference no.: <b>K-93592600</b> <b>M-0433100</b>				Reference no.: <b>A-R34740</b> <b>G-0831890010</b> <b>K-800033710000</b> <b>M-04331N0</b>	
NM-Germany Article no. Artikelnummer/ Modelo Número / статья НОМЕР	NM-Germany Article no.	NM-Germany Article no.	NM-Germany Article no.	NM-Germany Article no.	NM-Germany Article no.	NM-Germany Article no.	NM-Germany Article no.	NM-Germany Article no.
	LBSVO40924DSA	LBVO40924DSA	KBSVO40924DA	KBVO40924DA	KBVO40924DA	KRVO40924DA		

## GASOLINE



ENGINE TYPE Motortyp Type de Moteur Tipo de motor Тип двигателя	LINER KIT Liner Kit Kit de Chemise Camisas de los cilindros лайнер комплект	CYL. LINER Zylinderlaufbuchse Chemise Camisas de los cilindros втулка цилиндра	PISTON + RINGS Kolben + Ringe Piston + Segments Pistón Set Поршень и кольца			PISTON SET Kolben Set Set de Piston Pistón Set поршневой	RINGS SET Kolben Set Segments de Piston Anillos Set кольца	PIN Pin Axe Perno Пин
<b>100 G</b> <b>100 GL</b> 4 Cyl 65.0 mm Bore Ø 843 cc 903 cc		Length:		Length:	61.2	Top:	1.75	Ø: 20.0 Length: 54.0
		Outside Ø:		Comp:	30.7	2nd:	2.0	
		Flange Ø:		Height:	0	3rd:	3.94	
		flange depth				1st oil:		
			Reference no.:	Reference no.:	Reference no.:	Reference no.:	O-RING	
				A-24165 K-90451700 M-0072000 N-8720980000		A-R46550 G-0820980000 K-800005641000 M-00720N0		
NM-Germany Article no. Artikelnummer/ Modelo Número / статья НОМЕР	NM-Germany Article no.	NM-Germany Article no.	NM-Germany Article no.	NM-Germany Article no.	NM-Germany Article no.	NM-Germany Article no.	NM-Germany Article no.	NM-Germany Article no.
			KBSZA40925G	KBZA40925G	KRZA40925G			

ENGINE TYPE Motortyp Type de Moteur Tipo de motor Тип двигателя	LINER KIT Liner Kit Kit de Chemise Camisas de los cilindros лайнер комплект	CYL. LINER Zylinderlaufbuchse Chemise Camisas de los cilindros втулка цилиндра	PISTON + RINGS Kolben + Ringe Piston + Segments Pistón Set Поршень и кольца			PISTON SET Kolben Set Set de Piston Pistón Set поршневой	RINGS SET Kolben Set Segments de Piston Anillos Set кольца	PIN Pin Axe Perno Пин
<b>115 C</b> 4 Cyl 77.0 mm Bore Ø 1,481 cc	M-0075290 K-90395600 M-0075200 M-007WV70	Length:		Length:	89.0	Top:	2.0	Ø: 22.0 Length: 65.0
		Outside Ø:	133.0	Comp:	36.5	2nd:	2.0	
		Flange Ø:	81.0	Height:	9.5	3rd:	3.95	
		flange depth				1st oil:		
			Reference no.:	Reference no.:	Reference no.:	Reference no.:	O-RING	
NM-Germany Article no. Artikelnummer/ Modelo Número / статья НОМЕР	NM-Germany Article no.	NM-Germany Article no.	NM-Germany Article no.	NM-Germany Article no.	NM-Germany Article no.	NM-Germany Article no.	NM-Germany Article no.	NM-Germany Article no.
	LBSZA40926GP	LBZA40926GP	KBSZA40926G	KBZA40926G	KRZA40926G			

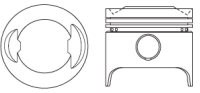

ZASTAVA

ENGINE TYPE Motortyp Type de Moteur Tipo de motor Тип двигателя	LINER KIT Liner Kit Kit de Chemise Camisas de los cilindros лайнер комплект	CYL. LINER Zylinderlaufbuchse Chemise Camisas de los cilindros втулка цилиндра	PISTON + RINGS Kolben + Ringe Piston + Segments Pistón Set Поршень и кольца			PISTON SET Kolben Set Set de Piston Pistón Set поршневой	RINGS SET Kolben Set Segments de Piston Anillos Set кольца	PIN Pin Axe Perno Пин
<b>132 AB 0A</b> 4 Cyl 80.0 mm Bore Ø 1,592 cc		Length:		Length:	81.8	Top:	1.5	Ø: 22.0 Length: 68.0
		Outside Ø:		Comp:	37.7	2nd:	2.0	
		Flange Ø:		Height:	4.6	3rd:	3.95	
		flange depth				1st oil:		
			Reference no.:	Reference no.:	Reference no.:	Reference no.:	O-RING	
				K-92472600 M-0075600		A-R47750 G-0820310000 K-800006141000 M-00765N0		
NM-Germany Article no. Artikelnummer/ Modelo Número / статья НОМЕР	NM-Germany Article no.	NM-Germany Article no.	NM-Germany Article no.	NM-Germany Article no.	NM-Germany Article no.	NM-Germany Article no.	NM-Germany Article no.	NM-Germany Article no.
			KBSZA40927G	KBZA40927G	KRZA40927G			

**GASOLINE**

ENGINE TYPE	LINER KIT	CYL. LINER	PISTON + RINGS		PISTON SET	RINGS SET	PIN
Motortyp Type de Moteur Tipo de motor Тип двигателя	Liner Kit Kit de Chemise Camisas de los cilindros лайнер комплект	Zylinderlaufbuchse Chemise Camisas de los cilindros втулка цилиндра	Kolben + Ringe Piston + Segments Pistón Set Поршень и кольца		Kolben Set Set de Piston Pistón Set поршень	Kolben Set Segments de Piston Anillos Set кольца	Pin Axe Perno Пин
<b>132 AB</b> <b>132 B</b> <b>132 BB</b> 4 Cyl 84.0 mm Bore Ø 1,756 cc		Length:	Length: 79.9			Top: 1.5 2nd: 2.0 3rd: 1st oil: 3.95 2nd oil:	Ø: 22.0 Length: 69.0
		Outside Ø: Flange Ø: flange depth	Comp: 38.4 Height: 2.0				
		Reference no.:	Reference no.: <b>K-92425600</b> <b>M-0077500</b>	Reference no.:	Reference no.: <b>A-R46970</b> <b>G-0821530010</b> <b>K-800006541000</b> <b>M-00865N0</b>	Reference no.:	O-RING
							
NM-Germany Article no. Artikelnummer/ Modelo Número / статья НОМЕР	NM-Germany Article no.	NM-Germany Article no.	NM-Germany Article no.	NM-Germany Article no.	NM-Germany Article no.	NM-Germany Article no.	NM-Germany Article no.
			KBSZA40928G	KBZA40928G	KRZA40928G		

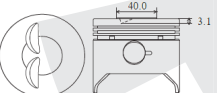
**GASOLINE**

ENGINE TYPE	LINER KIT	CYL. LINER	PISTON + RINGS		PISTON SET	RINGS SET	PIN
Motortyp Type de Moteur Tipo de motor Тип двигателя	Liner Kit Kit de Chemise Camisas de los cilindros лайнер комплект	Zylinderlaufbuchse Chemise Camisas de los cilindros втулка цилиндра	Kolben + Ringe Piston + Segments Pistón Set Поршень и кольца		Kolben Set Set de Piston Pistón Set поршень	Kolben Set Segments de Piston Anillos Set кольца	Pin Axe Perno Пин
<b>128 AS</b> 4 Cyl 86.0 mm Bore Ø 1,290 cc		Length:	Length: 77.3			Top: 1.5 2nd: 2.0 3rd: 1st oil: 3.95 2nd oil:	Ø: 22.0 Length: 69.0
		Outside Ø: Flange Ø: flange depth	Comp: 34.7 Height: 0.6 -3.1				
		Reference no.:	Reference no.: <b>K-93449600</b> <b>M-0078000</b>	Reference no.:	Reference no.: <b>M-00780N0</b>	Reference no.:	O-RING
							
NM-Germany Article no. Artikelnummer/ Modelo Número / статья НОМЕР	NM-Germany Article no.	NM-Germany Article no.	NM-Germany Article no.	NM-Germany Article no.	NM-Germany Article no.	NM-Germany Article no.	NM-Germany Article no.
			KBSZA40929G	KBZA40929G	KRZA40929G		

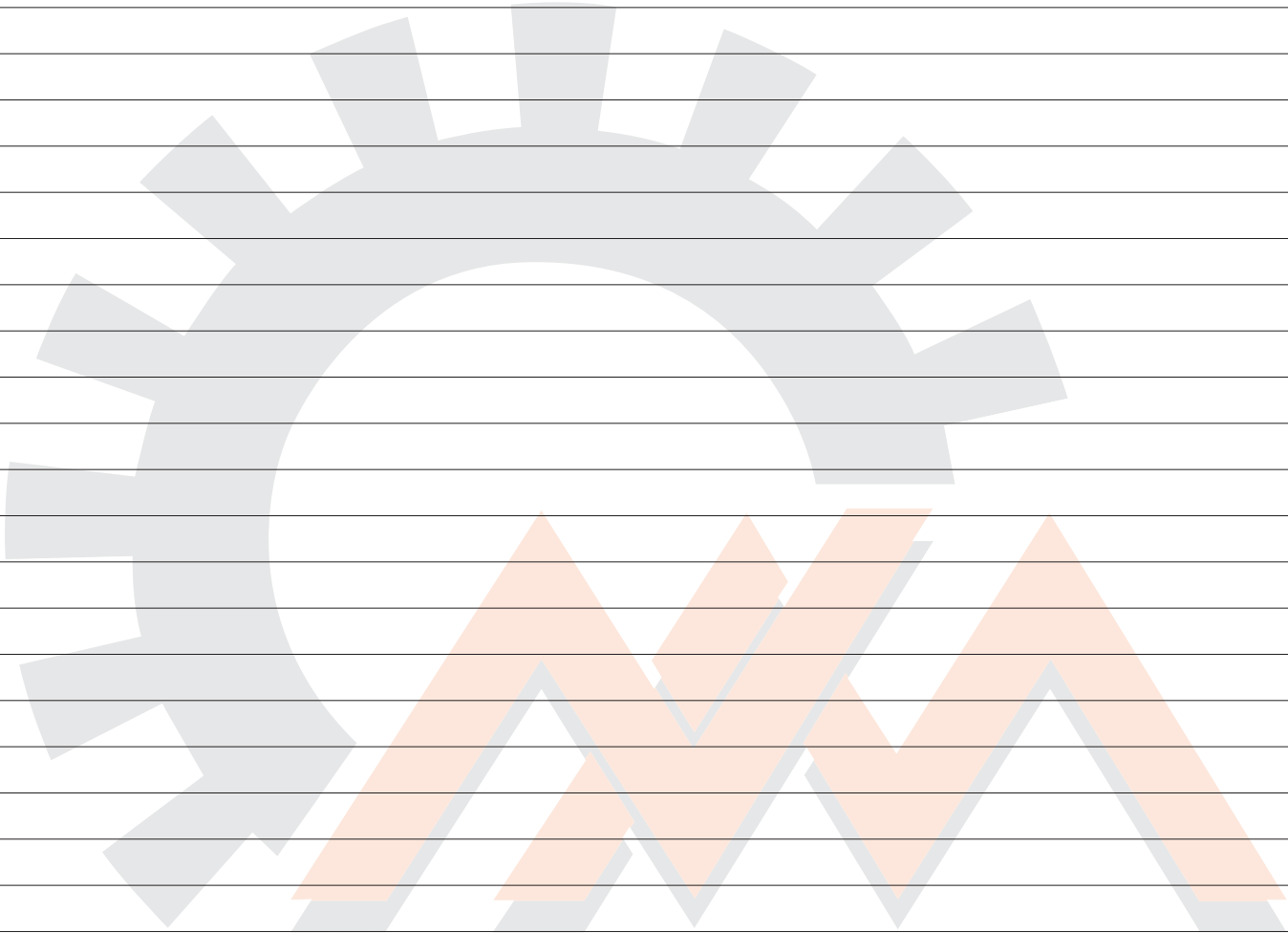



# PRODUCT CATALOGUES:

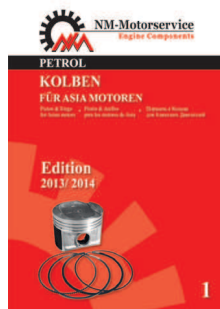

NR. 1

## PETROL KOLBEN FÜR ASIA MOTOREN

Piston & Rings for Asian motors • Pistón & Anillos para los motores de Asia • Поршень & Кольца для Азиатских Двигателей

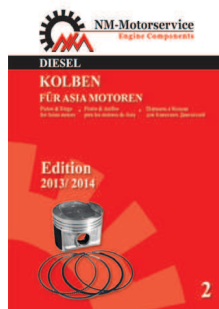

NR. 2

## DIESEL KOLBEN FÜR ASIA MOTOREN

Piston & Rings for Asian motors • Pistón & Anillos para los motores de Asia • Поршень & Кольца для Азиатских Двигателей



NR. 3

## LAGER

Engine bearings • Cojinetes • Вкладыши



NR. 4

## ZYLINDERKÖPFE

Cylinder Heads • Las cabezas de cilindro • Головки Цилиндров



NR. 5

## ÖLPUMPEN

Oil pumps • Bombas de aceite • Нефтяные Насосы



NR. 6

## STEUERKETTENSATZ

Timing Chains Kits • Juego de Cadena de distribución • Комплект цепи Привода



NR. 7

## KURBELWELLEN

Crankshafts • Cigüeñales • Коленчатых Валов



NR. 8

## NOCKENWELLEN

Camshafts • Árboles de levas • Распределительные Вали



NR. 9

## VENTILE

Engine valve • Válvula • Двигатель Клапана



NR. 10

## VENTILFÜHRUNGEN

Valve guide • Guía de la Válvula • Клапан Руководство



NR. 11

## VENTILSITZE

Valve Seat • Válvula de asiento • Седло Клапана



NR. 12

## KOLBEN FÜR LKW & INDUSTRIEMOTOREN

Piston & Rings for truck and industry engines • Pistón & Anillos para camiones y motores de la industria • поршень и кольца для грузовых автомобилей и двигателей промышленности

## PRODUCT CATALOGUES

To get yours please contact us at:

Tel: ++ 49 (0) 25 68 93 44 0  
Fax: ++ 49 (0) 25 68 93 44 11

Email: [info@nm-germany.com](mailto:info@nm-germany.com)  
Website: [www.nm-germany.com](http://www.nm-germany.com)

(Also available as PDF)





# NM-Germany



NM-Germany GmbH  
Siemensstrasse 20 48619  
Heek Germany  
Tel: +49 2568 9344-0  
Fax: +49 2568 9344-10

[info@nm-germany.com](mailto:info@nm-germany.com)  
[www.nm-germany.com](http://www.nm-germany.com)