

NM-Motorservice
Engine Components

DIESEL

KOLBEN

FÜR ASIA MOTOREN

Piston & Rings
for Asian motors

• Pistón & Anillos
para los motores de Asia

• Поршень и Кольца
для Азиатских Двигателей

Edition
2013/ 2014



PISTON TERMINOLOGY

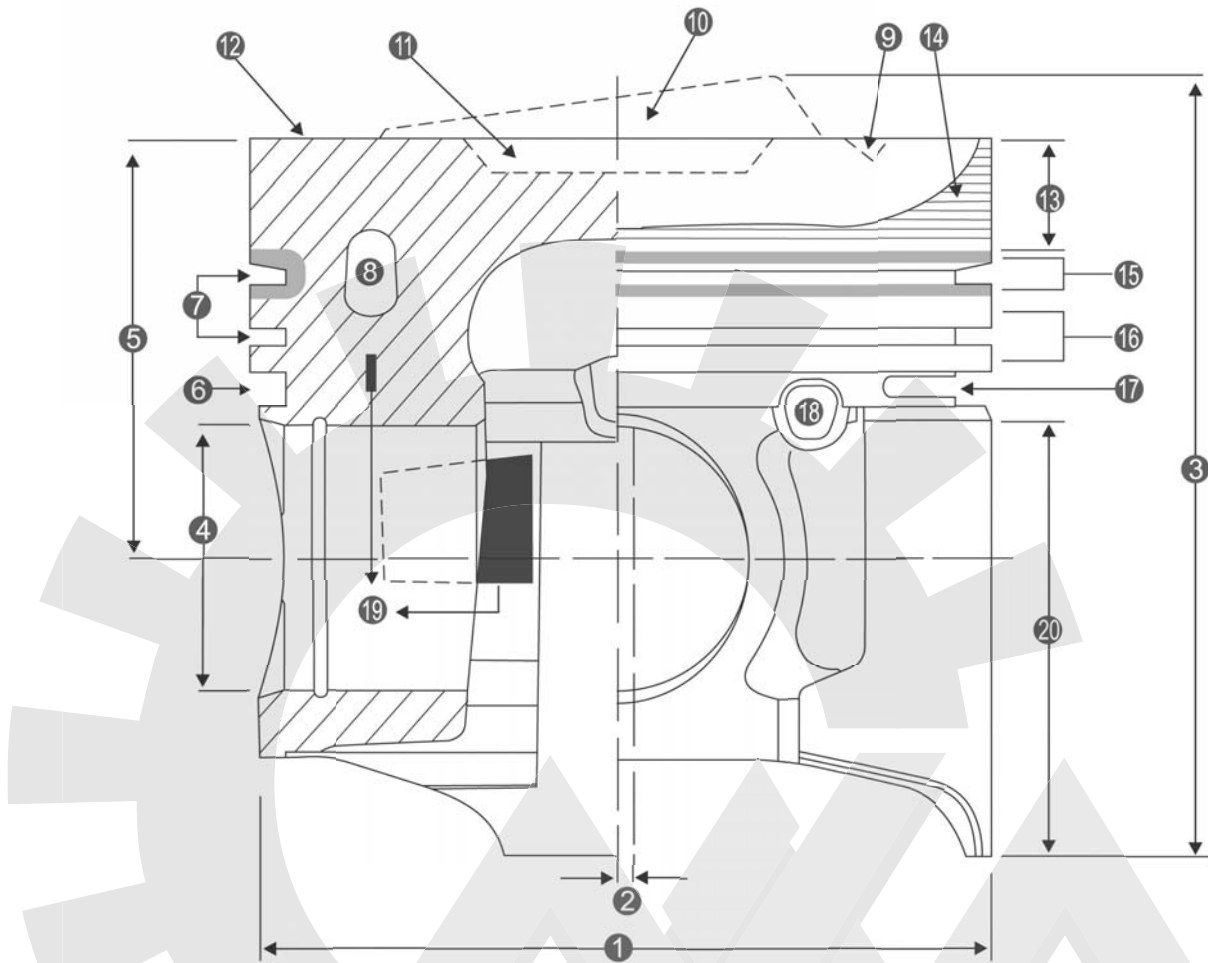

- | | |
|-------------------------------------------|---------------------------|
| ① Piston skirt diameter | ⑪ Combustion-chamber bowl |
| ② Piston offset | ⑫ Piston crown |
| ③ Total piston length | ⑬ Top land |
| ④ Piston pin hole diameter | ⑭ Anti-scuff bands |
| ⑤ Compression height | ⑮ Alfin (Ring carrier) |
| ⑥ Oil ring groove | ⑯ Ring land |
| ⑦ Top and second compression ring grooves | ⑰ Oil slit groove |
| ⑧ Oil gallery (Oil cooling channel) | ⑱ Oil return hole |
| ⑨ Valve recess depth | ⑲ Hidden steel struts |
| ⑩ Crown chamber | ⑳ Skirt area |

LINER / SLEEVE TERMINOLOGY

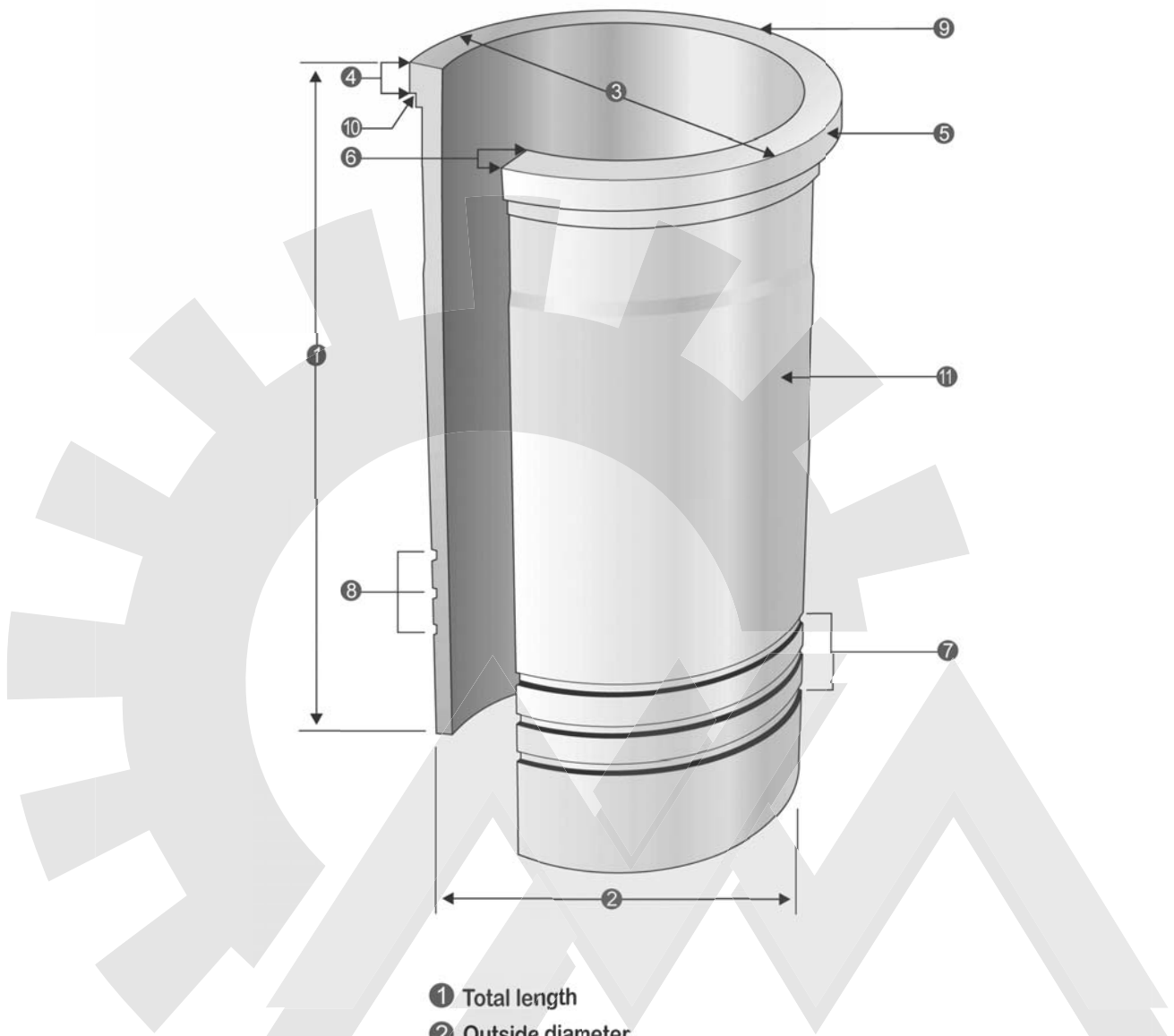

- ① Total length
- ② Outside diameter
- ③ Flange diameter (Register diameter)
- ④ Flange depth (Collar height)
- ⑤ Flange
- ⑥ Top land width
- ⑦ Sealing area
- ⑧ O-Ring groove
- ⑨ Firewall
- ⑩ Machining relief
- ⑪ Barrel

PISTON RINGS TERMINOLOGY

COMPRESSION RING

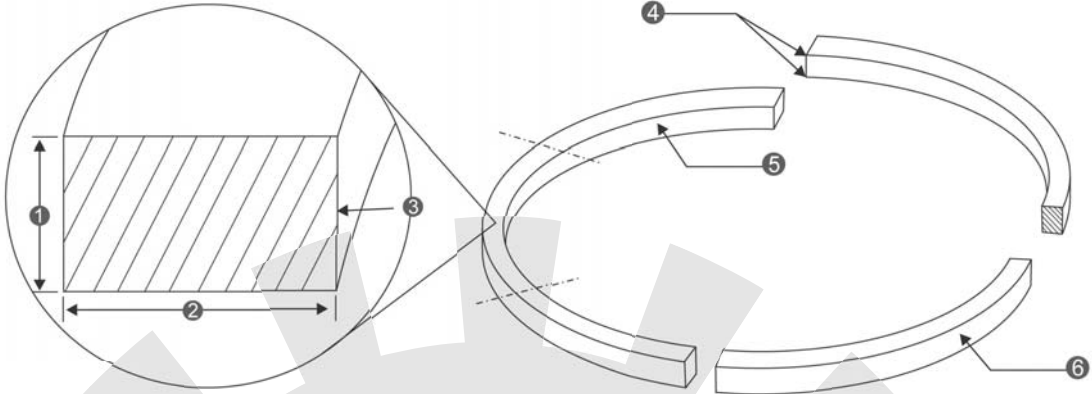

OIL CONTROL RING

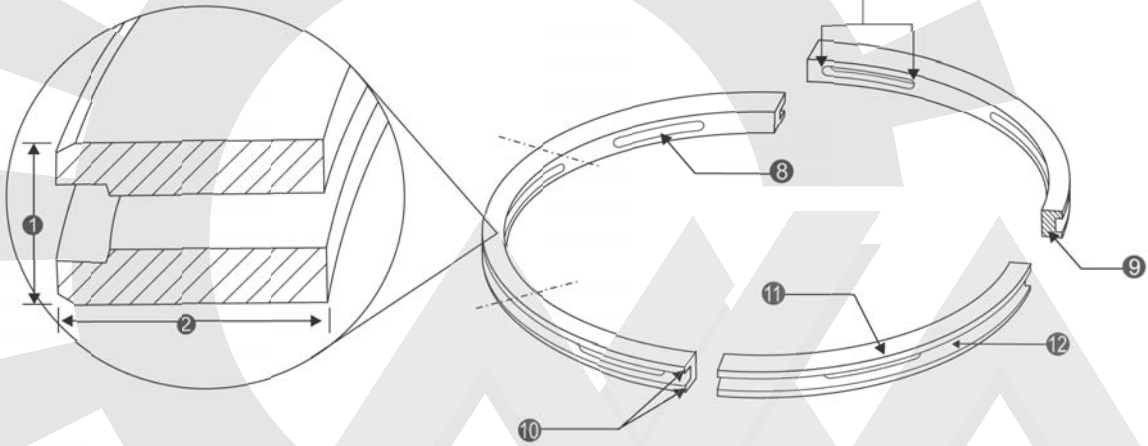

- ① Piston ring width
- ② Piston ring thickness
- ③ Inside edge of gap
- ④ Inside edges
- ⑤ Inside surface
- ⑥ Peripheral surface
- ⑦ Inside edges of slot
- ⑧ Slot face
- ⑨ Gap face
- ⑩ Outside gap corners
- ⑪ Side face
- ⑫ Outside groove face

LBS = LINER KIT
 Liner Kit/
 camisas de los cilindros/
 Лайнер комплект
LBS = LB + KBS

LB = CYL. LINER
 Zylinderlaufbuchse/
 camisas de los cilindros/
 втулка цилиндра

KBS = PISTON + RINGS
 Kolben + Ringe/
 Pistón + Anillos/
 поршень и кольца

KB = PISTON SET
 Kolben Set/
 Pistón Set/
 поршневой

KR = RINGS SET
 Ring Set/
 Anillos Set/
 кольца

PB = PIN
 Pin/
 Perno/
 Пин

Description of Engine and Liner/ Sleeve:

C = Chromed liner
F = Fully-finished liner
P = Semi-finished sleeve, w/ out flange
S = Semi-finished sleeve

Description of Piston:

A = Alfin
B = Alfin and with oil gallery
G = Oil gallery

Größen/ Sizes/ Tamaños/ Размеры:

Standard/ Standard/ Estándar/ Стандарт:	0,00 mm
Übergröße/ Oversize/ Grande/ Негабаритный:	
S1	0,25 mm
S2	0,50 mm
S3	0,75 mm
S4	1,00 mm



THIS IS A PARTS REFERENCE CATALOGUE ONLY. WHILST EVERY ENDEAVOR HAS BEEN MADE TO ENSURE THE ACCURACY OF THE INFORMATION, NO LIABILITY WILL BE ACCEPTED FOR ANY ERRORS OR OMISSIONS. ACCORDINGLY, CLAIMS ORIGINATING FROM INFORMATION CONTAINED IN THIS CATALOGUE CANNOT BE RECOGNIZED.

WE WOULD BE PLEASED TO RECEIVE ANY ADVICE ON ANY ERRORS OR ADDITIONS WHICH MAY COME TO YOUR ATTENTION.

SINCERELY,
YOURS  **NM-Motorservice**
 Engine Components **TEAM**

PRODUCT CATALOGUES:

Edition
2013/2014

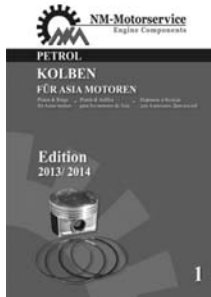

NR. 1

PETROL KOLBEN FÜR ASIA MOTOREN

Piston & Rings for Asian motors • Pistón & Anillos para los motores de Asia • Поршень & Кольца для Азиатских Двигателей



NR. 2

DIESEL KOLBEN FÜR ASIA MOTOREN

Piston & Rings for Asian motors • Pistón & Anillos para los motores de Asia • Поршень & Кольца для Азиатских Двигателей



NR. 3

LAGER

Engine bearings • Cojinetes • Вкладыши



NR. 4

ZYLINDERKÖPFE

Cylinder Heads • Las cabezas de cilindro • Головки Цилиндров



NR. 5

ÖLPUMPEN

Oil pumps • Bombas de aceite • Нефтяные Насосы



NR. 6

STEUERKETTENSATZ

Timing Chains Kits • Juego de Cadena de distribución • Комплект цепи Привода



NR. 7

KURBELWELLEN

Crankshafts • Cigüeñales • Коленчатых Валов



NR. 8

NOCKENWELLEN

Camshafts • Árboles de levas • Распределительные Валы



NR. 9

VENTILE

Engine valve • Válvula • Двигатель Клапана



NR. 10

VENTILFÜHRUNGEN

Valve guide • Guía de la Válvula • Клапан Руководство



NR. 11

VENTILSITZE

Valve Seat • Válvula de asiento • Седло Клапана



NR. 12

KOLBEN FÜR LKW & INDUSTRIEMOTOREN

Piston & Rings for truck and industry engines • Pistón & Anillos para camiones y motores de la industria • поршень и кольца для грузовых автомобилей и двигателей промышленности





Modell Model/ Modelo/ Модель	Seite Page/ Página/ Страница	Modell Model/ Modelo/ Модель	Seite Page/ Página/ Страница
PISTON TERMINOLOGY.....	1	EC100 KL.....	25
GUIDE to NM-Motorservice numbers.....	4	W06D.....	25
INDEX.....	7	W06E.....	25
		W06D New.....	26
ASIA.....	18	W06DT.....	26
SS K2700.....	18	EH100 KR.....	26
		DS70.....	27
DAEWOO.....	18	H06BT.....	27
DB33.....	18	EH300.....	27
		H06C.....	28
DAIHATSU.....	19-21	H06CT.....	28
CL.....	19	H06CT.....	28
CLT.....	19	H06CT.....	29
DG 5 Rings.....	19	H06CT TA.....	29
DG 4 Rings.....	20	EH700.....	29
DG 3 Rings.....	20	H07C.....	30
DL.....	20	H07D.....	30
DL.....	21	H07C New.....	30
DL.....	21	EH700 New.....	31
		EH700T.....	31
HINO.....	22-41	EH700T New.....	31
W04D.....	22	H07CT.....	32
W04D New.....	22	H07DT.....	32
W04CT.....	22	DS50/ DS80.....	32
W04DT.....	23	H07CT New.....	33
J05C.....	23	H07CA New.....	33
J05CT.....	23	J08C.....	33
J07C.....	24	J08CT.....	34
J07CT.....	24	J08C.....	34
DM100 KM.....	24	EL100.....	34
		EL100.....	35
		EB300.....	35
		EP100T.....	35
		EP100/ P09C.....	36
		EM100.....	36
		M10C.....	36
		M10U.....	37

INDEX

Modell Model/ Modelo/ Модель	Seite Page/ Página/ Страница	Modell Model/ Modelo/ Модель	Seite Page/ Página/ Страница
ED100.....	37	D4CB CRDi	47
K13C.....	37	D4BA	47
EK100/ EK200	38	D4BB	48
K13D.....	38	D4BF	48
K13D.....	38	D4BX	48
EK130T.....	39	D4BX New	49
EF100 (L/R)	39	D4BH (L/R).....	49
EF550 (L/R)	39	D4BH TCi (L/R)	49
EF550.....	40	D4BH (L/R).....	50
EF500 (L/R)	40	J3 TCi.....	50
EF750 (L/R)	40	J3 CRDi New	50
F17C (L/R)	41	D4AE	51
F17E (L/R)	41	D4AL.....	51
F20C (L/R)	41	D4AF	51
		D4DA	51
		D4AF New	52
		D6BR	52
HONDA	42-43		
CONCERTO 1.8 TD	42	ISUZU.....	53-92
20T2N TURBO	42	3KR1.....	53
20T2R TURBO	42	4EC1.....	53
N22A1/ N22A2	43	4EC1T	53
		4FE1.....	54
HYUNDAI.....	44-52	4EE1T.....	54
D3FA.....	44	4EE1.....	54
D3EA	44	4EE1T New	55
D4FA.....	44	4EE1 New.....	55
D4FC CRDi.....	45	4EE1T New	55
D4FB	45	4EE2 CDTi	56
D4EA	45	4EE2.....	56
D4EA New	46	C221.....	56
DJY.....	46	4FB1.....	57
XUD 9A.....	46	4FC1.....	57
D4EA	46	C240 4 Rings Early.....	57
D4EB-F.....	47	C240 4 Rings	58
D4EB-G	47		

Modell Model/ Modelo/ Модель	Seite Page/ Página/ Страница	Modell Model/ Modelo/ Модель	Seite Page/ Página/ Страница
C190 4 Rings	58	4BD1T	71
C240 3 Rings	58	4BD1T	71
C190 3 Rings	59	4BD2T	71
C240 3 Rings New	59	4BD2T New	72
C223 Early	59	4BE1	72
C223 New	60	4BE1	72
C223T	60	4HE1T	73
4FD1	60	4HE1-TC	73
C223T	61	4HF1	73
C223T New	61	4HF1	74
4JC1	61	4HF1 New	74
C 2.2	62	4HG1	74
4FG1	62	4HG1	75
4JA1	62	4HG1/ 4HG1T	75
4JA1 New	63	4HK1-TC	75
4JB1	63	4HK1-TC	76
4JB1T	63	4HJ1	76
4JB1T New	64	4HL1	76
4JB1 New	64	4HK1-TC	77
4JA1T New	64	6DE1 (L/R)	77
4JG2	65	DA120 4 Rings	77
4JG2T	65	DA640 4 Rings	78
4JX1	65	6BB1	78
4JH1-TC	66	6BD1	78
4JG2T New	66	6BD1T	79
4JH1-TC New	66	6BD1T	79
4JJ1-TC CRDi	67	6BG1	79
4JK1-TC	67	6BG1T	80
4JG2T	67	6BF1	80
4JG1	68	6BG1T	80
4BA1	68	6BG1	81
DA220 4 Rings	68	6HE1	81
4BC1	69	6HE1T	81
4BC2	69	6HE1T New	82
4BB1	70	6HE1-TC	82
4BD1	70	6HE1T	82
4BD1 New	70	6HH1	83

INDEX

Modell Model/ Modelo/ Модель	Seite Page/ Página/ Страница	Modell Model/ Modelo/ Модель	Seite Page/ Página/ Страница
6SA1.....	83	RIO 1.5 CRDi.....	93
6SA1T.....	83	CEE'D 1.6 TCi.....	93
6HH1.....	84	CERATO 1.6 TDi.....	93
6HH1T.....	84	CARENS CRDi.....	94
6HK1-TC.....	84	NEW SPORTAGE TCi.....	94
6HK1-TC.....	84	NB-1 B2200.....	94
6HK1-TC.....	85	HW.....	94
6HL1-TC.....	85	NB-7.....	95
DH100.....	85	RF-TCi.....	95
6SD1.....	86	K2500 (L/R).....	95
6SD1T New.....	86	K2500 TCi (L/R).....	95
6SD1.....	86	K2500 (L/R).....	96
6SD1T.....	86	SF K2400.....	96
6SD1T.....	87	RFA.....	96
6SD1TC.....	87	CN.....	96
6QA1.....	87	J2.....	97
6QA1.....	88	JS K2700.....	97
6WA1-TC.....	88	J3 TCi.....	97
E120.....	88	JT.....	97
E120.....	89	JD K3500.....	98
E120T.....	89	SH K3600.....	98
6RA1.....	89	SH K3600 New.....	98
6RB1.....	90		
6RB1T.....	90		
6RA1T.....	90		
PA1.....	91		
PB1.....	91		
PC1.....	91		
PC1T TURBO.....	92		
PD1.....	92		
PE1.....	92		
		KOMATSU..... 99-111	
		4D94.....	99
		4D94.....	99
		4D94E.....	99
		4D94.....	100
		4D95.....	100
		S4D95/ S6D95.....	100
		4D95S.....	101
		6D95.....	101
		S6D95L.....	101
		4D95L.....	102
		4D95.....	102
KIA..... 93-98			
PICANTO 1.1 TDi.....	93		
CERATO 1.5 TDi.....	93		

Modell Model/ Modelo/ Модель	Seite Page/ Página/ Страница	Modell Model/ Modelo/ Модель	Seite Page/ Página/ Страница
6D95A.....	102	Y4 CDi	112
S6D102.....	103	UA.....	113
S4D102.....	103	Y6 CDi	113
S6D102.....	103	PN.....	113
4D105.....	103	323 1.7 TD	114
6D105.....	103	VA.....	114
4D105-3C.....	104	RTE/ RTF	114
6D105.....	104	R2.....	115
4D105.....	104	R2.....	115
6D105.....	104	RF.....	115
SA6D105	105	RF New.....	116
S4D105.....	105	R2 New.....	116
SA6D105	105	RF2.....	116
4D105.....	106	RF7.....	117
SA6D108	106	RF8.....	117
S6D108.....	106	XA E2500	117
S6D110.....	107	S2 E2200	118
SA6D110	107	XA E2500	118
6D110.....	107	XA T2500	118
S6D110.....	108	S5 E2500	118
4D120.....	108	XB E2700	119
6D125.....	108	WL	119
S6D125.....	109	WLT	119
S6D125.....	109	WL-C	120
S6D125.....	109	JS K2700	120
S6D125.....	110	HA E3000	120
4D130.....	110	HA T3000	121
SA6D155	110	W9	121
S6D155.....	111	WE	121
SV6D170	111	SL T3500	122
S6D170.....	111	SL T3500	122
		SLT T3500T	122
		SLT T3500T	123
		SL T3500	123
		TF T4000	123
		TM	124
		ZB E4100 5 Rings	124
MAZDA.....	112-124		
PB.....	112		
TB.....	112		

INDEX

Modell
Model/ Modelo/ Модель

Seite
Page/ Página/ Страница

ZB T4100 3 Rings. 124

MITSUBISHI. 125-167

K3E/ K4E 125
 NM75 125
 NM90 125
 F8Q 784 TURBO 126
 4D65. 126
 4D65T. 126
 4D65T. 127
 4D68. 127
 4D68T. 127
 COLT 1.5 DI-D 128
 4N13. 128
 4DQ5 128
 4N14. 129
 4D56. 129
 4D55. 129
 4D56. 129
 4D56 New. 130
 4D55T / 4D56T 130
 4D55T (L/R) 130
 4D56T (L/R) 130
 4D56T. 131
 4D56T New (L/R) 131
 4D57. 131
 4D56T (L/R) 132
 4D56T CRDi (L/R) 132
 4D55T (L/R) 132
 4D56T (L/R) 132
 4DR5 133
 4DR5 New 133
 4DR5 133
 4DR51 133
 S4E. 134

Modell
Model/ Modelo/ Модель

Seite
Page/ Página/ Страница

S4E1. 134
 S4S. 134
 4DR7 135
 4M40. 135
 4M40T 135
 4M40 New 136
 4M42-0AT. 136
 4M40. 136
 4M42. 137
 S4E2. 137
 S4F. 137
 S4E2. 138
 4M41. 138
 4M41T 138
 4M41. 138
 4M41T 138
 4D30. 139
 4D31. 139
 4D31T. 139
 4D31T New. 140
 4D31T New. 140
 4D31. 140
 4D32. 141
 4D34. 141
 4D34T. 141
 4D32 Late. 142
 4D32 New. 142
 4D34T New. 142
 4D36. 143
 4D34T. 143
 4D34 • 2AT 143
 4D34 • 3AT 143
 4D33. 144
 4D33. 144
 4D33 • 4A. 144
 4D35. 144
 4D35T. 144

Modell Model/ Modelo/ Модель	Seite Page/ Página/ Страница	Modell Model/ Modelo/ Модель	Seite Page/ Página/ Страница
4M50T	145	6D15T • 3AT	156
4M51	145	6D16	156
4D35	145	6D16	156
4D35T	145	6D16T	157
4M51	146	6D17	157
4M51T	146	6D20	157
6DR5	146	6D20	158
S6E	147	6D22	158
S6S	147	6D22	158
6DR5	147	6D22T	159
6DR51	147	6D22T	159
6DS7	148	6D22 • 3AT	159
6DS7 New	148	6D24	160
S6E2	148	6D24 • 3V	160
S6F	149	6D24	160
6D31T	149	6D24 • 3V	161
6D31	149	8DC4	161
S6KT	150	8DC2	161
6D34T	150	8DC8	162
6D34 • 2AT	150	8DC81	162
6D34 • 3AT	150	8DC82	162
6D10	151	8DC9	163
6D11	151	8DC9T	163
6D14	151	8DC91	163
6D14 • A	152	8DC91T	164
6D14 • 2A	152	8DC9 • 3A	164
6D14T	152	8DC6	164
6D14T	153	8DC9 • 3AT	165
6D14 • 3AT	153	8DC91 • 3AT	165
6D14 • 2A	153	8DC82	165
6D14 • 3A	153	8DC9T2	166
6DB1	154	8DC9T2 • 3V	166
6D14 • A	154	8DC10	166
6D15	154	8DC10	167
6D15	155	8DC11	167
6D15T	155	8M20	167
6D15T New	155		

Modell **Seite**
 Model/ Modelo/ Модель Page/ Página/ Страница

Modell **Seite**
 Model/ Modelo/ Модель Page/ Página/ Страница

NISSAN 168-204

K9K 700/704.....	168
K9K 722/750.....	168
K9K 700/704.....	168
K9K 722/750.....	168
TD15.....	168
CD17.....	169
F9Q 780.....	169
F9Q 800.....	169
R9M.....	170
SD22 5 Rings.....	170
SD22 3 Rings.....	170
M9R 780.....	171
M9R 780.....	171
M1D.....	171
CD20.....	172
CD20T.....	172
LD20.....	172
LD20 II.....	173
LD20 New.....	173
LD20T.....	173
M9T.....	173
YD22DDT/ DDTi.....	174
YD22ETi/ TDi.....	174
YD22DDT/ DDTi.....	174
YD22DDT / ETi.....	174
YD22 ETi.....	175
LD23.....	175
G9T 722.....	175
SD23/ SD25.....	176
SD23 New.....	176
SD25 New.....	176
TD23.....	176
YD25DDTi.....	177
YD25DDTi.....	177

G9U 720.....	177
G9U 720/724.....	178
G9U 730/750/754.....	178
G9U 630/632/635.....	178
YD25DDTi.....	178
TD25.....	179
BD25.....	179
TD25 New.....	179
TD25Ti.....	180
TD27.....	180
TD27 New.....	180
TD27T.....	181
BD30.....	181
TD27T.....	181
TD27Ti New.....	182
BD30T.....	182
ZD30.....	182
ZD30DDTi.....	182
ZD30.....	183
ZD30DDTi.....	183
ZD30DDTi.....	183
TD27T New.....	183
TD27Ti.....	184
ZD30DD.....	184
BD30Ti.....	184
ED30 4 Rings.....	185
ED30 3 Rings.....	185
QD32.....	185
QD32Ti.....	186
ED33.....	186
ED33 New.....	186
FD33.....	187
FD33T.....	187
ED35.....	187
FD35T.....	188
FD35.....	188
FD46.....	188



Modell Model/ Modelo/ Модель	Seite Page/ Página/ Страница	Modell Model/ Modelo/ Модель	Seite Page/ Página/ Страница
FD42.....	189	PD6.....	200
FD46 FD46T.....	189	PD6T	201
SD33(T) 5 Rings.....	189	PE6.....	201
SD33(T) 3 Rings.....	190	PE6T.....	201
SD33T 5 Rings	190	PE6TB	202
V9X.....	190	PF6TB	202
LD28.....	191	GE13T	202
RD28	191	RD8	203
RD28T	191	RD10	203
RD28Ti New	192	RD8T	203
TD42.....	192	RD10T	203
TD42 New.....	192	RE8.....	203
TD42T.....	193	RE10.....	203
TD42T.....	193	RF8 (L/R).....	204
TD42T II.....	193		
TD42T New	193	SAMSUNG..... 205	
TD42T.....	194	MD30	205
TD42Ti	194		
ED6.....	194	SSANGYONG206-208	
FD6T 4 Rings	194	D20DT	206
FD6T 3 Rings	195	DC 23.....	206
FD6T 3 Rings	195	D27DT	206
FD6 4 Rings	195	OM602 TURBO	207
FD6 3 Rings	196	OM662 TURBO	207
FD6 3 Rings	196	OM661	207
FE6.....	196	OM662	207
FE6T.....	197	OM661	207
FE6TA.....	197	OM662	207
FE6T.....	197	XD 3P.....	208
FE6T New.....	198	XD 3T.....	208
FE6B 24V.....	198		
FE6T.....	198	SUZUKI209-211	
FE6T.....	199		
ND6	199		
NE6.....	199		
NE6T	200		
NF6T.....	200		

INDEX

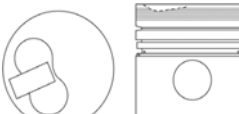

Modell Model/ Modelo/ Модель	Seite Page/ Página/ Страница	Modell Model/ Modelo/ Модель	Seite Page/ Página/ Страница
Z 13 DT.....	209	2J 3 Rings (L/R).....	220
K9K 700/766.....	209	2J 4 Rings (L/R).....	220
K9K 700/766.....	209	J 5 Rings (L/R).....	221
D19AA.....	210	2J 5 Rings (L/R).....	221
XUD 9A.....	210	L LN30.....	221
XUD 9SE.....	210	L LN40.....	221
RHZ.....	211	L LN50.....	222
		2L.....	222
		2LT.....	222
		2L II / 2L New.....	223
		2LT / 2LIIT.....	223
		2LT New.....	223
		2LIIT New.....	223
		2LT New.....	224
		2LIIT New.....	224
		2KD-FTV.....	224
		B 4 Rings.....	224
		B 3 Rings.....	225
		B(3) New.....	225
		11B.....	225
		11B.....	226
		3L.....	226
		1Z.....	226
		1KZ-TE.....	227
		1KZ-TE New.....	227
		1KD-FTV.....	227
		1KD-FTV New.....	228
		1KD-FTV.....	228
		1KD-FTV.....	228
		1KD-FTV.....	229
		2B.....	229
		2Z.....	229
		2Z New.....	230
		5L / 5L-E.....	230
		3B.....	230
		3B New.....	231
		13B.....	231
TOYOTA.....212-241			
1ND-TV.....	212		
1ND-TV.....	212		
2WZ-TV.....	212		
1N.....	213		
1WZ.....	213		
1CD-FTV.....	213		
1CD-FTV.....	214		
1C.....	214		
1C.....	214		
1C.....	215		
1C-TL.....	215		
1C New.....	215		
2C.....	216		
2C New.....	216		
2CT.....	216		
2CT-L.....	216		
2C.....	217		
2C.....	217		
2CT.....	217		
3C-TE.....	218		
3CT.....	218		
2AD-FTV.....	218		
1DZ.....	219		
1DZ New.....	219		
2AD-FHV.....	219		
1AD-FTV.....	220		

Modell Model/ Modelo/ Модель	Seite Page/ Página/ Страница	Modell Model/ Modelo/ Модель	Seite Page/ Página/ Страница
13BT.....	231		
14B.....	232		
14BT.....	232		
1W.....	232		
W04D.....	233		
N04C.....	233		
15B-FT.....	233		
15B-FT.....	234		
15B-FTE.....	234		
S05C.....	234		
S05D.....	235		
1PZ.....	235		
H 3 Rings (L/R).....	235		
2H.....	236		
2H New.....	236		
12HT.....	236		
1HZ New.....	237		
1HZ.....	237		
1HD-T.....	237		
1HD-T.....	238		
1HD-T.....	238		
1HD-FT.....	238		
1HZ.....	239		
1HD-FTE.....	239		
11Z.....	239		
12Z.....	240		
13Z.....	240		
2D 5 Rings.....	240		
2D 4 Rings.....	241		
1VD-FTV (L/R).....	241		



NOTES.....242-244

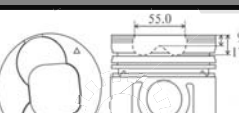

ENGINE TYPE Motortyp/ tipo de motor/ тип двигателя	LINER KIT Liner Kit/ camisas de los cilindros/ Лайнер комплект	CYL. LINER Zylinderlaufbuchse/ camisas de los cilindros/ втулка цилиндра		PISTON + RINGS Kolben + Ringe/ Pistón + Anillos/ поршень и кольца		PISTON SET Kolben Set/ Pistón Set/ поршневой	RINGS SET Ring Set/ Anillos Set/ кольца	PIN Pin/ Perno/ Пин	
SS K2700 ASIA TOPIC 2,700 cc 4 cyl 92.0 mm Bore Ø		Liner/ Sleeve		Piston			Rings		
		Length: Outside Ø: Flange Ø: Flange depth:	192.0 96.9 100.95 3.84 +0.7		Length: Comp. height:		103.4 60.4 -2.4 -5.4	Top: 2nd: oil:	
		Reference no.:		Reference no.:		Reference no.:		Reference no.:	
		K800-10-311A				K4Z0-11-SAO K480-11-102		K4Z0-11-SCO K480-23-206	
NM-Motorservice Article no./ Artikelnummer/ Modelo número/ статья номер	NM-Motorservice Article no.:	NM-Motorservice Article no.:		NM-Motorservice Article no.:		NM-Motorservice Article no.:	NM-Motorservice Article no.:	NM-Motorservice Article no.:	
	LBS 39350 FA LBS 39350 SA	LB 39350 F LB 39350 S		KBS 39350		KB 39350	KR 39350	PB 39350	

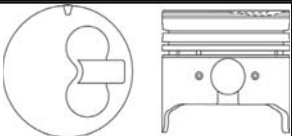

DAEWOO

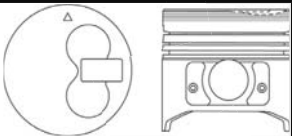

ENGINE TYPE Motortyp/ tipo de motor/ тип двигателя	LINER KIT Liner Kit/ camisas de los cilindros/ Лайнер комплект	CYL. LINER Zylinderlaufbuchse/ camisas de los cilindros/ втулка цилиндра		PISTON + RINGS Kolben + Ringe/ Pistón + Anillos/ поршень и кольца		PISTON SET Kolben Set/ Pistón Set/ поршневой	RINGS SET Ring Set/ Anillos Set/ кольца	PIN Pin/ Perno/ Пин	
DB33 3,268 cc 4 cyl 102.0 mm Bore Ø		Liner/ Sleeve		Piston			Rings		
		Length: Outside Ø: Flange Ø: Flange depth:	187.0 106.0 112.0 4.0		Length: Comp. height:		98.1 58.9 -9.1 -17.7	Top: 2nd: oil:	
		Reference no.:		Reference no.:		Reference no.:		Reference no.:	
						O-Ring:			
NM-Motorservice Article no./ Artikelnummer/ Modelo número/ статья номер	NM-Motorservice Article no.:	NM-Motorservice Article no.:		NM-Motorservice Article no.:		NM-Motorservice Article no.:	NM-Motorservice Article no.:	NM-Motorservice Article no.:	
	LBS 39400 F LBS 39400 S LBS 39400 FA LBS 39400 SA	LB 39400 F LB 39400 S		KBS 39400 KBS 39400 A		KB 39400 KB 39400 A	KR 39400	PB 39400	



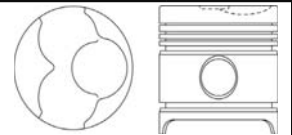

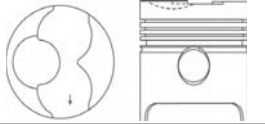

ENGINE TYPE Motortyp/ tipo de motor/ тип двигателя	LINER KIT Liner Kit/ camisas de los cilindros/ Лайнер комплект	CYL. LINER Zylinderlaufbuchse/ camisas de los cilindros/ втулка цилиндра			PISTON + RINGS Kolben + Ringe/ Pistón + Anillos/ поршень и кольца		PISTON SET Kolben Set/ Pistón Set/ поршневой	RINGS SET Ring Set/ Anillos Set/ кольца		PIN Pin/ Perno/ Пин
CL CHARADE G101 (1990.11-1993.01) 993 cc 3 cyl 76.0 mm Bore Ø			Flanged	No flange	Piston			Rings		Ø : 21.0 Length: 63.5
		Length: 140.0 Outside Ø: 80.0 Flange Ø: 83.0 Flange depth: 4.8		140.0 80.0	Length: 70.5 Comp. height: 38.5 -1.1	Top: 2.2 2nd: 1.5 oil: 3.0				
		Reference no.:					Reference no.:	Reference no.:		Reference no.:
		11461-87703					13101-87725 13101-87727 13102-87712	13011-87717 13011-87723A		
NM-Motorservice Article no./ Artikelnummer/ Modelo número/ статья номер	NM-Motorservice Article no.:	NM-Motorservice Article no.:			NM-Motorservice Article no.:		NM-Motorservice Article no.:	NM-Motorservice Article no.:		NM-Motorservice Article no.:
	LBS 10150 PA LBS 10150 SA	LB 10150 P LB 10150 S			KBS 10150 A		KB 10150 A	KR 10150		



ENGINE TYPE Motortyp/ tipo de motor/ тип двигателя	LINER KIT Liner Kit/ camisas de los cilindros/ Лайнер комплект	CYL. LINER Zylinderlaufbuchse/ camisas de los cilindros/ втулка цилиндра			PISTON + RINGS Kolben + Ringe/ Pistón + Anillos/ поршень и кольца		PISTON SET Kolben Set/ Pistón Set/ поршневой	RINGS SET Ring Set/ Anillos Set/ кольца		PIN Pin/ Perno/ Пин
CLT CHARADE G101 (1990.11-1993.01) 993 cc 3 cyl 76.0 mm Bore Ø			Flanged	No flange	Piston			Rings		Ø : 23.0 Length: 64.5
		Length: 140.0 Outside Ø: 80.0 Flange Ø: 83.0 Flange depth: 4.8		140.0 80.0	Length: 70.5 Comp. height: 40.5 -1.5	Top: 2.0 2nd: 1.5 oil: 3.0				
		Reference no.:					Reference no.:	Reference no.:		Reference no.:
		11461-87703					13101-87720 13102-87711	13011-87717 13011-87723A		
NM-Motorservice Article no./ Artikelnummer/ Modelo número/ статья номер	NM-Motorservice Article no.:	NM-Motorservice Article no.:			NM-Motorservice Article no.:		NM-Motorservice Article no.:	NM-Motorservice Article no.:		NM-Motorservice Article no.:
	LBS 10200 PA LBS 10200 SA	LB 10200 P LB 10200 S			KBS 10200 A		KB 10200 A	KR 10200		



ENGINE TYPE Motortyp/ tipo de motor/ тип двигателя	LINER KIT Liner Kit/ camisas de los cilindros/ Лайнер комплект	CYL. LINER Zylinderlaufbuchse/ camisas de los cilindros/ втулка цилиндра			PISTON + RINGS Kolben + Ringe/ Pistón + Anillos/ поршень и кольца		PISTON SET Kolben Set/ Pistón Set/ поршневой	RINGS SET Ring Set/ Anillos Set/ кольца		PIN Pin/ Perno/ Пин
DG 5 Rings 2,530 cc 4 cyl 88.0 mm Bore Ø			Flanged	No flange	Piston			Rings		Ø : 26.0 Length: 70.0
		Length: 182.0 Outside Ø: 93.0 Flange Ø: 97.0 Flange depth: 7.0 + 1.0			Length: 90.8 Comp. height: 50.5 -2.0 -6.0	Top: 2.0 2nd: 2.0 3rd: 2.0 1st oil: 4.0 2nd oil: 4.0				
		Reference no.:					Reference no.:	Reference no.:		Reference no.:
		992-5113-1101 992-5113-1171					13101-87303 992-5113-1401	992-5113-1410		90043-84001 90043-84044 90043-84018 90043-84050 90043-84057 90043-84105
NM-Motorservice Article no./ Artikelnummer/ Modelo número/ статья номер	NM-Motorservice Article no.:	NM-Motorservice Article no.:			NM-Motorservice Article no.:		NM-Motorservice Article no.:	NM-Motorservice Article no.:		NM-Motorservice Article no.:
	LBS 10250 F LBS 10250 S	LB 10250 F LB 10250 S			KBS 10250		KB 10250	KR 10250		PB 10250

ENGINE TYPE Motortyp/ tipo de motor/ тип двигателя	LINER KIT Liner Kit/ camisas de los cilindros/ Лайнер комплект	CYL. LINER Zylinderlaufbuchse/ camisas de los cilindros/ втулка цилиндра			PISTON + RINGS Kolben + Ringe/ Pistón + Anillos/ поршень и кольца		PISTON SET Kolben Set/ Pistón Set/ поршневой	RINGS SET Ring Set/ Anillos Set/ кольца		PIN Pin/ Perno/ Пин	
DG 4 Rings			Flanged	No flange	Piston			Rings		Ø : Length:	26.0 70.0
		Length: Outside Ø: Flange Ø: Flange depth:	182.0 93.0 97.0 3.0 +1.0		Length: Comp. height:	95.0 50.5 -1.6 -5.5		Top: 2nd: 3rd: oil:	2.0 2.0 2.0 4.0		
2,530 cc 4 cyl 88.0 mm Bore Ø		Reference no.:					Reference no.:	Reference no.:	Reference no.:		
		11461-87302					13101-87305 13211-87305	13011-87304	90043-84001 90043-84044 90043-84018 90043-84050 90043-84057 90043-84105		
NM-Motorservice Article no./ Artikelnummer/ Modelo número/ статья номер	NM-Motorservice Article no.:	NM-Motorservice Article no.:			NM-Motorservice Article no.:		NM-Motorservice Article no.:	NM-Motorservice Article no.:	NM-Motorservice Article no.:		NM-Motorservice Article no.:
	LBS 59000 F LBS 59000 S	LB 59000 F LB 59000 S			KBS 59000		KB 59000	KR 59000	PB 59000		

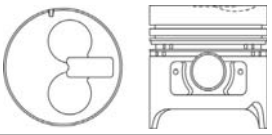

ENGINE TYPE Motortyp/ tipo de motor/ тип двигателя	LINER KIT Liner Kit/ camisas de los cilindros/ Лайнер комплект	CYL. LINER Zylinderlaufbuchse/ camisas de los cilindros/ втулка цилиндра			PISTON + RINGS Kolben + Ringe/ Pistón + Anillos/ поршень и кольца		PISTON SET Kolben Set/ Pistón Set/ поршневой	RINGS SET Ring Set/ Anillos Set/ кольца		PIN Pin/ Perno/ Пин	
DG 3 Rings			Flanged	No flange	Piston			Rings		Ø : Length:	26.0 70.0
		Length: Outside Ø: Flange Ø: Flange depth:	182.0 93.0 97.0 3.0 +1.0		Length: Comp. height:	95.0 50.5 -1.3 -5.3		Top: 2nd: oil:	2.5 2.0 4.0		
2,530 cc 4 cyl 88.0 mm Bore Ø		Reference no.:					Reference no.:	Reference no.:	Reference no.:		
		11461-87302					13101-87306 13101-87309	13011-87305 13011-87306 13011-87307 13011-87308	90043-84001 90043-84044 90043-84018 90043-84050 90043-84057 90043-84105		
NM-Motorservice Article no./ Artikelnummer/ Modelo número/ статья номер	NM-Motorservice Article no.:	NM-Motorservice Article no.:			NM-Motorservice Article no.:		NM-Motorservice Article no.:	NM-Motorservice Article no.:	NM-Motorservice Article no.:		NM-Motorservice Article no.:
	LBS 10300 F LBS 10300 S	LB 10300 F LB 10300 S			KBS 10300		KB 10300	KR 10300	PB 10300		

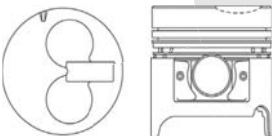

ENGINE TYPE Motortyp/ tipo de motor/ тип двигателя	LINER KIT Liner Kit/ camisas de los cilindros/ Лайнер комплект	CYL. LINER Zylinderlaufbuchse/ camisas de los cilindros/ втулка цилиндра			PISTON + RINGS Kolben + Ringe/ Pistón + Anillos/ поршень и кольца		PISTON SET Kolben Set/ Pistón Set/ поршневой	RINGS SET Ring Set/ Anillos Set/ кольца		PIN Pin/ Perno/ Пин	
DL			Flanged	No flange	Piston			Rings		Ø : Length:	26.0 70.0
		Length: Outside Ø: Flange Ø: Flange depth:	178.0 96.0 101.0 3.0 +1.0		Length: Comp. height:	95.0 50.5 -5.0		Top: 2nd: oil:	2.5 2.0 4.0		
2,765 cc 4 cyl 92.0 mm Bore Ø		Reference no.:					Reference no.:	Reference no.:	Reference no.:		
		11461-87303 11461-87305					13101-87312 13101-87314 13101-87315 13101-87316	13011-87310/1 13011-87312/3 13011-87318 13011-87320/1 13015-87319 13015-87320/A	90043-84001 90043-84044 90043-84018 90043-84050 90043-84057 90043-84105		
NM-Motorservice Article no./ Artikelnummer/ Modelo número/ статья номер	NM-Motorservice Article no.:	NM-Motorservice Article no.:			NM-Motorservice Article no.:		NM-Motorservice Article no.:	NM-Motorservice Article no.:	NM-Motorservice Article no.:		NM-Motorservice Article no.:
	LBS 10350 F LBS 10350 S	LB 10350 F LB 10350 S			KBS 10350		KB 10350	KR 10350	PB 10350		

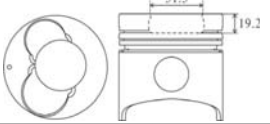

ENGINE TYPE Motortyp/ tipo de motor/ тип двигателя	LINER KIT Liner Kit/ camisas de los cilindros/ Лайнер комплект	CYL. LINER Zylinderlaufbuchse/ camisas de los cilindros/ втулка цилиндра			PISTON + RINGS Kolben + Ringe/ Pistón + Anillos/ поршень и кольца		PISTON SET Kolben Set/ Pistón Set/ поршневой	RINGS SET Ring Set/ Anillos Set/ кольца		PIN Pin/ Perno/ Пин	
DL 2,765 cc 4 cyl 92.0 mm Bore Ø			Flanged	No flange	Piston			Rings			
		Length: Outside Ø: Flange Ø: Flange depth:	178.0 96.0 101.0 3.0 +1.0		Length: Comp. height:	95.0 50.5 -1.2 -5.0		Top: 2nd: oil:	2.5 2.0 4.0	Ø: Length:	26.0 70.0
		Reference no.:					Reference no.:	Reference no.:	Reference no.:		
		11461-87303 11461-87305					13101-87319 13101-87320 13211-87319 13211-87320	13011-87310/1 13011-87312/3 13011-87318 13011-87320/1 13015-87319 13015-87320/A	90043-84052		
NM-Motorservice Article no./ Artikelnummer/ Modelo número/ статья номер	NM-Motorservice Article no.:	NM-Motorservice Article no.:			NM-Motorservice Article no.:		NM-Motorservice Article no.:	NM-Motorservice Article no.:	NM-Motorservice Article no.:		
	LBS 10400 F LBS 10400 S	LB 10400 F LB 10400 S			KBS 10400		KB 10400	KR 10400	PB 10400		

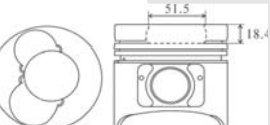

ENGINE TYPE Motortyp/ tipo de motor/ тип двигателя	LINER KIT Liner Kit/ camisas de los cilindros/ Лайнер комплект	CYL. LINER Zylinderlaufbuchse/ camisas de los cilindros/ втулка цилиндра			PISTON + RINGS Kolben + Ringe/ Pistón + Anillos/ поршень и кольца		PISTON SET Kolben Set/ Pistón Set/ поршневой	RINGS SET Ring Set/ Anillos Set/ кольца		PIN Pin/ Perno/ Пин	
DL ROCKY F73 F78 (1993.05-2001.06) 2,765 cc 4 cyl 92.0 mm Bore Ø			Flanged	No flange	Piston			Rings			
		Length: Outside Ø: Flange Ø: Flange depth:	178.0 96.0 101.0 3.0 +1.0		Length: Comp. height:	95.0 50.5 -1.2 -5.2		Top: 2nd: oil:	2.5 2.0 4.0	Ø: Length:	28.0 75.0
		Reference no.:					Reference no.:	Reference no.:	Reference no.:		
		11461-87303 11461-87305					13101-87322 13101-87325 13101-87326 13101-87329 13105-87316 13105-87317 13105-87318	13011-87310/1 13011-87312/3 13011-87318 13011-87320/1 13015-87319 13015-87320/A	90043-84086 90043-84087		
NM-Motorservice Article no./ Artikelnummer/ Modelo número/ статья номер	NM-Motorservice Article no.:	NM-Motorservice Article no.:			NM-Motorservice Article no.:		NM-Motorservice Article no.:	NM-Motorservice Article no.:	NM-Motorservice Article no.:		
	LBS 10450 F LBS 10450 S	LB 10450 F LB 10450 S			KBS 10450		KB 10450	KR 10450	PB 10450		



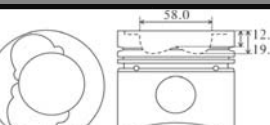

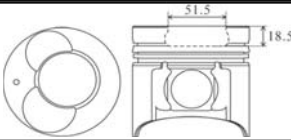

ENGINE TYPE Motortyp/ tipo de motor/ тип двигателя	LINER KIT Liner Kit/ camisas de los cilindros/ Лайнер комплект	CYL. LINER Zylinderlaufbuchse/ camisas de los cilindros/ втулка цилиндра	PISTON + RINGS Kolben + Ringe/ Pistón + Anillos/ поршень и кольца	PISTON SET Kolben Set/ Pistón Set/ поршневой	RINGS SET Ring Set/ Anillos Set/ кольца	PIN Pin/ Perno/ Пин	
W04D 4,009 cc 4 cyl 104.0 mm Bore Ø	Liner OD is graded as W X and Y Z	Liner/ Sleeve	Piston		Rings		Ø : 35.0 Length: 85.0
		Length: Outside Ø: Flange Ø: Flange depth:	201.0 107.0 112.0 8.0 +0.9	Length: Comp. height:	106.2 60.2 -19.2	Top: 2nd: oil:	
		Reference no.:			Reference no.:	Reference no.:	Reference no.:
		11467-1761 11467-1771 11467-1781 11467-1791			13211-1801 13216-1460 13216-1460E	13011-1973 13011-2540 13019-1150	13272-1280 13272-1281
NM-Motorservice Article no./ Artikelnummer/ Modelo número/ статья номер	NM-Motorservice Article no.:	NM-Motorservice Article no.:	NM-Motorservice Article no.:	NM-Motorservice Article no.:	NM-Motorservice Article no.:	NM-Motorservice Article no.:	
	LBS 45000 FA	LB 45000 F (phosphated)	KBS 45000 A	KB 45000 A	KR 45000	PB 45000	

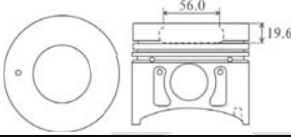

ENGINE TYPE Motortyp/ tipo de motor/ тип двигателя	LINER KIT Liner Kit/ camisas de los cilindros/ Лайнер комплект	CYL. LINER Zylinderlaufbuchse/ camisas de los cilindros/ втулка цилиндра	PISTON + RINGS Kolben + Ringe/ Pistón + Anillos/ поршень и кольца	PISTON SET Kolben Set/ Pistón Set/ поршневой	RINGS SET Ring Set/ Anillos Set/ кольца	PIN Pin/ Perno/ Пин	
W04D New 4,009 cc 4 cyl 104.0 mm Bore Ø	Liner OD is graded as W X and Y Z	Liner/ Sleeve	Piston		Rings		Ø : 35.0 Length: 85.0
		Length: Outside Ø: Flange Ø: Flange depth:	201.0 107.0 112.0 8.0 +0.9	Length: Comp. height:	106.2 60.2 -18.4	Top: 2nd: oil:	
		Reference no.:			Reference no.:	Reference no.:	Reference no.:
		11467-1761 11467-1771 11467-1781 11467-1791			13216-2220	13011-1973 13011-2540 13019-1150	13272-1280 13272-1281
NM-Motorservice Article no./ Artikelnummer/ Modelo número/ статья номер	NM-Motorservice Article no.:	NM-Motorservice Article no.:	NM-Motorservice Article no.:	NM-Motorservice Article no.:	NM-Motorservice Article no.:	NM-Motorservice Article no.:	
	LBS 10550 FA	LB 10550 F (phosphated)	KBS 10550 A	KB 10550 A	KR 10550	PB 10550	

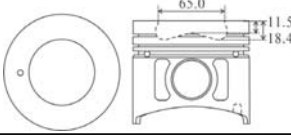

ENGINE TYPE Motortyp/ tipo de motor/ тип двигателя	LINER KIT Liner Kit/ camisas de los cilindros/ Лайнер комплект	CYL. LINER Zylinderlaufbuchse/ camisas de los cilindros/ втулка цилиндра	PISTON + RINGS Kolben + Ringe/ Pistón + Anillos/ поршень и кольца	PISTON SET Kolben Set/ Pistón Set/ поршневой	RINGS SET Ring Set/ Anillos Set/ кольца	PIN Pin/ Perno/ Пин	
W04CT 4,009 cc 4 cyl 104.0 mm Bore Ø	Liner OD is graded as W X and Y Z	Liner/ Sleeve	Piston		Rings		Ø : 37.0 Length: 85.0
		Length: Outside Ø: Flange Ø: Flange depth:	201.0 107.0 112.0 8.0 -0.9	Length: Comp. height:	108.7 62.7 -12.7 -19.4	Top: 2nd: oil:	
		Reference no.:			Reference no.:	Reference no.:	Reference no.:
		11467-1761 11467-1771 11467-1781 11467-1791			13216-1631 S1321-61631	13011-2270 13011-2270A 13011-2270C 13011-2550 13011-2550B 13019-1160A	
NM-Motorservice Article no./ Artikelnummer/ Modelo número/ статья номер	NM-Motorservice Article no.:	NM-Motorservice Article no.:	NM-Motorservice Article no.:	NM-Motorservice Article no.:	NM-Motorservice Article no.:	NM-Motorservice Article no.:	
	LBS 10600 FA	LB 10600 F (phosphated)	KBS 10600 A	KB 10600 A	KR 10600	PB 10600	

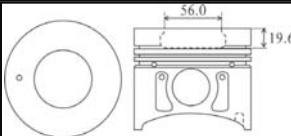

ENGINE TYPE Motortyp/ tipo de motor/ тип двигателя	LINER KIT Liner Kit/ camisas de los cilindros/ Лайнер комплект	CYL. LINER Zylinderlaufbuchse/ camisas de los cilindros/ втулка цилиндра	PISTON + RINGS Kolben + Ringe/ Pistón + Anillos/ поршень и кольца	PISTON SET Kolben Set/ Pistón Set/ поршневой	RINGS SET Ring Set/ Anillos Set/ кольца	PIN Pin/ Perno/ Пин
W04DT 4,009 cc 4 cyl 104.0 mm Bore Ø	Liner OD is graded as W X and Y Z		Piston		Rings	
		Length: 201.0 Outside Ø: 107.0 Flange Ø: 112.0 Flange depth: 8.0 +0.9	Length: 106.2 Comp. height: 60.2 -18.5	Top: 2.5 2nd: 2.0 oil: 4.0	Ø: 37.0 Length: 85.0	
		Reference no.:		Reference no.:	Reference no.:	Reference no.:
		11467-1761 11467-1771 11467-1781 11467-1791 OD is graded as W X and Y Z		13216-3201	13011-3950/A 13011-4020/A 13011-70060 13011-E0110 13019-1190A 13019-1200A	
NM-Motorservice Article no./ Artikelnummer/ Modelo número/ статья номер	NM-Motorservice Article no.:	NM-Motorservice Article no.:	NM-Motorservice Article no.:	NM-Motorservice Article no.:	NM-Motorservice Article no.:	NM-Motorservice Article no.:
	LBS 10650 FA	LB 10650 F (phosphated)	KBS 10650 A	KB 10650 A	KR 10650	PB 10650

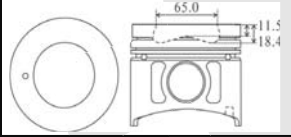

ENGINE TYPE Motortyp/ tipo de motor/ тип двигателя	LINER KIT Liner Kit/ camisas de los cilindros/ Лайнер комплект	CYL. LINER Zylinderlaufbuchse/ camisas de los cilindros/ втулка цилиндра	PISTON + RINGS Kolben + Ringe/ Pistón + Anillos/ поршень и кольца	PISTON SET Kolben Set/ Pistón Set/ поршневой	RINGS SET Ring Set/ Anillos Set/ кольца	PIN Pin/ Perno/ Пин
J05C 5,307 cc 4 cyl 114.0 mm Bore Ø	Liner OD is graded as A, B and C		Piston		Rings	
		Length: 204.0 Outside Ø: 117.0 Flange Ø: 122.0 Flange depth: 8.0 +0.8	Length: 100.0 Comp. height: 57.1 -19.6	Top: 3.0 2nd: 2.0 oil: 4.0	Ø: 37.0 Length: 84.5	
		Reference no.:		Reference no.:	Reference no.:	Reference no.:
		11461-78060/70/80 11467-2601/11/21 11467-2780/90/800		13216-2631	13011-3391B	13271-1420 13272-1300B 13272-1381
NM-Motorservice Article no./ Artikelnummer/ Modelo número/ статья номер	NM-Motorservice Article no.:	NM-Motorservice Article no.:	NM-Motorservice Article no.:	NM-Motorservice Article no.:	NM-Motorservice Article no.:	NM-Motorservice Article no.:
	LBS 10700 FA	LB 10700 F (phosphated)	KBS 10700 A	KB 10700 A	KR 10700	PB 10700

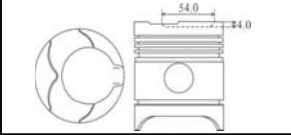

ENGINE TYPE Motortyp/ tipo de motor/ тип двигателя	LINER KIT Liner Kit/ camisas de los cilindros/ Лайнер комплект	CYL. LINER Zylinderlaufbuchse/ camisas de los cilindros/ втулка цилиндра	PISTON + RINGS Kolben + Ringe/ Pistón + Anillos/ поршень и кольца	PISTON SET Kolben Set/ Pistón Set/ поршневой	RINGS SET Ring Set/ Anillos Set/ кольца	PIN Pin/ Perno/ Пин
J05CT 5,307 cc 4 cyl 114.0 mm Bore Ø	Liner OD is graded as A, B and C		Piston	Alfin and with oil gallery pin bushing inserted	Rings	
		Length: 204.0 Outside Ø: 117.0 Flange Ø: 122.0 Flange depth: 8.0 +0.8	Length: 100.0 Comp. height: 57.0 -11.5 -18.4	Top: 2.5 2nd: 2.0 oil: 4.0	Ø: 37.0 Length: 85.0	
		Reference no.:		Reference no.:	Reference no.:	Reference no.:
		11461-78060/70/80 11467-2601/11/21 11467-2780/90/800		13306-1080	13011-3880A 13011-3940A 13019-1010B	13271-1420 13272-1300B 13272-1381
NM-Motorservice Article no./ Artikelnummer/ Modelo número/ статья номер	NM-Motorservice Article no.:	NM-Motorservice Article no.:	NM-Motorservice Article no.:	NM-Motorservice Article no.:	NM-Motorservice Article no.:	NM-Motorservice Article no.:
	LBS 10750 FB	LB 10750 F (phosphated)	KBS 10750 B	KB 10750 B	KR 10750	PB 10750

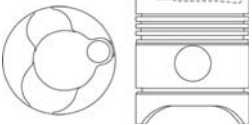

ENGINE TYPE Motortyp/ tipo de motor/ тип двигателя	LINER KIT Liner Kit/ camisas de los cilindros/ Лайнер комплект	CYL. LINER Zylinderlaufbuchse/ camisas de los cilindros/ втулка цилиндра	PISTON + RINGS Kolben + Ringe/ Pistón + Anillos/ поршень и кольца	PISTON SET Kolben Set/ Pistón Set/ поршневой	RINGS SET Ring Set/ Anillos Set/ кольца	PIN Pin/ Perno/ Пин	
J07C 6,634 cc 5 cyl 114.0 mm Bore Ø	Liner OD is graded as A, B and C	Liner/ Sleeve	Piston		Rings		
		Length: Outside Ø: Flange Ø: Flange depth:	204.0 117.0 122.0 8.0 +0.8	Length: Comp. height:	100.0 57.1 -19.6	Top: 2nd: oil:	3.0 2.0 4.0
		Reference no.:		Reference no.:	Reference no.:	Reference no.:	
		11461-78060/70/80 11467-2601/11/21 11467-2780/90/800		13216-2631	13011-3371B 13011-3771A	13271-1420 13272-1300B 13272-1381	
NM-Motorservice Article no./ Artikelnummer/ Modelo número/ статья номер	NM-Motorservice Article no.:	NM-Motorservice Article no.:	NM-Motorservice Article no.:	NM-Motorservice Article no.:	NM-Motorservice Article no.:	NM-Motorservice Article no.:	
	LBS 10800 FA	LB 10800 F (phosphated)	KBS 10800 A	KB 10800 A	KR 10800	PB 10800	

ENGINE TYPE Motortyp/ tipo de motor/ тип двигателя	LINER KIT Liner Kit/ camisas de los cilindros/ Лайнер комплект	CYL. LINER Zylinderlaufbuchse/ camisas de los cilindros/ втулка цилиндра	PISTON + RINGS Kolben + Ringe/ Pistón + Anillos/ поршень и кольца	PISTON SET Kolben Set/ Pistón Set/ поршневой	RINGS SET Ring Set/ Anillos Set/ кольца	PIN Pin/ Perno/ Пин		
J07CT 6,634 cc 5 cyl 114.0 mm Bore Ø	Liner OD is graded as A, B and C	Liner/ Sleeve	Piston		Alfin and with oil gallery pin bushing inserted	Rings		
		Length: Outside Ø: Flange Ø: Flange depth:	204.00 117.0 122.0 8.0 +0.8	Length: Comp. height:		100.00 57.0 -11.5 -18.4	Top: 2nd: oil:	2.5 2.0 4.0
		Reference no.:		Reference no.:	Reference no.:	Reference no.:		
		11461-78060/70/80 11467-2601/11/21 11467-2780/90/800		13306-1080	13011-3660A 13011-3900A	13271-1420 13272-1300B 13272-1381		
NM-Motorservice Article no./ Artikelnummer/ Modelo número/ статья номер	NM-Motorservice Article no.:	NM-Motorservice Article no.:	NM-Motorservice Article no.:	NM-Motorservice Article no.:	NM-Motorservice Article no.:	NM-Motorservice Article no.:		
	LBS 10850 FB	LB 10850 F (phosphated)	KBS 10850 B	KB 10850 B	KR 10850	PB 10850		

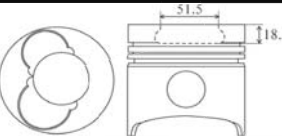
ENGINE TYPE Motortyp/ tipo de motor/ тип двигателя	LINER KIT Liner Kit/ camisas de los cilindros/ Лайнер комплект	CYL. LINER Zylinderlaufbuchse/ camisas de los cilindros/ втулка цилиндра	PISTON + RINGS Kolben + Ringe/ Pistón + Anillos/ поршень и кольца	PISTON SET Kolben Set/ Pistón Set/ поршневой	RINGS SET Ring Set/ Anillos Set/ кольца	PIN Pin/ Perno/ Пин	
DM100 KM 4,313 cc 6 cyl 90.0 mm Bore Ø		Liner/ Sleeve	Piston		Rings		
		Length: Outside Ø: Flange Ø: Flange depth:	198.5 104.5 110.0 9.0 +1.0	Length: Comp. height:	104.0 53.8 -1.7 -4.0	Top: 2nd: 3rd: 1st oil: 2nd oil:	2.5 2.5 2.5 4.0 4.0
		Reference no.:		Reference no.:	Reference no.:	Reference no.:	
		11467-1401 11467-1440 2352-1695-01		13216-1120 13216-1120A 3352-1961-00	13011-1350 13011-1350A	13272-1130	
NM-Motorservice Article no./ Artikelnummer/ Modelo número/ статья номер	NM-Motorservice Article no.:	NM-Motorservice Article no.:	NM-Motorservice Article no.:	NM-Motorservice Article no.:	NM-Motorservice Article no.:	NM-Motorservice Article no.:	
	LBS 10900 F	LB 10900 F	KBS 10900	KB 10900	KR 10900	PB 10900	

ENGINE TYPE Motortyp/ tipo de motor/ тип двигателя	LINER KIT Liner Kit/ camisas de los cilindros/ Лайнер комплект	CYL. LINER Zylinderlaufbuchse/ camisas de los cilindros/ втулка цилиндра	PISTON + RINGS Kolben + Ringe/ Pistón + Anillos/ поршень и кольца		PISTON SET Kolben Set/ Pistón Set/ поршневой	RINGS SET Ring Set/ Anillos Set/ кольца	PIN Pin/ Perno/ Пин																																			
EC100 KL 5,010 cc 6 cyl 97.0 mm Bore Ø		<table border="1"> <tr> <td></td> <td>Liner/ Sleeve</td> <td></td> </tr> <tr> <td>Length:</td> <td>206.0</td> <td></td> </tr> <tr> <td>Outside Ø:</td> <td>110.5</td> <td></td> </tr> <tr> <td>Flange Ø:</td> <td>117.0</td> <td></td> </tr> <tr> <td>Flange depth:</td> <td>10.0 +1.0</td> <td></td> </tr> </table>		Liner/ Sleeve		Length:	206.0		Outside Ø:	110.5		Flange Ø:	117.0		Flange depth:	10.0 +1.0		<table border="1"> <tr> <td></td> <td>Piston</td> </tr> <tr> <td>Length:</td> <td>112.0</td> </tr> <tr> <td>Comp. height:</td> <td>58.0 -4.2 -6.1</td> </tr> </table>			Piston	Length:	112.0	Comp. height:	58.0 -4.2 -6.1		<table border="1"> <tr> <td>Top:</td> <td>2.5</td> </tr> <tr> <td>2nd:</td> <td>2.5</td> </tr> <tr> <td>3rd:</td> <td>2.5</td> </tr> <tr> <td>1st oil:</td> <td>4.0</td> </tr> <tr> <td>2nd oil:</td> <td>4.0</td> </tr> </table>	Top:	2.5	2nd:	2.5	3rd:	2.5	1st oil:	4.0	2nd oil:	4.0	<table border="1"> <tr> <td>Ø:</td> <td>31.5</td> </tr> <tr> <td>Length:</td> <td>81.5</td> </tr> </table>	Ø:	31.5	Length:	81.5
				Liner/ Sleeve																																						
Length:	206.0																																									
Outside Ø:	110.5																																									
Flange Ø:	117.0																																									
Flange depth:	10.0 +1.0																																									
	Piston																																									
Length:	112.0																																									
Comp. height:	58.0 -4.2 -6.1																																									
Top:	2.5																																									
2nd:	2.5																																									
3rd:	2.5																																									
1st oil:	4.0																																									
2nd oil:	4.0																																									
Ø:	31.5																																									
Length:	81.5																																									
		Reference no.:		Reference no.:	Reference no.:	Reference no.:																																				
		11467-1130 11467-1130A 11467-1491 2353-8019-10 2353-8019-30		13216-1140 13216-1140C 2380-1940-01	13011-1390 13011-1400	13272-1140																																				
NM-Motorservice Article no./ Artikelnummer/ Modelo número/ статья номер	NM-Motorservice Article no.:	NM-Motorservice Article no.:	NM-Motorservice Article no.:	NM-Motorservice Article no.:	NM-Motorservice Article no.:	NM-Motorservice Article no.:																																				
	LBS 10950 F	LB 10950 F	KBS 10950	KB 10950	KR 10950	PB 10950																																				

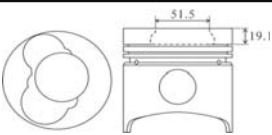

ENGINE TYPE Motortyp/ tipo de motor/ тип двигателя	LINER KIT Liner Kit/ camisas de los cilindros/ Лайнер комплект	CYL. LINER Zylinderlaufbuchse/ camisas de los cilindros/ втулка цилиндра	PISTON + RINGS Kolben + Ringe/ Pistón + Anillos/ поршень и кольца		PISTON SET Kolben Set/ Pistón Set/ поршневой	RINGS SET Ring Set/ Anillos Set/ кольца	PIN Pin/ Perno/ Пин																													
W06D 5,759 cc 6 cyl 104.0 mm Bore Ø	Liner OD is graded as W X and Y Z	<table border="1"> <tr> <td></td> <td>Liner/ Sleeve</td> <td></td> </tr> <tr> <td>Length:</td> <td>201.0</td> <td></td> </tr> <tr> <td>Outside Ø:</td> <td>107.0</td> <td></td> </tr> <tr> <td>Flange Ø:</td> <td>112.0</td> <td></td> </tr> <tr> <td>Flange depth:</td> <td>8.0 +0.9</td> <td></td> </tr> </table>		Liner/ Sleeve		Length:	201.0		Outside Ø:	107.0		Flange Ø:	112.0		Flange depth:	8.0 +0.9		<table border="1"> <tr> <td></td> <td>Piston</td> </tr> <tr> <td>Length:</td> <td>108.7</td> </tr> <tr> <td>Comp. height:</td> <td>62.6 -4.0 -18.5</td> </tr> </table>			Piston	Length:	108.7	Comp. height:	62.6 -4.0 -18.5		<table border="1"> <tr> <td>Top:</td> <td>2.5</td> </tr> <tr> <td>2nd: oil:</td> <td>2.0 5.5</td> </tr> </table>	Top:	2.5	2nd: oil:	2.0 5.5	<table border="1"> <tr> <td>Ø:</td> <td>35.0</td> </tr> <tr> <td>Length:</td> <td>85.0</td> </tr> </table>	Ø:	35.0	Length:	85.0
				Liner/ Sleeve																																
Length:	201.0																																			
Outside Ø:	107.0																																			
Flange Ø:	112.0																																			
Flange depth:	8.0 +0.9																																			
	Piston																																			
Length:	108.7																																			
Comp. height:	62.6 -4.0 -18.5																																			
Top:	2.5																																			
2nd: oil:	2.0 5.5																																			
Ø:	35.0																																			
Length:	85.0																																			
		Reference no.:		Reference no.:	Reference no.:	Reference no.:																														
		11467-1761 11467-1771 11467-1781 11467-1791		13216-1470 13216-1470D 13216-1470E	13011-1983 13011-2420 13011-2440	13272-1280 13272-1281																														
NM-Motorservice Article no./ Artikelnummer/ Modelo número/ статья номер	NM-Motorservice Article no.:	NM-Motorservice Article no.:	NM-Motorservice Article no.:	NM-Motorservice Article no.:	NM-Motorservice Article no.:	NM-Motorservice Article no.:																														
	LBS 45150 FA	LB 45150 F (phosphated)	KBS 45150 A	KB 45150 A	KR 45150	PB 45150																														



ENGINE TYPE Motortyp/ tipo de motor/ тип двигателя	LINER KIT Liner Kit/ camisas de los cilindros/ Лайнер комплект	CYL. LINER Zylinderlaufbuchse/ camisas de los cilindros/ втулка цилиндра	PISTON + RINGS Kolben + Ringe/ Pistón + Anillos/ поршень и кольца		PISTON SET Kolben Set/ Pistón Set/ поршневой	RINGS SET Ring Set/ Anillos Set/ кольца	PIN Pin/ Perno/ Пин																													
W06E 6,014 cc 6 cyl 104.0 mm Bore Ø	Liner OD is graded as W X and Y Z	<table border="1"> <tr> <td></td> <td>Liner/ Sleeve</td> <td></td> </tr> <tr> <td>Length:</td> <td>201.0</td> <td></td> </tr> <tr> <td>Outside Ø:</td> <td>107.0</td> <td></td> </tr> <tr> <td>Flange Ø:</td> <td>112.0</td> <td></td> </tr> <tr> <td>Flange depth:</td> <td>8.0 +0.9</td> <td></td> </tr> </table>		Liner/ Sleeve		Length:	201.0		Outside Ø:	107.0		Flange Ø:	112.0		Flange depth:	8.0 +0.9		<table border="1"> <tr> <td></td> <td>Piston</td> </tr> <tr> <td>Length:</td> <td>106.2</td> </tr> <tr> <td>Comp. height:</td> <td>60.2 -19.1</td> </tr> </table>			Piston	Length:	106.2	Comp. height:	60.2 -19.1		<table border="1"> <tr> <td>Top:</td> <td>2.5</td> </tr> <tr> <td>2nd: oil:</td> <td>2.0 5.0</td> </tr> </table>	Top:	2.5	2nd: oil:	2.0 5.0	<table border="1"> <tr> <td>Ø:</td> <td>35.0</td> </tr> <tr> <td>Length:</td> <td>85.0</td> </tr> </table>	Ø:	35.0	Length:	85.0
				Liner/ Sleeve																																
Length:	201.0																																			
Outside Ø:	107.0																																			
Flange Ø:	112.0																																			
Flange depth:	8.0 +0.9																																			
	Piston																																			
Length:	106.2																																			
Comp. height:	60.2 -19.1																																			
Top:	2.5																																			
2nd: oil:	2.0 5.0																																			
Ø:	35.0																																			
Length:	85.0																																			
		Reference no.:		Reference no.:	Reference no.:	Reference no.:																														
		11467-1761 11467-1771 11467-1781 11467-1791		13211-2070 13216-1720 13216-1720B	13011-1983 13011-2420 13011-2440	13272-1280 13272-1281																														
NM-Motorservice Article no./ Artikelnummer/ Modelo número/ статья номер	NM-Motorservice Article no.:	NM-Motorservice Article no.:	NM-Motorservice Article no.:	NM-Motorservice Article no.:	NM-Motorservice Article no.:	NM-Motorservice Article no.:																														
	LBS 11050 FA	LB 11050 F (phosphated)	KBS 11050 A	KB 11050 A	KR 11050	PB 11050																														

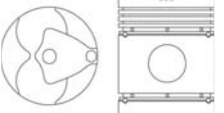

ENGINE TYPE Motortyp/ tipo de motor/ тип двигателя	LINER KIT Liner Kit/ camisas de los cilindros/ Лайнер комплект	CYL. LINER Zylinderlaufbuchse/ camisas de los cilindros/ втулка цилиндра	PISTON + RINGS Kolben + Ringe/ Pistón + Anillos/ поршень и кольца	PISTON SET Kolben Set/ Pistón Set/ поршневой	RINGS SET Ring Set/ Anillos Set/ кольца	PIN Pin/ Perno/ Пин																																									
W06D New 5,759 cc 6 cyl 104.0 mm Bore Ø	Liner OD is graded as W X and Y Z																																														
		<table border="1"> <tr> <td></td> <td>Liner/ Sleeve</td> <td></td> <td></td> <td></td> </tr> <tr> <td>Length:</td> <td>201.0</td> <td></td> <td></td> <td></td> </tr> <tr> <td>Outside Ø:</td> <td>107.0</td> <td></td> <td></td> <td></td> </tr> <tr> <td>Flange Ø:</td> <td>112.0</td> <td></td> <td></td> <td></td> </tr> <tr> <td>Flange depth:</td> <td>8.0 +0.9</td> <td></td> <td></td> <td></td> </tr> </table>		Liner/ Sleeve				Length:	201.0				Outside Ø:	107.0				Flange Ø:	112.0				Flange depth:	8.0 +0.9				<table border="1"> <tr> <td></td> <td>Piston</td> </tr> <tr> <td>Length:</td> <td>106.2</td> </tr> <tr> <td>Comp. height:</td> <td>60.2 -18.4</td> </tr> </table>		Piston	Length:	106.2	Comp. height:	60.2 -18.4		<table border="1"> <tr> <td></td> <td>Rings</td> </tr> <tr> <td>Top:</td> <td>2.5</td> </tr> <tr> <td>2nd: oil:</td> <td>2.0 5.0</td> </tr> <tr> <td>Ø:</td> <td>35.0</td> </tr> <tr> <td>Length:</td> <td>85.0</td> </tr> </table>		Rings	Top:	2.5	2nd: oil:	2.0 5.0	Ø:	35.0	Length:	85.0	
	Liner/ Sleeve																																														
Length:	201.0																																														
Outside Ø:	107.0																																														
Flange Ø:	112.0																																														
Flange depth:	8.0 +0.9																																														
	Piston																																														
Length:	106.2																																														
Comp. height:	60.2 -18.4																																														
	Rings																																														
Top:	2.5																																														
2nd: oil:	2.0 5.0																																														
Ø:	35.0																																														
Length:	85.0																																														
		Reference no.:		Reference no.:	Reference no.:	Reference no.:																																									
		11467-1761 11467-1771 11467-1781 11467-1791		13216-2220	13011-1983 13011-2420 13011-2440	13272-1280 13272-1281																																									
NM-Motorservice Article no./ Artikelnummer/ Modelo número/ статья номер	NM-Motorservice Article no.:	NM-Motorservice Article no.:	NM-Motorservice Article no.:	NM-Motorservice Article no.:	NM-Motorservice Article no.:	NM-Motorservice Article no.:																																									
	LBS 11100 FA	LB 11100 F (phosphated)	KBS 11100 A	KB 11100 A	KR 11100	PB 11100																																									

ENGINE TYPE Motortyp/ tipo de motor/ тип двигателя	LINER KIT Liner Kit/ camisas de los cilindros/ Лайнер комплект	CYL. LINER Zylinderlaufbuchse/ camisas de los cilindros/ втулка цилиндра	PISTON + RINGS Kolben + Ringe/ Pistón + Anillos/ поршень и кольца	PISTON SET Kolben Set/ Pistón Set/ поршневой	RINGS SET Ring Set/ Anillos Set/ кольца	PIN Pin/ Perno/ Пин																																									
W06DT 5,759 cc 6 cyl 104.0 mm Bore Ø	Liner OD is graded as W X and Y Z																																														
		<table border="1"> <tr> <td></td> <td>Liner/ Sleeve</td> <td></td> <td></td> <td></td> </tr> <tr> <td>Length:</td> <td>201.0</td> <td></td> <td></td> <td></td> </tr> <tr> <td>Outside Ø:</td> <td>107.0</td> <td></td> <td></td> <td></td> </tr> <tr> <td>Flange Ø:</td> <td>112.0</td> <td></td> <td></td> <td></td> </tr> <tr> <td>Flange depth:</td> <td>8.0 +0.9</td> <td></td> <td></td> <td></td> </tr> </table>		Liner/ Sleeve				Length:	201.0				Outside Ø:	107.0				Flange Ø:	112.0				Flange depth:	8.0 +0.9				<table border="1"> <tr> <td></td> <td>Piston</td> </tr> <tr> <td>Length:</td> <td>108.7</td> </tr> <tr> <td>Comp. height:</td> <td>62.7 -12.7 -19.4</td> </tr> </table>		Piston	Length:	108.7	Comp. height:	62.7 -12.7 -19.4		<table border="1"> <tr> <td></td> <td>Rings</td> </tr> <tr> <td>Top:</td> <td>2.8</td> </tr> <tr> <td>2nd: oil:</td> <td>2.5 5.0</td> </tr> <tr> <td>Ø:</td> <td>37.0</td> </tr> <tr> <td>Length:</td> <td>85.0</td> </tr> </table>		Rings	Top:	2.8	2nd: oil:	2.5 5.0	Ø:	37.0	Length:	85.0	
	Liner/ Sleeve																																														
Length:	201.0																																														
Outside Ø:	107.0																																														
Flange Ø:	112.0																																														
Flange depth:	8.0 +0.9																																														
	Piston																																														
Length:	108.7																																														
Comp. height:	62.7 -12.7 -19.4																																														
	Rings																																														
Top:	2.8																																														
2nd: oil:	2.5 5.0																																														
Ø:	37.0																																														
Length:	85.0																																														
		Reference no.:		Reference no.:	Reference no.:	Reference no.:																																									
		11467-1761 11467-1771 11467-1781 11467-1791		13211-1982	13011-2610A 13011-2950A 13011-2680A	13271-1420 13272-1300B 13272-1381																																									
NM-Motorservice Article no./ Artikelnummer/ Modelo número/ статья номер	NM-Motorservice Article no.:	NM-Motorservice Article no.:	NM-Motorservice Article no.:	NM-Motorservice Article no.:	NM-Motorservice Article no.:	NM-Motorservice Article no.:																																									
	LBS 11150 FA	LB 11150 F (phosphated)	KBS 11150 A	KB 11150 A	KR 11150	PB 11150																																									

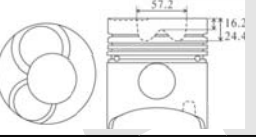
ENGINE TYPE Motortyp/ tipo de motor/ тип двигателя	LINER KIT Liner Kit/ camisas de los cilindros/ Лайнер комплект	CYL. LINER Zylinderlaufbuchse/ camisas de los cilindros/ втулка цилиндра	PISTON + RINGS Kolben + Ringe/ Pistón + Anillos/ поршень и кольца	PISTON SET Kolben Set/ Pistón Set/ поршневой	RINGS SET Ring Set/ Anillos Set/ кольца	PIN Pin/ Perno/ Пин																																															
EH100 KR 5,871 cc 6 cyl 105.0 mm Bore Ø																																																					
		<table border="1"> <tr> <td></td> <td>Liner/ Sleeve</td> <td></td> <td></td> <td></td> </tr> <tr> <td>Length:</td> <td>204.0</td> <td></td> <td></td> <td></td> </tr> <tr> <td>Outside Ø:</td> <td>110.0</td> <td></td> <td></td> <td></td> </tr> <tr> <td>Flange Ø:</td> <td>115.0</td> <td></td> <td></td> <td></td> </tr> <tr> <td>Flange depth:</td> <td>8.0 +0.5</td> <td></td> <td></td> <td></td> </tr> </table>		Liner/ Sleeve				Length:	204.0				Outside Ø:	110.0				Flange Ø:	115.0				Flange depth:	8.0 +0.5				<table border="1"> <tr> <td></td> <td>Piston</td> </tr> <tr> <td>Length:</td> <td>112.0</td> </tr> <tr> <td>Comp. height:</td> <td>59.0 -6.4</td> </tr> </table>		Piston	Length:	112.0	Comp. height:	59.0 -6.4		<table border="1"> <tr> <td></td> <td>Rings</td> </tr> <tr> <td>Top:</td> <td>2.5</td> </tr> <tr> <td>2nd:</td> <td>2.5</td> </tr> <tr> <td>3rd:</td> <td>2.5</td> </tr> <tr> <td>1st oil:</td> <td>4.0</td> </tr> <tr> <td>2nd oil:</td> <td>4.0</td> </tr> <tr> <td>Ø:</td> <td>34.0</td> </tr> <tr> <td>Length:</td> <td>89.5</td> </tr> </table>		Rings	Top:	2.5	2nd:	2.5	3rd:	2.5	1st oil:	4.0	2nd oil:	4.0	Ø:	34.0	Length:	89.5	
	Liner/ Sleeve																																																				
Length:	204.0																																																				
Outside Ø:	110.0																																																				
Flange Ø:	115.0																																																				
Flange depth:	8.0 +0.5																																																				
	Piston																																																				
Length:	112.0																																																				
Comp. height:	59.0 -6.4																																																				
	Rings																																																				
Top:	2.5																																																				
2nd:	2.5																																																				
3rd:	2.5																																																				
1st oil:	4.0																																																				
2nd oil:	4.0																																																				
Ø:	34.0																																																				
Length:	89.5																																																				
		Reference no.:		Reference no.:	Reference no.:	Reference no.:																																															
		11467-1030 11467-1040		13216-1010 2382-1961-00	13011-1150 13011-1410	13271-1030																																															
NM-Motorservice Article no./ Artikelnummer/ Modelo número/ статья номер	NM-Motorservice Article no.:	NM-Motorservice Article no.:	NM-Motorservice Article no.:	NM-Motorservice Article no.:	NM-Motorservice Article no.:	NM-Motorservice Article no.:																																															
	LBS 11200 F	LB 11200 F	KBS 11200	KB 11200	KR 11200	PB 11200																																															

ENGINE TYPE Motortyp/ tipo de motor/ тип двигателя	LINER KIT Liner Kit/ camisas de los cilindros/ Лайнер комплект	CYL. LINER Zylinderlaufbuchse/ camisas de los cilindros/ втулка цилиндра	PISTON + RINGS Kolben + Ringe/ Pistón + Anillos/ поршень и кольца	PISTON SET Kolben Set/ Pistón Set/ поршневой	RINGS SET Ring Set/ Anillos Set/ кольца	PIN Pin/ Perno/ Пин	
DS70 7,014 cc 6 cyl 105.0 mm Bore Ø		Liner/ Sleeve	Piston		Rings		Ø : 40.0 Length: 82.0
		Length: 261.0 Outside Ø: 122.0 Flange Ø: 130.0 Flange depth: 10.0 +1.0	Length: 140.0 Comp. height: 78.5 -1.7 -9.0	Top: 3.0 2nd: 3.0 3rd: 3.0 1st oil: 4.5 2nd oil: 4.5			
		Reference no.:			Reference no.:	Reference no.:	Reference no.:
		11467-1280			13216-1221 2303-1202-00	13011-1210 13011-1550A	13272-1070 13272-1180
NM-Motorservice Article no./ Artikelnummer/ Modelo número/ статья номер	NM-Motorservice Article no.:	NM-Motorservice Article no.:	NM-Motorservice Article no.:	NM-Motorservice Article no.:	NM-Motorservice Article no.:	NM-Motorservice Article no.:	
	LBS 11250 F	LB 11250 F	KBS 11250	KB 11250	KR 11250	PB 11250	

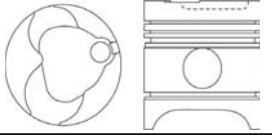

ENGINE TYPE Motortyp/ tipo de motor/ тип двигателя	LINER KIT Liner Kit/ camisas de los cilindros/ Лайнер комплект	CYL. LINER Zylinderlaufbuchse/ camisas de los cilindros/ втулка цилиндра	PISTON + RINGS Kolben + Ringe/ Pistón + Anillos/ поршень и кольца	PISTON SET Kolben Set/ Pistón Set/ поршневой	RINGS SET Ring Set/ Anillos Set/ кольца	PIN Pin/ Perno/ Пин	
H06BT 6,224 cc 6 cyl 105.8 mm Bore Ø	Liner OD is graded as W X and Y Z	Liner/ Sleeve	Piston		Rings		Ø : 39.0 Length: 87.5
		Length: 204.0 Outside Ø: 110.0 Flange Ø: 118.0 Flange depth: 8.0 +0.7	Length: 121.5 Comp. height: 69.5 -16.2 -24.4	Top: 2.8 2nd: 2.5 3rd: 2.5 oil: 5.0			
		Reference no.:			Reference no.:	Reference no.:	Reference no.:
		11467-1921 11467-1931 11467-1941 11467-1951			13216-1591	13011-2880A	13272-1270
NM-Motorservice Article no./ Artikelnummer/ Modelo número/ статья номер	NM-Motorservice Article no.:	NM-Motorservice Article no.:	NM-Motorservice Article no.:	NM-Motorservice Article no.:	NM-Motorservice Article no.:	NM-Motorservice Article no.:	
	LBS 11300 FA	LB 11300 F (phosphated)	KBS 11300 A	KB 11300 A	KR 11300	PB 11300	



ENGINE TYPE Motortyp/ tipo de motor/ тип двигателя	LINER KIT Liner Kit/ camisas de los cilindros/ Лайнер комплект	CYL. LINER Zylinderlaufbuchse/ camisas de los cilindros/ втулка цилиндра	PISTON + RINGS Kolben + Ringe/ Pistón + Anillos/ поршень и кольца	PISTON SET Kolben Set/ Pistón Set/ поршневой	RINGS SET Ring Set/ Anillos Set/ кольца	PIN Pin/ Perno/ Пин	
EH300 6,211 cc 6 cyl 108.0 mm Bore Ø	Liner OD is graded as A and B	Liner/ Sleeve	Piston		Rings		Ø : 35.0 Length: 90.0
		Length: 204.0 Outside Ø: 112.0 Flange Ø: 118.0 Flange depth: 8.0 +0.6	Length: 114.0 Comp. height: 59.5 -7.0	Top: 3.0 2nd: 2.5 1st oil: 5.0 2nd oil: 4.0			
		Reference no.:			Reference no.:	Reference no.:	Reference no.:
		11467-1010 11467-1020			13216-1160	13011-1032 13011-1032A 13011-1062	13272-1030
NM-Motorservice Article no./ Artikelnummer/ Modelo número/ статья номер	NM-Motorservice Article no.:	NM-Motorservice Article no.:	NM-Motorservice Article no.:	NM-Motorservice Article no.:	NM-Motorservice Article no.:	NM-Motorservice Article no.:	
	LBS 11350 F	LB 11350 F (phosphated)	KBS 11350	KB 11350	KR 11350	PB 11350	

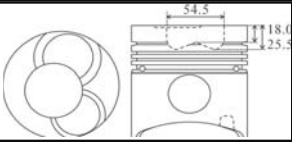

ENGINE TYPE Motortyp/ tipo de motor/ тип двигателя	LINER KIT Liner Kit/ camisas de los cilindros/ Лайнер комплект	CYL. LINER Zylinderlaufbuchse/ camisas de los cilindros/ втулка цилиндра	PISTON + RINGS Kolben + Ringe/ Pistón + Anillos/ поршень и кольца	PISTON SET Kolben Set/ Pistón Set/ поршневой	RINGS SET Ring Set/ Anillos Set/ кольца	PIN Pin/ Perno/ Пин	
H06C 6,485 cc 6 cyl 108.0 mm Bore Ø	Liner OD is graded as W X and Y Z	Liner/ Sleeve	Piston		Rings		Ø : 39.0 Length: 90.0
		Length: Outside Ø: Flange Ø: Flange depth:	204.0 113.0 118.0 8.0 +1.0	Length: Comp. height:	121.5 69.5 -17.7 -25.5	Top: 2nd: 3rd: oil:	
	Reference no.:	Reference no.:		Reference no.:	Reference no.:	Reference no.:	
		11467-1591 11467-1601 11467-1611 11467-1621		13216-1540 13216-1540B	13011-1961	13272-1220 13272-1270	
NM-Motorservice Article no./ Artikelnummer/ Modelo número/ статья номер	NM-Motorservice Article no.:	NM-Motorservice Article no.:	NM-Motorservice Article no.:	NM-Motorservice Article no.:	NM-Motorservice Article no.:	NM-Motorservice Article no.:	
	LBS 11400 FA	LB 11400 F (phosphated)	KBS 11400 A	KB 11400 A	KR 11400	PB 11400	

ENGINE TYPE Motortyp/ tipo de motor/ тип двигателя	LINER KIT Liner Kit/ camisas de los cilindros/ Лайнер комплект	CYL. LINER Zylinderlaufbuchse/ camisas de los cilindros/ втулка цилиндра	PISTON + RINGS Kolben + Ringe/ Pistón + Anillos/ поршень и кольца	PISTON SET Kolben Set/ Pistón Set/ поршневой	RINGS SET Ring Set/ Anillos Set/ кольца	PIN Pin/ Perno/ Пин	
H06CT 6,485 cc 6 cyl 108.0 mm Bore Ø	Liner OD is graded as W X and Y Z	Liner/ Sleeve	Piston		Rings		Ø : 39.0 Length: 90.0
		Length: Outside Ø: Flange Ø: Flange depth:	204.0 113.0 118.0 8.0 +1.0	Length: Comp. height:	121.5 69.5 -16.4 -21.1	Top: 2nd: 3rd: oil:	
	Reference no.:	Reference no.:		Reference no.:	Reference no.:	Reference no.:	
		11467-1591 11467-1601 11467-1611 11467-1621		13216-1750	13011-1961	13272-1220 13272-1270	
NM-Motorservice Article no./ Artikelnummer/ Modelo número/ статья номер	NM-Motorservice Article no.:	NM-Motorservice Article no.:	NM-Motorservice Article no.:	NM-Motorservice Article no.:	NM-Motorservice Article no.:	NM-Motorservice Article no.:	
	LBS 11450 FA	LB 11450 F (phosphated)	KBS 11450 A	KB 11450 A	KR 11450	PB 11450	

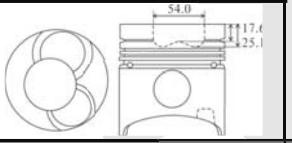
ENGINE TYPE Motortyp/ tipo de motor/ тип двигателя	LINER KIT Liner Kit/ camisas de los cilindros/ Лайнер комплект	CYL. LINER Zylinderlaufbuchse/ camisas de los cilindros/ втулка цилиндра	PISTON + RINGS Kolben + Ringe/ Pistón + Anillos/ поршень и кольца	PISTON SET Kolben Set/ Pistón Set/ поршневой	RINGS SET Ring Set/ Anillos Set/ кольца	PIN Pin/ Perno/ Пин	
H06CT 6,485 cc 6 cyl 108.0 mm Bore Ø	Liner OD is graded as W X and Y Z	Liner/ Sleeve	Piston		Rings		Ø : 39.0 Length: 90.0
		Length: Outside Ø: Flange Ø: Flange depth:	204.0 113.0 118.0 8.0 +1.0	Length: Comp. height:	121.5 69.5 -13.9 -20.3	Top: 2nd: 3rd: oil:	
	Reference no.:	Reference no.:		Reference no.:	Reference no.:	Reference no.:	
		11467-1591 11467-1601 11467-1611 11467-1621			13011-1961	13272-1220 13272-1270	
NM-Motorservice Article no./ Artikelnummer/ Modelo número/ статья номер	NM-Motorservice Article no.:	NM-Motorservice Article no.:	NM-Motorservice Article no.:	NM-Motorservice Article no.:	NM-Motorservice Article no.:	NM-Motorservice Article no.:	
	LBS 38400 FA	LB 38400 F (phosphated)	KBS 38400 A	KB 38400 A	KR 38400	PB 38400	

ENGINE TYPE Motortyp/ tipo de motor/ тип двигателя	LINER KIT Liner Kit/ camisas de los cilindros/ Лайнер комплект	CYL. LINER Zylinderlaufbuchse/ camisas de los cilindros/ втулка цилиндра	PISTON + RINGS Kolben + Ringe/ Pistón + Anillos/ поршень и кольца	PISTON SET Kolben Set/ Pistón Set/ поршневой	RINGS SET Ring Set/ Anillos Set/ кольца	PIN Pin/ Perno/ Пин
H06CT 6,485 cc 6 cyl 108.0 mm Bore Ø	Liner OD is graded as W X and Y Z		Piston		Rings	
		Length: 204.0 Outside Ø: 113.0 Flange Ø: 118.0 Flange depth: 8.0 +1.0	Length: 121.5 Comp. height: 69.5 -18.0 -25.5	Top: 2.8 2nd: 2.5 3rd: 2.5 oil: 5.0	Ø: 39.0 Length: 90.0	
	Reference no.:			Reference no.:	Reference no.:	Reference no.:
	11467-1591 11467-1601 11467-1611 11467-1621			13216-1810 13216-1810A	13011-1961	13272-1220 13272-1270
NM-Motorservice Article no./ Artikelnummer/ Modelo número/ статья номер	NM-Motorservice Article no.:	NM-Motorservice Article no.:	NM-Motorservice Article no.:	NM-Motorservice Article no.:	NM-Motorservice Article no.:	NM-Motorservice Article no.:
	LBS 11550 FA	LB 11550 F (phosphated)	KBS 11550 A	KB 11550 A	KR 11550	PB 11550

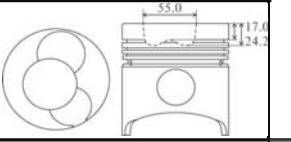

ENGINE TYPE Motortyp/ tipo de motor/ тип двигателя	LINER KIT Liner Kit/ camisas de los cilindros/ Лайнер комплект	CYL. LINER Zylinderlaufbuchse/ camisas de los cilindros/ втулка цилиндра	PISTON + RINGS Kolben + Ringe/ Pistón + Anillos/ поршень и кольца	PISTON SET Kolben Set/ Pistón Set/ поршневой	RINGS SET Ring Set/ Anillos Set/ кольца	PIN Pin/ Perno/ Пин
H06C TA 6,485 cc 6 cyl 108.0 mm Bore Ø	Liner OD is graded as W X and Y Z		Piston		Rings	
		Length: 204.0 Outside Ø: 113.0 Flange Ø: 118.0 Flange depth: 8.0 +1.0	Length: 121.4 Comp. height: 69.3 -17.6 -25.1	Top: 2.8 2nd: 2.5 3rd: 2.5 oil: 5.0	Ø: 39.0 Length: 90.0	
	Reference no.:			Reference no.:	Reference no.:	Reference no.:
	11467-1591 11467-1601 11467-1611 11467-1621			13211-1891	13011-1961	13272-1220 13272-1270
NM-Motorservice Article no./ Artikelnummer/ Modelo número/ статья номер	NM-Motorservice Article no.:	NM-Motorservice Article no.:	NM-Motorservice Article no.:	NM-Motorservice Article no.:	NM-Motorservice Article no.:	NM-Motorservice Article no.:
	LBS 11600 FA	LB 11600 F (phosphated)	KBS 11600 A	KB 11600 A	KR 11600	PB 11600



ENGINE TYPE Motortyp/ tipo de motor/ тип двигателя	LINER KIT Liner Kit/ camisas de los cilindros/ Лайнер комплект	CYL. LINER Zylinderlaufbuchse/ camisas de los cilindros/ втулка цилиндра	PISTON + RINGS Kolben + Ringe/ Pistón + Anillos/ поршень и кольца	PISTON SET Kolben Set/ Pistón Set/ поршневой	RINGS SET Ring Set/ Anillos Set/ кольца	PIN Pin/ Perno/ Пин
EH700 6,443 cc 6 cyl 110.0 mm Bore Ø	Liner OD is graded as W X and Y Z		Piston		Rings	
		Length: 204.0 Outside Ø: 113.0 Flange Ø: 118.0 Flange depth: 8.0 +0.8	Length: 121.5 Comp. height: 69.5 -17.0 -24.2	Top: 3.0 2nd: 2.5 3rd: 2.5 oil: 5.0	Ø: 39.0 Length: 90.0	
	Reference no.:			Reference no.:	Reference no.:	Reference no.:
	11467-1200 11467-1210 11467-1220 11467-1230			13211-1471 13216-1180 13216-1181	13011-1610 13011-1610B 13011-1620 13011-1620A 13011-2070A 13011-2090	13272-1220 13272-1270
NM-Motorservice Article no./ Artikelnummer/ Modelo número/ статья номер	NM-Motorservice Article no.:	NM-Motorservice Article no.:	NM-Motorservice Article no.:	NM-Motorservice Article no.:	NM-Motorservice Article no.:	NM-Motorservice Article no.:
	LBS 11650 FA	LB 11650 F (phosphated)	KBS 11650 A	KB 11650 A	KR 11650	PB 11650

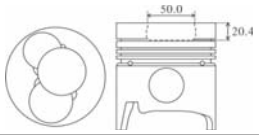

ENGINE TYPE Motortyp/ tipo de motor/ тип двигателя	LINER KIT Liner Kit/ camisas de los cilindros/ Лайнер комплект	CYL. LINER Zylinderlaufbuchse/ camisas de los cilindros/ втулка цилиндра	PISTON + RINGS Kolben + Ringe/ Pistón + Anillos/ поршень и кольца	PISTON SET Kolben Set/ Pistón Set/ поршневой	RINGS SET Ring Set/ Anillos Set/ кольца	PIN Pin/ Perno/ Пин
H07C 6,728 cc 6 cyl 110.0 mm Bore Ø	Liner OD is graded as W X and Y Z					
		Length: 204.0 Outside Ø: 113.0 Flange Ø: 118.0 Flange depth: 8.0 +0.8	Length: 121.6 Comp. height: 69.5 -20.1		Top: 3.0 2nd: 2.5 3rd: 2.5 oil: 5.0	Ø: 39.0 Length: 90.0
		Reference no.:		Reference no.:	Reference no.:	Reference no.:
		11467-1200 11467-1210 11467-1220 11467-1230		13216-1771 13216-2300	13011-1610 13011-1610B 13011-1620 13011-1620A 13011-2070A 13011-2090	13272-1220 13272-1270
	NM-Motorservice Article no.:	NM-Motorservice Article no.:	NM-Motorservice Article no.:	NM-Motorservice Article no.:	NM-Motorservice Article no.:	NM-Motorservice Article no.:
	LBS 11700 FA	LB 11700 F (phosphated)	KBS 11700 A	KB 11700 A	KR 11700	PB 11700

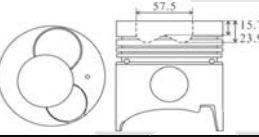

ENGINE TYPE Motortyp/ tipo de motor/ тип двигателя	LINER KIT Liner Kit/ camisas de los cilindros/ Лайнер комплект	CYL. LINER Zylinderlaufbuchse/ camisas de los cilindros/ втулка цилиндра	PISTON + RINGS Kolben + Ringe/ Pistón + Anillos/ поршень и кольца	PISTON SET Kolben Set/ Pistón Set/ поршневой	RINGS SET Ring Set/ Anillos Set/ кольца	PIN Pin/ Perno/ Пин
H07D 7,412 cc 6 cyl 110.0 mm Bore Ø	Liner OD is graded as W X and Y Z					
		Length: 204.00 Outside Ø: 113.0 Flange Ø: 118.0 Flange depth: 8.0 +0.8	Length: 100.00 Comp. height: 57.0 -20.5		Top: 3.0 2nd: 2.0 oil: 4.0	Ø: 37.0 Length: 86.0
		Reference no.:		Reference no.:	Reference no.:	Reference no.:
		11467-1200 11467-1210 11467-1220 11467-1230		13216-2260	13011-2650 13011-2651 13011-2651A 13011-2660	
	NM-Motorservice Article no.:	NM-Motorservice Article no.:	NM-Motorservice Article no.:	NM-Motorservice Article no.:	NM-Motorservice Article no.:	NM-Motorservice Article no.:
	LBS 11750 FA	LB 11750 F (phosphated)	KBS 11750 A	KB 11750 A	KR 11750	PB 11750

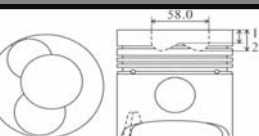

ENGINE TYPE Motortyp/ tipo de motor/ тип двигателя	LINER KIT Liner Kit/ camisas de los cilindros/ Лайнер комплект	CYL. LINER Zylinderlaufbuchse/ camisas de los cilindros/ втулка цилиндра	PISTON + RINGS Kolben + Ringe/ Pistón + Anillos/ поршень и кольца	PISTON SET Kolben Set/ Pistón Set/ поршневой	RINGS SET Ring Set/ Anillos Set/ кольца	PIN Pin/ Perno/ Пин
H07C New 6,728 cc 6 cyl 110.0 mm Bore Ø	Liner OD is graded as W X and Y Z					
		Length: 204.0 Outside Ø: 113.0 Flange Ø: 118.0 Flange depth: 8.0 +0.8	Length: 121.4 Comp. height: 69.4 -20.6 -27.6		Top: 3.0 2nd: 2.5 3rd: 2.5 oil: 5.0	Ø: 39.0 Length: 90.0
		Reference no.:		Reference no.:	Reference no.:	Reference no.:
		11467-1200 11467-1210 11467-1220 11467-1230		13216-1851 13216-2290	13011-1610 13011-1610B 13011-1620 13011-1620A 13011-2070A 13011-2090	13272-1220 13272-1270
	NM-Motorservice Article no.:	NM-Motorservice Article no.:	NM-Motorservice Article no.:	NM-Motorservice Article no.:	NM-Motorservice Article no.:	NM-Motorservice Article no.:
	LBS 11800 FA	LB 11800 F (phosphated)	KBS 11800 A	KB 11800 A	KR 11800	PB 11800

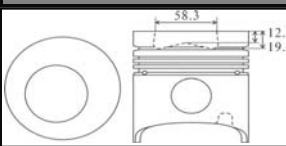

ENGINE TYPE Motortyp/ tipo de motor/ тип двигателя	LINER KIT Liner Kit/ camisas de los cilindros/ Лайнер комплект	CYL. LINER Zylinderlaufbuchse/ camisas de los cilindros/ втулка цилиндра	PISTON + RINGS Kolben + Ringe/ Pistón + Anillos/ поршень и кольца		PISTON SET Kolben Set/ Pistón Set/ поршневой	RINGS SET Ring Set/ Anillos Set/ кольца	PIN Pin/ Perno/ Пин																																			
EH700 New 6,443 cc 6 cyl 110.0 mm Bore Ø	Liner OD is graded as W X and Y Z	<table border="1"> <tr> <td></td> <td>Liner/ Sleeve</td> <td></td> </tr> <tr> <td>Length:</td> <td>204.0</td> <td></td> </tr> <tr> <td>Outside Ø:</td> <td>113.0</td> <td></td> </tr> <tr> <td>Flange Ø:</td> <td>118.0</td> <td></td> </tr> <tr> <td>Flange depth:</td> <td>8.0 +0.8</td> <td></td> </tr> </table>		Liner/ Sleeve		Length:	204.0		Outside Ø:	113.0		Flange Ø:	118.0		Flange depth:	8.0 +0.8		<table border="1"> <tr> <td></td> <td>Piston</td> </tr> <tr> <td>Length:</td> <td>121.5</td> </tr> <tr> <td>Comp. height:</td> <td>69.4 -20.4</td> </tr> </table>			Piston	Length:	121.5	Comp. height:	69.4 -20.4		<table border="1"> <tr> <td colspan="2">Rings</td> </tr> <tr> <td>Top:</td> <td>3.0</td> </tr> <tr> <td>2nd:</td> <td>2.5</td> </tr> <tr> <td>3rd:</td> <td>2.5</td> </tr> <tr> <td>oil:</td> <td>5.0</td> </tr> </table>	Rings		Top:	3.0	2nd:	2.5	3rd:	2.5	oil:	5.0	<table border="1"> <tr> <td>Ø :</td> <td>39.0</td> </tr> <tr> <td>Length:</td> <td>90.0</td> </tr> </table>	Ø :	39.0	Length:	90.0
				Liner/ Sleeve																																						
Length:	204.0																																									
Outside Ø:	113.0																																									
Flange Ø:	118.0																																									
Flange depth:	8.0 +0.8																																									
	Piston																																									
Length:	121.5																																									
Comp. height:	69.4 -20.4																																									
Rings																																										
Top:	3.0																																									
2nd:	2.5																																									
3rd:	2.5																																									
oil:	5.0																																									
Ø :	39.0																																									
Length:	90.0																																									
	Reference no.:	Reference no.:		Reference no.:	Reference no.:	Reference no.:																																				
	11467-1200 11467-1210 11467-1220 11467-1230	13216-1890		13011-1610 13011-1610B 13011-1620 13011-1620A 13011-2070A 13011-2090	13272-1220 13272-1270																																					
NM-Motorservice Article no./ Artikelnummer/ Modelo número/ статья номер	NM-Motorservice Article no.:	NM-Motorservice Article no.:	NM-Motorservice Article no.:	NM-Motorservice Article no.:	NM-Motorservice Article no.:	NM-Motorservice Article no.:																																				
	LBS 11850 FA	LB 11850 F (phosphated)	KBS 11850 A	KB 11850 A	KR 11850	PB 11850																																				

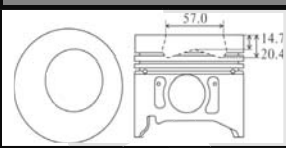

ENGINE TYPE Motortyp/ tipo de motor/ тип двигателя	LINER KIT Liner Kit/ camisas de los cilindros/ Лайнер комплект	CYL. LINER Zylinderlaufbuchse/ camisas de los cilindros/ втулка цилиндра	PISTON + RINGS Kolben + Ringe/ Pistón + Anillos/ поршень и кольца		PISTON SET Kolben Set/ Pistón Set/ поршневой	RINGS SET Ring Set/ Anillos Set/ кольца	PIN Pin/ Perno/ Пин																																			
EH700T 6,443 cc 6 cyl 114.0 mm Bore Ø	Liner OD is graded as W X and Y Z	<table border="1"> <tr> <td></td> <td>Liner/ Sleeve</td> <td></td> </tr> <tr> <td>Length:</td> <td>204.0</td> <td></td> </tr> <tr> <td>Outside Ø:</td> <td>113.0</td> <td></td> </tr> <tr> <td>Flange Ø:</td> <td>118.0</td> <td></td> </tr> <tr> <td>Flange depth:</td> <td>8.0 +0.8</td> <td></td> </tr> </table>		Liner/ Sleeve		Length:	204.0		Outside Ø:	113.0		Flange Ø:	118.0		Flange depth:	8.0 +0.8		<table border="1"> <tr> <td></td> <td>Piston</td> </tr> <tr> <td>Length:</td> <td>121.3</td> </tr> <tr> <td>Comp. height:</td> <td>69.3 -15.7 -23.9</td> </tr> </table>			Piston	Length:	121.3	Comp. height:	69.3 -15.7 -23.9		<table border="1"> <tr> <td colspan="2">Rings</td> </tr> <tr> <td>Top:</td> <td>3.0</td> </tr> <tr> <td>2nd:</td> <td>2.5</td> </tr> <tr> <td>3rd:</td> <td>2.5</td> </tr> <tr> <td>oil:</td> <td>5.0</td> </tr> </table>	Rings		Top:	3.0	2nd:	2.5	3rd:	2.5	oil:	5.0	<table border="1"> <tr> <td>Ø :</td> <td>39.0</td> </tr> <tr> <td>Length:</td> <td>90.0</td> </tr> </table>	Ø :	39.0	Length:	90.0
				Liner/ Sleeve																																						
Length:	204.0																																									
Outside Ø:	113.0																																									
Flange Ø:	118.0																																									
Flange depth:	8.0 +0.8																																									
	Piston																																									
Length:	121.3																																									
Comp. height:	69.3 -15.7 -23.9																																									
Rings																																										
Top:	3.0																																									
2nd:	2.5																																									
3rd:	2.5																																									
oil:	5.0																																									
Ø :	39.0																																									
Length:	90.0																																									
	Reference no.:	Reference no.:		Reference no.:	Reference no.:	Reference no.:																																				
	11467-1200 11467-1210 11467-1220 11467-1230	13211-1740 13216-1380		13011-1610 13011-1610B 13011-1620 13011-1620A 13011-2070A 13011-2090	13272-1220 13272-1270																																					
NM-Motorservice Article no./ Artikelnummer/ Modelo número/ статья номер	NM-Motorservice Article no.:	NM-Motorservice Article no.:	NM-Motorservice Article no.:	NM-Motorservice Article no.:	NM-Motorservice Article no.:	NM-Motorservice Article no.:																																				
	LBS 11900 FA	LB 11900 F (phosphated)	KBS 11900 A	KB 11900 A	KR 11900	PB 11900																																				

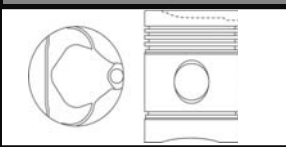

ENGINE TYPE Motortyp/ tipo de motor/ тип двигателя	LINER KIT Liner Kit/ camisas de los cilindros/ Лайнер комплект	CYL. LINER Zylinderlaufbuchse/ camisas de los cilindros/ втулка цилиндра	PISTON + RINGS Kolben + Ringe/ Pistón + Anillos/ поршень и кольца		PISTON SET Kolben Set/ Pistón Set/ поршневой	RINGS SET Ring Set/ Anillos Set/ кольца	PIN Pin/ Perno/ Пин																																			
EH700T New 6,443 cc 6 cyl 110.0 mm Bore Ø	Liner OD is graded as W X and Y Z	<table border="1"> <tr> <td></td> <td>Liner/ Sleeve</td> <td></td> </tr> <tr> <td>Length:</td> <td>204.0</td> <td></td> </tr> <tr> <td>Outside Ø:</td> <td>113.0</td> <td></td> </tr> <tr> <td>Flange Ø:</td> <td>118.0</td> <td></td> </tr> <tr> <td>Flange depth:</td> <td>8.0 +0.8</td> <td></td> </tr> </table>		Liner/ Sleeve		Length:	204.0		Outside Ø:	113.0		Flange Ø:	118.0		Flange depth:	8.0 +0.8		<table border="1"> <tr> <td></td> <td>Piston</td> </tr> <tr> <td>Length:</td> <td>121.3</td> </tr> <tr> <td>Comp. height:</td> <td>69.3 -14.9 -23.6</td> </tr> </table>			Piston	Length:	121.3	Comp. height:	69.3 -14.9 -23.6		<table border="1"> <tr> <td colspan="2">Rings</td> </tr> <tr> <td>Top:</td> <td>3.0</td> </tr> <tr> <td>2nd:</td> <td>2.5</td> </tr> <tr> <td>3rd:</td> <td>2.5</td> </tr> <tr> <td>oil:</td> <td>5.0</td> </tr> </table>	Rings		Top:	3.0	2nd:	2.5	3rd:	2.5	oil:	5.0	<table border="1"> <tr> <td>Ø :</td> <td>39.0</td> </tr> <tr> <td>Length:</td> <td>90.0</td> </tr> </table>	Ø :	39.0	Length:	90.0
				Liner/ Sleeve																																						
Length:	204.0																																									
Outside Ø:	113.0																																									
Flange Ø:	118.0																																									
Flange depth:	8.0 +0.8																																									
	Piston																																									
Length:	121.3																																									
Comp. height:	69.3 -14.9 -23.6																																									
Rings																																										
Top:	3.0																																									
2nd:	2.5																																									
3rd:	2.5																																									
oil:	5.0																																									
Ø :	39.0																																									
Length:	90.0																																									
	Reference no.:	Reference no.:		Reference no.:	Reference no.:	Reference no.:																																				
	11467-1200 11467-1210 11467-1220 11467-1230	13216-1390		13011-1610 13011-1610B 13011-1620 13011-1620A 13011-2070A 13011-2090	13272-1220 13272-1270																																					
NM-Motorservice Article no./ Artikelnummer/ Modelo número/ статья номер	NM-Motorservice Article no.:	NM-Motorservice Article no.:	NM-Motorservice Article no.:	NM-Motorservice Article no.:	NM-Motorservice Article no.:	NM-Motorservice Article no.:																																				
	LBS 11950 FA	LB 11950 F (phosphated)	KBS 11950 A	KB 11950 A	KR 11950	PB 11950																																				

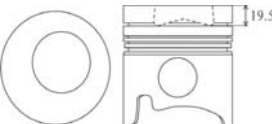

ENGINE TYPE Motortyp/ tipo de motor/ тип двигателя	LINER KIT Liner Kit/ camisas de los cilindros/ Лайнер комплект	CYL. LINER Zylinderlaufbuchse/ camisas de los cilindros/ втулка цилиндра	PISTON + RINGS Kolben + Ringe/ Pistón + Anillos/ поршень и кольца	PISTON SET Kolben Set/ Pistón Set/ поршневой	RINGS SET Ring Set/ Anillos Set/ кольца	PIN Pin/ Perno/ Пин
H07CT 6,728 cc 6 cyl 110.0 mm Bore Ø	Liner OD is graded as W X and Y Z			Alfin and with oil gallery	Rings	Ø : 39.0 Length: 90.0
			Liner/ Sleeve			
		Length: 204.0 Outside Ø: 113.0 Flange Ø: 118.0 Flange depth: 8.0 +0.8	Length: 121.4 Comp. height: 69.4 -12.7 -19.4			
		Reference no.:		Reference no.:	Reference no.:	Reference no.:
		11467-1200 11467-1210 11467-1220 11467-1230		13216-2062	13011-2672 13011-2672A	13272-1220 13272-1270
NM-Motorservice Article no./ Artikelnummer/ Modelo número/ статья номер	NM-Motorservice Article no.:	NM-Motorservice Article no.:	NM-Motorservice Article no.:	NM-Motorservice Article no.:	NM-Motorservice Article no.:	NM-Motorservice Article no.:
	LBS 35150 FB	LB 35150 F (phosphated)	KBS 35150 B	KB 35150 B	KR 35150	PB 35150

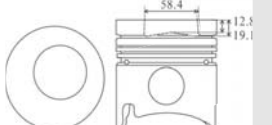

ENGINE TYPE Motortyp/ tipo de motor/ тип двигателя	LINER KIT Liner Kit/ camisas de los cilindros/ Лайнер комплект	CYL. LINER Zylinderlaufbuchse/ camisas de los cilindros/ втулка цилиндра	PISTON + RINGS Kolben + Ringe/ Pistón + Anillos/ поршень и кольца	PISTON SET Kolben Set/ Pistón Set/ поршневой	RINGS SET Ring Set/ Anillos Set/ кольца	PIN Pin/ Perno/ Пин
H07DT 7,412 cc 6 cyl 110.0 mm Bore Ø	Liner OD is graded as W X and Y Z				Rings	Ø : 37.0 Length: 84.5
			Liner/ Sleeve			
		Length: 204.00 Outside Ø: 113.0 Flange Ø: 118.0 Flange depth: 8.0 +0.8	Length: 100.00 Comp. height: 57.0 -14.7 -20.4			
		Reference no.:		Reference no.:	Reference no.:	Reference no.:
		11467-1200 11467-1210 11467-1220 11467-1230		13216-1980	13011-2650 13011-2651 13011-2651A 13011-2660	13271-1420 13272-1300B 13272-1381
NM-Motorservice Article no./ Artikelnummer/ Modelo número/ статья номер	NM-Motorservice Article no.:	NM-Motorservice Article no.:	NM-Motorservice Article no.:	NM-Motorservice Article no.:	NM-Motorservice Article no.:	NM-Motorservice Article no.:
	LBS 35200 FA	LB 35200 F (phosphated)	KBS 35200 A	KB 35200 A	KR 35200	PB 35200

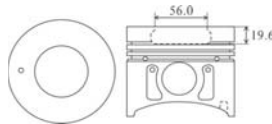

ENGINE TYPE Motortyp/ tipo de motor/ тип двигателя	LINER KIT Liner Kit/ camisas de los cilindros/ Лайнер комплект	CYL. LINER Zylinderlaufbuchse/ camisas de los cilindros/ втулка цилиндра	PISTON + RINGS Kolben + Ringe/ Pistón + Anillos/ поршень и кольца	PISTON SET Kolben Set/ Pistón Set/ поршневой	RINGS SET Ring Set/ Anillos Set/ кольца	PIN Pin/ Perno/ Пин
DS50/ DS80 7,982 cc 6 cyl 110.0 mm Bore Ø					Rings	Ø : 40.0 Length: 92.0
			Liner/ Sleeve			
		Length: 266.0 Outside Ø: 124.5 Flange Ø: 131.0 Flange depth: 10.0 +1.0	Length: 145.5 Comp. height: 78.8 -2.3			
		Reference no.:		Reference no.:	Reference no.:	Reference no.:
		11467-1550 11467-1550B		13216-1050 13216-1050B	13011-1230 13011-1250 13011-1261 13011-1650 13011-1680 13011-1830	13272-1070 13272-1180
NM-Motorservice Article no./ Artikelnummer/ Modelo número/ статья номер	NM-Motorservice Article no.:	NM-Motorservice Article no.:	NM-Motorservice Article no.:	NM-Motorservice Article no.:	NM-Motorservice Article no.:	NM-Motorservice Article no.:
	LBS 12100 AF	LB 12100 F	KBS 12100 A	KB 12100 A	KR 12100	PB 12100

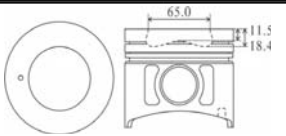

ENGINE TYPE Motortyp/ tipo de motor/ тип двигателя	LINER KIT Liner Kit/ camisas de los cilindros/ Лайнер комплект	CYL. LINER Zylinderlaufbuchse/ camisas de los cilindros/ втулка цилиндра	PISTON + RINGS Kolben + Ringe/ Pistón + Anillos/ поршень и кольца	PISTON SET Kolben Set/ Pistón Set/ поршневой	RINGS SET Ring Set/ Anillos Set/ кольца	PIN Pin/ Perno/ Пин
H07CT New 6,728 cc 6 cyl 110.0 mm Bore Ø	Liner OD is graded as W X and Y Z		Piston	Alfin and with oil gallery	Rings	
		Length: 204.0 Outside Ø: 113.0 Flange Ø: 118.0 Flange depth: 8.0 +1.0	Length: 121.5 Comp. height: 69.5 -19.5		Top: 2.8 2nd: 2.0 3rd: 2.0 oil: 4.0	Ø: 39.0 Length: 90.0
		Reference no.:		Reference no.:	Reference no.:	Reference no.:
		11467-1200 11467-1210 11467-1220 11467-1230		13216-2740	13011-3510 13011-3510A	13272-1220 13272-1270
NM-Motorservice Article no./ Artikelnummer/ Modelo número/ статья номер	NM-Motorservice Article no.:	NM-Motorservice Article no.:	NM-Motorservice Article no.:	NM-Motorservice Article no.:	NM-Motorservice Article no.:	NM-Motorservice Article no.:
	LBS 12150 FB	LB 12150 F (phosphated)	KBS 12150 B	KB 12150 B	KR 12150	PB 12150

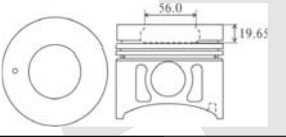

ENGINE TYPE Motortyp/ tipo de motor/ тип двигателя	LINER KIT Liner Kit/ camisas de los cilindros/ Лайнер комплект	CYL. LINER Zylinderlaufbuchse/ camisas de los cilindros/ втулка цилиндра	PISTON + RINGS Kolben + Ringe/ Pistón + Anillos/ поршень и кольца	PISTON SET Kolben Set/ Pistón Set/ поршневой	RINGS SET Ring Set/ Anillos Set/ кольца	PIN Pin/ Perno/ Пин
H07CA New 6,728 cc 6 cyl 110.0 mm Bore Ø	Liner OD is graded as W X and Y Z		Piston	Alfin and with oil gallery	Rings	
		Length: 204.0 Outside Ø: 113.0 Flange Ø: 118.0 Flange depth: 8.0 +1.0	Length: 121.4 Comp. height: 69.3 -17.6 -25.1		Top: 2.8 2nd: 2.5 3rd: 2.5 oil: 5.0	Ø: 39.0 Length: 90.0
		Reference no.:		Reference no.:	Reference no.:	Reference no.:
		11467-1200 11467-1210 11467-1220 11467-1230		13216-2152	13011-2672 13011-2672A	13272-1220 13272-1270
NM-Motorservice Article no./ Artikelnummer/ Modelo número/ статья номер	NM-Motorservice Article no.:	NM-Motorservice Article no.:	NM-Motorservice Article no.:	NM-Motorservice Article no.:	NM-Motorservice Article no.:	NM-Motorservice Article no.:
	LBS 12200 FB	LB 12200 F (phosphated)	KBS 12200 B	KB 12200 B	KR 12200	PB 12200

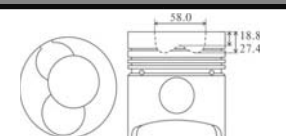

ENGINE TYPE Motortyp/ tipo de motor/ тип двигателя	LINER KIT Liner Kit/ camisas de los cilindros/ Лайнер комплект	CYL. LINER Zylinderlaufbuchse/ camisas de los cilindros/ втулка цилиндра	PISTON + RINGS Kolben + Ringe/ Pistón + Anillos/ поршень и кольца	PISTON SET Kolben Set/ Pistón Set/ поршневой	RINGS SET Ring Set/ Anillos Set/ кольца	PIN Pin/ Perno/ Пин
J08C 7,961 cc 6 cyl 114.0 mm Bore Ø	Liner OD is graded as A, B and C		Piston		Rings	
		Length: 204.0 Outside Ø: 117.0 Flange Ø: 122.0 Flange depth: 8.0 +0.8	Length: 100.0 Comp. height: 57.1 -4.2 -19.6		Top: 3.0 2nd: 2.0 oil: 4.0	Ø: 37.0 Length: 84.5
		Reference no.:		Reference no.:	Reference no.:	Reference no.:
		11461-78060/70/80 11467-2601/11/21 11467-2780/90/800		13216-2631	13011-2960A 13011-2961A 13011-2962 13011-2962A	13271-1420 13272-1300B 13272-1381
NM-Motorservice Article no./ Artikelnummer/ Modelo número/ статья номер	NM-Motorservice Article no.:	NM-Motorservice Article no.:	NM-Motorservice Article no.:	NM-Motorservice Article no.:	NM-Motorservice Article no.:	NM-Motorservice Article no.:
	LBS 12250 FA	LB 12250 F (phosphated)	KBS 12250 A	KB 12250 A	KR 12250	PB 12250

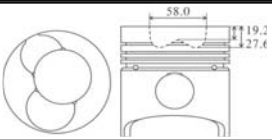

ENGINE TYPE Motortyp/ tipo de motor/ тип двигателя	LINER KIT Liner Kit/ camisas de los cilindros/ Лайнер комплект	CYL. LINER Zylinderlaufbuchse/ camisas de los cilindros/ втулка цилиндра	PISTON + RINGS Kolben + Ringe/ Pistón + Anillos/ поршень и кольца	PISTON SET Kolben Set/ Pistón Set/ поршневой	RINGS SET Ring Set/ Anillos Set/ кольца	PIN Pin/ Perno/ Пин		
J08CT 7,961 cc 6 cyl 114.0 mm Bore Ø	Liner OD is graded as A, B and C	Liner/ Sleeve	Piston		Alfin and with oil gallery pin bushing inserted	Rings		Ø : 37.0 Length: 85.0
		Length: Outside Ø: Flange Ø: Flange depth:	204.0 117.0 122.0 8.0 +0.8	Length: Comp. height:		100.0 57.0 -11.5 -18.4	Top: 2nd: oil:	
		Reference no.:		Reference no.:	Reference no.:	Reference no.:		
		11461-78060/70/80 11467-2601/11/21 11467-2780/90/800		13306-1080	13011-3570 13011-3570A 13011-3820 13011-3820A 13011-3870 13011-3870A	13271-1420 13272-1300B 13272-1381		
NM-Motorservice Article no./ Artikelnummer/ Modelo número/ статья номер	NM-Motorservice Article no.:	NM-Motorservice Article no.:	NM-Motorservice Article no.:	NM-Motorservice Article no.:	NM-Motorservice Article no.:	NM-Motorservice Article no.:		
	LBS 12300 FB	LB 12300 F (phosphated)	KBS 12300 B	KB 12300 B	KR 12300	PB 12300		

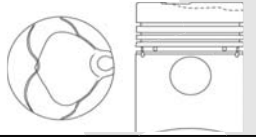

ENGINE TYPE Motortyp/ tipo de motor/ тип двигателя	LINER KIT Liner Kit/ camisas de los cilindros/ Лайнер комплект	CYL. LINER Zylinderlaufbuchse/ camisas de los cilindros/ втулка цилиндра	PISTON + RINGS Kolben + Ringe/ Pistón + Anillos/ поршень и кольца	PISTON SET Kolben Set/ Pistón Set/ поршневой	RINGS SET Ring Set/ Anillos Set/ кольца	PIN Pin/ Perno/ Пин		
J08C 7,961 cc 6 cyl 114.0 mm Bore Ø		Liner/ Sleeve	Piston			Rings		Ø : 37.0 Length: 85.0
		Length: Outside Ø: Flange Ø: Flange depth:	204.0 117.0 122.0 8.0	Length: Comp. height:		100.0 57.0 -19.65	Top: 2nd: oil:	
		Reference no.:		Reference no.:	13011-3570 13011-3570A 13011-3820 13011-3820A 13011-3870 13011-3870A	Reference no.:		
				13216-3211 S1321-63211	13271-1420 13272-1300B 13272-1381			
NM-Motorservice Article no./ Artikelnummer/ Modelo número/ статья номер	NM-Motorservice Article no.:	NM-Motorservice Article no.:	NM-Motorservice Article no.:	NM-Motorservice Article no.:	NM-Motorservice Article no.:	NM-Motorservice Article no.:		
	LBS 12350 FA	LB 12350 F (phosphated)	KBS 12350 A	KB 12350 A	KR 12350	PB 12350		

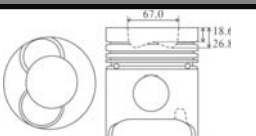

ENGINE TYPE Motortyp/ tipo de motor/ тип двигателя	LINER KIT Liner Kit/ camisas de los cilindros/ Лайнер комплект	CYL. LINER Zylinderlaufbuchse/ camisas de los cilindros/ втулка цилиндра	PISTON + RINGS Kolben + Ringe/ Pistón + Anillos/ поршень и кольца	PISTON SET Kolben Set/ Pistón Set/ поршневой	RINGS SET Ring Set/ Anillos Set/ кольца	PIN Pin/ Perno/ Пин		
EL100 7,862 cc 6 cyl 116.0 mm Bore Ø		Liner/ Sleeve	Piston			Rings		Ø : 40.0 Length: 93.0
		Length: Outside Ø: Flange Ø: Flange depth:	222.8 129.0 138.0 9.0+ 0.75	Length: Comp. height:		130.0 78.2 -18.8 -27.4	Top: 2nd: 3rd: oil:	
		Reference no.:		Reference no.:	Reference no.:	Reference no.:		
		11467-1240 11467-1270 11467-1640	13216-1272A		13011-1700 13011-1700B 13011-1710	13272-1200		
NM-Motorservice Article no./ Artikelnummer/ Modelo número/ статья номер	NM-Motorservice Article no.:	NM-Motorservice Article no.:	NM-Motorservice Article no.:	NM-Motorservice Article no.:	NM-Motorservice Article no.:	NM-Motorservice Article no.:		
	LBS 12400 FA	LB 12400 F	KBS 12400 A	KB 12400 A	KR 12400	PB 12400		

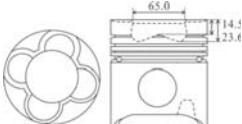

ENGINE TYPE Motortyp/ tipo de motor/ тип двигателя	LINER KIT Liner Kit/ camisas de los cilindros/ Лайнер комплект	CYL. LINER Zylinderlaufbuchse/ camisas de los cilindros/ втулка цилиндра	PISTON + RINGS Kolben + Ringe/ Pistón + Anillos/ поршень и кольца	PISTON SET Kolben Set/ Pistón Set/ поршневой	RINGS SET Ring Set/ Anillos Set/ кольца	PIN Pin/ Perno/ Пин	
EL100 7,862 cc 6 cyl 116.0 mm Bore Ø		Liner/ Sleeve	Piston		Rings		
		Length: Outside Ø: Flange Ø: Flange depth:	222.8 129.0 138.0 9.0 +0.75	Length: Comp. height:	130.5 78.4 -19.2 -27.6	Top: 2nd: 3rd: oil:	3.0 2.5 2.5 5.5
		Reference no.:	Reference no.:		Reference no.:	Reference no.:	
		11467-1240 11467-1270 11467-1640	13306-1080		13011-1700 13011-1700B 13011-1710	13272-1200	
NM-Motorservice Article no./ Artikelnummer/ Modelo número/ статья номер	NM-Motorservice Article no.:	NM-Motorservice Article no.:	NM-Motorservice Article no.:	NM-Motorservice Article no.:	NM-Motorservice Article no.:	NM-Motorservice Article no.:	
	LBS 12450 FA	LB 12450 F	KBS 12450 A	KB 12450 A	KR 12450	PB 12450	

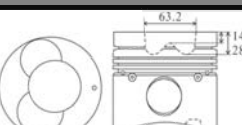

ENGINE TYPE Motortyp/ tipo de motor/ тип двигателя	LINER KIT Liner Kit/ camisas de los cilindros/ Лайнер комплект	CYL. LINER Zylinderlaufbuchse/ camisas de los cilindros/ втулка цилиндра	PISTON + RINGS Kolben + Ringe/ Pistón + Anillos/ поршень и кольца	PISTON SET Kolben Set/ Pistón Set/ поршневой	RINGS SET Ring Set/ Anillos Set/ кольца	PIN Pin/ Perno/ Пин	
EB300 9,838 cc 6 cyl 120.0 mm Bore Ø		Liner/ Sleeve	Piston		Rings		
		Length: Outside Ø: Flange Ø: Flange depth:	288.0 136.0 143.0 11.0 +1.0	Length: Comp. height:	155.4 86.4 -6.0 -10.0	Top: 2nd: 3rd: oil:	3.5 3.5 3.5 6.0
		Reference no.:	Reference no.:	Reference no.:	Reference no.:	Reference no.:	
		11467-1180 11467-1520 2334-1963-00	O-Ring: 11471-1110	13216-1110 13216-1110A 2334-1961-00	13011-1330 13011-1720 13011-1730 13011-1730A	13272-1100	
NM-Motorservice Article no./ Artikelnummer/ Modelo número/ статья номер	NM-Motorservice Article no.:	NM-Motorservice Article no.:	NM-Motorservice Article no.:	NM-Motorservice Article no.:	NM-Motorservice Article no.:	NM-Motorservice Article no.:	
	LBS 12500 F	LB 12500 F	KBS 12500	KB 12500	KR 12500	PB 12500	

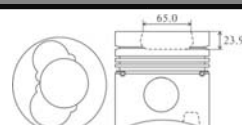

ENGINE TYPE Motortyp/ tipo de motor/ тип двигателя	LINER KIT Liner Kit/ camisas de los cilindros/ Лайнер комплект	CYL. LINER Zylinderlaufbuchse/ camisas de los cilindros/ втулка цилиндра	PISTON + RINGS Kolben + Ringe/ Pistón + Anillos/ поршень и кольца	PISTON SET Kolben Set/ Pistón Set/ поршневой	RINGS SET Ring Set/ Anillos Set/ кольца	PIN Pin/ Perno/ Пин	
EP100T 8,821 cc 6 cyl 120.0 mm Bore Ø		Liner/ Sleeve	Piston		Alfin and with oil gallery	Rings	
		Length: Outside Ø: Flange Ø: Flange depth:	236.0 125.0 132.0 8.0 +1.0	Length: Comp. height:		144.6 85.6 -18.6 -26.8	Top: 2nd: 3rd: oil:
		Reference no.:	Reference no.:		Reference no.:	Reference no.:	Reference no.:
		11467-1730 11467-1740 11467-1750			13216-1450C	13011-1952 13011-2670	13272-1260
NM-Motorservice Article no./ Artikelnummer/ Modelo número/ статья номер	NM-Motorservice Article no.:	NM-Motorservice Article no.:	NM-Motorservice Article no.:	NM-Motorservice Article no.:	NM-Motorservice Article no.:	NM-Motorservice Article no.:	
	LBS 12550 FB	LB 12550 F (phosphated)	KBS 12550 B	KB 12550 B	KR 12550	PB 12550	

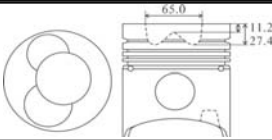

ENGINE TYPE Motortyp/ tipo de motor/ тип двигателя	LINER KIT Liner Kit/ camisas de los cilindros/ Лайнер комплект	CYL. LINER Zylinderlaufbuchse/ camisas de los cilindros/ втулка цилиндра	PISTON + RINGS Kolben + Ringe/ Pistón + Anillos/ поршень и кольца	PISTON SET Kolben Set/ Pistón Set/ поршневой	RINGS SET Ring Set/ Anillos Set/ кольца	PIN Pin/ Perno/ Пин		
EP100/ P09C 8,821 cc 6 cyl 120.0 mm Bore Ø		Liner/ Sleeve	Piston		Alfin and with oil gallery	Rings		Ø : 47.0 Length: 99.0
		Length: 236.0 Outside Ø: 125.0 Flange Ø: 132.0 Flange depth: 8.0 +1.0	Length: 144.6 Comp. height: 85.6 -14.5 -23.6	Top: 3.3 2nd: 3.0 3rd: 2.5 oil: 5.0				
		Reference no.:		Reference no.:	Reference no.:	Reference no.:		
		11467-1730 11467-1740 11467-1750		13216-2460	13011-2370 13011-2370A 13011-2760B 13019-1490A	13272-1260		
NM-Motorservice Article no./ Artikelnummer/ Modelo número/ статья номер	NM-Motorservice Article no.:	NM-Motorservice Article no.:	NM-Motorservice Article no.:	NM-Motorservice Article no.:	NM-Motorservice Article no.:	NM-Motorservice Article no.:		
	LBS 12600 FB	LB 12600 F (phosphated)	KBS 12600 B	KB 12600 B	KR 12600	PB 12600		

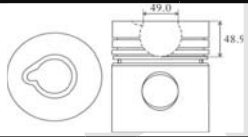

ENGINE TYPE Motortyp/ tipo de motor/ тип двигателя	LINER KIT Liner Kit/ camisas de los cilindros/ Лайнер комплект	CYL. LINER Zylinderlaufbuchse/ camisas de los cilindros/ втулка цилиндра	PISTON + RINGS Kolben + Ringe/ Pistón + Anillos/ поршень и кольца	PISTON SET Kolben Set/ Pistón Set/ поршневой	RINGS SET Ring Set/ Anillos Set/ кольца	PIN Pin/ Perno/ Пин		
EM100 9,419 cc 6 cyl 124.0 mm Bore Ø	Liner OD is graded as A and B	Liner/ Sleeve	Piston			Rings		Ø : 42.0 Length: 98.0
		Length: 236.0 Outside Ø: 129.1 Flange Ø: 134.0 Flange depth: 8.0 +1.2	Length: 139.4 Comp. height: 80.4 -14.4 -28.1	Top: 2.8 2nd: 2.5 3rd: 3.0 oil: 5.0				
		Reference no.:		Reference no.:	Reference no.:	Reference no.:		
		11467-1661 11467-1671		13216-1370	13011-1921 13011-1931 13011-3530	13272-1250		
NM-Motorservice Article no./ Artikelnummer/ Modelo número/ статья номер	NM-Motorservice Article no.:	NM-Motorservice Article no.:	NM-Motorservice Article no.:	NM-Motorservice Article no.:	NM-Motorservice Article no.:	NM-Motorservice Article no.:		
	LBS 12650 FA	LB 12650 F (phosphated)	KBS 12650 A	KB 12650 A	KR 12650	PB 12650		

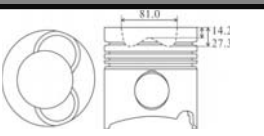

ENGINE TYPE Motortyp/ tipo de motor/ тип двигателя	LINER KIT Liner Kit/ camisas de los cilindros/ Лайнер комплект	CYL. LINER Zylinderlaufbuchse/ camisas de los cilindros/ втулка цилиндра	PISTON + RINGS Kolben + Ringe/ Pistón + Anillos/ поршень и кольца	PISTON SET Kolben Set/ Pistón Set/ поршневой	RINGS SET Ring Set/ Anillos Set/ кольца	PIN Pin/ Perno/ Пин		
M10C 9,880 cc 6 cyl 127.0 mm Bore Ø	Liner OD is graded as W X and Y Z	Liner/ Sleeve	Piston			Rings		Ø : 47.0 Length: 99.0
		Length: 236.0 Outside Ø: 130.3 Flange Ø: 135.2 Flange depth: 8.0 +0.9	Length: 144.5 Comp. height: 85.5 -23.9	Top: 3.3 2nd: 3.0 3rd: 3.0 oil: 5.0				
		Reference no.:		Reference no.:	Reference no.:	Reference no.:		
		11467-2000 11467-2010 11467-2020 11467-2030		13216-2411	13011-2250 13011-2250A 13011-2870	13272-1260		
NM-Motorservice Article no./ Artikelnummer/ Modelo número/ статья номер	NM-Motorservice Article no.:	NM-Motorservice Article no.:	NM-Motorservice Article no.:	NM-Motorservice Article no.:	NM-Motorservice Article no.:	NM-Motorservice Article no.:		
	LBS 12700 FA	LB 12700 F (phosphated)	KBS 12700 A	KB 12700 A	KR 12700	PB 12700		

ENGINE TYPE Motortyp/ tipo de motor/ тип двигателя	LINER KIT Liner Kit/ camisas de los cilindros/ Лайнер комплект	CYL. LINER Zylinderlaufbuchse/ camisas de los cilindros/ втулка цилиндра	PISTON + RINGS Kolben + Ringe/ Pistón + Anillos/ поршень и кольца	PISTON SET Kolben Set/ Pistón Set/ поршневой	RINGS SET Ring Set/ Anillos Set/ кольца	PIN Pin/ Perno/ Пин
M10U 9,880 cc 6 cyl 127.0 mm Bore Ø	Liner OD is graded as W X and Y Z		Piston		Rings	
		Length: 236.0 Outside Ø: 130.3 Flange Ø: 135.2 Flange depth: 8.0 +0.9	Length: 144.5 Comp. height: 85.4 -11.2 -27.4	Top: 3.3 2nd: 3.0 3rd: 3.0 oil: 5.0	Ø: 47.0 Length: 99.0	
		Reference no.:		Reference no.:	Reference no.:	Reference no.:
		11467-2000 11467-2010 11467-2020 11467-2030			13011-2250 13011-2250A 13011-2870	13272-1260
NM-Motorservice Article no./ Artikelnummer/ Modelo número/ статья номер	NM-Motorservice Article no.:	NM-Motorservice Article no.:	NM-Motorservice Article no.:	NM-Motorservice Article no.:	NM-Motorservice Article no.:	NM-Motorservice Article no.:
	LBS 12750 FA	LB 12750 F (phosphated)	KBS 12750 A	KB 12750 A	KR 12750	PB 12750

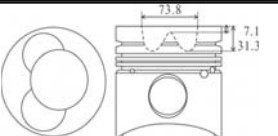
ENGINE TYPE Motortyp/ tipo de motor/ тип двигателя	LINER KIT Liner Kit/ camisas de los cilindros/ Лайнер комплект	CYL. LINER Zylinderlaufbuchse/ camisas de los cilindros/ втулка цилиндра	PISTON + RINGS Kolben + Ringe/ Pistón + Anillos/ поршень и кольца	PISTON SET Kolben Set/ Pistón Set/ поршневой	RINGS SET Ring Set/ Anillos Set/ кольца	PIN Pin/ Perno/ Пин
ED100 11,581 cc 6 cyl 128.0 mm Bore Ø			Piston		Rings	
		Length: 291.0 Outside Ø: 144.0 Flange Ø: 151.0 Flange depth: 11.1 +0.8	Length: 160.0 Comp. height: 99.0 -17.5 -48.9	Top: 3.5 2nd: 3.5 3rd: 3.5 oil: 6.0	Ø: 45.0 Length: 100.0	
		Reference no.:	Reference no.:	Reference no.:	Reference no.:	Reference no.:
		11467-1370	O-Ring: 11471-1040 11471-1180	13216-1170	13011-1470 13011-1480 13011-1660 13011-1670 13011-1670A 13011-2240 3400-1205-09	13272-1080 13272-1150 13272-1190
NM-Motorservice Article no./ Artikelnummer/ Modelo número/ статья номер	NM-Motorservice Article no.:	NM-Motorservice Article no.:	NM-Motorservice Article no.:	NM-Motorservice Article no.:	NM-Motorservice Article no.:	NM-Motorservice Article no.:
	LBS 12800 F LBS 12800 FA	LB 12800 F	KBS 12800 KBS 12800 A	KB 12800 KB 12800 A	KR 12800	PB 12800

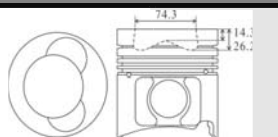

ENGINE TYPE Motortyp/ tipo de motor/ тип двигателя	LINER KIT Liner Kit/ camisas de los cilindros/ Лайнер комплект	CYL. LINER Zylinderlaufbuchse/ camisas de los cilindros/ втулка цилиндра	PISTON + RINGS Kolben + Ringe/ Pistón + Anillos/ поршень и кольца	PISTON SET Kolben Set/ Pistón Set/ поршневой	RINGS SET Ring Set/ Anillos Set/ кольца	PIN Pin/ Perno/ Пин
K13C 12,882 cc 6 cyl 135.0 mm Bore Ø			Piston	Alfin and with oil gallery	Rings	
		Length: 267.0 Outside Ø: 153.0 Flange Ø: 164.0 Flange depth: 12.1 +0.8	Length: 145.4 Comp. height: 90.3 -14.2 -27.3	Top: 3.3 2nd: 3.5 3rd: 3.5 oil: 5.0	Ø: 50.0 Length: 110.0	
		Reference no.:		Reference no.:	Reference no.:	Reference no.:
		11461-2090 11461-2380		13216-2140	13011-3090A	13272-1320
NM-Motorservice Article no./ Artikelnummer/ Modelo número/ статья номер	NM-Motorservice Article no.:	NM-Motorservice Article no.:	NM-Motorservice Article no.:	NM-Motorservice Article no.:	NM-Motorservice Article no.:	NM-Motorservice Article no.:
	LBS 12850 FB	LB 12850 F (water jacket chromed)	KBS 12850 B	KB 12850 B	KR 12850	PB 12850



ENGINE TYPE Motortyp/ tipo de motor/ тип двигателя	LINER KIT Liner Kit/ camisas de los cilindros/ Лайнер комплект	CYL. LINER Zylinderlaufbuchse/ camisas de los cilindros/ втулка цилиндра	PISTON + RINGS Kolben + Ringe/ Pistón + Anillos/ поршень и кольца	PISTON SET Kolben Set/ Pistón Set/ поршневой	RINGS SET Ring Set/ Anillos Set/ кольца	PIN Pin/ Perno/ Пин	
EK100/ EK200 13,267 cc 6 cyl 137.0 mm Bore Ø		Liner/ Sleeve	Piston		Rings		Ø : 50.0 Length: 110.0
		Length: 267.0 Outside Ø: 153.0 Flange Ø: 164.0 Flange depth: 12.0 +0.8	Length: 145.3 Comp. height: 90.3 -7.1 -31.3	Top: 3.3 2nd: 3.5 3rd: 3.5 oil: 6.0			
		Reference no.:	Reference no.:	Reference no.:	Reference no.:	Reference no.:	
		11467-1080 11467-1910 11467-1920 11467-1960	O-Ring: 11471-1210	13211-1900 13216-1220A 13216-1222 13216-1224 13216-1530 13216-1900	13011-1010 13011-1011 13011-1021 13011-1021B 13011-2210	13272-1010	
NM-Motorservice Article no./ Artikelnummer/ Modelo número/ статья номер	NM-Motorservice Article no.:	NM-Motorservice Article no.:	NM-Motorservice Article no.:	NM-Motorservice Article no.:	NM-Motorservice Article no.:	NM-Motorservice Article no.:	
	LBS 12900 FA	LB 12900 F (water jacked chromed)	KBS 12900 A	KB 12900 A	KR 12900	PB 12900	

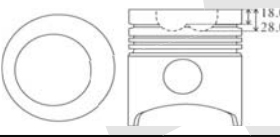

ENGINE TYPE Motortyp/ tipo de motor/ тип двигателя	LINER KIT Liner Kit/ camisas de los cilindros/ Лайнер комплект	CYL. LINER Zylinderlaufbuchse/ camisas de los cilindros/ втулка цилиндра	PISTON + RINGS Kolben + Ringe/ Pistón + Anillos/ поршень и кольца	PISTON SET Kolben Set/ Pistón Set/ поршневой	RINGS SET Ring Set/ Anillos Set/ кольца	PIN Pin/ Perno/ Пин	
K13D 13,267 cc 6 cyl 137.0 mm Bore Ø		Liner/ Sleeve	Piston		Rings		Ø : 50.0 Length: 110.0
		Length: 267.0 Outside Ø: 153.0 Flange Ø: 164.0 Flange depth: 12.0 +0.8	Length: 144.3 Comp. height: 90.3 -14.3 -26.2	Top: 3.3 2nd: 3.5 3rd: 3.5 oil: 5.0			
		Reference no.:	Reference no.:	Reference no.:	Reference no.:	Reference no.:	
		11467-1080 11467-1910 11467-1920 11467-1960	O-Ring: 11471-1210	13216-2100	13011-2770 13011-2771B 13011-2970 13019-1620A	13272-1010	
NM-Motorservice Article no./ Artikelnummer/ Modelo número/ статья номер	NM-Motorservice Article no.:	NM-Motorservice Article no.:	NM-Motorservice Article no.:	NM-Motorservice Article no.:	NM-Motorservice Article no.:	NM-Motorservice Article no.:	
	LBS 12950 FA	LB 12950 F (water jacked chromed)	KBS 12950 A	KB 12950 A	KR 12950	PB 12950	

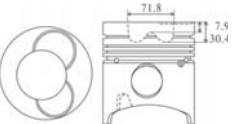

ENGINE TYPE Motortyp/ tipo de motor/ тип двигателя	LINER KIT Liner Kit/ camisas de los cilindros/ Лайнер комплект	CYL. LINER Zylinderlaufbuchse/ camisas de los cilindros/ втулка цилиндра	PISTON + RINGS Kolben + Ringe/ Pistón + Anillos/ поршень и кольца	PISTON SET Kolben Set/ Pistón Set/ поршневой	RINGS SET Ring Set/ Anillos Set/ кольца	PIN Pin/ Perno/ Пин	
K13D 13,267 cc 6 cyl 137.0 mm Bore Ø	Water jacked chromed	Liner/ Sleeve	Piston		Rings		Ø : 50.0 Length: 110.0
		Length: 267.0 Outside Ø: 153.0 Flange Ø: 164.0 Flange depth: 12.0 +0.8	Length: 114.3 Comp. height: 90.3	Top: 3.3 2nd: 3.5 3rd: 3.5 oil: 5.0			
		Reference no.:	Reference no.:	Reference no.:	Reference no.:	Reference no.:	
		11467-1080 11467-1910 11467-1920 11467-1960	O-Ring: 11471-1210	13216-2440 13216-2470	13011-2770 13011-2771B 13011-2970 13019-1620A	13272-1010	
NM-Motorservice Article no./ Artikelnummer/ Modelo número/ статья номер	NM-Motorservice Article no.:	NM-Motorservice Article no.:	NM-Motorservice Article no.:	NM-Motorservice Article no.:	NM-Motorservice Article no.:	NM-Motorservice Article no.:	
	LBS 45300 FA	LB 45300 F (water jacked chromed)	KBS 45300 A	KB 45300 A	KR 45300	PB 45300	



ENGINE TYPE Motortyp/ tipo de motor/ тип двигателя	LINER KIT Liner Kit/ camisas de los cilindros/ Лайнер комплект	CYL. LINER Zylinderlaufbuchse/ camisas de los cilindros/ втулка цилиндра	PISTON + RINGS Kolben + Ringe/ Pistón + Anillos/ поршень и кольца		PISTON SET Kolben Set/ Pistón Set/ поршневой	RINGS SET Ring Set/ Anillos Set/ кольца	PIN Pin/ Perno/ Пин
EK130T 13,546 cc 6 cyl 137.0 mm Bore Ø		Liner/ Sleeve	Piston			Rings	
			Length: Outside Ø: Flange Ø: Flange depth:	267.0 153.0 164.0 12.0 +0.8		Length: Comp. height:	145.3 90.3
		Reference no.:	Reference no.:	Reference no.:	Reference no.:	Reference no.:	
		11467-1080 11467-1910 11467-1920 11467-1960	O-Ring: 11471-1210	13216-1812A 13211-2191	13011-2770 13011-2771B 13011-2970 13019-1620A	13272-1010	
NM-Motorservice Article no./ Artikelnummer/ Modelo número/ статья номер	NM-Motorservice Article no.:	NM-Motorservice Article no.:	NM-Motorservice Article no.:	NM-Motorservice Article no.:	NM-Motorservice Article no.:	NM-Motorservice Article no.:	NM-Motorservice Article no.:
	LBS 44100 FA	LB 44100 F (water jacked chromed)	KBS 44100 A	KB 44100 A	KR 44100	PB 44100	



ENGINE TYPE Motortyp/ tipo de motor/ тип двигателя	LINER KIT Liner Kit/ camisas de los cilindros/ Лайнер комплект	CYL. LINER Zylinderlaufbuchse/ camisas de los cilindros/ втулка цилиндра	PISTON + RINGS Kolben + Ringe/ Pistón + Anillos/ поршень и кольца		PISTON SET Kolben Set/ Pistón Set/ поршневой	RINGS SET Ring Set/ Anillos Set/ кольца	PIN Pin/ Perno/ Пин
EF100 (L/R) 13,804 cc 8 cyl 130.0 mm Bore Ø		Liner/ Sleeve	Piston			Rings	
			Length: Outside Ø: Flange Ø: Flange depth:	248.0 146.0 157.0 12.1 +0.8		Length: Comp. height:	145.0 90.0 -18.0 -28.0
		Reference no.:	Reference no.:	Reference no.:	Reference no.:	Reference no.:	
		11467-1110	O-Ring: 11471-1130	13216-1290 13226-1040 (L/R)	13011-1180/A 13011-1570/A 13011-1580 13011-1590/A 13019-1460A 3391-1205-04	13272-1050	
NM-Motorservice Article no./ Artikelnummer/ Modelo número/ статья номер	NM-Motorservice Article no.:	NM-Motorservice Article no.:	NM-Motorservice Article no.:	NM-Motorservice Article no.:	NM-Motorservice Article no.:	NM-Motorservice Article no.:	NM-Motorservice Article no.:
	LBS 13100 F	LB 13100 F (water jacked chromed)	KBS 13100	KB 13100	KR 13100	PB 13100	



ENGINE TYPE Motortyp/ tipo de motor/ тип двигателя	LINER KIT Liner Kit/ camisas de los cilindros/ Лайнер комплект	CYL. LINER Zylinderlaufbuchse/ camisas de los cilindros/ втулка цилиндра	PISTON + RINGS Kolben + Ringe/ Pistón + Anillos/ поршень и кольца		PISTON SET Kolben Set/ Pistón Set/ поршневой	RINGS SET Ring Set/ Anillos Set/ кольца	PIN Pin/ Perno/ Пин
EF550 (L/R) 16,260 cc 8 cyl 135.0 mm Bore Ø	Water jacked chromed	Liner/ Sleeve	Piston			Rings	
			Length: Outside Ø: Flange Ø: Flange depth:	248.0 153.0 165.0 12.1 +0.8		Length: Comp. height:	145.4 90.3 -7.9 -30.4
		Reference no.:	Reference no.:	Reference no.:	Reference no.:	Reference no.:	
		11467-1690		13226-1140 13216-1560 (L/R)	13011-1131 13011-1131B 13011-1141 13011-1142 13011-1460 13011-2150 13011-2160	13272-1240	
NM-Motorservice Article no./ Artikelnummer/ Modelo número/ статья номер	NM-Motorservice Article no.:	NM-Motorservice Article no.:	NM-Motorservice Article no.:	NM-Motorservice Article no.:	NM-Motorservice Article no.:	NM-Motorservice Article no.:	NM-Motorservice Article no.:
	LBS 13150 FA	LB 13150 F (water jacked chromed)	KBS 13150 A	KB 13150 A	KR 13150	PB 13150	

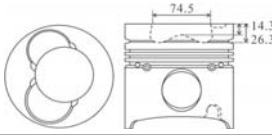

ENGINE TYPE Motortyp/ tipo de motor/ тип двигателя	LINER KIT Liner Kit/ camisas de los cilindros/ Лайнер комплект	CYL. LINER Zylinderlaufbuchse/ camisas de los cilindros/ втулка цилиндра		PISTON + RINGS Kolben + Ringe/ Pistón + Anillos/ поршень и кольца		PISTON SET Kolben Set/ Pistón Set/ поршневой	RINGS SET Ring Set/ Anillos Set/ кольца	PIN Pin/ Perno/ Пин	
EF550 16,260 cc 8 cyl 135.0 mm Bore Ø		Liner/ Sleeve		Piston			Rings		Ø : 50.0 Length: 110.0
		Length: Outside Ø: Flange Ø: Flange depth:	248.0 153.0 165.0 12.1 +0.8		Length: Comp. height:		145.4 90.3 -7.9 -30.4	Top: 2nd: 3rd: oil:	
		Reference no.:				Reference no.:	Reference no.:	Reference no.:	
		11467-1690				13216-2740	13011-2700	13272-1240	
NM-Motorservice Article no./ Artikelnummer/ Modelo número/ статья номер	NM-Motorservice Article no.:	NM-Motorservice Article no.:		NM-Motorservice Article no.:		NM-Motorservice Article no.:	NM-Motorservice Article no.:	NM-Motorservice Article no.:	
	LBS 13200 FA	LB 13200 F (water jacked chromed)		KBS 13200 A		KB 13200 A	KR 13200	PB 13200	

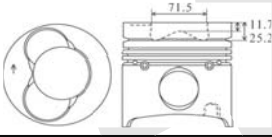

ENGINE TYPE Motortyp/ tipo de motor/ тип двигателя	LINER KIT Liner Kit/ camisas de los cilindros/ Лайнер комплект	CYL. LINER Zylinderlaufbuchse/ camisas de los cilindros/ втулка цилиндра		PISTON + RINGS Kolben + Ringe/ Pistón + Anillos/ поршень и кольца		PISTON SET Kolben Set/ Pistón Set/ поршневой	RINGS SET Ring Set/ Anillos Set/ кольца	PIN Pin/ Perno/ Пин	
EF500 (L/R) 15,459 cc 8 cyl 135.0 mm Bore Ø		Liner/ Sleeve		Piston			Rings		Ø : 50.0 Length: 110.0
		Length: Outside Ø: Flange Ø: Flange depth:	248.0 153.0 165.0 13.6 +0.8		Length: Comp. height:			Top: 2nd: 3rd: oil:	
		Reference no.:				Reference no.:	Reference no.:		Reference no.:
		11467-1101 11467-1120				13216-1252 13226-1022 (L/R)	13011-1131 13011-1131B 13011-1141 13011-1142 13011-1460 13011-2150 13011-2160		
NM-Motorservice Article no./ Artikelnummer/ Modelo número/ статья номер	NM-Motorservice Article no.:	NM-Motorservice Article no.:		NM-Motorservice Article no.:		NM-Motorservice Article no.:	NM-Motorservice Article no.:	NM-Motorservice Article no.:	
	LBS 13250 FA	LB 13250 F (water jacked chromed)		KBS 13250 A		KB 13250 A	KR 13250	PB 13250	

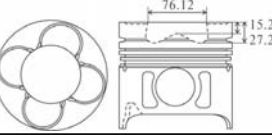

ENGINE TYPE Motortyp/ tipo de motor/ тип двигателя	LINER KIT Liner Kit/ camisas de los cilindros/ Лайнер комплект	CYL. LINER Zylinderlaufbuchse/ camisas de los cilindros/ втулка цилиндра		PISTON + RINGS Kolben + Ringe/ Pistón + Anillos/ поршень и кольца		PISTON SET Kolben Set/ Pistón Set/ поршневой	RINGS SET Ring Set/ Anillos Set/ кольца	PIN Pin/ Perno/ Пин	
EF750 (L/R) 16,745 cc 8 cyl 137.0 mm Bore Ø		Liner/ Sleeve		Piston			Rings		Ø : 37.0 Length: 84.5
		Length: Outside Ø: Flange Ø: Flange depth:	248.0 153.0 165.0 12.0 +0.8		Length: Comp. height:		144.3 90.3 -10.7 -30.3	Top: 2nd: 3rd: oil:	
		Reference no.:		Reference no.:		Reference no.:	Reference no.:	Reference no.:	
		11467-1091 11467-1900		O-Ring: 11471-1400 11471-1450		13216-1860 13226-1170 (L/R)	13011-1111 13011-1112 13011-1121 13011-1121B 13011-1122 13011-2180	13272-1240	
NM-Motorservice Article no./ Artikelnummer/ Modelo número/ статья номер	NM-Motorservice Article no.:	NM-Motorservice Article no.:		NM-Motorservice Article no.:		NM-Motorservice Article no.:	NM-Motorservice Article no.:	NM-Motorservice Article no.:	
	LBS 13300 FA	LB 13300 F (water jacked chromed)		KBS 13300 A		KB 13300 A	KR 13300	PB 13300	

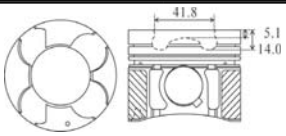

ENGINE TYPE Motor/typo/ tipo de motor/ тип двигателя	LINER KIT Liner Kit/ camisas de los cilindros/ Лайнер комплект	CYL. LINER Zylinderlaufbuchse/ camisas de los cilindros/ втулка цилиндра	PISTON + RINGS Kolben + Ringe/ Pistón + Anillos/ поршень и кольца	PISTON SET Kolben Set/ Pistón Set/ поршневой	RINGS SET Ring Set/ Anillos Set/ кольца	PIN Pin/ Perno/ Пин
F17C (L/R)			Piston		Rings	
17,238 cc 8 cyl 139.0 mm Bore Ø		Length: 248.0 Outside Ø: 154.0 Flange Ø: 166.0 Flange depth: 12.1 +0.8	Length: 144.3 Comp. height: 90.3 -14.3 -26.3		Top: 3.3 2nd: 3.5 3rd: 3.5 oil: 5.0	Ø: 50.0 Length: 110.0
		Reference no.:	Reference no.:	Reference no.:	Reference no.:	Reference no.:
		11467-1702 11467-1702A	O-Ring: 11470-1500 11470-1510 11471-1460	13216-1910 13226-1180 (L/R)	13011-2810 13011-3150 13011-3150A 13011-3160 13019-1700A	13272-1240
NM-Motorservice Article no./ Artikelnummer/ Modelo número/ статья номер	NM-Motorservice Article no.:	NM-Motorservice Article no.:	NM-Motorservice Article no.:	NM-Motorservice Article no.:	NM-Motorservice Article no.:	NM-Motorservice Article no.:
	LBS 13350 FA	LB 13350 F (water jacked chromed)	KBS 13350 A	KB 13350 A	KR 13350	PB 13350

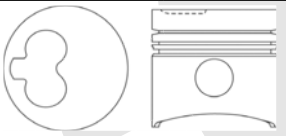

ENGINE TYPE Motor/typo/ tipo de motor/ тип двигателя	LINER KIT Liner Kit/ camisas de los cilindros/ Лайнер комплект	CYL. LINER Zylinderlaufbuchse/ camisas de los cilindros/ втулка цилиндра	PISTON + RINGS Kolben + Ringe/ Pistón + Anillos/ поршень и кольца	PISTON SET Kolben Set/ Pistón Set/ поршневой	RINGS SET Ring Set/ Anillos Set/ кольца	PIN Pin/ Perno/ Пин
F17E (L/R)			Piston		Rings	
17,238 cc 8 cyl 139.0 mm Bore Ø		Length: 248.0 Outside Ø: 154.0 Flange Ø: 166.0 Flange depth: 12.1 +0.8	Length: 144.3 Comp. height: 90.3 -11.7 -25.2		Top: 3.3 2nd: 3.5 3rd: 3.5 oil: 5.0	Ø: 50.0 Length: 110.0
		Reference no.:	Reference no.:	Reference no.:	Reference no.:	Reference no.:
		11467-1702 11467-1702A	O-Ring: 11470-1500 11470-1510 11471-1460	13211-2281 13226-1210 (L/R)	13011-2810 13011-3150 13011-3150A 13011-3160 13019-1700A	13272-1240
NM-Motorservice Article no./ Artikelnummer/ Modelo número/ статья номер	NM-Motorservice Article no.:	NM-Motorservice Article no.:	NM-Motorservice Article no.:	NM-Motorservice Article no.:	NM-Motorservice Article no.:	NM-Motorservice Article no.:
	LBS 13400 FA	LB 13400 F (water jacked chromed)	KBS 13400 A	KB 13400 A	KR 13400	PB 13400

ENGINE TYPE Motor/typo/ tipo de motor/ тип двигателя	LINER KIT Liner Kit/ camisas de los cilindros/ Лайнер комплект	CYL. LINER Zylinderlaufbuchse/ camisas de los cilindros/ втулка цилиндра	PISTON + RINGS Kolben + Ringe/ Pistón + Anillos/ поршень и кольца	PISTON SET Kolben Set/ Pistón Set/ поршневой	RINGS SET Ring Set/ Anillos Set/ кольца	PIN Pin/ Perno/ Пин
F20C (L/R)			Piston		Rings	
19,688 cc 8 cyl 146.0 mm Bore Ø		Length: 224.0 Outside Ø: 152.0 / 154.0 Flange Ø: 159.0 / 160.9 Flange Depth: 8.0 / 8.5 +1.2	Length: 138.4 Comp. height: 84.3 -15.2 -27.2		Top: 3.3 2nd: 3.5 3rd: 3.5 oil: 5.0	Ø: 50.0 Length: 110.0
		Reference no.:		Reference no.:	Reference no.:	Reference no.:
		11467-2280 11467-2290 11467-2300 11467-2690		13211-2502 13216-2671 13221-1242 13226-1321 (L/R)	13011-2792 13011-2792A 13011-3250A 13019-1710A	13272-1240
NM-Motorservice Article no./ Artikelnummer/ Modelo número/ статья номер	NM-Motorservice Article no.:	NM-Motorservice Article no.:	NM-Motorservice Article no.:	NM-Motorservice Article no.:	NM-Motorservice Article no.:	NM-Motorservice Article no.:
	LBS 13450 FA	LB 13450 F (phosphated)	KBS 13450 A	KB 13450 A	KR 13450	PB 13450

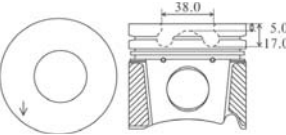

ENGINE TYPE Motortyp/ tipo de motor/ тип двигателя	LINER KIT Liner Kit/ camisas de los cilindros/ Лайнер комплект	CYL. LINER Zylinderlaufbuchse/ camisas de los cilindros/ втулка цилиндра			PISTON + RINGS Kolben + Ringe/ Pistón + Anillos/ поршень и кольца		PISTON SET Kolben Set/ Pistón Set/ поршневой	RINGS SET Ring Set/ Anillos Set/ кольца			PIN Pin/ Perno/ Пин
CIVIC 1.7 CTDi (2002.01-2005) 1,686 cc 4 cyl 79.0 mm Bore Ø			Flanged	No flange	Piston		Alfin and with oil skirt MOS2 treated	Rings			
		Length: Outside Ø: Flange Ø: Flange depth:	144.0 83.0 87.0 2.0	144.0 83.0	Length: Comp. height:	64.7 39.7 -5.1 -14.0		Top: 2nd: oil:	2.0 1.5 3.0	Ø: Length:	27.0 64.0
		Reference no.:					Reference no.:	Reference no.:	Reference no.:		
							13101-PLZ-D00 13102-PLZ-D00 13103-PLZ-D00	13011-PLM-004 13011-PLZ-D00	13232-PLZ-D00		
NM-Motorservice Article no./ Artikelnummer/ Modelo número/ статья номер	NM-Motorservice Article no.:	NM-Motorservice Article no.:			NM-Motorservice Article no.:		NM-Motorservice Article no.:	NM-Motorservice Article no.:	NM-Motorservice Article no.:		NM-Motorservice Article no.:
	LBS 13500 PB LBS 13500 SB	LB 13500 P LB 13500 S			KBS 13500 B		KB 13500 B	KR 13500	PB 13500		

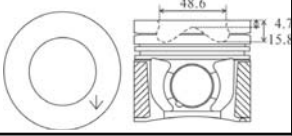

ENGINE TYPE Motortyp/ tipo de motor/ тип двигателя	LINER KIT Liner Kit/ camisas de los cilindros/ Лайнер комплект	CYL. LINER Zylinderlaufbuchse/ camisas de los cilindros/ втулка цилиндра			PISTON + RINGS Kolben + Ringe/ Pistón + Anillos/ поршень и кольца		PISTON SET Kolben Set/ Pistón Set/ поршневой	RINGS SET Ring Set/ Anillos Set/ кольца			PIN Pin/ Perno/ Пин
CONCERTO 1.8 TD (1994.10-1995.12) 1,769 cc 4 cyl 80.0 mm Bore Ø			Flanged	No flange	Piston		Alfin head anodized	Rings			
		Length: Outside Ø: Flange Ø: Flange depth:	154.0 83.0 86.0 4.5	154.0 83.0	Length: Comp. height:	84.5 46.8 -1.85		Top: 2nd: oil:	3.0 2.0 3.0	Ø: Length:	28.0 68.0
		Reference no.:					Reference no.:	Reference no.:	Reference no.:		
							A-A350536 K-90354600 M-0397300 N-8732360000	A-R49910 G-0832360000 K-800003340000 M-03973N0			
NM-Motorservice Article no./ Artikelnummer/ Modelo número/ статья номер	NM-Motorservice Article no.:	NM-Motorservice Article no.:			NM-Motorservice Article no.:		NM-Motorservice Article no.:	NM-Motorservice Article no.:	NM-Motorservice Article no.:		NM-Motorservice Article no.:
	LBS 13550 PA LBS 13550 SA	LB 13550 P LB 13550 S			KBS 13550 A		KB 13550 A	KR 13550	PB 13550		

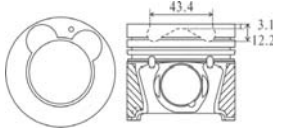

ENGINE TYPE Motortyp/ tipo de motor/ тип двигателя	LINER KIT Liner Kit/ camisas de los cilindros/ Лайнер комплект	CYL. LINER Zylinderlaufbuchse/ camisas de los cilindros/ втулка цилиндра			PISTON + RINGS Kolben + Ringe/ Pistón + Anillos/ поршень и кольца		PISTON SET Kolben Set/ Pistón Set/ поршневой	RINGS SET Ring Set/ Anillos Set/ кольца			PIN Pin/ Perno/ Пин
20T2N TURBO 20T2R TURBO ACCORD CIVIC 2.0 TDI - also for ROVER 1,994 cc 4 cyl 84.45 mm Bore Ø			Flanged	No flange	Piston		Alfin skirt MOS2 treated	Rings			
		Length: Outside Ø: Flange Ø: Flange depth:	158.5 88.0 90.5 4.0	158.5 88.0	Length: Comp. height:	76.97 47.97 -5.0 -17.0		Top: 2nd: oil:	3.0 2.0 3.0	Ø: Length:	30.0 70.0
		Reference no.:					Reference no.:	Reference no.:	Reference no.:		
							13000-P5T-G00 A-A350500 K-94401600 M-2014500	13011-P5T-G00 G-0811980000 A-R49390 K-800023640000			
NM-Motorservice Article no./ Artikelnummer/ Modelo número/ статья номер	NM-Motorservice Article no.:	NM-Motorservice Article no.:			NM-Motorservice Article no.:		NM-Motorservice Article no.:	NM-Motorservice Article no.:	NM-Motorservice Article no.:		NM-Motorservice Article no.:
	LBS 13600 PA LBS 13600 SA	LB 13600 P LB 13600 S			KBS 13600 A		KB 13600 A	KR 13600	PB 13600		

ENGINE TYPE Motortyp/ tipo de motor/ тип двигателя	LINER KIT Liner Kit/ camisas de los cilindros/ Лайнер комплект	CYL. LINER Zylinderlaufbuchse/ camisas de los cilindros/ штулка цилиндра		PISTON + RINGS Kolben + Ringe/ Pistón + Anillos/ поршень и кольца	PISTON SET Kolben Set/ Pistón Set/ поршневой	RINGS SET Ring Set/ Anillos Set/ кольца	PIN Pin/ Perno/ Пин	
N22A1/ N22A2 ACCORD CR-V 2.2DI-CTDI 2,204 cc 4 cyl 85.0 mm Bore Ø			Flanged	No flange	Piston Alfin and with oil gallery skirt MOS2 treated	Rings		
		Length: Outside Ø: Flange Ø: Flange depth:				Length: Comp. height:	73.0 47.0 -4.7 -15.8	Top: 2nd: oil:
		Reference no.:			Reference no.:	Reference no.:	Reference no.:	
						13010-RMA-E00 13020-RMA-E00 13030-RMA-E00	13011-RMA-E01 13011-RSR-E01 13021-RMA-E01 13021-RSR-E01	
NM-Motorservice Article no./ Artikelnummer/ Modelo нúmero/ статья номер	NM-Motorservice Article no.:	NM-Motorservice Article no.:		NM-Motorservice Article no.:	NM-Motorservice Article no.:	NM-Motorservice Article no.:	NM-Motorservice Article no.:	
	LBS 78000 PB LBS 78000 SB	LB 78000 P LB 78000 S		KBS 78000 B	KB 78000 B	KR 78000	PB 78000	

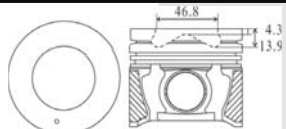



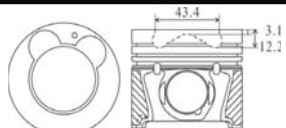

ENGINE TYPE Motortyp/ tipo de motor/ тип двигателя	LINER KIT Liner Kit/ camisas de los cilindros/ Лайнер комплект	CYL. LINER Zylinderlaufbuchse/ camisas de los cilindros/ втулка цилиндра		PISTON + RINGS Kolben + Ringe/ Pistón + Anillos/ поршень и кольца		PISTON SET Kolben Set/ Pistón Set/ поршневой	RINGS SET Ring Set/ Anillos Set/ кольца		PIN Pin/ Perno/ Пин		
D3FA GETZ 1.1 CRDI 1,119 cc 3 cyl 75.0 mm Bore Ø			Flanged	No flange	Piston		Alfin and with oil gallery skirt MOS2 treated		Rings		
		Length: Outside Ø: Flange Ø: Flange depth:	142.0 78.0 80.0 4.0	142.0 78.0	Length: Comp. height:	65.7 42.0 -3.1 -12.2	Top: 2nd: oil:	1.75 1.75 3.0	Ø: Length:	28.0 60.0	
		Reference no.:		Reference no.:		Reference no.:		Reference no.:		Reference no.:	
NM-Motorservice Article no./ Artikelnummer/ Modelo número/ статья номер	NM-Motorservice Article no.:	NM-Motorservice Article no.:		NM-Motorservice Article no.:		NM-Motorservice Article no.:		NM-Motorservice Article no.:		NM-Motorservice Article no.:	
	LBS 68500 PB LBS 68500 SB	LB 68500 P LB 68500 S		KBS 68500 B		KB 68500 B		KR 68500		PB 68500	

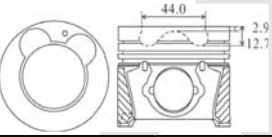

ENGINE TYPE Motortyp/ tipo de motor/ тип двигателя	LINER KIT Liner Kit/ camisas de los cilindros/ Лайнер комплект	CYL. LINER Zylinderlaufbuchse/ camisas de los cilindros/ втулка цилиндра		PISTON + RINGS Kolben + Ringe/ Pistón + Anillos/ поршень и кольца		PISTON SET Kolben Set/ Pistón Set/ поршневой	RINGS SET Ring Set/ Anillos Set/ кольца		PIN Pin/ Perno/ Пин		
D3EA ACCENT GETZ MATRIX 1.5 CRDI 1,493 cc 3 cyl 83.0 mm Bore Ø			Flanged	No flange	Piston		Alfin skirt MOS2 treated pin bushing inserted		Rings		
		Length: Outside Ø: Flange Ø: Flange depth:	153.5 86.0 89.0 4.8	153.5 86.0	Length: Comp. height:	72.3 46.3 -4.3 -13.9	Top: 2nd: oil:	2.0 2.0 3.0	Ø: Length:	28.0 65.5	
		Reference no.:		Reference no.:		Reference no.:		Reference no.:		Reference no.:	
NM-Motorservice Article no./ Artikelnummer/ Modelo número/ статья номер	NM-Motorservice Article no.:	NM-Motorservice Article no.:		NM-Motorservice Article no.:		NM-Motorservice Article no.:		NM-Motorservice Article no.:		NM-Motorservice Article no.:	
	LBS 44000 PA LBS 44000 SA	LB 44000 P LB 44000 S		KBS 44000 A		KB 44000 A		KR 44000		PB 44000	

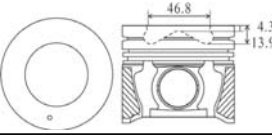

ENGINE TYPE Motortyp/ tipo de motor/ тип двигателя	LINER KIT Liner Kit/ camisas de los cilindros/ Лайнер комплект	CYL. LINER Zylinderlaufbuchse/ camisas de los cilindros/ втулка цилиндра		PISTON + RINGS Kolben + Ringe/ Pistón + Anillos/ поршень и кольца		PISTON SET Kolben Set/ Pistón Set/ поршневой	RINGS SET Ring Set/ Anillos Set/ кольца		PIN Pin/ Perno/ Пин		
D4FA 1,493 cc 4 cyl 75.0 mm Bore Ø			Flanged	No flange	Piston		Alfin and with oil gallery skirt MOS2		Rings		
		Length: Outside Ø: Flange Ø: Flange depth:	142.0 78.0 80.0 4.0	142.0 78.0	Length: Comp. height:	65.7 42.0 -3.1 -12.2	Top: 2nd: oil:	1.75 1.75 3.0	Ø: Length:	28.0 60.0	
		Reference no.:		Reference no.:		Reference no.:		Reference no.:		Reference no.:	
NM-Motorservice Article no./ Artikelnummer/ Modelo número/ статья номер	NM-Motorservice Article no.:	NM-Motorservice Article no.:		NM-Motorservice Article no.:		NM-Motorservice Article no.:		NM-Motorservice Article no.:		NM-Motorservice Article no.:	
	LBS 69500 PB LBS 69500 SB	LB 69500 P LB 69500 S		KBS 69500 B		KB 69500 B		KR 69500		PB 69500	

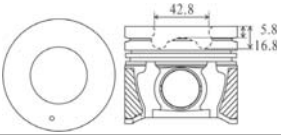

ENGINE TYPE Motortyp/ tipo de motor/ тип двигателя	LINER KIT Liner Kit/ camisas de los cilindros/ Лайнер комплект	CYL. LINER Zylinderlaufbuchse/ camisas de los cilindros/ втулка цилиндра		PISTON + RINGS Kolben + Ringe/ Pistón + Anillos/ поршень и кольца	PISTON SET Kolben Set/ Pistón Set/ поршневой	RINGS SET Ring Set/ Anillos Set/ кольца	PIN Pin/ Perno/ Пин
D4FC CRDi I20 1.4 1,396 cc 4 cyl 75.0 mm Bore Ø			Liner/ Sleeve	Piston	Alfin and with oil gallery	Rings	Ø : Length:
		Length: Outside Ø: Flange Ø: Flange depth:	Length: Comp. height:				
		Reference no.:	Reference no.:	Reference no.:	Reference no.:	Reference no.:	
				O-Ring:			
NM-Motorservice Article no./ Artikelnummer/ Modelo número/ статья номер	NM-Motorservice Article no.:	NM-Motorservice Article no.:		NM-Motorservice Article no.:	NM-Motorservice Article no.:	NM-Motorservice Article no.:	NM-Motorservice Article no.:
				KBS 39600 B	KB 39600 B		

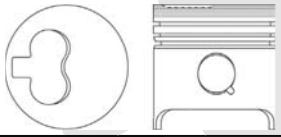

ENGINE TYPE Motortyp/ tipo de motor/ тип двигателя	LINER KIT Liner Kit/ camisas de los cilindros/ Лайнер комплект	CYL. LINER Zylinderlaufbuchse/ camisas de los cilindros/ втулка цилиндра		PISTON + RINGS Kolben + Ringe/ Pistón + Anillos/ поршень и кольца	PISTON SET Kolben Set/ Pistón Set/ поршневой	RINGS SET Ring Set/ Anillos Set/ кольца	PIN Pin/ Perno/ Пин	
D4FB D4FB 1,582 cc 4 cyl 77.2 mm Bore Ø			Flanged	No flange	Piston	Alfin and with oil gallery skirt MOS2 treated	Rings	Ø : Length:
		Length: Outside Ø: Flange Ø: Flange depth:	Length: Comp. height:	65.7 42.0 -2.9 -12.7				
		Reference no.:	Reference no.:	Reference no.:	Reference no.:	Reference no.:		
					23410-2A961 23410-2A962 23410-2A963 23410-2A964 23410-2A965	23040-2A960 23040-2A961 23040-2A962	23517-2A600	
NM-Motorservice Article no./ Artikelnummer/ Modelo número/ статья номер	NM-Motorservice Article no.:	NM-Motorservice Article no.:		NM-Motorservice Article no.:	NM-Motorservice Article no.:	NM-Motorservice Article no.:	NM-Motorservice Article no.:	
	LBS 70500 PB LBS 70500 SB	LB 70500 P LB 70500 S		KBS 70500 B	KB 70500 B	KR 70500	PB 70500	

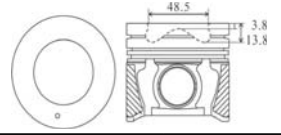

ENGINE TYPE Motortyp/ tipo de motor/ тип двигателя	LINER KIT Liner Kit/ camisas de los cilindros/ Лайнер комплект	CYL. LINER Zylinderlaufbuchse/ camisas de los cilindros/ втулка цилиндра		PISTON + RINGS Kolben + Ringe/ Pistón + Anillos/ поршень и кольца	PISTON SET Kolben Set/ Pistón Set/ поршневой	RINGS SET Ring Set/ Anillos Set/ кольца	PIN Pin/ Perno/ Пин		
D4EA ELANTRA SANTA FE 2.0 CRDi 1,991 cc 4 cyl 83.0 mm Bore Ø			Flanged	No flange	Piston	Alfin skirt MOS2 treated pin bushing inserted	Rings	Ø : Length:	
		Length: Outside Ø: Flange Ø: Flange depth:	Length: Comp. height:	153.5 86.0 89.0 4.8					153.5 86.0
		Reference no.:	Reference no.:	Reference no.:	Reference no.:	Reference no.:			
					23410-27901 23410-27903 23410-27904 23410-27921 23410-27923 23410-27924	23040-27900 23040-27901 23040-27902 23040-27910 23040-27911/2 23040-27920/1/2	23517-27000		
NM-Motorservice Article no./ Artikelnummer/ Modelo número/ статья номер	NM-Motorservice Article no.:	NM-Motorservice Article no.:		NM-Motorservice Article no.:	NM-Motorservice Article no.:	NM-Motorservice Article no.:	NM-Motorservice Article no.:		
	LBS 24000 PA LBS 24000 SA	LB 24000 P LB 24000 S		KBS 24000 A	KB 24000 A	KR 24000	PB 24000		

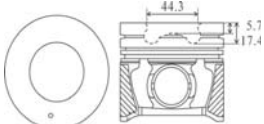

ENGINE TYPE Motortyp/ tipo de motor/ тип двигателя	LINER KIT Liner Kit/ camisas de los cilindros/ Лайнер комплект	CYL. LINER Zylinderlaufbuchse/ camisas de los cilindros/ втулка цилиндра	PISTON + RINGS Kolben + Ringe/ Pistón + Anillos/ поршень и кольца	PISTON SET Kolben Set/ Pistón Set/ поршневой	RINGS SET Ring Set/ Anillos Set/ кольца	PIN Pin/ Perno/ Пин																																					
D4EA New 1,991 cc 4 cyl 83.0 mm Bore Ø		<table border="1"> <tr> <td></td> <td>Flanged</td> <td>No flange</td> </tr> <tr> <td>Length:</td> <td>153.5</td> <td>153.5</td> </tr> <tr> <td>Outside Ø:</td> <td>86.0</td> <td>86.0</td> </tr> <tr> <td>Flange Ø:</td> <td>89.0</td> <td></td> </tr> <tr> <td>Flange depth:</td> <td>4.8</td> <td></td> </tr> </table>		Flanged	No flange	Length:	153.5	153.5	Outside Ø:	86.0	86.0	Flange Ø:	89.0		Flange depth:	4.8		<table border="1"> <tr> <td colspan="2">Piston</td> </tr> <tr> <td>Length:</td> <td>72.3</td> </tr> <tr> <td>Comp. height:</td> <td>46.3</td> </tr> <tr> <td></td> <td>-5.8</td> </tr> <tr> <td></td> <td>-16.8</td> </tr> </table>	Piston		Length:	72.3	Comp. height:	46.3		-5.8		-16.8	Alfin and with oil gallery skirt MOS2 treated pin bushing inserted	<table border="1"> <tr> <td colspan="2">Rings</td> </tr> <tr> <td>Top:</td> <td>2.0</td> </tr> <tr> <td>2nd:</td> <td>2.0</td> </tr> <tr> <td>oil:</td> <td>3.0</td> </tr> </table>	Rings		Top:	2.0	2nd:	2.0	oil:	3.0	<table border="1"> <tr> <td>Ø:</td> <td>28.0</td> </tr> <tr> <td>Length:</td> <td>65.5</td> </tr> </table>	Ø:	28.0	Length:	65.5
				Flanged	No flange																																						
Length:	153.5	153.5																																									
Outside Ø:	86.0	86.0																																									
Flange Ø:	89.0																																										
Flange depth:	4.8																																										
Piston																																											
Length:	72.3																																										
Comp. height:	46.3																																										
	-5.8																																										
	-16.8																																										
Rings																																											
Top:	2.0																																										
2nd:	2.0																																										
oil:	3.0																																										
Ø:	28.0																																										
Length:	65.5																																										
	Reference no.:	Reference no.:	Reference no.:	Reference no.:	Reference no.:																																						
				23410-27930	23040-27900 23040-27901 23040-27902 23040-27910 23040-27911/2 23040-27920/1/2	23517-27000																																					
NM-Motorservice Article no./ Artikelnummer/ Modelo número/ статья номер	NM-Motorservice Article no.:	NM-Motorservice Article no.:	NM-Motorservice Article no.:	NM-Motorservice Article no.:	NM-Motorservice Article no.:	NM-Motorservice Article no.:																																					
	LBS 24001 PB LBS 24001 SB	LB 24001 P LB 24001 S	KBS 24001 B	KB 24001 B	KR 24001	PB 24001																																					

ENGINE TYPE Motortyp/ tipo de motor/ тип двигателя	LINER KIT Liner Kit/ camisas de los cilindros/ Лайнер комплект	CYL. LINER Zylinderlaufbuchse/ camisas de los cilindros/ втулка цилиндра	PISTON + RINGS Kolben + Ringe/ Pistón + Anillos/ поршень и кольца	PISTON SET Kolben Set/ Pistón Set/ поршневой	RINGS SET Ring Set/ Anillos Set/ кольца	PIN Pin/ Perno/ Пин																																			
DJY XUD 9A ELANTRA LANTRA 1.9 D 1,905 cc 4 cyl 83.0 mm Bore Ø		<table border="1"> <tr> <td></td> <td>Flanged</td> <td>No flange</td> </tr> <tr> <td>Length:</td> <td>153.5</td> <td>153.5</td> </tr> <tr> <td>Outside Ø:</td> <td>86.0</td> <td>86.0</td> </tr> <tr> <td>Flange Ø:</td> <td>89.0</td> <td></td> </tr> <tr> <td>Flange depth:</td> <td>4.8</td> <td></td> </tr> </table>		Flanged	No flange	Length:	153.5	153.5	Outside Ø:	86.0	86.0	Flange Ø:	89.0		Flange depth:	4.8		<table border="1"> <tr> <td colspan="2">Piston</td> </tr> <tr> <td>Length:</td> <td>84.3</td> </tr> <tr> <td>Comp. height:</td> <td>46.8</td> </tr> <tr> <td></td> <td>-2.2</td> </tr> </table>	Piston		Length:	84.3	Comp. height:	46.8		-2.2		<table border="1"> <tr> <td colspan="2">Rings</td> </tr> <tr> <td>Top:</td> <td>2.0</td> </tr> <tr> <td>2nd:</td> <td>2.0</td> </tr> <tr> <td>oil:</td> <td>3.0</td> </tr> </table>	Rings		Top:	2.0	2nd:	2.0	oil:	3.0	<table border="1"> <tr> <td>Ø:</td> <td>25.0</td> </tr> <tr> <td>Length:</td> <td>72.0</td> </tr> </table>	Ø:	25.0	Length:	72.0
				Flanged	No flange																																				
Length:	153.5	153.5																																							
Outside Ø:	86.0	86.0																																							
Flange Ø:	89.0																																								
Flange depth:	4.8																																								
Piston																																									
Length:	84.3																																								
Comp. height:	46.8																																								
	-2.2																																								
Rings																																									
Top:	2.0																																								
2nd:	2.0																																								
oil:	3.0																																								
Ø:	25.0																																								
Length:	72.0																																								
	Reference no.:	Reference no.:	Reference no.:	Reference no.:	Reference no.:	Reference no.:																																			
	K-93648970 M-0392490 M-0392491	K-89184190 M-039VV21 M-039VV32	A-350709 K-93648700 M-0392400 N-8715200010		A-R66390 G-0815200000 K-800003740000 M-03924N0																																				
NM-Motorservice Article no./ Artikelnummer/ Modelo número/ статья номер	NM-Motorservice Article no.:	NM-Motorservice Article no.:	NM-Motorservice Article no.:	NM-Motorservice Article no.:	NM-Motorservice Article no.:	NM-Motorservice Article no.:																																			
	LBS 39800 P LBS 39800 S	LB 39800 P LB 39800 S	KBS 39800	KB 39800	KR 39800	PB 39800																																			

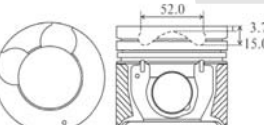
ENGINE TYPE Motortyp/ tipo de motor/ тип двигателя	LINER KIT Liner Kit/ camisas de los cilindros/ Лайнер комплект	CYL. LINER Zylinderlaufbuchse/ camisas de los cilindros/ втулка цилиндра	PISTON + RINGS Kolben + Ringe/ Pistón + Anillos/ поршень и кольца	PISTON SET Kolben Set/ Pistón Set/ поршневой	RINGS SET Ring Set/ Anillos Set/ кольца	PIN Pin/ Perno/ Пин																																					
D4EA SANTA FE 1,991 cc 4 cyl 83.0 mm Bore Ø		<table border="1"> <tr> <td></td> <td>Flanged</td> <td>No flange</td> </tr> <tr> <td>Length:</td> <td>153.5</td> <td>153.5</td> </tr> <tr> <td>Outside Ø:</td> <td>86.0</td> <td>86.0</td> </tr> <tr> <td>Flange Ø:</td> <td>89.0</td> <td></td> </tr> <tr> <td>Flange depth:</td> <td>4.8</td> <td></td> </tr> </table>		Flanged	No flange	Length:	153.5	153.5	Outside Ø:	86.0	86.0	Flange Ø:	89.0		Flange depth:	4.8		<table border="1"> <tr> <td colspan="2">Piston</td> </tr> <tr> <td>Length:</td> <td>72.3</td> </tr> <tr> <td>Comp. height:</td> <td>46.3</td> </tr> <tr> <td></td> <td>-3.8</td> </tr> <tr> <td></td> <td>-13.8</td> </tr> </table>	Piston		Length:	72.3	Comp. height:	46.3		-3.8		-13.8	Alfin and with oil gallery skirt MOS2 treated pin bushing inserted	<table border="1"> <tr> <td colspan="2">Rings</td> </tr> <tr> <td>Top:</td> <td>2.0</td> </tr> <tr> <td>2nd:</td> <td>2.0</td> </tr> <tr> <td>oil:</td> <td>3.0</td> </tr> </table>	Rings		Top:	2.0	2nd:	2.0	oil:	3.0	<table border="1"> <tr> <td>Ø:</td> <td>28.0</td> </tr> <tr> <td>Length:</td> <td>65.5</td> </tr> </table>	Ø:	28.0	Length:	65.5
				Flanged	No flange																																						
Length:	153.5	153.5																																									
Outside Ø:	86.0	86.0																																									
Flange Ø:	89.0																																										
Flange depth:	4.8																																										
Piston																																											
Length:	72.3																																										
Comp. height:	46.3																																										
	-3.8																																										
	-13.8																																										
Rings																																											
Top:	2.0																																										
2nd:	2.0																																										
oil:	3.0																																										
Ø:	28.0																																										
Length:	65.5																																										
	Reference no.:	Reference no.:	Reference no.:	Reference no.:	Reference no.:																																						
				23410-27910	23040-27900 23040-27901 23040-27902 23040-27910 23040-27911/2 23040-27920/1/2	23517-27000																																					
NM-Motorservice Article no./ Artikelnummer/ Modelo número/ статья номер	NM-Motorservice Article no.:	NM-Motorservice Article no.:	NM-Motorservice Article no.:	NM-Motorservice Article no.:	NM-Motorservice Article no.:	NM-Motorservice Article no.:																																					
	LBS 39850 PB LBS 39850 SB	LB 39850 P LB 39850 S	KBS 39850 B	KB 39850 B	KR 39850	PB 39850																																					

ENGINE TYPE Motor/тип de motor/ тип двигателя	LINER KIT Liner Kit/ camisas de los cilindros/ Лайнер комплект	CYL. LINER Zylinderlaufbuchse/ camisas de los cilindros/ втулка цилиндра		PISTON + RINGS Kolben + Ringe/ Pistón + Anillos/ поршень и кольца		PISTON SET Kolben Set/ Pistón Set/ поршневой	RINGS SET Ring Set/ Anillos Set/ кольца		PIN Pin/ Perno/ Пин	
D4EB-F D4EB-G SANTA FE 2.2 CRDI 2,188 cc 4 cyl 87.0 mm Bore Ø			Flanged	No flange	Piston		Alfin and with oil gallery skirt MOS2 treated pin bushing inserted	Rings		Ø : 28.0 Length: 72.0
		Length: 162.0 Outside Ø: 91.05 Flange Ø: 92.5 Flange depth: 4.0	162.0 91.05	Length: 72.3 Comp. height: 46.3 -5.7 -17.4	Reference no.:	Reference no.:		Reference no.:	Reference no.:	
						23410-27940 23410-27941 23410-27942 23410-27943 23410-27944	23040-27940 23040-27941 23040-27942	23517-27000		
NM-Motorservice Article no./ Artikelnummer/ Modelo número/ статья номер	NM-Motorservice Article no.:	NM-Motorservice Article no.:		NM-Motorservice Article no.:		NM-Motorservice Article no.:	NM-Motorservice Article no.:	NM-Motorservice Article no.:		NM-Motorservice Article no.:
	LBS 71500 PB LBS 71500 SB	LB 71500 P LB 71500 S		KBS 71500 B		KB 71500 B	KR 71500	PB 71500		

ENGINE TYPE Motor/тип de motor/ тип двигателя	LINER KIT Liner Kit/ camisas de los cilindros/ Лайнер комплект	CYL. LINER Zylinderlaufbuchse/ camisas de los cilindros/ втулка цилиндра		PISTON + RINGS Kolben + Ringe/ Pistón + Anillos/ поршень и кольца		PISTON SET Kolben Set/ Pistón Set/ поршневой	RINGS SET Ring Set/ Anillos Set/ кольца		PIN Pin/ Perno/ Пин	
D4CB CRDi PORTER II 2,497 cc 4 cyl 91.0 mm Bore Ø			Flanged	No flange	Piston		Alfin and with oil gallery skirt MOS2 treated	Rings		Ø : 33.0 Length: 75.0
		Length: 170.5 Outside Ø: 94.15 Flange Ø: 98.15 Flange depth: 2.0	170.5 94.15	Length: 83.7 Comp. height: 54.2 -3.7 -15.0	Reference no.:	Reference no.:		Reference no.:	Reference no.:	
						23410-4A900 23410-4A901 23410-4A902 23410-4A910 23410-4A911 23410-4A912 23410-4A913 23410-4A914	23040-4A900 23040-4A901 23040-4A902 23040-4A910 23040-4A911 23040-4A912			
NM-Motorservice Article no./ Artikelnummer/ Modelo número/ статья номер	NM-Motorservice Article no.:	NM-Motorservice Article no.:		NM-Motorservice Article no.:		NM-Motorservice Article no.:	NM-Motorservice Article no.:	NM-Motorservice Article no.:		NM-Motorservice Article no.:
	LBS 25000 PB LBS 25000 SB	LB 25000 P LB 25000 S		KBS 25000 B		KB 25000 B	KR 25000	PB 25000		

ENGINE TYPE Motor/тип de motor/ тип двигателя	LINER KIT Liner Kit/ camisas de los cilindros/ Лайнер комплект	CYL. LINER Zylinderlaufbuchse/ camisas de los cilindros/ втулка цилиндра		PISTON + RINGS Kolben + Ringe/ Pistón + Anillos/ поршень и кольца		PISTON SET Kolben Set/ Pistón Set/ поршневой	RINGS SET Ring Set/ Anillos Set/ кольца		PIN Pin/ Perno/ Пин	
D4BA H100 PORTER 2,476 cc 4 cyl 91.1 mm Bore Ø			Flanged	No flange	Piston			Rings		Ø : 29.0 Length: 75.0
		Length: 165.0 Outside Ø: 94.2 Flange Ø: 98.1 Flange depth: 2.0	165.0 94.2	Length: 88.7 Comp. height: 48.7 -2.2 -3.5	Reference no.:	Reference no.:		Reference no.:	Reference no.:	
						23410-42201 23410-42211 23410-42221	23040-42200 23040-42202 23040-42210	23517-42001		
NM-Motorservice Article no./ Artikelnummer/ Modelo número/ статья номер	NM-Motorservice Article no.:	NM-Motorservice Article no.:		NM-Motorservice Article no.:		NM-Motorservice Article no.:	NM-Motorservice Article no.:	NM-Motorservice Article no.:		NM-Motorservice Article no.:
	LBS 40000 P LBS 40000 S LBS 40000 PA LBS 40000 SA	LB 40000 P LB 40000 S		KBS 40000 KBS 40000 A		KB 40000 KB 40000 A	KR 40000	PB 40000		

ENGINE TYPE Motortyp/ tipo de motor/ тип двигателя	LINER KIT Liner Kit/ camisas de los cilindros/ Лайнер комплект	CYL. LINER Zylinderlaufbuchse/ camisas de los cilindros/ втулка цилиндра		PISTON + RINGS Kolben + Ringe/ Pistón + Anillos/ поршень и кольца		PISTON SET Kolben Set/ Pistón Set/ поршневой	RINGS SET Ring Set/ Anillos Set/ кольца		PIN Pin/ Perno/ Пин	
D4BB 2,476 cc 4 cyl 91.1 mm Bore Ø			Flanged	No flange	Piston		Alfin Skirt MOS2 treated	Rings		
		Length: Outside Ø: Flange Ø: Flange depth:	165.0 94.2 98.1 2.0	165.0 94.2	Length: Comp. height:	76.2 46.2 -2.2 -3.4		Top: 2nd: oil:	2.0 2.0 3.0	Ø: Length:
		Reference no.:		Reference no.:		Reference no.:	Reference no.:	Reference no.:		Reference no.:
		21131-42001				23410-42202 23410-42701 23410-42711 23410-42721	23040-42200 23040-42202 23040-42210	23517-42001		
NM-Motorservice Article no./ Artikelnummer/ Modelo número/ статья номер		NM-Motorservice Article no.:		NM-Motorservice Article no.:		NM-Motorservice Article no.:	NM-Motorservice Article no.:	NM-Motorservice Article no.:		NM-Motorservice Article no.:
		LBS 40050 PA LBS 40050 SA		LB 40050 P LB 40050 S		KBS 40050 A	KB 40050 A	KR 40050		PB 40050



ENGINE TYPE Motortyp/ tipo de motor/ тип двигателя	LINER KIT Liner Kit/ camisas de los cilindros/ Лайнер комплект	CYL. LINER Zylinderlaufbuchse/ camisas de los cilindros/ втулка цилиндра		PISTON + RINGS Kolben + Ringe/ Pistón + Anillos/ поршень и кольца		PISTON SET Kolben Set/ Pistón Set/ поршневой	RINGS SET Ring Set/ Anillos Set/ кольца		PIN Pin/ Perno/ Пин	
D4BF 2,476 cc 4 cyl 91.1 mm Bore Ø			Flanged	No flange	Piston			Rings		
		Length: Outside Ø: Flange Ø: Flange depth:	165.0 94.2 98.1 2.0	165.0 94.2	Length: Comp. height:	88.7 48.7 -2.3 -2.6		Top: 2nd: oil:	2.5 2.0 4.0	Ø: Length:
		Reference no.:		Reference no.:		Reference no.:	Reference no.:	Reference no.:		Reference no.:
		21131-42001				23410-42850 23410-42860 23410-42870	23040-42510 23040-42520 23040-42521 23040-42530 23040-42850 23040-42851	23517-42001		
NM-Motorservice Article no./ Artikelnummer/ Modelo número/ статья номер		NM-Motorservice Article no.:		NM-Motorservice Article no.:		NM-Motorservice Article no.:	NM-Motorservice Article no.:	NM-Motorservice Article no.:		NM-Motorservice Article no.:
		LBS 40100 PA LBS 40100 SA		LB 40100 P LB 40100 S		KBS 40100 A	KB 40100 A	KR 40100		PB 40100



ENGINE TYPE Motortyp/ tipo de motor/ тип двигателя	LINER KIT Liner Kit/ camisas de los cilindros/ Лайнер комплект	CYL. LINER Zylinderlaufbuchse/ camisas de los cilindros/ втулка цилиндра		PISTON + RINGS Kolben + Ringe/ Pistón + Anillos/ поршень и кольца		PISTON SET Kolben Set/ Pistón Set/ поршневой	RINGS SET Ring Set/ Anillos Set/ кольца		PIN Pin/ Perno/ Пин	
D4BX H100 GRACE PORTER 2,476 cc 4 cyl 91.1 mm Bore Ø			Flanged	No flange	Piston		Reference no.:	Rings		
		Length: Outside Ø: Flange Ø: Flange depth:	165.0 94.2 98.1 2.0	165.0 94.2	Length: Comp. height:	88.7 48.7 -0.4 -3.4		Top: 2nd: oil:	2.5 2.0 4.0	Ø: Length:
		Reference no.:		Reference no.:		Reference no.:	Reference no.:	Reference no.:		Reference no.:
		21131-42001				23410-42000 23410-42010 23410-42020 23410-42901 23410-42902 23410-42903 23410-42904	23040-42000	23517-42001		
NM-Motorservice Article no./ Artikelnummer/ Modelo número/ статья номер		NM-Motorservice Article no.:		NM-Motorservice Article no.:		NM-Motorservice Article no.:	NM-Motorservice Article no.:	NM-Motorservice Article no.:		NM-Motorservice Article no.:
		LBS 40150 P LBS 40150 S		LB 40150 P LB 40150 S		KBS 40150	KB 40150	KR 40150		PB 40150

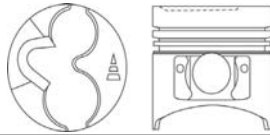

ENGINE TYPE Motortyp/ tipo de motor/ тип двигателя	LINER KIT Liner Kit/ camisas de los cilindros/ Лайнер комплект	CYL. LINER Zylinderlaufbuchse/ camisas de los cilindros/ втулка цилиндра		PISTON + RINGS Kolben + Ringe/ Pistón + Anillos/ поршень и кольца		PISTON SET Kolben Set/ Pistón Set/ поршневой	RINGS SET Ring Set/ Anillos Set/ кольца		PIN Pin/ Perno/ Пин		
D4BX New H100 GRACE PORTER 2,476 cc 4 cyl 91.1 mm Bore Ø			Flanged	No flange	Piston		Rings				
		Length:	165.0	165.0	Length:	88.7	Top:	2.0	Ø:	29.0	
		Outside Ø:	94.2	94.2	Comp. height:	48.7	2nd:	2.0	Length:	75.0	
		Flange Ø:	98.1			oil:	4.0				
		Flange depth:	2.0			Reference no.:		Reference no.:		Reference no.:	
						23410-42030 23410-42040 23410-42050 23410-42911 23410-42912 23410-42913 23410-42914	23040-42010		23517-42001		
		Reference no.:		Reference no.:							
		21131-42001									
NM-Motorservice Article no./ Artikelnummer/ Modelo número/ статья номер	NM-Motorservice Article no.:	NM-Motorservice Article no.:		NM-Motorservice Article no.:		NM-Motorservice Article no.:	NM-Motorservice Article no.:	NM-Motorservice Article no.:	NM-Motorservice Article no.:		
	LBS 40200 P LBS 40200 S	LB 40200 P LB 40200 S		KBS 40200		KB 40200	KR 40200	PB 40200			

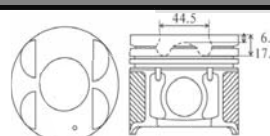

ENGINE TYPE Motortyp/ tipo de motor/ тип двигателя	LINER KIT Liner Kit/ camisas de los cilindros/ Лайнер комплект	CYL. LINER Zylinderlaufbuchse/ camisas de los cilindros/ втулка цилиндра		PISTON + RINGS Kolben + Ringe/ Pistón + Anillos/ поршень и кольца		PISTON SET Kolben Set/ Pistón Set/ поршневой	RINGS SET Ring Set/ Anillos Set/ кольца		PIN Pin/ Perno/ Пин		
D4BH (L/R) 2,476 cc 4 cyl 91.1 mm Bore Ø			Flanged	No flange	Piston		Rings				
		Length:	165.0	165.0	Length:	88.7	Top:	2.5	Ø:	29.0	
		Outside Ø:	94.2	94.2	Comp. height:	48.7	2nd:	2.0	Length:	75.0	
		Flange Ø:	98.1			oil:	4.0				
		Flange depth:	2.0			Reference no.:		Reference no.:		Reference no.:	
						Alfin and with oil gallery	23040-42510 23040-42520 23040-42521 23040-42530 23040-42850 23040-42851		23517-42001		
		Reference no.:		Reference no.:		Reference no.:		Reference no.:		Reference no.:	
		21131-42001				23410-42500 23410-42520 23410-42600 23410-42630 (L/R)		23040-42510 23040-42520 23040-42521 23040-42530 23040-42850 23040-42851		23517-42001	
NM-Motorservice Article no./ Artikelnummer/ Modelo número/ статья номер	NM-Motorservice Article no.:	NM-Motorservice Article no.:		NM-Motorservice Article no.:		NM-Motorservice Article no.:	NM-Motorservice Article no.:	NM-Motorservice Article no.:	NM-Motorservice Article no.:		
	LBS 40250 PB LBS 40250 SB	LB 40250 P LB 40250 S		KBS 40250 B		KB 40250 B	KR 40250	PB 40250			

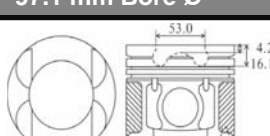

ENGINE TYPE Motortyp/ tipo de motor/ тип двигателя	LINER KIT Liner Kit/ camisas de los cilindros/ Лайнер комплект	CYL. LINER Zylinderlaufbuchse/ camisas de los cilindros/ втулка цилиндра		PISTON + RINGS Kolben + Ringe/ Pistón + Anillos/ поршень и кольца		PISTON SET Kolben Set/ Pistón Set/ поршневой	RINGS SET Ring Set/ Anillos Set/ кольца		PIN Pin/ Perno/ Пин		
D4BH TCi (L/R) 2,476 cc 4 cyl 91.1 mm Bore Ø			Flanged	No flange	Piston		Rings				
		Length:	165.0	165.0	Length:	88.7	Top:	2.5	Ø:	29.0	
		Outside Ø:	94.2	94.2	Comp. height:	48.7	2nd:	2.0	Length:	75.0	
		Flange Ø:	98.1			oil:	4.0				
		Flange depth:	2.0			Reference no.:		Reference no.:		Reference no.:	
						Alfin and with oil gallery	23040-42510 23040-42520 23040-42521 23040-42530 23040-42850 23040-42851		23517-42001		
		Reference no.:		Reference no.:		Reference no.:		Reference no.:		Reference no.:	
		21131-42001				23410-42540 23410-42544 (L/R)		23040-42510 23040-42520 23040-42521 23040-42530 23040-42850 23040-42851		23517-42001	
NM-Motorservice Article no./ Artikelnummer/ Modelo número/ статья номер	NM-Motorservice Article no.:	NM-Motorservice Article no.:		NM-Motorservice Article no.:		NM-Motorservice Article no.:	NM-Motorservice Article no.:	NM-Motorservice Article no.:	NM-Motorservice Article no.:		
	LBS 40300 PB LBS 40300 SB	LB 40300 P LB 40300 S		KBS 40300 B		KB 40300 B	KR 40300	PB 40300			

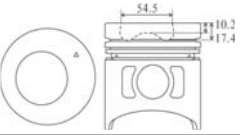

ENGINE TYPE Motortyp/ tipo de motor/ тип двигателя	LINER KIT Liner Kit/ camisas de los cilindros/ Лайнер комплект	CYL. LINER Zylinderlaufbuchse/ camisas de los cilindros/ втулка цилиндра	PISTON + RINGS Kolben + Ringe/ Pistón + Anillos/ поршень и кольца	PISTON SET Kolben Set/ Pistón Set/ поршневой	RINGS SET Ring Set/ Anillos Set/ кольца	PIN Pin/ Perno/ Пин																																			
D4BH (L/R) (2001-2004) 2,476 cc 4 cyl 91.1 mm Bore Ø		<table border="1"> <tr> <td></td> <td>Flanged</td> <td>No flange</td> </tr> <tr> <td>Length:</td> <td>165.0</td> <td>165.0</td> </tr> <tr> <td>Outside Ø:</td> <td>94.2</td> <td>94.2</td> </tr> <tr> <td>Flange Ø:</td> <td>98.1</td> <td></td> </tr> <tr> <td>Flange depth:</td> <td>2.0</td> <td></td> </tr> </table>		Flanged	No flange	Length:	165.0	165.0	Outside Ø:	94.2	94.2	Flange Ø:	98.1		Flange depth:	2.0		<table border="1"> <tr> <td colspan="2">Piston</td> </tr> <tr> <td>Length:</td> <td>88.7</td> </tr> <tr> <td>Comp. height:</td> <td>48.7</td> </tr> <tr> <td></td> <td>-3.0</td> </tr> </table>	Piston		Length:	88.7	Comp. height:	48.7		-3.0	Alfin and with oil gallery	<table border="1"> <tr> <td colspan="2">Rings</td> </tr> <tr> <td>Top:</td> <td>2.5</td> </tr> <tr> <td>2nd:</td> <td>2.0</td> </tr> <tr> <td>oil:</td> <td>4.0</td> </tr> </table>	Rings		Top:	2.5	2nd:	2.0	oil:	4.0	<table border="1"> <tr> <td>Ø:</td> <td>29.0</td> </tr> <tr> <td>Length:</td> <td>75.0</td> </tr> </table>	Ø:	29.0	Length:	75.0
			Flanged	No flange																																					
Length:	165.0	165.0																																							
Outside Ø:	94.2	94.2																																							
Flange Ø:	98.1																																								
Flange depth:	2.0																																								
Piston																																									
Length:	88.7																																								
Comp. height:	48.7																																								
	-3.0																																								
Rings																																									
Top:	2.5																																								
2nd:	2.0																																								
oil:	4.0																																								
Ø:	29.0																																								
Length:	75.0																																								
	Reference no.:	Reference no.:	Reference no.:	Reference no.:	Reference no.:																																				
	21131-42001			23411-42600 23411-42610 1+3 23411-42620 23411-42630 23411-42640 23411-42650	23040-42510 23040-42520 23040-42521 23040-42530 23040-42850 23040-42851	23517-42001																																			
NM-Motorservice Article no./ Artikelnummer/ Modelo número/ статья номер	NM-Motorservice Article no.:	NM-Motorservice Article no.:	NM-Motorservice Article no.:	NM-Motorservice Article no.:	NM-Motorservice Article no.:	NM-Motorservice Article no.:																																			
	LBS 40350 PB LBS 40350 SB	LB 40350 P LB 40350 S	KBS 40350 B	KB 40350 B	KR 40350	PB 40350																																			

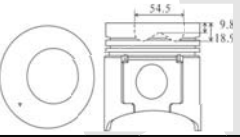

ENGINE TYPE Motortyp/ tipo de motor/ тип двигателя	LINER KIT Liner Kit/ camisas de los cilindros/ Лайнер комплект	CYL. LINER Zylinderlaufbuchse/ camisas de los cilindros/ втулка цилиндра	PISTON + RINGS Kolben + Ringe/ Pistón + Anillos/ поршень и кольца	PISTON SET Kolben Set/ Pistón Set/ поршневой	RINGS SET Ring Set/ Anillos Set/ кольца	PIN Pin/ Perno/ Пин																																					
J3 Tci 2,902 cc 4 cyl 97.1 mm Bore Ø		<table border="1"> <tr> <td></td> <td>Liner/ Sleeve</td> <td></td> </tr> <tr> <td>Length:</td> <td>168.5</td> <td></td> </tr> <tr> <td>Outside Ø:</td> <td>101.5</td> <td></td> </tr> <tr> <td>Flange Ø:</td> <td>107.25</td> <td></td> </tr> <tr> <td>Flange depth:</td> <td>5.0</td> <td>+0.7</td> </tr> </table>		Liner/ Sleeve		Length:	168.5		Outside Ø:	101.5		Flange Ø:	107.25		Flange depth:	5.0	+0.7	<table border="1"> <tr> <td colspan="2">Piston</td> </tr> <tr> <td>Length:</td> <td>84.0</td> </tr> <tr> <td>Comp. height:</td> <td>52.0</td> </tr> <tr> <td></td> <td>-6.1</td> </tr> <tr> <td></td> <td>-17.8</td> </tr> </table>	Piston		Length:	84.0	Comp. height:	52.0		-6.1		-17.8	Alfin and with oil gallery skirt MOS2 treated	<table border="1"> <tr> <td colspan="2">Rings</td> </tr> <tr> <td>Top:</td> <td>2.0</td> </tr> <tr> <td>2nd:</td> <td>2.0</td> </tr> <tr> <td>oil:</td> <td>3.0</td> </tr> </table>	Rings		Top:	2.0	2nd:	2.0	oil:	3.0	<table border="1"> <tr> <td>Ø:</td> <td>32.0</td> </tr> <tr> <td>Length:</td> <td>78.0</td> </tr> </table>	Ø:	32.0	Length:	78.0
			Liner/ Sleeve																																								
Length:	168.5																																										
Outside Ø:	101.5																																										
Flange Ø:	107.25																																										
Flange depth:	5.0	+0.7																																									
Piston																																											
Length:	84.0																																										
Comp. height:	52.0																																										
	-6.1																																										
	-17.8																																										
Rings																																											
Top:	2.0																																										
2nd:	2.0																																										
oil:	3.0																																										
Ø:	32.0																																										
Length:	78.0																																										
	Reference no.:	Reference no.:	Reference no.:	Reference no.:	Reference no.:																																						
	21111-4X300			23410-4X900 23410-4X910		23517-4X000																																					
NM-Motorservice Article no./ Artikelnummer/ Modelo número/ статья номер	NM-Motorservice Article no.:	NM-Motorservice Article no.:	NM-Motorservice Article no.:	NM-Motorservice Article no.:	NM-Motorservice Article no.:	NM-Motorservice Article no.:																																					
	LBS 26000 FB LBS 26000 SB	LB 26000 F (phosphated) LB 26000 S	KBS 26000 B	KB 26000 B	KR 26000	PB 26000																																					

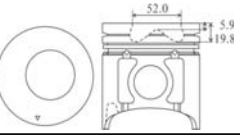

ENGINE TYPE Motortyp/ tipo de motor/ тип двигателя	LINER KIT Liner Kit/ camisas de los cilindros/ Лайнер комплект	CYL. LINER Zylinderlaufbuchse/ camisas de los cilindros/ втулка цилиндра	PISTON + RINGS Kolben + Ringe/ Pistón + Anillos/ поршень и кольца	PISTON SET Kolben Set/ Pistón Set/ поршневой	RINGS SET Ring Set/ Anillos Set/ кольца	PIN Pin/ Perno/ Пин																																					
J3 CRDi New 2,902 cc 4 cyl 97.1 mm Bore Ø		<table border="1"> <tr> <td></td> <td>Liner/ Sleeve</td> <td></td> </tr> <tr> <td>Length:</td> <td>168.5</td> <td></td> </tr> <tr> <td>Outside Ø:</td> <td>101.5</td> <td></td> </tr> <tr> <td>Flange Ø:</td> <td>107.25</td> <td></td> </tr> <tr> <td>Flange depth:</td> <td>5.0</td> <td>+0.7</td> </tr> </table>		Liner/ Sleeve		Length:	168.5		Outside Ø:	101.5		Flange Ø:	107.25		Flange depth:	5.0	+0.7	<table border="1"> <tr> <td colspan="2">Piston</td> </tr> <tr> <td>Length:</td> <td>84.1</td> </tr> <tr> <td>Comp. height:</td> <td>52.1</td> </tr> <tr> <td></td> <td>-4.2</td> </tr> <tr> <td></td> <td>-16.1</td> </tr> </table>	Piston		Length:	84.1	Comp. height:	52.1		-4.2		-16.1	Alfin and with oil gallery skirt MOS2 treated	<table border="1"> <tr> <td colspan="2">Rings</td> </tr> <tr> <td>Top:</td> <td>2.5</td> </tr> <tr> <td>2nd:</td> <td>2.0</td> </tr> <tr> <td>oil:</td> <td>3.0</td> </tr> </table>	Rings		Top:	2.5	2nd:	2.0	oil:	3.0	<table border="1"> <tr> <td>Ø:</td> <td>32.0</td> </tr> <tr> <td>Length:</td> <td>78.0</td> </tr> </table>	Ø:	32.0	Length:	78.0
			Liner/ Sleeve																																								
Length:	168.5																																										
Outside Ø:	101.5																																										
Flange Ø:	107.25																																										
Flange depth:	5.0	+0.7																																									
Piston																																											
Length:	84.1																																										
Comp. height:	52.1																																										
	-4.2																																										
	-16.1																																										
Rings																																											
Top:	2.5																																										
2nd:	2.0																																										
oil:	3.0																																										
Ø:	32.0																																										
Length:	78.0																																										
	Reference no.:	Reference no.:	Reference no.:	Reference no.:	Reference no.:																																						
	21111-4X300			23040-4X900 23040-4X910 23040-4X920		23517-4X000																																					
NM-Motorservice Article no./ Artikelnummer/ Modelo número/ статья номер	NM-Motorservice Article no.:	NM-Motorservice Article no.:	NM-Motorservice Article no.:	NM-Motorservice Article no.:	NM-Motorservice Article no.:	NM-Motorservice Article no.:																																					
	LBS 40450 FB LBS 40450 SB	LB 40450 F (phosphated) LB 40450 S	KBS 40450 B	KB 40450 B	KR 40450	PB 40450																																					

ENGINE TYPE Motortyp/ tipo de motor/ тип двигателя	LINER KIT Liner Kit/ camisas de los cilindros/ Лайнер комплект	CYL. LINER Zylinderlaufbuchse/ camisas de los cilindros/ втулка цилиндра			PISTON + RINGS Kolben + Ringe/ Pistón + Anillos/ поршень и кольца		PISTON SET Kolben Set/ Pistón Set/ поршневой	RINGS SET Ring Set/ Anillos Set/ кольца		PIN Pin/ Perno/ Пин
D4AE D4AL			Flanged	No flange	Piston			Rings		Ø : 34.0 Length: 84.0
		Length: Outside Ø: Flange Ø: Flange depth:	191.0 104.0 109.0 5.0	191.0 104.0	Length: Comp. height:	110.6 60.7 -10.2 -17.4				
3,298 cc 4 cyl 100.0 mm Bore Ø										
										
NM-Motorservice Article no./ Artikelnummer/ Modelo número/ статья номер	NM-Motorservice Article no.:	NM-Motorservice Article no.:			NM-Motorservice Article no.:		NM-Motorservice Article no.:	NM-Motorservice Article no.:		NM-Motorservice Article no.:
	LBS 44450 PA LBS 44450 SA	LB 44450 P LB 44450 S			KBS 44450 A		KB 44450 A	KR 44450		PB 44450

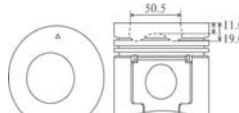
ENGINE TYPE Motortyp/ tipo de motor/ тип двигателя	LINER KIT Liner Kit/ camisas de los cilindros/ Лайнер комплект	CYL. LINER Zylinderlaufbuchse/ camisas de los cilindros/ втулка цилиндра			PISTON + RINGS Kolben + Ringe/ Pistón + Anillos/ поршень и кольца		PISTON SET Kolben Set/ Pistón Set/ поршневой	RINGS SET Ring Set/ Anillos Set/ кольца		PIN Pin/ Perno/ Пин
D4AF			Flanged	No flange	Piston			Rings		Ø : 34.0 Length: 84.0
		Length: Outside Ø: Flange Ø: Flange depth:	192.0 107.0 113.0 4.0	192.0 107.0	Length: Comp. height:	110.7 60.7 -9.8 -18.9				
K-1 3,568 cc 4 cyl 104.0 mm Bore Ø										
										
NM-Motorservice Article no./ Artikelnummer/ Modelo número/ статья номер	NM-Motorservice Article no.:	NM-Motorservice Article no.:			NM-Motorservice Article no.:		NM-Motorservice Article no.:	NM-Motorservice Article no.:		NM-Motorservice Article no.:
	LBS 40550 PA LBS 40550 SA	LB 40550 P LB 40550 S			KBS 40550 A		KB 40550 A	KR 40550		PB 40550

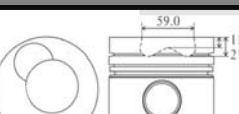

ENGINE TYPE Motortyp/ tipo de motor/ тип двигателя	LINER KIT Liner Kit/ camisas de los cilindros/ Лайнер комплект	CYL. LINER Zylinderlaufbuchse/ camisas de los cilindros/ втулка цилиндра			PISTON + RINGS Kolben + Ringe/ Pistón + Anillos/ поршень и кольца		PISTON SET Kolben Set/ Pistón Set/ поршневой	RINGS SET Ring Set/ Anillos Set/ кольца		PIN Pin/ Perno/ Пин
D4DA			Flanged	No flange	Piston		Alfin and with oil gallery	Rings		Ø : 36.0 Length: 88.0
		Length: Outside Ø: Flange Ø: Flange depth:	200.0 108.0 113.0 4.0	200.0 108.0	Length: Comp. height:	112.2 62.2 -5.9 -19.8				
HD65 HD72 (1998.10-2004.09) 3,907 cc 4 cyl 104.0 mm Bore Ø										
										
NM-Motorservice Article no./ Artikelnummer/ Modelo número/ статья номер	NM-Motorservice Article no.:	NM-Motorservice Article no.:			NM-Motorservice Article no.:		NM-Motorservice Article no.:	NM-Motorservice Article no.:		NM-Motorservice Article no.:
	LBS 40600 PB LBS 40600 SB	LB 40600 P LB 40600 S			KBS 40600 B		KB 40600 B	KR 40600		PB 40600



ENGINE TYPE Motortyp/ tipo de motor/ тип двигателя	LINER KIT Liner Kit/ camisas de los cilindros/ Лайнер комплект	CYL. LINER Zylinderlaufbuchse/ camisas de los cilindros/ втулка цилиндра		PISTON + RINGS Kolben + Ringe/ Pistón + Anillos/ поршень и кольца		PISTON SET Kolben Set/ Pistón Set/ поршневой	RINGS SET Ring Set/ Anillos Set/ кольца		PIN Pin/ Perno/ Пин	
D4AF New 3,568 cc 4 cyl 104.0 mm Bore Ø		Flanged	No flange	Piston			Rings		Ø : 34.0 Length: 84.0	
		Length: 192.0 Outside Ø: 107.0 Flange Ø: 113.0 Flange depth: 4.0	192.0 107.0	Length: 110.7 Comp. height: 60.7 -11.0 -19.0	Top: 3.0 2nd: 2.0 oil: 4.0					
		Reference no.:		Reference no.:	Reference no.:	Reference no.:	Reference no.:	Reference no.:		
		21131-41200			23410-41210 23411-41210	23040-41200 23040-46020	23517-41310			
NM-Motorservice Article no./ Artikelnummer/ Modelo número/ статья номер	NM-Motorservice Article no.:	NM-Motorservice Article no.:		NM-Motorservice Article no.:	NM-Motorservice Article no.:	NM-Motorservice Article no.:	NM-Motorservice Article no.:	NM-Motorservice Article no.:		
	LBS 40650 PA LBS 40650 SA	LB 40650 P LB 40650 S		KBS 40650 A	KB 40650 A	KR 40650	PB 40650			



ENGINE TYPE Motortyp/ tipo de motor/ тип двигателя	LINER KIT Liner Kit/ camisas de los cilindros/ Лайнер комплект	CYL. LINER Zylinderlaufbuchse/ camisas de los cilindros/ втулка цилиндра		PISTON + RINGS Kolben + Ringe/ Pistón + Anillos/ поршень и кольца		PISTON SET Kolben Set/ Pistón Set/ поршневой	RINGS SET Ring Set/ Anillos Set/ кольца		PIN Pin/ Perno/ Пин	
D6BR 5/8 TON TRUCK • AERO CITY • AERO TOWN 1998-2002 cc cyl mm Bore Ø		Liner/ Sleeve		Piston			Rings		Ø : 38.0 Length: 92.0	
		Length: 205.0 Outside Ø: 122.0 Flange Ø: 128.0 Flange depth: 8.0		Length: 116.1 Comp. height: 71.1 -11.8 -21.8	Top: 3.0 2nd: 2.5 oil: 4.0					
		Reference no.:		Reference no.:	Reference no.:	Reference no.:	Reference no.:	Reference no.:		
		21131-93000			23411-93002	23040-93000	23517-93032			
NM-Motorservice Article no./ Artikelnummer/ Modelo número/ статья номер	NM-Motorservice Article no.:	NM-Motorservice Article no.:		NM-Motorservice Article no.:	NM-Motorservice Article no.:	NM-Motorservice Article no.:	NM-Motorservice Article no.:	NM-Motorservice Article no.:		
	LBS 40700 FA	LB 40700 F (phosphated)		KBS 40700 A	KB 40700 A	KR 40700	PB 40700			



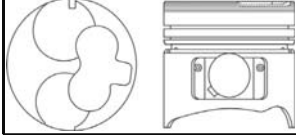

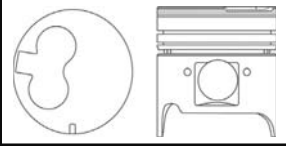

ENGINE TYPE Motortyp/ tipo de motor/ тип двигателя	LINER KIT Liner Kit/ camisas de los cilindros/ Лайнер комплект	CYL. LINER Zylinderlaufbuchse/ camisas de los cilindros/ втулка цилиндра			PISTON + RINGS Kolben + Ringe/ Pistón + Anillos/ поршень и кольца	PISTON SET Kolben Set/ Pistón Set/ поршневой	RINGS SET Ring Set/ Anillos Set/ кольца		PIN Pin/ Perno/ Пин
3KR1 1,422 cc 3 cyl 81.0 mm Bore Ø			Flanged	No flange	Piston		Rings		Ø : Length:
		Length: Outside Ø: Flange Ø: Flange depth:					Length: Comp. height:	Top: 2nd: oil:	
		Reference no.:				Reference no.:	Reference no.:	Reference no.:	
						8-94176-892-0	5-12121-029-0 8-94421-650-0		
NM-Motorservice Article no./ Artikelnummer/ Modelo número/ статья номер	NM-Motorservice Article no.:	NM-Motorservice Article no.:			NM-Motorservice Article no.:	NM-Motorservice Article no.:	NM-Motorservice Article no.:	NM-Motorservice Article no.:	NM-Motorservice Article no.:
	LBS 13700 PA LBS 13700 SA	LB 13700 P LB 13700 S			KBS 13700 A	KB 13700 A	KR 13700	PB 13700	

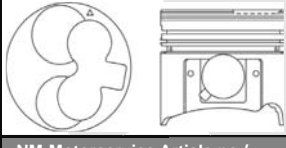

ENGINE TYPE Motortyp/ tipo de motor/ тип двигателя	LINER KIT Liner Kit/ camisas de los cilindros/ Лайнер комплект	CYL. LINER Zylinderlaufbuchse/ camisas de los cilindros/ втулка цилиндра			PISTON + RINGS Kolben + Ringe/ Pistón + Anillos/ поршень и кольца	PISTON SET Kolben Set/ Pistón Set/ поршневой	RINGS SET Ring Set/ Anillos Set/ кольца		PIN Pin/ Perno/ Пин
4EC1 also for OPEL CORSA A/B 1.5 TD 1,487 cc 4 cyl 76.0 mm Bore Ø			Flanged	No flange	Piston		Rings		Ø : Length:
		Length: Outside Ø: Flange Ø: Flange depth:	145.0 80.0 84.0 5.0	140.0 80.0			Length: Comp. height:	71.7 41.7 -1.6	
		Reference no.:				Reference no.:	Reference no.:	Reference no.:	
						8-94129-828-0	8-94144-187-0 8-94332-767-1 8-94342-490-0	8-94251-216-1	
NM-Motorservice Article no./ Artikelnummer/ Modelo número/ статья номер	NM-Motorservice Article no.:	NM-Motorservice Article no.:			NM-Motorservice Article no.:	NM-Motorservice Article no.:	NM-Motorservice Article no.:	NM-Motorservice Article no.:	NM-Motorservice Article no.:
	LBS 13750 PA LBS 13750 SA	LB 13750 P LB 13750 S			KBS 13750 A	KB 13750 A	KR 13750	PB 13750	

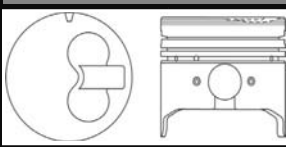

ENGINE TYPE Motortyp/ tipo de motor/ тип двигателя	LINER KIT Liner Kit/ camisas de los cilindros/ Лайнер комплект	CYL. LINER Zylinderlaufbuchse/ camisas de los cilindros/ втулка цилиндра			PISTON + RINGS Kolben + Ringe/ Pistón + Anillos/ поршень и кольца	PISTON SET Kolben Set/ Pistón Set/ поршневой	RINGS SET Ring Set/ Anillos Set/ кольца		PIN Pin/ Perno/ Пин
4EC1T also for OPEL CORSA A/B 1.5TD 1,487 cc 4 cyl 76.0 mm Bore Ø			Flanged	No flange	Piston		Rings		Ø : Length:
		Length: Outside Ø: Flange Ø: Flange depth:	145.0 80.0 84.0 5.0	140.0 80.0			Length: Comp. height:	71.7 41.7 -1.2	
		Reference no.:				Reference no.:	Reference no.:	Reference no.:	
						8-94149-276-4	8-94144-187-0 8-94332-767-1 8-94342-490-0	5-12251-007-0 8-94114-054-0	
NM-Motorservice Article no./ Artikelnummer/ Modelo número/ статья номер	NM-Motorservice Article no.:	NM-Motorservice Article no.:			NM-Motorservice Article no.:	NM-Motorservice Article no.:	NM-Motorservice Article no.:	NM-Motorservice Article no.:	NM-Motorservice Article no.:
	LBS 13800 PA LBS 13800 SA	LB 13800 P LB 13800 S			KBS 13800 A	KB 13800 A	KR 13800	PB 13800	

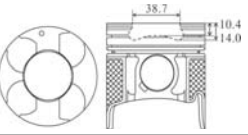

ENGINE TYPE Motortyp/ tipo de motor/ тип двигателя	LINER KIT Liner Kit/ camisas de los cilindros/ Лайнер комплект	CYL. LINER Zylinderlaufbuchse/ camisas de los cilindros/ втулка цилиндра		PISTON + RINGS Kolben + Ringe/ Pistón + Anillos/ поршень и кольца	PISTON SET Kolben Set/ Pistón Set/ поршневой	RINGS SET Ring Set/ Anillos Set/ кольца	PIN Pin/ Perno/ Пин	
4FE1 (1985-1995) 1,487 cc 4 cyl 76.3 mm Bore Ø			Flanged	No flange	Piston Length: 80.0 Comp. height: 45.0 -2.3	Rings		Ø: 25.0 Length: 63.0
		Length: 80.0 Outside Ø: 45.0 Flange Ø: Flange depth: -2.3				Top: 2.0 2nd: 2.0 oil: 4.0		
		Reference no.:			Reference no.:	Reference no.:	Reference no.:	
						8-94619-747-1 8-94619-752-1 8-94459-384-0 8-94463-219-0 8-94463-220-0 8-94463-229-0 8-94463-230-0 8-94463-237-0 8-94463-238-0	8-94169-748-0 8-94169-753-0 8-94459-462-0 8-94463-221-0 8-94463-222-0 8-94463-231-0 8-94463-232-0 8-94463-239-0 8-94463-240-0	5-12251-007-0 8-94114-054-0
NM-Motorservice Article no./ Artikelnummer/ Modelo número/ статья номер	NM-Motorservice Article no.:	NM-Motorservice Article no.:		NM-Motorservice Article no.:	NM-Motorservice Article no.:	NM-Motorservice Article no.:	NM-Motorservice Article no.:	
	LBS 13850 P LBS 13850 S	LB 13850 P LB 13850 S		KBS 13850	KB 13850	KR 13850	PB 13850	

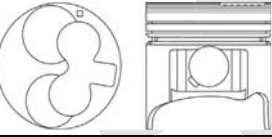

ENGINE TYPE Motortyp/ tipo de motor/ тип двигателя	LINER KIT Liner Kit/ camisas de los cilindros/ Лайнер комплект	CYL. LINER Zylinderlaufbuchse/ camisas de los cilindros/ втулка цилиндра		PISTON + RINGS Kolben + Ringe/ Pistón + Anillos/ поршень и кольца	PISTON SET Kolben Set/ Pistón Set/ поршневой	RINGS SET Ring Set/ Anillos Set/ кольца	PIN Pin/ Perno/ Пин	
4EE1T also for OPEL 17 TD 1,686 cc 4 cyl 79.0 mm Bore Ø			Flanged	No flange	Piston Length: 69.7 Comp. height: 39.7 -0.5 -1.5	Rings		Ø: 27.0 Length: 64.0
		Length: 144.0 Outside Ø: 83.0 Flange Ø: 87.0 Flange depth: 2.0	144.0	83.0		Top: 2.0 2nd: 1.5 oil: 3.0		
		LB 13900 S - 1:			Reference no.:	Reference no.:	Reference no.:	
		Length: 144.0 Outside Ø: 83.0 Flange Ø: 87.0 Flange depth: 2.0			8-97043-772-0 8-97043-773-0	8-94381-709-0 8-94381-709-1	8-94369-904-0	
NM-Motorservice Article no./ Artikelnummer/ Modelo número/ статья номер	NM-Motorservice Article no.:	NM-Motorservice Article no.:		NM-Motorservice Article no.:	NM-Motorservice Article no.:	NM-Motorservice Article no.:	NM-Motorservice Article no.:	
	LBS 13900 PA LBS 13900 SA	LB 13900 P LB 13900 S LB 13900 S - 1		KBS 13900 A	KB 13900 A	KR 13900	PB 13900	

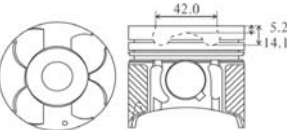

ENGINE TYPE Motortyp/ tipo de motor/ тип двигателя	LINER KIT Liner Kit/ camisas de los cilindros/ Лайнер комплект	CYL. LINER Zylinderlaufbuchse/ camisas de los cilindros/ втулка цилиндра		PISTON + RINGS Kolben + Ringe/ Pistón + Anillos/ поршень и кольца	PISTON SET Kolben Set/ Pistón Set/ поршневой	RINGS SET Ring Set/ Anillos Set/ кольца	PIN Pin/ Perno/ Пин	
4EE1 1,686 cc 4 cyl 79.0 mm Bore Ø			Flanged	No flange	Piston Length: 79.7 Comp. height: 39.7 -1.7	Rings		Ø: 25.0 Length: 60.0
		Length: 144.0 Outside Ø: 83.0 Flange Ø: 87.0 Flange depth: 2.0	144.0	83.0		Top: 2.0 2nd: 1.5 oil: 3.0		
		LB 13950 S - 1:			Reference no.:	Reference no.:	Reference no.:	
		Length: 137.0 Outside Ø: 82.0 Flange Ø: 84.0 Flange depth: 4.0			8-97129-437-0 8-97129-437-1 8-97129-437-2	8-94381-709-0 8-94381-709-1	8-94114-054-0	
NM-Motorservice Article no./ Artikelnummer/ Modelo número/ статья номер	NM-Motorservice Article no.:	NM-Motorservice Article no.:		NM-Motorservice Article no.:	NM-Motorservice Article no.:	NM-Motorservice Article no.:	NM-Motorservice Article no.:	
	LBS 13950 PA LBS 13950 SA	LB 13950 P LB 13950 S LB 13950 S - 1		KBS 13950 A	KB 13950 A	KR 13950	PB 13950	

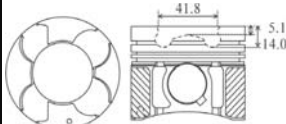

ENGINE TYPE Motortyp/ tipo de motor/ тип двигателя	LINER KIT Liner Kit/ camisas de los cilindros/ Лайнер комплект	CYL. LINER Zylinderlaufbuchse/ camisas de los cilindros/ втулка цилиндра			PISTON + RINGS Kolben + Ringe/ Pistón + Anillos/ поршень и кольца		PISTON SET Kolben Set/ Pistón Set/ поршневой	RINGS SET Ring Set/ Anillos Set/ кольца		PIN Pin/ Perno/ Пин
4EE1T New also for OPEL Y 17 DT/L 1,686 cc 4 cyl 79.0 mm Bore Ø			Flanged	No flange	Piston		Alfin skirt MOS2 treated	Rings		
		Length: Outside Ø: Flange Ø: Flange depth:	144.0 83.0 87.0 2.0	144.0 83.0	Length: Comp. height:	84.0 39.7 -10.4 -14.0		Top: 2nd: oil:	2.0 1.5 3.0	Ø: Length:
		LB 14000 S - 1:					Reference no.:	Reference no.:	Reference no.:	
		Length: Outside Ø: Flange Ø: Flange depth:	137.0 82.0 84.0 4.0				8-97188-927-2	8-94381-709-0 8-94381-709-1	8-94369-904-0	
NM-Motorservice Article no./ Artikelnummer/ Modelo número/ статья номер	NM-Motorservice Article no.:	NM-Motorservice Article no.:			NM-Motorservice Article no.:		NM-Motorservice Article no.:	NM-Motorservice Article no.:		NM-Motorservice Article no.:
	LBS 37150 PA LBS 37150 SA	LB 37150 P LB 37150 S LB 37150 S - 1			KBS 37150 A		KB 37150 A	KR 37150		PB 37150

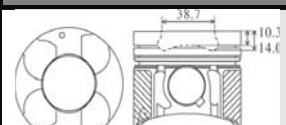

ENGINE TYPE Motortyp/ tipo de motor/ тип двигателя	LINER KIT Liner Kit/ camisas de los cilindros/ Лайнер комплект	CYL. LINER Zylinderlaufbuchse/ camisas de los cilindros/ втулка цилиндра			PISTON + RINGS Kolben + Ringe/ Pistón + Anillos/ поршень и кольца		PISTON SET Kolben Set/ Pistón Set/ поршневой	RINGS SET Ring Set/ Anillos Set/ кольца		PIN Pin/ Perno/ Пин
4EE1 New 1,686 cc 4 cyl 79.0 mm Bore Ø			Flanged	No flange	Piston			Rings		
		Length: Outside Ø: Flange Ø: Flange depth:	144.0 83.0 87.0 2.0	144.0 83.0	Length: Comp. height:	79.7 39.7 -1.7		Top: 2nd: oil:	2.0 1.5 3.0	Ø: Length:
		LB 14050 S - 1:					Reference no.:	Reference no.:	Reference no.:	
		Length: Outside Ø: Flange Ø: Flange depth:	137.0 82.0 84.0 4.0				8-97142-379-0	8-94381-709-0 8-94381-709-1	8-94114-054-0	
NM-Motorservice Article no./ Artikelnummer/ Modelo número/ статья номер	NM-Motorservice Article no.:	NM-Motorservice Article no.:			NM-Motorservice Article no.:		NM-Motorservice Article no.:	NM-Motorservice Article no.:		NM-Motorservice Article no.:
	LBS 14050 PA LBS 14050 SA	LB 14050 P LB 14050 S LB 14050 S - 1			KBS 14050 A		KB 14050 A	KR 14050		PB 14050

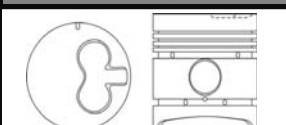

ENGINE TYPE Motortyp/ tipo de motor/ тип двигателя	LINER KIT Liner Kit/ camisas de los cilindros/ Лайнер комплект	CYL. LINER Zylinderlaufbuchse/ camisas de los cilindros/ втулка цилиндра			PISTON + RINGS Kolben + Ringe/ Pistón + Anillos/ поршень и кольца		PISTON SET Kolben Set/ Pistón Set/ поршневой	RINGS SET Ring Set/ Anillos Set/ кольца		PIN Pin/ Perno/ Пин
4EE1T New also for OPEL Z 17 DTL 1,686 cc 4 cyl 79.0 mm Bore Ø			Flanged	No flange	Piston		Alfin skirt MOS2 treated	Rings		
		Length: Outside Ø: Flange Ø: Flange depth:	144.0 83.0 87.0 2.0	144.0 83.0	Length: Comp. height:	74.0 39.8 -5.2 -14.1		Top: 2nd: oil:	2.0 1.5 3.0	Ø: Length:
		LB 14100 S - 1:					Reference no.:	Reference no.:	Reference no.:	
		Length: Outside Ø: Flange Ø: Flange depth:	137.0 82.0 84.0 4.0				8-97300-110-0 S623199 S623200 S623201 S623283 S623284 S623285	8-94381-709-0 8-94381-709-1	8-94369-904-0	
NM-Motorservice Article no./ Artikelnummer/ Modelo número/ статья номер	NM-Motorservice Article no.:	NM-Motorservice Article no.:			NM-Motorservice Article no.:		NM-Motorservice Article no.:	NM-Motorservice Article no.:		NM-Motorservice Article no.:
	LBS 14100 PA LBS 14100 SA	LB 14100 P LB 14100 S LB 14100 S - 1			KBS 14100 A		KB 14100 A	KR 14100		PB 14100



ENGINE TYPE Motortyp/ tipo de motor/ тип двигателя	LINER KIT Liner Kit/ camisas de los cilindros/ Лайнер комплект	CYL. LINER Zylinderlaufbuchse/ camisas de los cilindros/ втулка цилиндра	PISTON + RINGS Kolben + Ringe/ Pistón + Anillos/ поршень и кольца	PISTON SET Kolben Set/ Pistón Set/ поршневой	RINGS SET Ring Set/ Anillos Set/ кольца	PIN Pin/ Perno/ Пин																																	
4EE2 CDTi also for OPEL Z 17 DTH 1,686 cc 4 cyl 79.0 mm Bore Ø		<table border="1"> <tr> <td></td> <td>Flanged</td> <td>No flange</td> </tr> <tr> <td>Length:</td> <td>144.0</td> <td>144.0</td> </tr> <tr> <td>Outside Ø:</td> <td>83.0</td> <td>83.0</td> </tr> <tr> <td>Flange Ø:</td> <td>87.0</td> <td></td> </tr> <tr> <td>Flange depth:</td> <td>2.0</td> <td></td> </tr> </table>		Flanged	No flange	Length:	144.0	144.0	Outside Ø:	83.0	83.0	Flange Ø:	87.0		Flange depth:	2.0		<table border="1"> <tr> <td>Length:</td> <td>64.7</td> </tr> <tr> <td>Comp. height:</td> <td>39.7</td> </tr> <tr> <td></td> <td>-5.1</td> </tr> <tr> <td></td> <td>-14.0</td> </tr> </table>	Length:	64.7	Comp. height:	39.7		-5.1		-14.0	Alfin and with oil gallery skirt MOS2 treated	<table border="1"> <tr> <td>Top:</td> <td>2.0</td> <td rowspan="2">Ø:</td> <td rowspan="2">27.0</td> </tr> <tr> <td>2nd:</td> <td>1.5</td> </tr> <tr> <td>oil:</td> <td>3.0</td> <td>Length:</td> <td>64.0</td> </tr> </table>	Top:	2.0	Ø:	27.0	2nd:	1.5	oil:	3.0	Length:	64.0	
			Flanged	No flange																																			
Length:	144.0	144.0																																					
Outside Ø:	83.0	83.0																																					
Flange Ø:	87.0																																						
Flange depth:	2.0																																						
Length:	64.7																																						
Comp. height:	39.7																																						
	-5.1																																						
	-14.0																																						
Top:	2.0	Ø:	27.0																																				
2nd:	1.5																																						
oil:	3.0	Length:	64.0																																				
		LB 14150 S - 1: <table border="1"> <tr> <td>Length:</td> <td>137.0</td> <td></td> </tr> <tr> <td>Outside Ø:</td> <td>82.0</td> <td></td> </tr> <tr> <td>Flange Ø:</td> <td>84.0</td> <td></td> </tr> <tr> <td>Flange depth:</td> <td>4.0</td> <td></td> </tr> </table>	Length:	137.0		Outside Ø:	82.0		Flange Ø:	84.0		Flange depth:	4.0			Reference no.: 8-97329-296-1	Reference no.: 8-94381-709-0 8-94381-709-1	Reference no.: 8-94369-904-0																					
Length:	137.0																																						
Outside Ø:	82.0																																						
Flange Ø:	84.0																																						
Flange depth:	4.0																																						
NM-Motorservice Article no./ Artikelnummer/ Modelo número/ статья номер	NM-Motorservice Article no.:	NM-Motorservice Article no.:	NM-Motorservice Article no.:	NM-Motorservice Article no.:	NM-Motorservice Article no.:	NM-Motorservice Article no.:																																	
	LBS 14150 PB LBS 14150 SB	LB 14150 P LB 14150 S LB 14150 S - 1	KBS 14150 B	KB 14150 B	KR 14150	PB 14150																																	

ENGINE TYPE Motortyp/ tipo de motor/ тип двигателя	LINER KIT Liner Kit/ camisas de los cilindros/ Лайнер комплект	CYL. LINER Zylinderlaufbuchse/ camisas de los cilindros/ втулка цилиндра	PISTON + RINGS Kolben + Ringe/ Pistón + Anillos/ поршень и кольца	PISTON SET Kolben Set/ Pistón Set/ поршневой	RINGS SET Ring Set/ Anillos Set/ кольца	PIN Pin/ Perno/ Пин																																	
4EE2 also for OPEL Y 17 DT/L 1,686 cc 4 cyl 79.0 mm Bore Ø		<table border="1"> <tr> <td></td> <td>Flanged</td> <td>No flange</td> </tr> <tr> <td>Length:</td> <td>144.0</td> <td>144.0</td> </tr> <tr> <td>Outside Ø:</td> <td>83.0</td> <td>83.0</td> </tr> <tr> <td>Flange Ø:</td> <td>87.0</td> <td></td> </tr> <tr> <td>Flange depth:</td> <td>2.0</td> <td></td> </tr> </table>		Flanged	No flange	Length:	144.0	144.0	Outside Ø:	83.0	83.0	Flange Ø:	87.0		Flange depth:	2.0		<table border="1"> <tr> <td>Length:</td> <td>64.7</td> </tr> <tr> <td>Comp. height:</td> <td>39.7</td> </tr> <tr> <td></td> <td>-5.1</td> </tr> <tr> <td></td> <td>-14.0</td> </tr> </table>	Length:	64.7	Comp. height:	39.7		-5.1		-14.0	Alfin skirt MOS2 treated	<table border="1"> <tr> <td>Top:</td> <td>2.0</td> <td rowspan="2">Ø:</td> <td rowspan="2"></td> </tr> <tr> <td>2nd:</td> <td>1.5</td> </tr> <tr> <td>oil:</td> <td>3.0</td> <td>Length:</td> <td>64.0</td> </tr> </table>	Top:	2.0	Ø:		2nd:	1.5	oil:	3.0	Length:	64.0	
			Flanged	No flange																																			
Length:	144.0	144.0																																					
Outside Ø:	83.0	83.0																																					
Flange Ø:	87.0																																						
Flange depth:	2.0																																						
Length:	64.7																																						
Comp. height:	39.7																																						
	-5.1																																						
	-14.0																																						
Top:	2.0	Ø:																																					
2nd:	1.5																																						
oil:	3.0	Length:	64.0																																				
		LB 14200 S - 1: <table border="1"> <tr> <td>Length:</td> <td>137.0</td> <td></td> </tr> <tr> <td>Outside Ø:</td> <td>82.0</td> <td></td> </tr> <tr> <td>Flange Ø:</td> <td>84.0</td> <td></td> </tr> <tr> <td>Flange depth:</td> <td>4.0</td> <td></td> </tr> </table>	Length:	137.0		Outside Ø:	82.0		Flange Ø:	84.0		Flange depth:	4.0			Reference no.: 	Reference no.: 8-94381-709-0 8-94381-709-1	Reference no.: 8-94369-904-0																					
Length:	137.0																																						
Outside Ø:	82.0																																						
Flange Ø:	84.0																																						
Flange depth:	4.0																																						
NM-Motorservice Article no./ Artikelnummer/ Modelo número/ статья номер	NM-Motorservice Article no.:	NM-Motorservice Article no.:	NM-Motorservice Article no.:	NM-Motorservice Article no.:	NM-Motorservice Article no.:	NM-Motorservice Article no.:																																	
	LBS 14200 PA LBS 14200 SA	LB 14200 P LB 14200 S LB 14200 S - 1	KBS 14200 A	KB 14200 A	KR 14200	PB 14200																																	

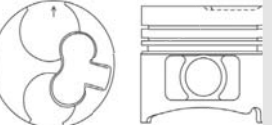
ENGINE TYPE Motortyp/ tipo de motor/ тип двигателя	LINER KIT Liner Kit/ camisas de los cilindros/ Лайнер комплект	CYL. LINER Zylinderlaufbuchse/ camisas de los cilindros/ втулка цилиндра	PISTON + RINGS Kolben + Ringe/ Pistón + Anillos/ поршень и кольца	PISTON SET Kolben Set/ Pistón Set/ поршневой	RINGS SET Ring Set/ Anillos Set/ кольца	PIN Pin/ Perno/ Пин																																							
C221 2,207 cc 4 cyl 83.0 mm Bore Ø		<table border="1"> <tr> <td></td> <td>Liner/ Sleeve</td> <td></td> </tr> <tr> <td>Length:</td> <td>174.5</td> <td></td> </tr> <tr> <td>Outside Ø:</td> <td>86.0</td> <td></td> </tr> <tr> <td>Flange Ø:</td> <td>92.0</td> <td></td> </tr> <tr> <td>Flange depth:</td> <td>1.4</td> <td></td> </tr> </table>		Liner/ Sleeve		Length:	174.5		Outside Ø:	86.0		Flange Ø:	92.0		Flange depth:	1.4		<table border="1"> <tr> <td>Length:</td> <td>95.5</td> </tr> <tr> <td>Comp. height:</td> <td>48.5</td> </tr> <tr> <td></td> <td>-3.0</td> </tr> </table>	Length:	95.5	Comp. height:	48.5		-3.0		<table border="1"> <tr> <td>Top:</td> <td>2.0</td> <td rowspan="2">Ø:</td> <td rowspan="2">25.0</td> </tr> <tr> <td>2nd:</td> <td>2.0</td> </tr> <tr> <td>3rd:</td> <td>2.0</td> <td>Length:</td> <td>72.5</td> </tr> <tr> <td>1st oil:</td> <td>5.0</td> <td></td> <td></td> </tr> <tr> <td>2nd oil:</td> <td>5.0</td> <td></td> <td></td> </tr> </table>	Top:	2.0	Ø:	25.0	2nd:	2.0	3rd:	2.0	Length:	72.5	1st oil:	5.0			2nd oil:	5.0			
			Liner/ Sleeve																																										
Length:	174.5																																												
Outside Ø:	86.0																																												
Flange Ø:	92.0																																												
Flange depth:	1.4																																												
Length:	95.5																																												
Comp. height:	48.5																																												
	-3.0																																												
Top:	2.0	Ø:	25.0																																										
2nd:	2.0																																												
3rd:	2.0	Length:	72.5																																										
1st oil:	5.0																																												
2nd oil:	5.0																																												
		Reference no.: 9-11261-253-0 9-11261-253-1		Reference no.: 5-12111-065-0 9-12111-646-0	Reference no.: 5-12121-013-0 5-12121-014-0 5-12181-015-0 9-12181-122-0	Reference no.: 9-12251-038-0 9-12251-048-0 9-12251-061-0																																							
NM-Motorservice Article no./ Artikelnummer/ Modelo número/ статья номер	NM-Motorservice Article no.:	NM-Motorservice Article no.:	NM-Motorservice Article no.:	NM-Motorservice Article no.:	NM-Motorservice Article no.:	NM-Motorservice Article no.:																																							
	LBS 14250 C	LB 14250 C	KBS 14250	KB 14250	KR 14250	PB 14250																																							

ENGINE TYPE Motortyp/ tipo de motor/ тип двигателя	LINER KIT Liner Kit/ camisas de los cilindros/ Лайнер комплект	CYL. LINER Zylinderlaufbuchse/ camisas de los cilindros/ втулка цилиндра			PISTON + RINGS Kolben + Ringe/ Pistón + Anillos/ поршень и кольца		PISTON SET Kolben Set/ Pistón Set/ поршневой	RINGS SET Ring Set/ Anillos Set/ кольца		PIN Pin/ Perno/ Пин
4FB1 1,817 cc 4 cyl 84.0 mm Bore Ø			Flanged	No flange	Piston			Rings		
		Length: Outside Ø: Flange Ø: Flange depth:	172.0 88.0 92.0 4.0	150.0 88.0	Length: Comp. height:	74.8 44.7 -1.8		Top: 2nd: oil:	2.5 2.0 4.0	
		Reference no.:					Reference no.:	Reference no.:	Reference no.:	
		5-11261-119-0					8-94201-492-0 8-94228-886-2 8-94235-962-0	8-94139-973-0 8-94224-221-0	5-12271-007-0	
NM-Motorservice Article no./ Artikelnummer/ Modelo número/ статья номер	NM-Motorservice Article no.:	NM-Motorservice Article no.:			NM-Motorservice Article no.:		NM-Motorservice Article no.:	NM-Motorservice Article no.:	NM-Motorservice Article no.:	
	LBS 14300 P LBS 14300 S	LB 14300 P LB 14300 S			KBS 14300		KB 14300	KR 14300	PB 14300	

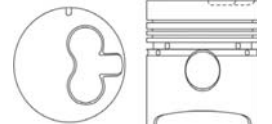

ENGINE TYPE Motortyp/ tipo de motor/ тип двигателя	LINER KIT Liner Kit/ camisas de los cilindros/ Лайнер комплект	CYL. LINER Zylinderlaufbuchse/ camisas de los cilindros/ втулка цилиндра			PISTON + RINGS Kolben + Ringe/ Pistón + Anillos/ поршень и кольца		PISTON SET Kolben Set/ Pistón Set/ поршневой	RINGS SET Ring Set/ Anillos Set/ кольца		PIN Pin/ Perno/ Пин
4FC1 1,995 cc 4 cyl 84.0 mm Bore Ø			Flanged	No flange	Piston			Rings		
		Length: Outside Ø: Flange Ø: Flange depth:	172.0 88.0 92.0 4.0	150.0 88.0	Length: Comp. height:	76.6 46.6 -2.2		Top: 2nd: oil:	2.5 2.0 4.0	
		Reference no.:					Reference no.:	Reference no.:	Reference no.:	
		5-11261-119-0					8-94111-655-1 8-94228-887-0 8-94228-887-1	8-94139-973-0 8-94224-221-0	5-12271-007-0	
NM-Motorservice Article no./ Artikelnummer/ Modelo número/ статья номер	NM-Motorservice Article no.:	NM-Motorservice Article no.:			NM-Motorservice Article no.:		NM-Motorservice Article no.:	NM-Motorservice Article no.:	NM-Motorservice Article no.:	
	LBS 14350 P LBS 14350 S	LB 14350 P LB 14350 S			KBS 14350		KB 14350	KR 14350	PB 14350	



ENGINE TYPE Motortyp/ tipo de motor/ тип двигателя	LINER KIT Liner Kit/ camisas de los cilindros/ Лайнер комплект	CYL. LINER Zylinderlaufbuchse/ camisas de los cilindros/ втулка цилиндра			PISTON + RINGS Kolben + Ringe/ Pistón + Anillos/ поршень и кольца		PISTON SET Kolben Set/ Pistón Set/ поршневой	RINGS SET Ring Set/ Anillos Set/ кольца		PIN Pin/ Perno/ Пин
C240 4 Rings Early 2,369 cc 4 cyl 86.0 mm Bore Ø	C = chromed S = cast iron		chrome	cast iron	Piston			Rings		
		Length: Outside Ø: Flange Ø: Flange depth:	178.5 88.0 94.0 0.9	178.0 90.1 94.0 4.0	Length: Comp. height:	95.5 51.5 -3.0		Top: 2nd: 3rd: oil:	2.0 2.0 2.0 5.0	
		Reference no.:					Reference no.:	Reference no.:	Reference no.:	
		9-11261-230-0 9-11261-230-1					5-12111-064-0 9-12111-813-0 5-12411-064-0	5-12121-007-0 5-12181-027-0 5-12181-028-0 9-12181-603-0 9-12181-605-0	9-12251-062-0	
NM-Motorservice Article no./ Artikelnummer/ Modelo número/ статья номер	NM-Motorservice Article no.:	NM-Motorservice Article no.:			NM-Motorservice Article no.:		NM-Motorservice Article no.:	NM-Motorservice Article no.:	NM-Motorservice Article no.:	
	LBS 14400 C LBS 14400 S	LB 14400 C (chromed) LB 14400 S (cast iron)			KBS 14400		KB 14400	KR 14400	PB 14400	

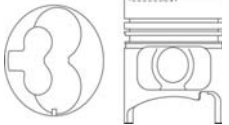

ENGINE TYPE Motortyp/ tipo de motor/ тип двигателя	LINER KIT Liner Kit/ camisas de los cilindros/ Лайнер комплект	CYL. LINER Zylinderlaufbuchse/ camisas de los cilindros/ втулка цилиндра		PISTON + RINGS Kolben + Ringe/ Pistón + Anillos/ поршень и кольца		PISTON SET Kolben Set/ Pistón Set/ поршневой	RINGS SET Ring Set/ Anillos Set/ кольца		PIN Pin/ Perno/ Пин	
C240 4 Rings 2,369 cc 4 cyl 86.0 mm Bore Ø	C = chromed S = cast iron		chrome	cast iron	Piston		Rings		Ø: Length:	27.0 72.2
		Length: Outside Ø: Flange Ø: Flange depth:	178.5 88.0 94.0 0.9	178.0 90.1 94.0 4.0	Length: Comp. height:	95.5 51.5 -3.0	Top: 2nd: 3rd: oil:	2.0 2.0 2.0 5.0		
		Reference no.:				Reference no.:	Reference no.:	Reference no.:		
		9-11261-230-0 9-11261-230-1				5-12111-119-0 5-12111-137-0 5-12111-202-0 5-12111-203-0	5-12121-007-0 5-12181-027-0 5-12181-028-0 9-12181-603-0 9-12181-605-0	9-12251-062-0		
NM-Motorservice Article no./ Artikelnummer/ Modelo número/ статья номер	NM-Motorservice Article no.:	NM-Motorservice Article no.:		NM-Motorservice Article no.:		NM-Motorservice Article no.:	NM-Motorservice Article no.:	NM-Motorservice Article no.:		
	LBS 14450 C LBS 14450 S	LB 14450 C (chromed) LB 14450 S (cast iron)		KBS 14450		KB 14450	KR 14450	PB 14450		

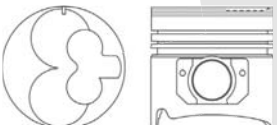

ENGINE TYPE Motortyp/ tipo de motor/ тип двигателя	LINER KIT Liner Kit/ camisas de los cilindros/ Лайнер комплект	CYL. LINER Zylinderlaufbuchse/ camisas de los cilindros/ втулка цилиндра		PISTON + RINGS Kolben + Ringe/ Pistón + Anillos/ поршень и кольца		PISTON SET Kolben Set/ Pistón Set/ поршневой	RINGS SET Ring Set/ Anillos Set/ кольца		PIN Pin/ Perno/ Пин	
C190 4 Rings 1,951 cc 4 cyl 86.0 mm Bore Ø	C = chromed S = cast iron		chrome	cast iron	Piston		Rings		Ø: Length:	27.0 72.2
		Length: Outside Ø: Flange Ø: Flange depth:	163.3 88.0 94.0 0.9	163.0 90.1 94.0 4.0	Length: Comp. height:	95.5 51.5 -3.0	Top: 2nd: 3rd: oil:	2.0 2.0 2.0 5.0		
		Reference no.:				Reference no.:	Reference no.:	Reference no.:		
		9-11261-224-0 9-11261-224-1				5-12111-119-0 5-12111-137-0 5-12111-202-0 5-12111-203-0	5-12121-007-0 5-12181-027-0 5-12181-028-0 9-12181-603-0 9-12181-605-0	9-12251-062-0		
NM-Motorservice Article no./ Artikelnummer/ Modelo número/ статья номер	NM-Motorservice Article no.:	NM-Motorservice Article no.:		NM-Motorservice Article no.:		NM-Motorservice Article no.:	NM-Motorservice Article no.:	NM-Motorservice Article no.:		
	LBS 14500 C LBS 14500 S	LB 14500 C (chromed) LB 14500 S (cast iron)		KBS 14500		KB 14500	KR 14500	PB 14500		

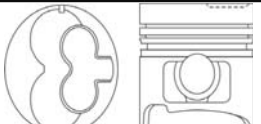

ENGINE TYPE Motortyp/ tipo de motor/ тип двигателя	LINER KIT Liner Kit/ camisas de los cilindros/ Лайнер комплект	CYL. LINER Zylinderlaufbuchse/ camisas de los cilindros/ втулка цилиндра		PISTON + RINGS Kolben + Ringe/ Pistón + Anillos/ поршень и кольца		PISTON SET Kolben Set/ Pistón Set/ поршневой	RINGS SET Ring Set/ Anillos Set/ кольца		PIN Pin/ Perno/ Пин	
C240 3 Rings 2,369 cc 4 cyl 86.0 mm Bore Ø	C = chromed S = cast iron		chrome	cast iron	Piston		Rings		Ø: Length:	27.0 68.0
		Length: Outside Ø: Flange Ø: Flange depth:	178.5 88.0 94.0 0.9	178.0 90.1 94.0 4.0	Length: Comp. height:	96.7 51.7 -1.9	Top: 2nd: oil:	2.5 2.0 5.0		
		Reference no.:				Reference no.:	Reference no.:	Reference no.:		
		9-11261-230-0 9-11261-230-1				5-12111-225-0 5-12111-226-0	5-12121-021-0 8-94104-949-0	5-12251-005-0 5-12251-007-0 9-12251-005-0		
NM-Motorservice Article no./ Artikelnummer/ Modelo número/ статья номер	NM-Motorservice Article no.:	NM-Motorservice Article no.:		NM-Motorservice Article no.:		NM-Motorservice Article no.:	NM-Motorservice Article no.:	NM-Motorservice Article no.:		
	LBS 14550 C LBS 14550 S	LB 14550 C (chromed) LB 14550 S (cast iron)		KBS 14550		KB 14550	KR 14550	PB 14550		

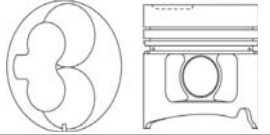

ENGINE TYPE Motortyp/ tipo de motor/ тип двигателя	LINER KIT Liner Kit/ camisas de los cilindros/ Лайнер комплект	CYL. LINER Zylinderlaufbuchse/ camisas de los cilindros/ втулка цилиндра			PISTON + RINGS Kolben + Ringe/ Pistón + Anillos/ поршень и кольца		PISTON SET Kolben Set/ Pistón Set/ поршневой	RINGS SET Ring Set/ Anillos Set/ кольца		PIN Pin/ Perno/ Пин
C190 3 Rings 1,951 cc 4 cyl 86.0 mm Bore Ø	C = chromed S = cast iron		chrome	cast iron	Piston			Rings		Ø : 27.0 Length: 68.0
		Length: 163.3 Outside Ø: 88.0 Flange Ø: 94.0 Flange depth: 0.9	163.0 90.1 94.0 4.0	Length: 96.7 Comp. height: 51.7 -1.9	Top: 2.5 2nd: 2.0 oil: 5.0					
		Reference no.:			Reference no.:		Reference no.:	Reference no.:		Reference no.:
		9-11261-224-0 9-11261-224-1			5-12111-225-0 5-12111-226-0		5-12121-021-0 8-94104-949-0	5-12251-005-0 5-12251-007-0 9-12251-005-0		
NM-Motorservice Article no./ Artikelnummer/ Modelo número/ статья номер	NM-Motorservice Article no.:	NM-Motorservice Article no.:			NM-Motorservice Article no.:		NM-Motorservice Article no.:	NM-Motorservice Article no.:		NM-Motorservice Article no.:
	LBS 14600 C LBS 14600 S	LB 14600 C (chromed) LB 14600 S (cast iron)			KBS 14600		KB 14600	KR 14600		PB 14600

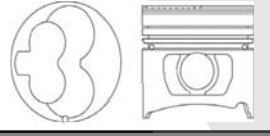

ENGINE TYPE Motortyp/ tipo de motor/ тип двигателя	LINER KIT Liner Kit/ camisas de los cilindros/ Лайнер комплект	CYL. LINER Zylinderlaufbuchse/ camisas de los cilindros/ втулка цилиндра			PISTON + RINGS Kolben + Ringe/ Pistón + Anillos/ поршень и кольца		PISTON SET Kolben Set/ Pistón Set/ поршневой	RINGS SET Ring Set/ Anillos Set/ кольца		PIN Pin/ Perno/ Пин
C240 3 Rings New 2,369 cc 4 cyl 86.0 mm Bore Ø	C = chromed S = cast iron		chrome	cast iron	Piston			Rings		Ø : 27.0 Length: 68.0
		Length: 178.5 Outside Ø: 88.0 Flange Ø: 94.0 Flange depth: 0.9	178.0 90.1 94.0 4.0	Length: 84.5 Comp. height: 51.5 -0.3 -2.5	Top: 2.5 2nd: 2.0 oil: 5.0					
		Reference no.:			Reference no.:		Reference no.:	Reference no.:		Reference no.:
		9-11261-230-0 9-11261-230-1			8-94326-225-0		5-12121-021-0 8-94104-949-0	5-12251-005-0 5-12251-007-0 9-12251-005-0		
NM-Motorservice Article no./ Artikelnummer/ Modelo número/ статья номер	NM-Motorservice Article no.:	NM-Motorservice Article no.:			NM-Motorservice Article no.:		NM-Motorservice Article no.:	NM-Motorservice Article no.:		NM-Motorservice Article no.:
	LBS 14650 CA LBS 14650 SA	LB 14650 C (chromed) LB 14650 S (cast iron)			KBS 14650 A		KB 14650 A	KR 14650		PB 14650

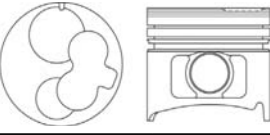

ENGINE TYPE Motortyp/ tipo de motor/ тип двигателя	LINER KIT Liner Kit/ camisas de los cilindros/ Лайнер комплект	CYL. LINER Zylinderlaufbuchse/ camisas de los cilindros/ втулка цилиндра			PISTON + RINGS Kolben + Ringe/ Pistón + Anillos/ поршень и кольца		PISTON SET Kolben Set/ Pistón Set/ поршневой	RINGS SET Ring Set/ Anillos Set/ кольца		PIN Pin/ Perno/ Пин
C223 Early 2,238 cc 4 cyl 88.0 mm Bore Ø			Liner/ Sleeve		Piston			Rings		Ø : 27.0 Length: 68.2
		Length: 163.0 Outside Ø: 90.0 Flange Ø: 95.0 Flange depth: 0.9		Length: 90.0 Comp. height: 47.5 -2.3	Top: 2.5 2nd: 2.0 oil: 4.5					
		Reference no.:			Reference no.:		Reference no.:	Reference no.:		Reference no.:
		5-11261-015-0 5-11261-015-2 8-94169-883-1			5-12111-212-0		5-12121-017-0 5-12121-024-0	5-12251-005-0 5-12251-007-0 9-12251-005-0		
NM-Motorservice Article no./ Artikelnummer/ Modelo número/ статья номер	NM-Motorservice Article no.:	NM-Motorservice Article no.:			NM-Motorservice Article no.:		NM-Motorservice Article no.:	NM-Motorservice Article no.:		NM-Motorservice Article no.:
	LBS 14700 C LBS 14700 CA	LB 14700 C			KBS 14700 KBS 14700 A		KB 14700 KB 14700 A	KR 14700		PB 14700

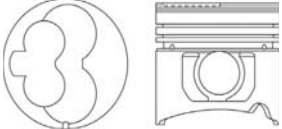

ENGINE TYPE Motortyp/ tipo de motor/ тип двигателя	LINER KIT Liner Kit/ camisas de los cilindros/ Лайнер комплект	CYL. LINER Zylinderlaufbuchse/ camisas de los cilindros/ втулка цилиндра	PISTON + RINGS Kolben + Ringe/ Pistón + Anillos/ поршень и кольца	PISTON SET Kolben Set/ Pistón Set/ поршневой	RINGS SET Ring Set/ Anillos Set/ кольца	PIN Pin/ Perno/ Пин
C223 New 2,238 cc 4 cyl 88.0 mm Bore Ø	C = chromed S = cast iron	chrome	cast iron	Piston	Rings	Ø : 27.0 Length: 68.0
		Length: 163.0 Outside Ø: 90.0 Flange Ø: 95.0 Flange depth: 0.9	164.0 92.2 96.0 5.0			
		Reference no.:		Reference no.:	Reference no.:	Reference no.:
		5-11261-015-0 5-11261-015-2 8-94169-883-1		8-94250-729-0	8-94253-736-0	5-12251-005-0 5-12251-007-0 9-12251-005-0
NM-Motorservice Article no./ Artikelnummer/ Modelo número/ статья номер	NM-Motorservice Article no.:	NM-Motorservice Article no.:	NM-Motorservice Article no.:	NM-Motorservice Article no.:	NM-Motorservice Article no.:	NM-Motorservice Article no.:
	LBS 14750 C LBS 14750 S LBS 14750 CA LBS 14750 SA	LB 14750 C (chromed) LB 14750 S (cast iron)	KBS 14750 KBS 14750 A	KB 14750 KB 14750 A	KR 14750	PB 14750

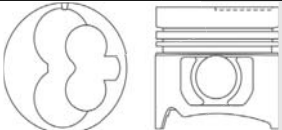

ENGINE TYPE Motortyp/ tipo de motor/ тип двигателя	LINER KIT Liner Kit/ camisas de los cilindros/ Лайнер комплект	CYL. LINER Zylinderlaufbuchse/ camisas de los cilindros/ втулка цилиндра	PISTON + RINGS Kolben + Ringe/ Pistón + Anillos/ поршень и кольца	PISTON SET Kolben Set/ Pistón Set/ поршневой	RINGS SET Ring Set/ Anillos Set/ кольца	PIN Pin/ Perno/ Пин
C223T 2,238 cc 4 cyl 88.0 mm Bore Ø	C = chromed	Liner/ Sleeve	Piston		Rings	Ø : 29.0 Length: 68.0
		Length: 163.0 Outside Ø: 90.0 Flange Ø: 95.0 Flange depth: 0.9				
		Reference no.:		Reference no.:	Reference no.:	Reference no.:
		5-11261-015-0 5-11261-015-2 8-94169-883-1		8-94118-826-0	8-94158-084-0	9-12251-062-0
NM-Motorservice Article no./ Artikelnummer/ Modelo número/ статья номер	NM-Motorservice Article no.:	NM-Motorservice Article no.:	NM-Motorservice Article no.:	NM-Motorservice Article no.:	NM-Motorservice Article no.:	NM-Motorservice Article no.:
	LBS 14800 CA	LBS 14500 C (chromed)	KBS 14500 A	KB 14500 A	KR 14500	PB 14500

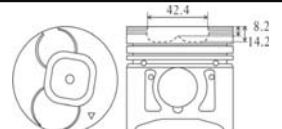

ENGINE TYPE Motortyp/ tipo de motor/ тип двигателя	LINER KIT Liner Kit/ camisas de los cilindros/ Лайнер комплект	CYL. LINER Zylinderlaufbuchse/ camisas de los cilindros/ втулка цилиндра	PISTON + RINGS Kolben + Ringe/ Pistón + Anillos/ поршень и кольца	PISTON SET Kolben Set/ Pistón Set/ поршневой	RINGS SET Ring Set/ Anillos Set/ кольца	PIN Pin/ Perno/ Пин
4FD1 also for OPEL CAMPO 2.2D 2,189 cc 4 cyl 88.0 mm Bore Ø		Flanged	No flange	Piston	Rings	Ø : 27.0 Length: 68.0
		Length: 169.0 Outside Ø: 92.0 Flange Ø: 96.0 Flange depth: 4.0	165.0 92.0			
		Reference no.:		Reference no.:	Reference no.:	Reference no.:
		9-11261-230-0 9-11261-230-1		5-12111-225-0 5-12111-226-0	5-12121-021-0 8-94104-949-0	5-12251-005-0 5-12251-007-0 9-12251-005-0
NM-Motorservice Article no./ Artikelnummer/ Modelo número/ статья номер	NM-Motorservice Article no.:	NM-Motorservice Article no.:	NM-Motorservice Article no.:	NM-Motorservice Article no.:	NM-Motorservice Article no.:	NM-Motorservice Article no.:
	LBS 14850 PA LBS 14850 SA	LB 14850 P LB 14850 S	KBS 14850 A	KB 14850 A	KR 14850	PB 14850

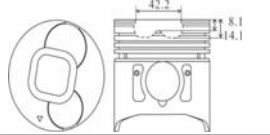

ENGINE TYPE Motortyp/ tipo de motor/ тип двигателя	LINER KIT Liner Kit/ camisas de los cilindros/ Лайнер комплект	CYL. LINER Zylinderlaufbuchse/ camisas de los cilindros/ втулка цилиндра			PISTON + RINGS Kolben + Ringe/ Pistón + Anillos/ поршень и кольца		PISTON SET Kolben Set/ Pistón Set/ поршневой	RINGS SET Ring Set/ Anillos Set/ кольца		PIN Pin/ Perno/ Пин
C223T		Length: 163.0 Outside Ø: 90.0 Flange Ø: 95.0 Flange depth: 0.9	Liner/ Sleeve		Piston		Alfin and with oil gallery	Rings		Ø : 29.0 Length: 68.0
					Length: 82.8 Comp. height: 47.7 -1.75	Top: 2.5 2nd: 2.0 oil: 4.0				
2,238 cc 4 cyl 88.0 mm Bore Ø										
										
NM-Motorservice Article no./ Artikelnummer/ Modelo número/ статья номер	NM-Motorservice Article no.:	NM-Motorservice Article no.:	NM-Motorservice Article no.:	NM-Motorservice Article no.:	NM-Motorservice Article no.:	NM-Motorservice Article no.:	NM-Motorservice Article no.:	NM-Motorservice Article no.:	NM-Motorservice Article no.:	NM-Motorservice Article no.:
	LBS 14900 CB	LB 14900 C		KBS 14900 B		KB 14900 B		KR 14900		PB 14900

ENGINE TYPE Motortyp/ tipo de motor/ тип двигателя	LINER KIT Liner Kit/ camisas de los cilindros/ Лайнер комплект	CYL. LINER Zylinderlaufbuchse/ camisas de los cilindros/ втулка цилиндра			PISTON + RINGS Kolben + Ringe/ Pistón + Anillos/ поршень и кольца		PISTON SET Kolben Set/ Pistón Set/ поршневой	RINGS SET Ring Set/ Anillos Set/ кольца		PIN Pin/ Perno/ Пин
C223T New		Length: 163.0 Outside Ø: 90.0 Flange Ø: 95.0 Flange depth: 0.9	Flanged	No flange	Piston		Alfin and with oil gallery	Rings		Ø : 29.0 Length: 68.0
					Length: 82.6 Comp. height: 47.6 -1.9	Top: 2.5 2nd: 2.0 oil: 4.0				
2,238 cc 4 cyl 88.0 mm Bore Ø										
										
NM-Motorservice Article no./ Artikelnummer/ Modelo número/ статья номер	NM-Motorservice Article no.:	NM-Motorservice Article no.:	NM-Motorservice Article no.:	NM-Motorservice Article no.:	NM-Motorservice Article no.:	NM-Motorservice Article no.:	NM-Motorservice Article no.:	NM-Motorservice Article no.:	NM-Motorservice Article no.:	NM-Motorservice Article no.:
	LBS 14950 CB	LB 14950 C		KBS 14950 B		KB 14950 B		KR 14950		PB 14950

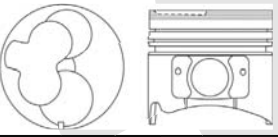
ENGINE TYPE Motortyp/ tipo de motor/ тип двигателя	LINER KIT Liner Kit/ camisas de los cilindros/ Лайнер комплект	CYL. LINER Zylinderlaufbuchse/ camisas de los cilindros/ втулка цилиндра			PISTON + RINGS Kolben + Ringe/ Pistón + Anillos/ поршень и кольца		PISTON SET Kolben Set/ Pistón Set/ поршневой	RINGS SET Ring Set/ Anillos Set/ кольца		PIN Pin/ Perno/ Пин
4JC1		Length: 163.0 Outside Ø: 90.0 Flange Ø: 95.0 Flange depth: 0.9	Flanged	No flange	Piston			Rings		Ø : 31.0 Length: 71.0
					Length: 87.7 Comp. height: 47.8 -14.2	Top: 2.0 2nd: 2.0 oil: 4.0				
2,238 cc 4 cyl 88.0 mm Bore Ø										
										
NM-Motorservice Article no./ Artikelnummer/ Modelo número/ статья номер	NM-Motorservice Article no.:	NM-Motorservice Article no.:	NM-Motorservice Article no.:	NM-Motorservice Article no.:	NM-Motorservice Article no.:	NM-Motorservice Article no.:	NM-Motorservice Article no.:	NM-Motorservice Article no.:	NM-Motorservice Article no.:	NM-Motorservice Article no.:
	LBS 44400 CA	LB 44400 C		KBS 44400 A		KB 44400 A		KR 44400		PB 44400

ENGINE TYPE Motortyp/ tipo de motor/ тип двигателя	LINER KIT Liner Kit/ camisas de los cilindros/ Лайнер комплект	CYL. LINER Zylinderlaufbuchse/ camisas de los cilindros/ втулка цилиндра		PISTON + RINGS Kolben + Ringe/ Pistón + Anillos/ поршень и кольца		PISTON SET Kolben Set/ Pistón Set/ поршневой	RINGS SET Ring Set/ Anillos Set/ кольца		PIN Pin/ Perno/ Пин	
C 2.2 2,189 cc 4 cyl 88.0 mm Bore Ø		Flanged	No flange	Piston			Rings		Ø : Length:	31.0 71.0
		Length: Outside Ø: Flange Ø: Flange depth:	152.0 91.55 92.5 4.0	152.0 91.55	Length: Comp. height:		87.8 47.8 -8.1 -14.0	Top: 2nd: 3rd: oil:		
		Reference no.:				Reference no.:	Reference no.:	Reference no.:		
							8-94417-175-0			
NM-Motorservice Article no./ Artikelnummer/ Modelo número/ статья номер	NM-Motorservice Article no.:	NM-Motorservice Article no.:		NM-Motorservice Article no.:		NM-Motorservice Article no.:	NM-Motorservice Article no.:	NM-Motorservice Article no.:		NM-Motorservice Article no.:
	LBS 15050 P LBS 15050 S LBS 15050 PA LBS 15050 SA	LB 15050 P LB 15050 S		KBS 15050 KBS 15050 A		KB 15050 KB 15050 A	KR 15050			

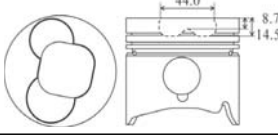





ENGINE TYPE Motortyp/ tipo de motor/ тип двигателя	LINER KIT Liner Kit/ camisas de los cilindros/ Лайнер комплект	CYL. LINER Zylinderlaufbuchse/ camisas de los cilindros/ втулка цилиндра		PISTON + RINGS Kolben + Ringe/ Pistón + Anillos/ поршень и кольца		PISTON SET Kolben Set/ Pistón Set/ поршневой	RINGS SET Ring Set/ Anillos Set/ кольца		PIN Pin/ Perno/ Пин	
4FG1 2,380 cc 4 cyl 89.3 mm Bore Ø		Flanged	No flange	Piston			Rings		Ø : Length:	27.0 68.0
		Length: Outside Ø: Flange Ø: Flange depth:	194.5 93.3 97.3 4.0	190.5 93.3	Length: Comp. height:		80.7 47.2 -2.6	Top: 2nd: oil:		
		Reference no.:				Reference no.:	Reference no.:	Reference no.:		
						8-94454-813-0 8-97073-851-0	8-94469-634-0	8-94247-838-0		
NM-Motorservice Article no./ Artikelnummer/ Modelo número/ статья номер	NM-Motorservice Article no.:	NM-Motorservice Article no.:		NM-Motorservice Article no.:		NM-Motorservice Article no.:	NM-Motorservice Article no.:	NM-Motorservice Article no.:		NM-Motorservice Article no.:
	LBS 15100 PA LBS 15100 SA	LB 15100 P LB 15100 S		KBS 15100 A		KB 15100 A	KR 15100		PB 15100	

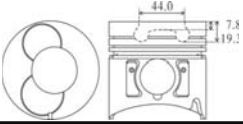

ENGINE TYPE Motortyp/ tipo de motor/ тип двигателя	LINER KIT Liner Kit/ camisas de los cilindros/ Лайнер комплект	CYL. LINER Zylinderlaufbuchse/ camisas de los cilindros/ втулка цилиндра		PISTON + RINGS Kolben + Ringe/ Pistón + Anillos/ поршень и кольца		PISTON SET Kolben Set/ Pistón Set/ поршневой	RINGS SET Ring Set/ Anillos Set/ кольца		PIN Pin/ Perno/ Пин	
4JA1 also for OPEL 4JA1 2,499 cc 4 cyl 93.0 mm Bore Ø	NM-Motorservice Article no.:	chrome	cast iron	Piston			Rings		Ø : Length:	31.0 76.0
		Length: Outside Ø: Flange Ø: Flange depth:	156.0 95.0 101.0 0.9	156.3 98.0 102.0 4.0	Length: Comp. height:		87.9 47.9 -8.7 -14.5	Top: 2nd: oil:		
		Reference no.:				Reference no.:	Reference no.:	Reference no.:		
		8-94110-144-0 8-94462-130-0				8-94152-712-1 8-94369-281-0	8-94247-867-0 8-94247-867-1 8-97319-087-0	8-94247-968-0 8-94419-455-0		
NM-Motorservice Article no./ Artikelnummer/ Modelo número/ статья номер	NM-Motorservice Article no.:	NM-Motorservice Article no.:		NM-Motorservice Article no.:		NM-Motorservice Article no.:	NM-Motorservice Article no.:	NM-Motorservice Article no.:		NM-Motorservice Article no.:
	LBS 15150 C LBS 15150 S LBS 15150 CA LBS 15150 SA	LB 15150 C LB 15150 S LB 15150 - 1 C (chromed OD + 0.25) LB 15150 - 2 C (chromed OD + 0.50) LB 15150 - 3 C (chromed OD + 1.00) LB 15150 - AS (cast iron OD: 96.00)		KBS 15150 KBS 15150 A		KB 15150 KB 15150 A	KR 15150		PB 15150	

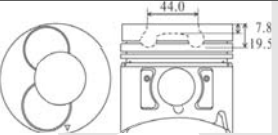

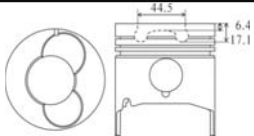
ENGINE TYPE Motortyp/ tipo de motor/ тип двигателя	LINER KIT Liner Kit/ camisas de los cilindros/ Лайнер комплект	CYL. LINER Zylinderlaufbuchse/ camisas de los cilindros/ втулка цилиндра	PISTON + RINGS Kolben + Ringe/ Pistón + Anillos/ поршень и кольца		PISTON SET Kolben Set/ Pistón Set/ поршневой	RINGS SET Ring Set/ Anillos Set/ кольца	PIN Pin/ Perno/ Пин
4JA1 New 2,499 cc 4 cyl 93.0 mm Bore Ø	NM-Motorservice Article no.:		chrome	cast iron	Piston	Rings	Ø : 31.0 Length: 76.0
	LBS 15200-1 CA (chromed OD + 0.25) LBS 15200-2 CA (chromed OD + 0.50) LBS 15200-3 CA (chromed OD + 1.00) LBS 15200-1 SA (cast iron OD: 96.00)	Length: 156.0 Outside Ø: 95.0 Flange Ø: 101.0 Flange depth: 0.9	156.3 98.0 102.0 4.0	Length: 87.8 Comp. height: 47.8 -6.2 -17.4			
	C = chromed S = cast iron	Reference no.:	Reference no.:		Reference no.:	Reference no.:	Reference no.:
		8-94110-144-0 8-94462-130-0	8-94436-892-0 8-97089-892-0 8-97109-181-0 8-97176-601-0		8-94247-867-0 8-94247-867-1 8-97319-087-0	8-94247-968-0 8-94419-455-0	
NM-Motorservice Article no./ Artikelnummer/ Modelo número/ статья номер	NM-Motorservice Article no.:	LB 15200 C LB 15200 S LB 15200 - 1 C (chromed OD + 0.25) LB 15200 - 2 C (chromed OD + 0.50) LB 15200 - 3 C (chromed OD + 1.00) LB 15200 - AS (cast iron OD: 96.00)	NM-Motorservice Article no.:		NM-Motorservice Article no.:	NM-Motorservice Article no.:	NM-Motorservice Article no.:
	LBS 15200 CA LBS 15200 SA		KBS 15200 A		KB 15200 A	KR 15200	PB 15200

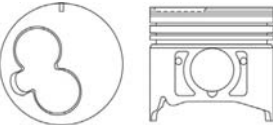

ENGINE TYPE Motortyp/ tipo de motor/ тип двигателя	LINER KIT Liner Kit/ camisas de los cilindros/ Лайнер комплект	CYL. LINER Zylinderlaufbuchse/ camisas de los cilindros/ втулка цилиндра	PISTON + RINGS Kolben + Ringe/ Pistón + Anillos/ поршень и кольца		PISTON SET Kolben Set/ Pistón Set/ поршневой	RINGS SET Ring Set/ Anillos Set/ кольца	PIN Pin/ Perno/ Пин
4JB1 2,771 cc 4 cyl 93.0 mm Bore Ø	LBS 15250-1 CA (chromed OD + 0.25) LBS 15250-2 CA (chromed OD + 0.50) LBS 15250-3 CA (chromed OD + 1.00) LBS 15250-1 SA (cast iron OD: 96.00)	Length: 181.0 Outside Ø: 95.0 Flange Ø: 101.0 Flange depth: 0.9	181.0 98.0 102.0 4.0	Length: 91.8 Comp. height: 51.8 -8.3 15.5		Top: 2.0 2nd: 2.0 oil: 4.0	Ø : 31.0 Length: 76.0
	C = chromed S = cast iron	Reference no.:	Reference no.:		Reference no.:	Reference no.:	Reference no.:
		8-94247-861-0 8-94247-861-2	8-94152-711-0 8-94152-711-1 8-94433-177-0 8-94433-177-1 8-94445-718-0 8-97176-604-0		8-94247-867-0 8-94247-867-1 8-97319-087-0	8-94247-968-0 8-94419-455-0	
NM-Motorservice Article no./ Artikelnummer/ Modelo número/ статья номер	NM-Motorservice Article no.:	LB 15250 C LB 15250 S LB 15250 - 1 C (chromed OD + 0.25) LB 15250 - 2 C (chromed OD + 0.50) LB 15250 - 3 C (chromed OD + 1.00) LB 15250 - 1 S (cast iron OD: 96.00)	NM-Motorservice Article no.:		NM-Motorservice Article no.:	NM-Motorservice Article no.:	NM-Motorservice Article no.:
	LBS 15250 CA LBS 15250 SA		KBS 15250 A		KB 15250 A	KR 15250	PB 15250

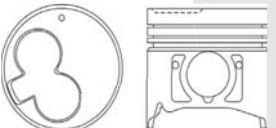

ENGINE TYPE Motortyp/ tipo de motor/ тип двигателя	LINER KIT Liner Kit/ camisas de los cilindros/ Лайнер комплект	CYL. LINER Zylinderlaufbuchse/ camisas de los cilindros/ втулка цилиндра	PISTON + RINGS Kolben + Ringe/ Pistón + Anillos/ поршень и кольца		PISTON SET Kolben Set/ Pistón Set/ поршневой	RINGS SET Ring Set/ Anillos Set/ кольца	PIN Pin/ Perno/ Пин
4JB1T 2,771 cc 4 cyl 93.0 mm Bore Ø	LBS 15300-1 CA (chromed OD + 0.25) LBS 15300-2 CA (chromed OD + 0.50) LBS 15300-3 CA (chromed OD + 1.00) LBS 15300-1 SA (cast iron OD: 96.00)	Length: 181.0 Outside Ø: 95.0 Flange Ø: 101.0 Flange depth: 0.9	181.0 98.0 102.0 4.0	Length: 92.0 Comp. height: 52.0 -7.6 -13.75		Top: 2.0 2nd: 2.0 oil: 4.0	Ø : 34.0 Length: 78.0
		Reference no.:	Reference no.:		Reference no.:	Reference no.:	Reference no.:
		8-94247-861-0 8-94247-861-2	8-94340-620-2 8-94369-218-0 8-97176-602-0		8-94247-867-0 8-94247-867-1 8-97319-087-0	8-94457-158-0	
NM-Motorservice Article no./ Artikelnummer/ Modelo número/ статья номер	NM-Motorservice Article no.:	LB 15300 C LB 15300 S LB 15300 - 1 C (chromed OD + 0.25) LB 15300 - 2 C (chromed OD + 0.50) LB 15300 - 3 C (chromed OD + 1.00) LB 15300 - 1 S (cast iron OD: 96.00)	NM-Motorservice Article no.:		NM-Motorservice Article no.:	NM-Motorservice Article no.:	NM-Motorservice Article no.:
	LBS 15300 CA LBS 15300 SA		KBS 15300 A		KB 15300 A	KR 15300	PB 15300



ENGINE TYPE Motortyp/ tipo de motor/ тип двигателя	LINER KIT Liner Kit/ camisas de los cilindros/ Лайнер комплект	CYL. LINER Zylinderlaufbuchse/ camisas de los cilindros/ втулка цилиндра	PISTON + RINGS Kolben + Ringe/ Pistón + Anillos/ поршень и кольца	PISTON SET Kolben Set/ Pistón Set/ поршневой	RINGS SET Ring Set/ Anillos Set/ кольца	PIN Pin/ Perno/ Пин															
4JB1T New 2,771 cc 4 cyl 93.0 mm Bore Ø	LBS 15350-1 CA (chromed OD + 0.25) LBS 15350-2 CA (chromed OD + 0.50) LBS 15350-3 CA (chromed OD + 1.00) LBS 15350-1 SA (cast iron OD: 96.00)	<table border="1"> <tr> <td></td> <td>chrome</td> <td>No flange</td> </tr> <tr> <td>Length:</td> <td>181.0</td> <td>181.0</td> </tr> <tr> <td>Outside Ø:</td> <td>95.0</td> <td>98.0</td> </tr> <tr> <td>Flange Ø:</td> <td>101.0</td> <td>102.0</td> </tr> <tr> <td>Flange depth:</td> <td>0.9</td> <td>4.0</td> </tr> </table>		chrome	No flange	Length:	181.0	181.0	Outside Ø:	95.0	98.0	Flange Ø:	101.0	102.0	Flange depth:	0.9	4.0	Piston Length: 92.0 Comp. height: 52.0 -7.8 -19.3		Rings Top: 2.0 2nd: 2.0 oil: 4.0 Ø: 34.0 Length: 78.0	
			chrome	No flange																	
		Length:	181.0	181.0																	
		Outside Ø:	95.0	98.0																	
Flange Ø:	101.0	102.0																			
Flange depth:	0.9	4.0																			
Reference no.:	8-94247-861-0 8-94247-861-2	Reference no.:	Reference no.:	Reference no.:																	
NM-Motorservice Article no.:		8-94460-887-1 8-97108-621-0	8-94247-867-0 8-94247-867-1 8-97319-087-0	8-94457-158-0																	
NM-Motorservice Article no.:																					
																					
NM-Motorservice Article no./ Artikelnummer/ Modelo número/ статья номер	NM-Motorservice Article no.:	LB 15350 C LB 15350 S LB 15350-1 C (chromed OD + 0.25) LB 15350-2 C (chromed OD + 0.50) LB 15350-3 C (chromed OD + 1.00) LB 15350-1 S (cast iron OD: 96.00)	NM-Motorservice Article no.:	NM-Motorservice Article no.:	NM-Motorservice Article no.:	NM-Motorservice Article no.:															
	LBS 15350 CA LBS 15350 SA		KBS 15350 A	KB 15350 A	KR 15350	PB 15350															
4JB1 New 2,771 cc 4 cyl 93.0 mm Bore Ø	LBS 15400-1 CA (chromed OD + 0.25) LBS 15400-2 CA (chromed OD + 0.50) LBS 15400-3 CA (chromed OD + 1.00) LBS 15400-1 SA (cast iron OD: 96.00)	<table border="1"> <tr> <td></td> <td>chrome</td> <td>cast iron</td> </tr> <tr> <td>Length:</td> <td>181.0</td> <td>181.0</td> </tr> <tr> <td>Outside Ø:</td> <td>95.0</td> <td>98.0</td> </tr> <tr> <td>Flange Ø:</td> <td>101.0</td> <td>102.0</td> </tr> <tr> <td>Flange depth:</td> <td>0.9</td> <td>4.0</td> </tr> </table>		chrome	cast iron	Length:	181.0	181.0	Outside Ø:	95.0	98.0	Flange Ø:	101.0	102.0	Flange depth:	0.9	4.0	Piston Length: 91.8 Comp. height: 51.8 -7.8 -19.5		Rings Top: 2.0 2nd: 2.0 oil: 4.0 Ø: 31.0 Length: 76.0	
			chrome	cast iron																	
		Length:	181.0	181.0																	
		Outside Ø:	95.0	98.0																	
Flange Ø:	101.0	102.0																			
Flange depth:	0.9	4.0																			
Reference no.:	8-94247-861-0 8-94247-861-2	Reference no.:	Reference no.:	Reference no.:																	
NM-Motorservice Article no.:		8-97176-606-0	8-94247-867-0 8-94247-867-1 8-97319-087-0	8-94247-968-0 8-94419-455-0																	
NM-Motorservice Article no.:																					
																					
NM-Motorservice Article no./ Artikelnummer/ Modelo número/ статья номер	NM-Motorservice Article no.:	LB 15400 C LB 15400 S LB 15400-1 C (chromed OD + 0.25) LB 15400-2 C (chromed OD + 0.50) LB 15400-3 C (chromed OD + 1.00) LB 15400-1 S (cast iron OD: 96.00)	NM-Motorservice Article no.:	NM-Motorservice Article no.:	NM-Motorservice Article no.:	NM-Motorservice Article no.:															
	LBS 15400 CA LBS 15400 SA		KBS 15400 A	KB 15400 A	KR 15400	PB 15400															
4JA1T New 2,499 cc 4 cyl 93.0 mm Bore Ø	LBS 15450-1 CA (chromed OD + 0.25) LBS 15450-2 CA (chromed OD + 0.50) LBS 15450-3 CA (chromed OD + 1.00) LBS 15450-1 SA (cast iron OD: 96.00)	<table border="1"> <tr> <td></td> <td>chrome</td> <td>cast iron</td> </tr> <tr> <td>Length:</td> <td>156.0</td> <td>156.3</td> </tr> <tr> <td>Outside Ø:</td> <td>95.0</td> <td>98.0</td> </tr> <tr> <td>Flange Ø:</td> <td>101.0</td> <td>102.0</td> </tr> <tr> <td>Flange depth:</td> <td>0.9</td> <td>4.0</td> </tr> </table>		chrome	cast iron	Length:	156.0	156.3	Outside Ø:	95.0	98.0	Flange Ø:	101.0	102.0	Flange depth:	0.9	4.0	Piston Length: 102.8 Comp. height: 47.8 -6.4 -17.1		Rings Top: 2.0 2nd: 2.0 oil: 4.0 Ø: 31.0 Length: 76.0	
			chrome	cast iron																	
		Length:	156.0	156.3																	
		Outside Ø:	95.0	98.0																	
Flange Ø:	101.0	102.0																			
Flange depth:	0.9	4.0																			
Reference no.:	8-94110-144-0 8-94462-130-0	Reference no.:	Reference no.:	Reference no.:																	
Reference no.:	5-87814-401-0	8-97176-691-0 8-97176-695-0	8-94247-867-0 8-94247-867-1 8-97319-087-0	8-94247-968-0 8-94419-455-0																	
NM-Motorservice Article no.:																					
																					
NM-Motorservice Article no./ Artikelnummer/ Modelo número/ статья номер	NM-Motorservice Article no.:	LB 15450 C LB 15450 S LB 15450-1 C (chromed OD + 0.25) LB 15450-2 C (chromed OD + 0.50) LB 15450-3 C (chromed OD + 1.00) LB 15450-1 S (cast iron OD: 96.00)	NM-Motorservice Article no.:	NM-Motorservice Article no.:	NM-Motorservice Article no.:	NM-Motorservice Article no.:															
	LBS 15450 CA LBS 15450 SA		KBS 15450 A	KB 15450 A	KR 15450	PB 15450															

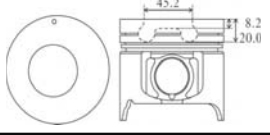

ENGINE TYPE Motortyp/ tipo de motor/ тип двигателя	LINER KIT Liner Kit/ camisas de los cilindros/ Лайнер комплект	CYL. LINER Zylinderlaufbuchse/ camisas de los cilindros/ втулка цилиндра			PISTON + RINGS Kolben + Ringe/ Pistón + Anillos/ поршень и кольца		PISTON SET Kolben Set/ Pistón Set/ поршневой	RINGS SET Ring Set/ Anillos Set/ кольца		PIN Pin/ Perno/ Пин	
4JG2 3,059 cc 4 cyl 95.4 mm Bore Ø	NM-Motorservice Article no.:		chrome	cast iron	Piston			Rings			
	LBS 44200 -1 CA (chromed OD + 0.25) LBS 44200 -2 CA (chromed OD + 0.50) LBS 44200 -3 CA (chromed OD + 1.00) LBS 44200 -1 SA (cast iron OD: 98.00)	Length: Outside Ø: Flange Ø: Flange depth:	178.6 97.0 102.3 1.1	181.5 100.0 103.3 4.0	Length: Comp. height:	89.2 49.2 -2.6		Top: 2nd: oil:	2.5 2.0 4.0	Ø: Length:	34.0 78.0
		Reference no.:					Reference no.:	Reference no.:	Reference no.:		
		8-97176-702-0 8-94456-791-0					8-97073-647-1	8-97080-215-0	8-94457-158-0		
NM-Motorservice Article no./ Artikelnummer/ Modelo número/ статья номер	NM-Motorservice Article no.:	LB 44200 C LB 44200 S LB 44200 - 1 C (chromed OD + 0.25) LB 44200 - 2 C (chromed OD + 0.50) LB 44200 - 3 C (chromed OD + 1.00) LB 44200 - 1 S (cast iron OD: 98.00)			NM-Motorservice Article no.:		NM-Motorservice Article no.:	NM-Motorservice Article no.:	NM-Motorservice Article no.:		
	LBS 44200 CA LBS 44200 SA				KBS 44200 A		KB 44200 A	KR 44200	PB 44200		

ENGINE TYPE Motortyp/ tipo de motor/ тип двигателя	LINER KIT Liner Kit/ camisas de los cilindros/ Лайнер комплект	CYL. LINER Zylinderlaufbuchse/ camisas de los cilindros/ втулка цилиндра			PISTON + RINGS Kolben + Ringe/ Pistón + Anillos/ поршень и кольца		PISTON SET Kolben Set/ Pistón Set/ поршневой	RINGS SET Ring Set/ Anillos Set/ кольца		PIN Pin/ Perno/ Пин	
4JG2T 3,059 cc 4 cyl 95.4 mm Bore Ø	LBS 15550 -1 CB (chromed OD + 0.25) LBS 15550 -2 CB (chromed OD + 0.50) LBS 15550 -3 CB (chromed OD + 1.00) LBS 15550 -1 SB (cast iron OD: 98.00)		chrome	cast iron	Piston		Alfin and with oil gallery head anodized	Rings			
		Length: Outside Ø: Flange Ø: Flange depth:	178.6 97.0 102.3 1.1	181.5 100.0 103.3 4.0	Length: Comp. height:	89.1 49.1 -2.7		Top: 2nd: oil:	2.5 2.0 4.0	Ø: Length:	34.0 78.0
		Reference no.:					Reference no.:	Reference no.:	Reference no.:		
		8-97176-702-0 8-94456-791-0					8-97086-449-0 8-97176-622-0 8-97176-623-0	8-97080-215-0	8-94457-158-0		
NM-Motorservice Article no./ Artikelnummer/ Modelo número/ статья номер	NM-Motorservice Article no.:	LB 15550 C LB 15550 S LB 15550 - 1 C (chromed OD + 0.25) LB 15550 - 2 C (chromed OD + 0.50) LB 15550 - 3 C (chromed OD + 1.00) LB 15550 - 1 S (cast iron OD: 98.00)			NM-Motorservice Article no.:		NM-Motorservice Article no.:	NM-Motorservice Article no.:	NM-Motorservice Article no.:		
	LBS 15550 CB LBS 15550 SB				KBS 15550 B		KB 15550 B	KR 15550	PB 15550		

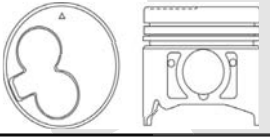
ENGINE TYPE Motortyp/ tipo de motor/ тип двигателя	LINER KIT Liner Kit/ camisas de los cilindros/ Лайнер комплект	CYL. LINER Zylinderlaufbuchse/ camisas de los cilindros/ втулка цилиндра			PISTON + RINGS Kolben + Ringe/ Pistón + Anillos/ поршень и кольца		PISTON SET Kolben Set/ Pistón Set/ поршневой	RINGS SET Ring Set/ Anillos Set/ кольца		PIN Pin/ Perno/ Пин	
4JX1 also for OPEL 4JX1T 2,999 cc 4 cyl 95.4 mm Bore Ø			Flanged	No flange	Piston		Alfin and with oil gallery head anodized skirt MOS2 treated	Rings			
		Length: Outside Ø: Flange Ø: Flange depth:	180.0 99.4 103.4 4.0	177.0 99.4	Length: Comp. height:	101.7 50.0 -9.6 -17.4		Top: 2nd: oil:	2.5 2.0 4.0	Ø: Length:	31.0 75.9
		Reference no.:					Reference no.:	Reference no.:	Reference no.:		
		8-94247-861-0 8-94247-861-2					8-94340-620-2 8-94369-218-0 8-97176-602-0	8-94247-867-0 8-94247-867-1 8-97319-087-0	8-94457-158-0		
NM-Motorservice Article no./ Artikelnummer/ Modelo número/ статья номер	NM-Motorservice Article no.:	NM-Motorservice Article no.:			NM-Motorservice Article no.:		NM-Motorservice Article no.:	NM-Motorservice Article no.:	NM-Motorservice Article no.:		
	LBS 15600 PB LBS 15600 SB	LB 15600 P LB 15600 S			KBS 15600 B		KB 15600 B	KR 15600	PB 15600		

ENGINE TYPE Motortyp/ tipo de motor/ тип двигателя	LINER KIT Liner Kit/ camisas de los cilindros/ Лайнер комплект	CYL. LINER Zylinderlaufbuchse/ camisas de los cilindros/ втулка цилиндра	PISTON + RINGS Kolben + Ringe/ Pistón + Anillos/ поршень и кольца		PISTON SET Kolben Set/ Pistón Set/ поршневой	RINGS SET Ring Set/ Anillos Set/ кольца	PIN Pin/ Perno/ Пин															
4JH1-TC 2,999 cc 4 cyl 95.4 mm Bore Ø	LBS 15650-1 CB (chromed OD + 0.25) LBS 15650-2 CB (chromed OD + 0.50) LBS 15650-3 CB (chromed OD + 1.00) LBS 15650-1 SB (cast iron OD: 98.00)	<table border="1"> <tr> <td></td> <td>chrome</td> <td>No flange</td> </tr> <tr> <td>Length:</td> <td>178.6</td> <td>181.5</td> </tr> <tr> <td>Outside Ø:</td> <td>97.0</td> <td>100.0</td> </tr> <tr> <td>Flange Ø:</td> <td>102.3</td> <td>103.3</td> </tr> <tr> <td>Flange depth:</td> <td>1.1</td> <td>4.0</td> </tr> </table>		chrome	No flange	Length:	178.6	181.5	Outside Ø:	97.0	100.0	Flange Ø:	102.3	103.3	Flange depth:	1.1	4.0	Piston Length: 88.9 Comp. height: 49.9 -8.2 -20.0		Alfin and with oil gallery	Rings Top: 2.5 2nd: 2.0 oil: 3.0	Ø: 31.0 Length: 76.0
				chrome	No flange																	
Length:	178.6	181.5																				
Outside Ø:	97.0	100.0																				
Flange Ø:	102.3	103.3																				
Flange depth:	1.1	4.0																				
Reference no.:		Reference no.:		Reference no.:																		
		8-97176-702-0 8-94456-791-0		Reference no.:		Reference no.:																
NM-Motorservice Article no.:/ Artikelnummer/ Modelo número/ статья номер		NM-Motorservice Article no.:		NM-Motorservice Article no.:		NM-Motorservice Article no.:																
		LBS 15650 CB LBS 15650 SB		KBS 15650 B		KB 15650 B																
		LB 15650 C LB 15650 S LB 15650-1 C (chromed OD + 0.25) LB 15650-2 C (chromed OD + 0.50) LB 15650-3 C (chromed OD + 1.00) LB 15650-1 S (cast iron OD: 98.00)		KB 15650 B		KR 15650																

ENGINE TYPE Motortyp/ tipo de motor/ тип двигателя	LINER KIT Liner Kit/ camisas de los cilindros/ Лайнер комплект	CYL. LINER Zylinderlaufbuchse/ camisas de los cilindros/ втулка цилиндра	PISTON + RINGS Kolben + Ringe/ Pistón + Anillos/ поршень и кольца		PISTON SET Kolben Set/ Pistón Set/ поршневой	RINGS SET Ring Set/ Anillos Set/ кольца	PIN Pin/ Perno/ Пин															
4JG2T New 3,059 cc 4 cyl 95.4 mm Bore Ø	LBS 15700-1 CB (chromed OD + 0.25) LBS 15700-2 CB (chromed OD + 0.50) LBS 15700-3 CB (chromed OD + 1.00) LBS 15700-1 SB (cast iron OD: 98.00)	<table border="1"> <tr> <td></td> <td>chrome</td> <td>cast iron</td> </tr> <tr> <td>Length:</td> <td>178.6</td> <td>181.5</td> </tr> <tr> <td>Outside Ø:</td> <td>97.0</td> <td>100.0</td> </tr> <tr> <td>Flange Ø:</td> <td>102.3</td> <td>103.3</td> </tr> <tr> <td>Flange depth:</td> <td>1.1</td> <td>4.0</td> </tr> </table>		chrome	cast iron	Length:	178.6	181.5	Outside Ø:	97.0	100.0	Flange Ø:	102.3	103.3	Flange depth:	1.1	4.0	Piston Length: 89.2 Comp. height: 49.2 -1.4		Alfin and with oil gallery head anodized	Rings Top: 2.5 2nd: 2.0 oil: 4.0	Ø: 34.0 Length: 78.0
				chrome	cast iron																	
Length:	178.6	181.5																				
Outside Ø:	97.0	100.0																				
Flange Ø:	102.3	103.3																				
Flange depth:	1.1	4.0																				
Reference no.:		Reference no.:		Reference no.:																		
		8-97176-702-0 8-94456-791-0		Reference no.:		Reference no.:																
NM-Motorservice Article no.:/ Artikelnummer/ Modelo número/ статья номер		NM-Motorservice Article no.:		NM-Motorservice Article no.:		NM-Motorservice Article no.:																
		LBS 15700 CB LBS 15700 SB		KBS 15700 B		KB 15700 B																
		LB 15700 C LB 15700 S LB 15700-1 C (chromed OD + 0.25) LB 15700-2 C (chromed OD + 0.50) LB 15700-3 C (chromed OD + 1.00) LB 15700-1 S (cast iron OD: 98.00)		KB 15700 B		KR 15700																

ENGINE TYPE Motortyp/ tipo de motor/ тип двигателя	LINER KIT Liner Kit/ camisas de los cilindros/ Лайнер комплект	CYL. LINER Zylinderlaufbuchse/ camisas de los cilindros/ втулка цилиндра	PISTON + RINGS Kolben + Ringe/ Pistón + Anillos/ поршень и кольца		PISTON SET Kolben Set/ Pistón Set/ поршневой	RINGS SET Ring Set/ Anillos Set/ кольца	PIN Pin/ Perno/ Пин															
4JH1-TC New 2,999 cc 4 cyl 95.4 mm Bore Ø	LBS 15750-1 CB (chromed OD + 0.25) LBS 15750-2 CB (chromed OD + 0.50) LBS 15750-3 CB (chromed OD + 1.00) LBS 15750-1 SB (cast iron OD: 98.00)	<table border="1"> <tr> <td></td> <td>chrome</td> <td>cast iron</td> </tr> <tr> <td>Length:</td> <td>178.6</td> <td>181.5</td> </tr> <tr> <td>Outside Ø:</td> <td>97.0</td> <td>100.0</td> </tr> <tr> <td>Flange Ø:</td> <td>102.3</td> <td>103.3</td> </tr> <tr> <td>Flange depth:</td> <td>1.1</td> <td>4.0</td> </tr> </table>		chrome	cast iron	Length:	178.6	181.5	Outside Ø:	97.0	100.0	Flange Ø:	102.3	103.3	Flange depth:	1.1	4.0	Piston Length: 89.0 Comp. height: 50.0 -8.0 -19.9		Alfin and with oil gallery	Rings Top: 2.5 2nd: 2.0 oil: 3.0	Ø: 31.0 Length: 76.0
				chrome	cast iron																	
Length:	178.6	181.5																				
Outside Ø:	97.0	100.0																				
Flange Ø:	102.3	103.3																				
Flange depth:	1.1	4.0																				
Reference no.:		Reference no.:		Reference no.:																		
		8-97176-702-0		Reference no.:		Reference no.:																
NM-Motorservice Article no.:/ Artikelnummer/ Modelo número/ статья номер		NM-Motorservice Article no.:		NM-Motorservice Article no.:		NM-Motorservice Article no.:																
		LBS 15750 CB LBS 15750 SB		KBS 15750 B		KB 15750 B																
		LB 15750 C LB 15750 S LB 15750-1 C (chromed OD + 0.25) LB 15750-2 C (chromed OD + 0.50) LB 15750-3 C (chromed OD + 1.00) LB 15750-1 S (cast iron OD: 98.00)		KB 15750 B		KR 15750																

ENGINE TYPE Motortyp/ tipo de motor/ тип двигателя	LINER KIT Liner Kit/ camisas de los cilindros/ Лайнер комплект	CYL. LINER Zylinderlaufbuchse/ camisas de los cilindros/ втулка цилиндра			PISTON + RINGS Kolben + Ringe/ Pistón + Anillos/ поршень и кольца	PISTON SET Kolben Set/ Pistón Set/ поршневой	RINGS SET Ring Set/ Anillos Set/ кольца	PIN Pin/ Perno/ Пин	
4JJ1-TC CRDi UCR-UCS-LHD 2,999 cc 4 cyl 95.4 mm Bore Ø			Flanged	No flange	Piston		Rings		
		Length: Outside Ø: Flange Ø: Flange depth:	180.0 99.4 103.4 4.0	177.0 99.4	Length: Comp. height:	78.4 49.8 -5.3 -16.1	Alfin and with oil gallery skirt MOS2 treated	Top: 2nd: oil:	2.0 1.5 3.0
		Reference no.:				Reference no.:	Reference no.:	Reference no.:	
						8-97367-397-1 8-97367-398-1 8-97367-399-1 8-97388-327-0	8-97388-734-0 8-97389-284-0 8-98096-676-0	8-97388-734-0 8-97389-284-0 8-98096-676-0	
NM-Motorservice Article no./ Artikelnummer/ Modelo número/ статья номер	NM-Motorservice Article no.:	NM-Motorservice Article no.:	NM-Motorservice Article no.:	NM-Motorservice Article no.:	NM-Motorservice Article no.:	NM-Motorservice Article no.:	NM-Motorservice Article no.:	NM-Motorservice Article no.:	
	LBS 15800 PB LBS 15800 SB	LB 15800 P LB 15800 S		KBS 15800 B	KB 15800 B	KR 15800	PB 15800		



ENGINE TYPE Motortyp/ tipo de motor/ тип двигателя	LINER KIT Liner Kit/ camisas de los cilindros/ Лайнер комплект	CYL. LINER Zylinderlaufbuchse/ camisas de los cilindros/ втулка цилиндра			PISTON + RINGS Kolben + Ringe/ Pistón + Anillos/ поршень и кольца	PISTON SET Kolben Set/ Pistón Set/ поршневой	RINGS SET Ring Set/ Anillos Set/ кольца	PIN Pin/ Perno/ Пин	
4JK1-TC KB250 2,499 cc 4 cyl 95.4 mm Bore Ø			Flanged	No flange	Piston		Rings		
		Length: Outside Ø: Flange Ø: Flange depth:	180.0 99.4 103.4 4.0	177.0 99.4	Length: Comp. height:	87.2 58.55 -6.3 -16.7	Alfin and with oil gallery skirt MOS2 treated	Top: 2nd: oil:	2.0 1.5 3.0
		Reference no.:				Reference no.:	Reference no.:	Reference no.:	
						8-97355-672-2	8-97388-734-0 8-97389-284-0 8-98096-676-0		
NM-Motorservice Article no./ Artikelnummer/ Modelo número/ статья номер	NM-Motorservice Article no.:	NM-Motorservice Article no.:	NM-Motorservice Article no.:	NM-Motorservice Article no.:	NM-Motorservice Article no.:	NM-Motorservice Article no.:	NM-Motorservice Article no.:	NM-Motorservice Article no.:	
	LBS 15850 PB LBS 15850 SB	LB 15850 P LB 15850 S		KBS 15850 B	KB 15850 B	KR 15850			



ENGINE TYPE Motortyp/ tipo de motor/ тип двигателя	LINER KIT Liner Kit/ camisas de los cilindros/ Лайнер комплект	CYL. LINER Zylinderlaufbuchse/ camisas de los cilindros/ втулка цилиндра			PISTON + RINGS Kolben + Ringe/ Pistón + Anillos/ поршень и кольца	PISTON SET Kolben Set/ Pistón Set/ поршневой	RINGS SET Ring Set/ Anillos Set/ кольца	PIN Pin/ Perno/ Пин	
4JG2T 3,059 cc 4 cyl 95.4 mm Bore Ø			chrome	cast iron	Piston		Rings		
		Length: Outside Ø: Flange Ø: Flange depth:	178.6 97.0 102.3 1.1	181.5 100.0 103.3 4.0	Length: Comp. height:	89.2 49.2 -2.4	Alfin and with oil gallery head anodized top ring double keystoned	Top: 2nd: oil:	2.5 2.0 4.0
		Reference no.:				Reference no.:	Reference no.:	Reference no.:	
						8-97176-702-0 8-94456-791-0	8-94370-449-0	8-94457-158-0	
NM-Motorservice Article no./ Artikelnummer/ Modelo número/ статья номер	NM-Motorservice Article no.:	NM-Motorservice Article no.:	NM-Motorservice Article no.:	NM-Motorservice Article no.:	NM-Motorservice Article no.:	NM-Motorservice Article no.:	NM-Motorservice Article no.:	NM-Motorservice Article no.:	
	LBS 15900 CB LBS 15900 SB	LB 15900 C LB 15900 S		KBS 15900 B	KB 15900 B	KR 15900	PB 15900		



ENGINE TYPE Motortyp/ tipo de motor/ тип двигателя	LINER KIT Liner Kit/ camisas de los cilindros/ Лайнер комплект	CYL. LINER Zylinderlaufbuchse/ camisas de los cilindros/ втулка цилиндра		PISTON + RINGS Kolben + Ringe/ Pistón + Anillos/ поршень и кольца		PISTON SET Kolben Set/ Pistón Set/ поршневой	RINGS SET Ring Set/ Anillos Set/ кольца		PIN Pin/ Perno/ Пин	
4JG1		chrome	cast iron	Piston			Rings		Ø: Length:	34.0 78.0
				Length: Outside Ø: Flange Ø: Flange depth:	178.6 97.0 102.3 1.1		181.5 100.0 103.3 4.0	Length: Comp. height:		
3,059 cc 4 cyl 95.4 mm Bore Ø										
NM-Motorservice Article no./ Artikelnummer/ Modelo número/ статья номер	NM-Motorservice Article no.:	NM-Motorservice Article no.:		NM-Motorservice Article no.:		NM-Motorservice Article no.:	NM-Motorservice Article no.:	NM-Motorservice Article no.:	NM-Motorservice Article no.:	
	LBS 15950 CA LBS 15950 SA	LB 15950 C LB 15950 S		KBS 15950 A		KB 15950 A	KR 15950	PB 15950		

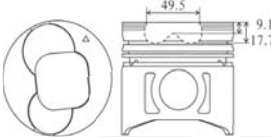

ENGINE TYPE Motortyp/ tipo de motor/ тип двигателя	LINER KIT Liner Kit/ camisas de los cilindros/ Лайнер комплект	CYL. LINER Zylinderlaufbuchse/ camisas de los cilindros/ втулка цилиндра		PISTON + RINGS Kolben + Ringe/ Pistón + Anillos/ поршень и кольца		PISTON SET Kolben Set/ Pistón Set/ поршневой	RINGS SET Ring Set/ Anillos Set/ кольца		PIN Pin/ Perno/ Пин	
4BA1		chrome	cast iron	Piston			Rings		Ø: Length:	33.0 85.0
				Length: Outside Ø: Flange Ø: Flange depth:	180.5 101.0 108.0 1.4		180.0 102.2 108.0	Length: Comp. height:		
2,775 cc 4 cyl 98.0 mm Bore Ø										
NM-Motorservice Article no./ Artikelnummer/ Modelo número/ статья номер	NM-Motorservice Article no.:	NM-Motorservice Article no.:		NM-Motorservice Article no.:		NM-Motorservice Article no.:	NM-Motorservice Article no.:	NM-Motorservice Article no.:	NM-Motorservice Article no.:	
	LBS 31300 C LBS 31300 S	LB 31300 C LB 31300 S		KBS 31300		KB 31300	KR 31300	PB 31300		

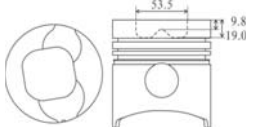

ENGINE TYPE Motortyp/ tipo de motor/ тип двигателя	LINER KIT Liner Kit/ camisas de los cilindros/ Лайнер комплект	CYL. LINER Zylinderlaufbuchse/ camisas de los cilindros/ втулка цилиндра		PISTON + RINGS Kolben + Ringe/ Pistón + Anillos/ поршень и кольца		PISTON SET Kolben Set/ Pistón Set/ поршневой	RINGS SET Ring Set/ Anillos Set/ кольца		PIN Pin/ Perno/ Пин	
DA220 4 Rings		Flanged	No flange	Piston			Rings		Ø: Length:	34.0 83.5
				Length: Outside Ø: Flange Ø: Flange depth:	220.0 113.0 119.0 8.0			Length: Comp. height:		
4,084 cc 4 cyl 100.0 mm Bore Ø										
NM-Motorservice Article no./ Artikelnummer/ Modelo número/ статья номер	NM-Motorservice Article no.:	NM-Motorservice Article no.:		NM-Motorservice Article no.:		NM-Motorservice Article no.:	NM-Motorservice Article no.:	NM-Motorservice Article no.:	NM-Motorservice Article no.:	
	LBS 16050 F	LB 16050 F		KBS 16050		KB 16050	KR 16050	PB 16050		

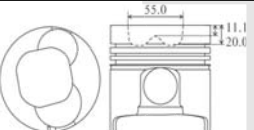

ENGINE TYPE Motortyp/ tipo de motor/ тип двигателя	LINER KIT Liner Kit/ camisas de los cilindros/ Лайнер комплект	CYL. LINER Zylinderlaufbuchse/ camisas de los cilindros/ втулка цилиндра			PISTON + RINGS Kolben + Ringe/ Pistón + Anillos/ поршень и кольца		PISTON SET Kolben Set/ Pistón Set/ поршневой	RINGS SET Ring Set/ Anillos Set/ кольца			PIN Pin/ Perno/ Пин	
4BC1			Flanged	No flange	Piston			Rings			Ø : 33.0 Length: 83.0	
		Length: 187.0 Outside Ø: 105.0 Flange Ø: 112.0 Flange depth: 1.4			Length: 112.0 Comp. height: 58.5 -0.4 -2.2			Top: 3.0 2nd: 2.5 oil: 5.0				
3,268 cc 4 cyl 102.0 mm Bore Ø		Reference no.:				Reference no.:	Reference no.:	Reference no.:		Reference no.:		
		5-11261-014-0 5-11261-014-2				5-12111-172-1 5-12111-188-1	5-12121-004-0 5-12121-005-0 5-12181-003-1 5-12181-024-1 5-45454-004-2	5-12251-010-0 9-12251-603-0				
NM-Motorservice Article no./ Artikelnummer/ Modelo нúmero/ статья номер	NM-Motorservice Article no.:	NM-Motorservice Article no.:			NM-Motorservice Article no.:	NM-Motorservice Article no.:	NM-Motorservice Article no.:	NM-Motorservice Article no.:		NM-Motorservice Article no.:		
	LBS 16150 CA	LB 16150 C			KBS 16150 A	KB 16150 A	KR 16150	PB 16150				

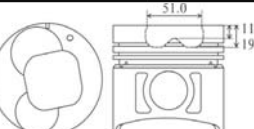

ENGINE TYPE Motortyp/ tipo de motor/ тип двигателя	LINER KIT Liner Kit/ camisas de los cilindros/ Лайнер комплект	CYL. LINER Zylinderlaufbuchse/ camisas de los cilindros/ втулка цилиндра			PISTON + RINGS Kolben + Ringe/ Pistón + Anillos/ поршень и кольца		PISTON SET Kolben Set/ Pistón Set/ поршневой	RINGS SET Ring Set/ Anillos Set/ кольца			PIN Pin/ Perno/ Пин	
4BC2			chrome	cast iron	Piston			Rings			Ø : 35.0 Length: 87.5	
		Length: 187.0 Outside Ø: 105.0 Flange Ø: 112.0 Flange depth: 1.4	187.0 106.0 112.0 4.0		Length: 98.1 Comp. height: 58.9 -9.1 -17.7			Top: 3.0 2nd: 2.5 oil: 5.0				
3,268 cc 4 cyl 102.0 mm Bore Ø		LB 16200 - 2 F/ LB 16200 - 2 S:				Reference no.:	Reference no.:	Reference no.:		Reference no.:		
		Length: 185.5 Outside Ø: 106.0 Flange Ø: 110.3 Flange depth: 10.1				8-94169-765-0	5-12121-004-0 5-12121-005-0 5-12181-003-1 5-12181-024-1 5-45454-004-2	1-12251-027-0 5-12251-006-0 9-12251-602-0				
NM-Motorservice Article no./ Artikelnummer/ Modelo нúmero/ статья номер	NM-Motorservice Article no.:	NM-Motorservice Article no.:			NM-Motorservice Article no.:	NM-Motorservice Article no.:	NM-Motorservice Article no.:	NM-Motorservice Article no.:		NM-Motorservice Article no.:		
	LBS 16200 C LBS 16200 F LBS 16200 S LBS 16200 CA LBS 16200 FA LBS 16200 SA Note: LBS 16200 F LBS 16200 FA consists of LB 16200 -2 F LBS 16200 S LBS 16200 SA consists of LB 16200 -2 S	LB 16200 C (chromed) LB 16200 F (cast iron) LB 16200 S (cast iron)			KBS 16200 KBS 16200 A	KB 16200 KB 16200 A	KR 16200	PB 16200				

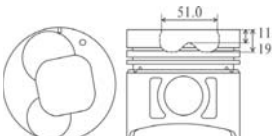

ENGINE TYPE Motortyp/ tipo de motor/ тип двигателя	LINER KIT Liner Kit/ camisas de los cilindros/ Лайнер комплект	CYL. LINER Zylinderlaufbuchse/ camisas de los cilindros/ втулка цилиндра		PISTON + RINGS Kolben + Ringe/ Pistón + Anillos/ поршень и кольца	PISTON SET Kolben Set/ Pistón Set/ поршневой	RINGS SET Ring Set/ Anillos Set/ кольца	PIN Pin/ Perno/ Пин
4BB1 3,595 cc 4 cyl 102.0 mm Bore Ø			Flanged	No flange	Piston	Rings	Ø : 35.0 Length: 87.8
		Length: 204.0 Outside Ø: 105.0 Flange Ø: 112.0 Flange depth: 1.4					
		Reference no.:			Reference no.:	Reference no.:	Reference no.:
		1-11261-118-0 5-11261-004-0 5-11261-118-0			5-12111-013-0	5-12121-004-0 5-12121-005-0 5-12181-003-1 5-12181-024-1 5-45454-004-2	1-12251-027-0 5-12251-006-0 9-12251-602-0
NM-Motorservice Article no./ Artikelnummer/ Modelo número/ статья номер	NM-Motorservice Article no.:	NM-Motorservice Article no.:		NM-Motorservice Article no.:	NM-Motorservice Article no.:	NM-Motorservice Article no.:	NM-Motorservice Article no.:
	LBS 16100 C	LB 16100 C		KBS 16100	KB 16100	KR 16100	PB 16100

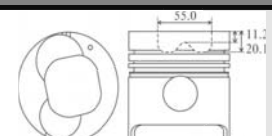

ENGINE TYPE Motortyp/ tipo de motor/ тип двигателя	LINER KIT Liner Kit/ camisas de los cilindros/ Лайнер комплект	CYL. LINER Zylinderlaufbuchse/ camisas de los cilindros/ втулка цилиндра		PISTON + RINGS Kolben + Ringe/ Pistón + Anillos/ поршень и кольца	PISTON SET Kolben Set/ Pistón Set/ поршневой	RINGS SET Ring Set/ Anillos Set/ кольца	PIN Pin/ Perno/ Пин
4BD1 3,856 cc 4 cyl 102.0 mm Bore Ø			chrome	cast iron	Piston	Rings	Ø : 35.0 Length: 87.5
		Length: 204.0 Outside Ø: 105.0 Flange Ø: 112.0 Flange depth: 1.4	204.0 106.0 112.0	4.0			
		Reference no.:			Reference no.:	Reference no.:	Reference no.:
		1-11261-118-0 5-11261-004-0 5-11261-118-0			5-12111-068-0 5-12111-068-2 5-12111-211-0 5-12111-211-1	5-12121-004-0 5-12121-005-0 5-12181-003-1 5-12181-024-1 5-45454-004-2	1-12251-027-0 5-12251-006-0 9-12251-602-0
NM-Motorservice Article no./ Artikelnummer/ Modelo número/ статья номер	NM-Motorservice Article no.:	NM-Motorservice Article no.:		NM-Motorservice Article no.:	NM-Motorservice Article no.:	NM-Motorservice Article no.:	NM-Motorservice Article no.:
	LBS 16250 C LBS 16250 F LBS 16250 S	LB 16250 C LB 16250 F LB 16250 S		KBS 16250	KB 16250	KR 16250	PB 16250



ENGINE TYPE Motortyp/ tipo de motor/ тип двигателя	LINER KIT Liner Kit/ camisas de los cilindros/ Лайнер комплект	CYL. LINER Zylinderlaufbuchse/ camisas de los cilindros/ втулка цилиндра		PISTON + RINGS Kolben + Ringe/ Pistón + Anillos/ поршень и кольца	PISTON SET Kolben Set/ Pistón Set/ поршневой	RINGS SET Ring Set/ Anillos Set/ кольца	PIN Pin/ Perno/ Пин
4BD1 New 3,856 cc 4 cyl 102.0 mm Bore Ø			chrome	cast iron	Piston	Rings	Ø : 35.0 Length: 87.0
		Length: 204.0 Outside Ø: 105.0 Flange Ø: 112.0 Flange depth: 1.4	204.0 106.0 112.0	4.0			
		Reference no.:			Reference no.:	Reference no.:	Reference no.:
		1-11261-118-0 5-11261-004-0 5-11261-118-0			8-94452-912-0	5-12121-004-0 5-12121-005-0 5-12181-003-1 5-12181-024-1 5-45454-004-2	1-12251-027-0 5-12251-006-0 9-12251-602-0
NM-Motorservice Article no./ Artikelnummer/ Modelo número/ статья номер	NM-Motorservice Article no.:	NM-Motorservice Article no.:		NM-Motorservice Article no.:	NM-Motorservice Article no.:	NM-Motorservice Article no.:	NM-Motorservice Article no.:
	LBS 16300 CA LBS 16300 FA LBS 16300 SA	LB 16300 C LB 16300 F LB 16300 S		KBS 16300 A	KB 16300 A	KR 16300	PB 16300

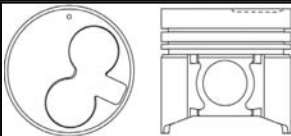

ENGINE TYPE Motor/typo/ tipo de motor/ тип двигателя	LINER KIT Liner Kit/ camisas de los cilindros/ Лайнер комплект	CYL. LINER Zylinderlaufbuchse/ camisas de los cilindros/ втулка цилиндра			PISTON + RINGS Kolben + Ringe/ Pistón + Anillos/ поршень и кольца		PISTON SET Kolben Set/ Pistón Set/ поршневой	RINGS SET Ring Set/ Anillos Set/ кольца		PIN Pin/ Perno/ Пин	
4BD1T			chrome	cast iron	Piston			Rings		Ø : 35.0 Length: 87.0	
					Length: 204.0	204.0		Length: 98.0			
3,856 cc 4 cyl 102.0 mm Bore Ø			Outside Ø: 105.0	106.0	Comp. height: 58.8			2nd: 2.5			
			Flange Ø: 112.0	112.0	height: -11.5			oil: 5.0			
			Flange depth: 1.4	4.0	-19.8						
			Reference no.:					Reference no.:		Reference no.:	
			1-11261-118-0	5-11261-004-0	5-11261-118-0			5-12111-242-1	5-12121-004-0	1-12251-027-0	
							5-12111-265-0	5-12121-005-0	5-12251-006-0		
							5-12111-649-1	5-12181-003-1	9-12251-602-0		
							5-87810-280-3	5-12181-024-1			
							8-94175-027-2	5-45454-004-2			
							8-94321-734-0				
							8-97176-637-0				
NM-Motorservice Article no./ Artikelnummer/ Modelo número/ статья номер	NM-Motorservice Article no.:	NM-Motorservice Article no.:	NM-Motorservice Article no.:		NM-Motorservice Article no.:	NM-Motorservice Article no.:	NM-Motorservice Article no.:	NM-Motorservice Article no.:	NM-Motorservice Article no.:	NM-Motorservice Article no.:	NM-Motorservice Article no.:
	LBS 16350 CA LBS 16350 FA LBS 16350 SA	LB 16350 C LB 16350 F LB 16350 S			KBS 16350 A	KB 16350 A	KB 16350 A	KB 16350 A	KR 16350	PB 16350	PB 16350

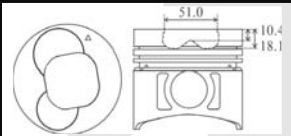

ENGINE TYPE Motor/typo/ tipo de motor/ тип двигателя	LINER KIT Liner Kit/ camisas de los cilindros/ Лайнер комплект	CYL. LINER Zylinderlaufbuchse/ camisas de los cilindros/ втулка цилиндра			PISTON + RINGS Kolben + Ringe/ Pistón + Anillos/ поршень и кольца		PISTON SET Kolben Set/ Pistón Set/ поршневой	RINGS SET Ring Set/ Anillos Set/ кольца		PIN Pin/ Perno/ Пин	
4BD1T			chrome	cast iron	Piston			Rings		Ø : 35.0 Length: 87.5	
					Length: 204.0	204.0		Length: 104.2			
3,856 cc 4 cyl 102.0 mm Bore Ø			Outside Ø: 105.0	106.0	Comp. height: 58.8			2nd: 2.5			
			Flange Ø: 112.0	112.0	height: -11.2			oil: 5.0			
			Flange depth: 1.4	4.0	-20.1						
			Reference no.:					Reference no.:		Reference no.:	
			1-11261-118-0	5-11261-004-0	5-11261-118-0			1-12111-240-1	5-12121-004-0	1-12251-027-0	
							1-12111-303-0	5-12121-005-0	5-12251-006-0		
							1-12111-303-1	5-12181-003-1	9-12251-602-0		
							5-12111-240-1	5-12181-024-1			
							5-12111-303-1	5-45454-004-2			
NM-Motorservice Article no./ Artikelnummer/ Modelo número/ статья номер	NM-Motorservice Article no.:	NM-Motorservice Article no.:	NM-Motorservice Article no.:		NM-Motorservice Article no.:	NM-Motorservice Article no.:	NM-Motorservice Article no.:	NM-Motorservice Article no.:	NM-Motorservice Article no.:	NM-Motorservice Article no.:	NM-Motorservice Article no.:
	LBS 16400 CA LBS 16400 FA LBS 16400 SA	LB 16400 C LB 16400 F LB 16400 S			KBS 16400 A	KB 16400 A	KB 16400 A	KB 16400 A	KR 16400	PB 16400	PB 16400

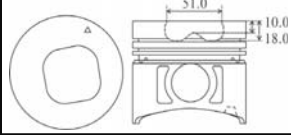

ENGINE TYPE Motor/typo/ tipo de motor/ тип двигателя	LINER KIT Liner Kit/ camisas de los cilindros/ Лайнер комплект	CYL. LINER Zylinderlaufbuchse/ camisas de los cilindros/ втулка цилиндра			PISTON + RINGS Kolben + Ringe/ Pistón + Anillos/ поршень и кольца		PISTON SET Kolben Set/ Pistón Set/ поршневой	RINGS SET Ring Set/ Anillos Set/ кольца		PIN Pin/ Perno/ Пин	
4BD2T (1992-1994)			chrome	cast iron	Piston		Alfin and with oil gallery head anodized	Rings		Ø : 35.0 Length: 87.4	
					Length: 204.0	204.0		Length: 98.1			
3,856 cc 4 cyl 102.0 mm Bore Ø			Outside Ø: 105.0	106.0	Comp. height: 58.7			2nd: 2.5			
			Flange Ø: 112.0	112.0	height: -2.6			oil: 5.0			
			Flange depth: 1.4	4.0							
			Reference no.:					Reference no.:		Reference no.:	
			1-11261-118-0	5-11261-004-0	5-11261-118-0			8-97025-457-2	5-12121-004-0	1-12251-027-0	
							8-97176-640-0	5-12121-005-0	5-12251-006-0		
								5-12181-003-1	9-12251-602-0		
								5-12181-024-1			
								5-45454-004-2			
NM-Motorservice Article no./ Artikelnummer/ Modelo número/ статья номер	NM-Motorservice Article no.:	NM-Motorservice Article no.:	NM-Motorservice Article no.:		NM-Motorservice Article no.:	NM-Motorservice Article no.:	NM-Motorservice Article no.:	NM-Motorservice Article no.:	NM-Motorservice Article no.:	NM-Motorservice Article no.:	NM-Motorservice Article no.:
	LBS 16450 CB LBS 16450 FB LBS 16450 SB	LB 16450 C LB 16450 F LB 16450 S			KBS 16450 B	KB 16450 B	KB 16450 B	KB 16450 B	KR 16450	PB 16450	PB 16450

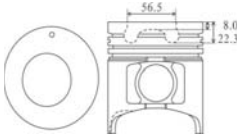

ENGINE TYPE Motortyp/ tipo de motor/ тип двигателя	LINER KIT Liner Kit/ camisas de los cilindros/ Лайнер комплект	CYL. LINER Zylinderlaufbuchse/ camisas de los cilindros/ втулка цилиндра		PISTON + RINGS Kolben + Ringe/ Pistón + Anillos/ поршень и кольца		PISTON SET Kolben Set/ Pistón Set/ поршневой	RINGS SET Ring Set/ Anillos Set/ кольца		PIN Pin/ Perno/ Пин	
4BD2T New (1995-1998) 3,856 cc 4 cyl 102.0 mm Bore Ø		chrome	cast iron	Piston			Rings		Ø : 35.0 Length: 87.5	
		Length: 204.0 Outside Ø: 105.0 Flange Ø: 112.0 Flange depth: 1.4	204.0 106.0 112.0 4.0	Length: 98.1 Comp. height: 58.8 -3.1	Top: 3.0 2nd: 2.0 oil: 4.0					
		Reference no.:				Reference no.:	Reference no.:	Reference no.:		
		1-11261-118-0 5-11261-004-0 5-11261-118-0				8-97176-642-0	8-97117-686-0	1-12251-027-0 5-12251-006-0 9-12251-602-0		
NM-Motorservice Article no./ Artikelnummer/ Modelo número/ статья номер	NM-Motorservice Article no.:	NM-Motorservice Article no.:		NM-Motorservice Article no.:		NM-Motorservice Article no.:	NM-Motorservice Article no.:	NM-Motorservice Article no.:		
	LBS 44150 CB LBS 44150 FB LBS 44150 SB	LB 44150 C LB 44150 F LB 44150 S		KBS 44150 B		KB 44150 B	KR 44150	PB 44150		

ENGINE TYPE Motortyp/ tipo de motor/ тип двигателя	LINER KIT Liner Kit/ camisas de los cilindros/ Лайнер комплект	CYL. LINER Zylinderlaufbuchse/ camisas de los cilindros/ втулка цилиндра		PISTON + RINGS Kolben + Ringe/ Pistón + Anillos/ поршень и кольца		PISTON SET Kolben Set/ Pistón Set/ поршневой	RINGS SET Ring Set/ Anillos Set/ кольца		PIN Pin/ Perno/ Пин	
4BE1 3,636 cc 4 cyl 105.0 mm Bore Ø		Liner/ Sleeve		Piston			Rings		Ø : 35.0 Length: 85.0	
		Length: 187.0 Outside Ø: 107.0 Flange Ø: 113.0 Flange depth: 1.4		Length: 95.6 Comp. height: 56.4 -10.4 -18.1	Top: 3.0 2nd: 2.5 oil: 5.0					
		Reference no.:				Reference no.:	Reference no.:	Reference no.:		
		5-11261-016-2				5-12111-022-0 8-94438-989-1	8-94418-918-0	1-12251-027-0 5-12251-006-0 9-12251-602-0		
NM-Motorservice Article no./ Artikelnummer/ Modelo número/ статья номер	NM-Motorservice Article no.:	NM-Motorservice Article no.:		NM-Motorservice Article no.:		NM-Motorservice Article no.:	NM-Motorservice Article no.:	NM-Motorservice Article no.:		
	LBS 16550 CA	LB 16550 C		KBS 16550 A		KB 16550 A	KR 16550	PB 16550		

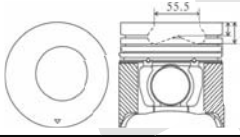
ENGINE TYPE Motortyp/ tipo de motor/ тип двигателя	LINER KIT Liner Kit/ camisas de los cilindros/ Лайнер комплект	CYL. LINER Zylinderlaufbuchse/ camisas de los cilindros/ втулка цилиндра		PISTON + RINGS Kolben + Ringe/ Pistón + Anillos/ поршень и кольца		PISTON SET Kolben Set/ Pistón Set/ поршневой	RINGS SET Ring Set/ Anillos Set/ кольца		PIN Pin/ Perno/ Пин	
4BE1 3,636 cc 4 cyl 105.0 mm Bore Ø		Liner/ Sleeve		Piston			Rings		Ø : 35.0 Length: 85.0	
		Length: 187.0 Outside Ø: 107.0 Flange Ø: 113.0 Flange depth: 1.4		Length: 95.7 Comp. height: 56.5 -10.0 -18.0	Top: 3.0 2nd: 2.5 oil: 5.0					
		Reference no.:				Reference no.:	Reference no.:	Reference no.:		
		5-11261-016-2				8-94478-116-0	8-94418-918-0	1-12251-027-0 5-12251-006-0 9-12251-602-0		
NM-Motorservice Article no./ Artikelnummer/ Modelo número/ статья номер	NM-Motorservice Article no.:	NM-Motorservice Article no.:		NM-Motorservice Article no.:		NM-Motorservice Article no.:	NM-Motorservice Article no.:	NM-Motorservice Article no.:		
	LBS 16600 CA	LB 16600 C		KBS 16600 A		KB 16600 A	KR 16600	PB 16600		

ENGINE TYPE Motortyp/ tipo de motor/ тип двигателя	LINER KIT Liner Kit/ camisas de los cilindros/ Лайнер комплект	CYL. LINER Zylinderlaufbuchse/ camisas de los cilindros/ втулка цилиндра	PISTON + RINGS Kolben + Ringe/ Pistón + Anillos/ поршень и кольца	PISTON SET Kolben Set/ Pistón Set/ поршневой	RINGS SET Ring Set/ Anillos Set/ кольца	PIN Pin/ Perno/ Пин																																								
4HE1T 4,751 cc 4 cyl 110.0 mm Bore Ø	LBS 16650-1 FB LBS 16650-1 SB (Liner OD + 0.25) LBS 16650-2 FB LBS 16650-2 SB (Liner OD + 0.50)	<table border="1"> <tr> <td></td> <td>Liner/ Sleeve</td> <td></td> </tr> <tr> <td>Length:</td> <td>210.0</td> <td></td> </tr> <tr> <td>Outside Ø:</td> <td>115.0</td> <td></td> </tr> <tr> <td>Flange Ø:</td> <td>121.7</td> <td></td> </tr> <tr> <td>Flange depth:</td> <td>5.7 +0.4</td> <td></td> </tr> </table>		Liner/ Sleeve		Length:	210.0		Outside Ø:	115.0		Flange Ø:	121.7		Flange depth:	5.7 +0.4		<table border="1"> <tr> <td></td> <td>Piston</td> <td></td> </tr> <tr> <td>Length:</td> <td>120.0</td> <td></td> </tr> <tr> <td>Comp. height:</td> <td>66.2 -8.0 -22.3</td> <td></td> </tr> </table>		Piston		Length:	120.0		Comp. height:	66.2 -8.0 -22.3		Alfin and with oil gallery	<table border="1"> <tr> <td></td> <td>Rings</td> <td></td> </tr> <tr> <td>Top:</td> <td>3.0</td> <td rowspan="3">Ø : Length:</td> </tr> <tr> <td>2nd:</td> <td>2.5</td> </tr> <tr> <td>oil:</td> <td>4.0</td> </tr> </table>		Rings		Top:	3.0	Ø : Length:	2nd:	2.5	oil:	4.0	<table border="1"> <tr> <td></td> <td>Ø :</td> <td>40.0</td> </tr> <tr> <td></td> <td>Length:</td> <td>87.0</td> </tr> </table>		Ø :	40.0		Length:	87.0
				Liner/ Sleeve																																										
Length:	210.0																																													
Outside Ø:	115.0																																													
Flange Ø:	121.7																																													
Flange depth:	5.7 +0.4																																													
	Piston																																													
Length:	120.0																																													
Comp. height:	66.2 -8.0 -22.3																																													
	Rings																																													
Top:	3.0	Ø : Length:																																												
2nd:	2.5																																													
oil:	4.0																																													
	Ø :	40.0																																												
	Length:	87.0																																												
		Reference no.:		Reference no.:	Reference no.:	Reference no.:																																								
		8-97176-723-0 8-97176-724-0 8-97176-725-0 8-97176-726-0 8-97176-728-0		8-97176-652-0 8-97176-653-0 8-97183-664-0 8-97183-665-0 8-97233-129-0 8-97233-130-0	8-97078-779-0	8-94394-613-0																																								
NM-Motorservice Article no./ Artikelnummer/ Modelo número/ статья номер	NM-Motorservice Article no.:	NM-Motorservice Article no.:	NM-Motorservice Article no.:	NM-Motorservice Article no.:	NM-Motorservice Article no.:	NM-Motorservice Article no.:																																								
	LBS 16650 FB LBS 16650 SB	LB 16650 F (phosphated) LB 16650 S LB 16650 - 1 F+S (Oversized OD + 0.25) LB 16650 - 2 F+S (Oversized OD + 0.50)	KBS 16650 B	KB 16650 B	KR 16650	PB 16650																																								

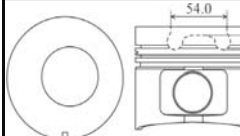
ENGINE TYPE Motortyp/ tipo de motor/ тип двигателя	LINER KIT Liner Kit/ camisas de los cilindros/ Лайнер комплект	CYL. LINER Zylinderlaufbuchse/ camisas de los cilindros/ втулка цилиндра	PISTON + RINGS Kolben + Ringe/ Pistón + Anillos/ поршень и кольца	PISTON SET Kolben Set/ Pistón Set/ поршневой	RINGS SET Ring Set/ Anillos Set/ кольца	PIN Pin/ Perno/ Пин																																								
4HE1-TC 4,751 cc 4 cyl 110.0 mm Bore Ø	LBS 16700-1 FB LBS 16700-1 SB (Liner OD + 0.25) LBS 16700-2 FB LBS 16700-2 SB (Liner OD + 0.50) LBS 16700-3 FB consists of LB 16650 F LBS 16700-3 SB consists of LB 16650 S	<table border="1"> <tr> <td></td> <td>Liner/ Sleeve</td> <td></td> </tr> <tr> <td>Length:</td> <td>210.0</td> <td></td> </tr> <tr> <td>Outside Ø:</td> <td>113.0</td> <td></td> </tr> <tr> <td>Flange Ø:</td> <td>119.7</td> <td></td> </tr> <tr> <td>Flange depth:</td> <td>5.6 +0.4</td> <td></td> </tr> </table>		Liner/ Sleeve		Length:	210.0		Outside Ø:	113.0		Flange Ø:	119.7		Flange depth:	5.6 +0.4		<table border="1"> <tr> <td></td> <td>Piston</td> <td></td> </tr> <tr> <td>Length:</td> <td>110.0</td> <td></td> </tr> <tr> <td>Comp. height:</td> <td>66.2 -14.1 -22.6</td> <td></td> </tr> </table>		Piston		Length:	110.0		Comp. height:	66.2 -14.1 -22.6		Alfin and with oil gallery skirt MOS2 treated	<table border="1"> <tr> <td></td> <td>Rings</td> <td></td> </tr> <tr> <td>Top:</td> <td>3.0</td> <td rowspan="3">Ø : Length:</td> </tr> <tr> <td>2nd:</td> <td>2.0</td> </tr> <tr> <td>oil:</td> <td>1.2 3.0</td> </tr> </table>		Rings		Top:	3.0	Ø : Length:	2nd:	2.0	oil:	1.2 3.0	<table border="1"> <tr> <td></td> <td>Ø :</td> <td>40.0</td> </tr> <tr> <td></td> <td>Length:</td> <td>87.0</td> </tr> </table>		Ø :	40.0		Length:	87.0
				Liner/ Sleeve																																										
Length:	210.0																																													
Outside Ø:	113.0																																													
Flange Ø:	119.7																																													
Flange depth:	5.6 +0.4																																													
	Piston																																													
Length:	110.0																																													
Comp. height:	66.2 -14.1 -22.6																																													
	Rings																																													
Top:	3.0	Ø : Length:																																												
2nd:	2.0																																													
oil:	1.2 3.0																																													
	Ø :	40.0																																												
	Length:	87.0																																												
		Reference no.:		Reference no.:	Reference no.:	Reference no.:																																								
		8-94391-600-0 8-94391-601-0		8-94391-696-0	8-97166-992-0	8-94394-613-0																																								
NM-Motorservice Article no./ Artikelnummer/ Modelo número/ статья номер	NM-Motorservice Article no.:	LB 16700 F (phosphated) LB 16700 S LB 16700 - 1 F+S (Oversized OD + 0.25) LB 16700 - 2 F+S (Oversized OD + 0.50)	NM-Motorservice Article no.:	NM-Motorservice Article no.:	NM-Motorservice Article no.:	NM-Motorservice Article no.:																																								
	LBS 16700 FB LBS 16700 SB		KBS 16700 B	KB 16700 B	KR 16700	PB 16700																																								

ENGINE TYPE Motortyp/ tipo de motor/ тип двигателя	LINER KIT Liner Kit/ camisas de los cilindros/ Лайнер комплект	CYL. LINER Zylinderlaufbuchse/ camisas de los cilindros/ втулка цилиндра	PISTON + RINGS Kolben + Ringe/ Pistón + Anillos/ поршень и кольца	PISTON SET Kolben Set/ Pistón Set/ поршневой	RINGS SET Ring Set/ Anillos Set/ кольца	PIN Pin/ Perno/ Пин																																								
4HF1 4,334 cc 4 cyl 112.0 mm Bore Ø		<table border="1"> <tr> <td></td> <td>Liner/ Sleeve</td> <td></td> </tr> <tr> <td>Length:</td> <td>180.0</td> <td></td> </tr> <tr> <td>Outside Ø:</td> <td>115.0</td> <td></td> </tr> <tr> <td>Flange Ø:</td> <td>121.7</td> <td></td> </tr> <tr> <td>Flange depth:</td> <td>6.1</td> <td></td> </tr> </table>		Liner/ Sleeve		Length:	180.0		Outside Ø:	115.0		Flange Ø:	121.7		Flange depth:	6.1		<table border="1"> <tr> <td></td> <td>Piston</td> <td></td> </tr> <tr> <td>Length:</td> <td>94.5</td> <td></td> </tr> <tr> <td>Comp. height:</td> <td>60.8 -8.4 -21.7</td> <td></td> </tr> </table>		Piston		Length:	94.5		Comp. height:	60.8 -8.4 -21.7			<table border="1"> <tr> <td></td> <td>Rings</td> <td></td> </tr> <tr> <td>Top:</td> <td>3.0</td> <td rowspan="3">Ø : Length:</td> </tr> <tr> <td>2nd:</td> <td>2.5</td> </tr> <tr> <td>oil:</td> <td>4.0</td> </tr> </table>		Rings		Top:	3.0	Ø : Length:	2nd:	2.5	oil:	4.0	<table border="1"> <tr> <td></td> <td>Ø :</td> <td>36.0</td> </tr> <tr> <td></td> <td>Length:</td> <td>79.0</td> </tr> </table>		Ø :	36.0		Length:	79.0
				Liner/ Sleeve																																										
Length:	180.0																																													
Outside Ø:	115.0																																													
Flange Ø:	121.7																																													
Flange depth:	6.1																																													
	Piston																																													
Length:	94.5																																													
Comp. height:	60.8 -8.4 -21.7																																													
	Rings																																													
Top:	3.0	Ø : Length:																																												
2nd:	2.5																																													
oil:	4.0																																													
	Ø :	36.0																																												
	Length:	79.0																																												
		Reference no.:		Reference no.:	Reference no.:	Reference no.:																																								
		8-97144-174-0 8-97176-727-0 8-97176-728-0		8-97095-585-1 8-97176-655-0	8-97028-691-0	1-12251-036-0																																								
NM-Motorservice Article no./ Artikelnummer/ Modelo número/ статья номер	NM-Motorservice Article no.:	LB 16750 F (phosphated) LB 16750 S LB 16750 - 1 F+S (Oversized OD + 0.25) LB 16750 - 2 F+S (Oversized OD + 0.50)	NM-Motorservice Article no.:	NM-Motorservice Article no.:	NM-Motorservice Article no.:	NM-Motorservice Article no.:																																								
	LBS 16750 FA LBS 16750 SA		KBS 16750 A	KB 16750 A	KR 16750	PB 16750																																								



ENGINE TYPE Motortyp/ tipo de motor/ тип двигателя	LINER KIT Liner Kit/ camisas de los cilindros/ Лайнер комплект	CYL. LINER Zylinderlaufbuchse/ camisas de los cilindros/ втулка цилиндра	PISTON + RINGS Kolben + Ringe/ Pistón + Anillos/ поршень и кольца	PISTON SET Kolben Set/ Pistón Set/ поршневой	RINGS SET Ring Set/ Anillos Set/ кольца	PIN Pin/ Perno/ Пин																																										
4HF1 4,334 cc 4 cyl 112.0 mm Bore Ø		<table border="1"> <tr> <td></td> <td>Liner/ Sleeve</td> <td></td> </tr> <tr> <td>Length:</td> <td>180.0</td> <td></td> </tr> <tr> <td>Outside Ø:</td> <td>115.0</td> <td></td> </tr> <tr> <td>Flange Ø:</td> <td>121.7</td> <td></td> </tr> <tr> <td>Flange depth:</td> <td>6.1</td> <td></td> </tr> </table>		Liner/ Sleeve		Length:	180.0		Outside Ø:	115.0		Flange Ø:	121.7		Flange depth:	6.1		<table border="1"> <tr> <td></td> <td>Piston</td> <td></td> </tr> <tr> <td>Length:</td> <td>94.5</td> <td></td> </tr> <tr> <td>Comp. height:</td> <td>60.8</td> <td></td> </tr> <tr> <td></td> <td>-9.3</td> <td></td> </tr> <tr> <td></td> <td>-18.3</td> <td></td> </tr> </table>		Piston		Length:	94.5		Comp. height:	60.8			-9.3			-18.3			<table border="1"> <tr> <td></td> <td>Rings</td> <td></td> </tr> <tr> <td>Top:</td> <td>3.0</td> <td rowspan="3"> Ø : 36.0 Length: 79.0 </td> </tr> <tr> <td>2nd:</td> <td>2.5</td> </tr> <tr> <td>oil:</td> <td>4.0</td> </tr> </table>		Rings		Top:	3.0	Ø : 36.0 Length: 79.0	2nd:	2.5	oil:	4.0			
			Liner/ Sleeve																																													
		Length:	180.0																																													
Outside Ø:	115.0																																															
Flange Ø:	121.7																																															
Flange depth:	6.1																																															
	Piston																																															
Length:	94.5																																															
Comp. height:	60.8																																															
	-9.3																																															
	-18.3																																															
	Rings																																															
Top:	3.0	Ø : 36.0 Length: 79.0																																														
2nd:	2.5																																															
oil:	4.0																																															
<table border="1"> <tr> <td>Reference no.:</td> <td></td> <td></td> </tr> <tr> <td>8-97144-174-0</td> <td></td> <td></td> </tr> <tr> <td>8-97176-727-0</td> <td></td> <td></td> </tr> <tr> <td>8-97176-728-0</td> <td></td> <td></td> </tr> </table>	Reference no.:			8-97144-174-0			8-97176-727-0			8-97176-728-0			<table border="1"> <tr> <td>Reference no.:</td> <td></td> <td></td> </tr> <tr> <td>8-97063-867-0</td> <td></td> <td></td> </tr> <tr> <td>8-97095-654-0</td> <td></td> <td></td> </tr> </table>	Reference no.:			8-97063-867-0			8-97095-654-0			<table border="1"> <tr> <td>Reference no.:</td> <td></td> <td></td> </tr> <tr> <td>8-97028-691-0</td> <td></td> <td></td> </tr> </table>	Reference no.:			8-97028-691-0			<table border="1"> <tr> <td>Reference no.:</td> <td></td> <td></td> </tr> <tr> <td>1-12251-036-0</td> <td></td> <td></td> </tr> </table>	Reference no.:			1-12251-036-0														
Reference no.:																																																
8-97144-174-0																																																
8-97176-727-0																																																
8-97176-728-0																																																
Reference no.:																																																
8-97063-867-0																																																
8-97095-654-0																																																
Reference no.:																																																
8-97028-691-0																																																
Reference no.:																																																
1-12251-036-0																																																
NM-Motorservice Article no./ Artikelnummer/ Modelo número/ статья номер	NM-Motorservice Article no.:	NM-Motorservice Article no.:	NM-Motorservice Article no.:	NM-Motorservice Article no.:	NM-Motorservice Article no.:	NM-Motorservice Article no.:																																										
	LBS 16800 FA LBS 16800 SA	LB 16800 F (phosphated) LB 16800 S LB 16800 - 1 F+S (Oversized OD + 0.25) LB 16800 - 2 F+S (Oversized OD + 0.50)	KBS 16800 A	KB 16800 A	KR 16800	PB 16800																																										
4HF1 New 4,334 cc 4 cyl 112.0 mm Bore Ø		<table border="1"> <tr> <td></td> <td>Liner/ Sleeve</td> <td></td> </tr> <tr> <td>Length:</td> <td>180.0</td> <td></td> </tr> <tr> <td>Outside Ø:</td> <td>115.0</td> <td></td> </tr> <tr> <td>Flange Ø:</td> <td>121.7</td> <td></td> </tr> <tr> <td>Flange depth:</td> <td>6.1</td> <td></td> </tr> </table>		Liner/ Sleeve		Length:	180.0		Outside Ø:	115.0		Flange Ø:	121.7		Flange depth:	6.1		<table border="1"> <tr> <td></td> <td>Piston</td> <td></td> </tr> <tr> <td>Length:</td> <td>94.5</td> <td></td> </tr> <tr> <td>Comp. height:</td> <td>60.8</td> <td></td> </tr> <tr> <td></td> <td>-9.2</td> <td></td> </tr> <tr> <td></td> <td>-22.1</td> <td></td> </tr> </table>		Piston		Length:	94.5		Comp. height:	60.8			-9.2			-22.1			<table border="1"> <tr> <td></td> <td>Rings</td> <td></td> </tr> <tr> <td>Top:</td> <td>3.0</td> <td rowspan="3"> Ø : 36.0 Length: 79.0 </td> </tr> <tr> <td>2nd:</td> <td>2.5</td> </tr> <tr> <td>oil:</td> <td>4.0</td> </tr> </table>		Rings		Top:	3.0	Ø : 36.0 Length: 79.0	2nd:	2.5	oil:	4.0			
			Liner/ Sleeve																																													
		Length:	180.0																																													
Outside Ø:	115.0																																															
Flange Ø:	121.7																																															
Flange depth:	6.1																																															
	Piston																																															
Length:	94.5																																															
Comp. height:	60.8																																															
	-9.2																																															
	-22.1																																															
	Rings																																															
Top:	3.0	Ø : 36.0 Length: 79.0																																														
2nd:	2.5																																															
oil:	4.0																																															
<table border="1"> <tr> <td>Reference no.:</td> <td></td> <td></td> </tr> <tr> <td>8-97144-174-0</td> <td></td> <td></td> </tr> <tr> <td>8-97176-727-0</td> <td></td> <td></td> </tr> <tr> <td>8-97176-728-0</td> <td></td> <td></td> </tr> </table>	Reference no.:			8-97144-174-0			8-97176-727-0			8-97176-728-0			<table border="1"> <tr> <td>Reference no.:</td> <td></td> <td></td> </tr> <tr> <td>5-87813-391-0</td> <td></td> <td></td> </tr> <tr> <td>5-87813-391-1</td> <td></td> <td></td> </tr> </table>	Reference no.:			5-87813-391-0			5-87813-391-1			<table border="1"> <tr> <td>Reference no.:</td> <td></td> <td></td> </tr> <tr> <td>8-97109-462-0</td> <td></td> <td></td> </tr> </table>	Reference no.:			8-97109-462-0			<table border="1"> <tr> <td>Reference no.:</td> <td></td> <td></td> </tr> <tr> <td>1-12251-036-0</td> <td></td> <td></td> </tr> </table>	Reference no.:			1-12251-036-0														
Reference no.:																																																
8-97144-174-0																																																
8-97176-727-0																																																
8-97176-728-0																																																
Reference no.:																																																
5-87813-391-0																																																
5-87813-391-1																																																
Reference no.:																																																
8-97109-462-0																																																
Reference no.:																																																
1-12251-036-0																																																
NM-Motorservice Article no./ Artikelnummer/ Modelo número/ статья номер	NM-Motorservice Article no.:	NM-Motorservice Article no.:	NM-Motorservice Article no.:	NM-Motorservice Article no.:	NM-Motorservice Article no.:	NM-Motorservice Article no.:																																										
	LBS 16850 FA LBS 16850 SA	LB 16850 F (phosphated) LB 16850 S LB 16850 - 1 F+S (Oversized OD + 0.25) LB 16850 - 2 F+S (Oversized OD + 0.50)	KBS 16850 A	KB 16850 A	KR 16850	PB 16850																																										
4HG1 4,751 cc 4 cyl 115.0 mm Bore Ø		<table border="1"> <tr> <td></td> <td>Liner/ Sleeve</td> <td></td> </tr> <tr> <td>Length:</td> <td>180.0</td> <td></td> </tr> <tr> <td>Outside Ø:</td> <td>118.0</td> <td></td> </tr> <tr> <td>Flange Ø:</td> <td>123.6</td> <td></td> </tr> <tr> <td>Flange depth:</td> <td>6.1</td> <td></td> </tr> </table>		Liner/ Sleeve		Length:	180.0		Outside Ø:	118.0		Flange Ø:	123.6		Flange depth:	6.1		<table border="1"> <tr> <td></td> <td>Piston</td> <td></td> </tr> <tr> <td>Length:</td> <td>119.4</td> <td></td> </tr> <tr> <td>Comp. height:</td> <td>60.7</td> <td></td> </tr> <tr> <td></td> <td>-9.3</td> <td></td> </tr> <tr> <td></td> <td>-22.0</td> <td></td> </tr> </table>		Piston		Length:	119.4		Comp. height:	60.7			-9.3			-22.0		Alfin skirt MOS2 treated	<table border="1"> <tr> <td></td> <td>Rings</td> <td></td> </tr> <tr> <td>Top:</td> <td>3.0</td> <td rowspan="3"> Ø : 36.0 Length: 79.0 </td> </tr> <tr> <td>2nd:</td> <td>2.5</td> </tr> <tr> <td>oil:</td> <td>4.0</td> </tr> </table>		Rings		Top:	3.0	Ø : 36.0 Length: 79.0	2nd:	2.5	oil:	4.0			
			Liner/ Sleeve																																													
		Length:	180.0																																													
Outside Ø:	118.0																																															
Flange Ø:	123.6																																															
Flange depth:	6.1																																															
	Piston																																															
Length:	119.4																																															
Comp. height:	60.7																																															
	-9.3																																															
	-22.0																																															
	Rings																																															
Top:	3.0	Ø : 36.0 Length: 79.0																																														
2nd:	2.5																																															
oil:	4.0																																															
<table border="1"> <tr> <td>Reference no.:</td> <td></td> <td></td> </tr> <tr> <td>8-97176-729-0</td> <td></td> <td></td> </tr> <tr> <td>8-97176-730-0</td> <td></td> <td></td> </tr> <tr> <td>8-97351-558-0/1</td> <td></td> <td></td> </tr> <tr> <td>8-97351-559-0/1</td> <td></td> <td></td> </tr> <tr> <td>8-98014-048-0</td> <td></td> <td></td> </tr> <tr> <td>8-98014-049-0</td> <td></td> <td></td> </tr> </table>	Reference no.:			8-97176-729-0			8-97176-730-0			8-97351-558-0/1			8-97351-559-0/1			8-98014-048-0			8-98014-049-0			<table border="1"> <tr> <td>Reference no.:</td> <td></td> <td></td> </tr> <tr> <td>8-97221-484-0</td> <td></td> <td></td> </tr> </table>	Reference no.:			8-97221-484-0			<table border="1"> <tr> <td>Reference no.:</td> <td></td> <td></td> </tr> <tr> <td>8-97105-867-0</td> <td></td> <td></td> </tr> <tr> <td>8-97219-054-0</td> <td></td> <td></td> </tr> <tr> <td>8-98055-478-0</td> <td></td> <td></td> </tr> </table>	Reference no.:			8-97105-867-0			8-97219-054-0			8-98055-478-0			<table border="1"> <tr> <td>Reference no.:</td> <td></td> <td></td> </tr> <tr> <td>1-12251-036-0</td> <td></td> <td></td> </tr> </table>	Reference no.:			1-12251-036-0		
Reference no.:																																																
8-97176-729-0																																																
8-97176-730-0																																																
8-97351-558-0/1																																																
8-97351-559-0/1																																																
8-98014-048-0																																																
8-98014-049-0																																																
Reference no.:																																																
8-97221-484-0																																																
Reference no.:																																																
8-97105-867-0																																																
8-97219-054-0																																																
8-98055-478-0																																																
Reference no.:																																																
1-12251-036-0																																																
NM-Motorservice Article no./ Artikelnummer/ Modelo número/ статья номер	NM-Motorservice Article no.:	NM-Motorservice Article no.:	NM-Motorservice Article no.:	NM-Motorservice Article no.:	NM-Motorservice Article no.:	NM-Motorservice Article no.:																																										
	LBS 16900 FA LBS 16900 SA	LB 16900 F (phosphated) LB 16900 S LB 16900 - 1 F+S (Oversized OD + 0.25) LB 16900 - 2 F+S (Oversized OD + 0.50)	KBS 16900 A	KB 16900 A	KR 16900	PB 16900																																										



ENGINE TYPE Motor/typo/ tipo de motor/ тип двигателя	LINER KIT Liner Kit/ camisas de los cilindros/ Лайнер комплект	CYL. LINER Zylinderlaufbuchse/ camisas de los cilindros/ втулка цилиндра	PISTON + RINGS Kolben + Ringe/ Pistón + Anillos/ поршень и кольца		PISTON SET Kolben Set/ Pistón Set/ поршневой	RINGS SET Ring Set/ Anillos Set/ кольца	PIN Pin/ Perno/ Пин																														
4HG1 4,751 cc 4 cyl 115.0 mm Bore Ø		<table border="1"> <tr> <td></td> <td>Liner/ Sleeve</td> <td></td> </tr> <tr> <td>Length:</td> <td>180.0</td> <td></td> </tr> <tr> <td>Outside Ø:</td> <td>118.0</td> <td></td> </tr> <tr> <td>Flange Ø:</td> <td>123.6</td> <td></td> </tr> <tr> <td>Flange depth:</td> <td>6.1</td> <td></td> </tr> </table>		Liner/ Sleeve		Length:	180.0		Outside Ø:	118.0		Flange Ø:	123.6		Flange depth:	6.1		<table border="1"> <tr> <td></td> <td>Piston</td> </tr> <tr> <td>Length:</td> <td>104.5</td> </tr> <tr> <td>Comp. height:</td> <td>60.7 -9.8 -22.0</td> </tr> </table>			Piston	Length:	104.5	Comp. height:	60.7 -9.8 -22.0		<table border="1"> <tr> <td></td> <td>Rings</td> </tr> <tr> <td>Top: 2nd: oil:</td> <td>3.0 2.5 4.0</td> </tr> <tr> <td>Ø:</td> <td>36.0</td> </tr> <tr> <td>Length:</td> <td>79.0</td> </tr> </table>			Rings	Top: 2nd: oil:	3.0 2.5 4.0	Ø:	36.0	Length:	79.0	
				Liner/ Sleeve																																	
Length:	180.0																																				
Outside Ø:	118.0																																				
Flange Ø:	123.6																																				
Flange depth:	6.1																																				
	Piston																																				
Length:	104.5																																				
Comp. height:	60.7 -9.8 -22.0																																				
	Rings																																				
Top: 2nd: oil:	3.0 2.5 4.0																																				
Ø:	36.0																																				
Length:	79.0																																				
	Reference no.:	Reference no.:		Reference no.:	Reference no.:																																
NM-Motorservice Article no./ Artikelnummer/ Modelo número/ статья номер	NM-Motorservice Article no.:	NM-Motorservice Article no.:	N8-97176-729-0 8-97176-730-0 8-97351-558-0/1 8-97351-559-0/1 8-98014-048-0 8-98014-049-0		NM-Motorservice Article no.:	8-97183-666-0	8-97105-867-0 8-97219-054-0 8-98055-478-0	NM-Motorservice Article no.:	1-12251-036-0																												
	LBS 16950 FA LBS 16950 SA	LB 16950 F (phosphated) LB 16950 S LB 16950 - 1 F+S (Oversized OD + 0.25) LB 16950 - 2 F+S (Oversized OD + 0.50)	KBS 16950 A		KB 16950 A	KR 16950	PB 16950																														

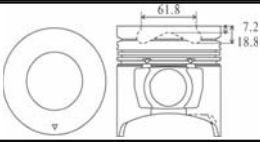

ENGINE TYPE Motor/typo/ tipo de motor/ тип двигателя	LINER KIT Liner Kit/ camisas de los cilindros/ Лайнер комплект	CYL. LINER Zylinderlaufbuchse/ camisas de los cilindros/ втулка цилиндра	PISTON + RINGS Kolben + Ringe/ Pistón + Anillos/ поршень и кольца		PISTON SET Kolben Set/ Pistón Set/ поршневой	RINGS SET Ring Set/ Anillos Set/ кольца	PIN Pin/ Perno/ Пин																														
4HG1/ 4HG1T 4,751 cc 4 cyl 115.0 mm Bore Ø		<table border="1"> <tr> <td></td> <td>Liner/ Sleeve</td> <td></td> </tr> <tr> <td>Length:</td> <td>180.0</td> <td></td> </tr> <tr> <td>Outside Ø:</td> <td>118.0</td> <td></td> </tr> <tr> <td>Flange Ø:</td> <td>123.6</td> <td></td> </tr> <tr> <td>Flange depth:</td> <td>6.1</td> <td></td> </tr> </table>		Liner/ Sleeve		Length:	180.0		Outside Ø:	118.0		Flange Ø:	123.6		Flange depth:	6.1		<table border="1"> <tr> <td></td> <td>Piston</td> </tr> <tr> <td>Length:</td> <td>119.4</td> </tr> <tr> <td>Comp. height:</td> <td>60.7 -9.0 -22.5</td> </tr> </table>			Piston	Length:	119.4	Comp. height:	60.7 -9.0 -22.5	Alfin and with oil gallery	<table border="1"> <tr> <td></td> <td>Rings</td> </tr> <tr> <td>Top: 2nd: oil:</td> <td>3.0 2.5 4.0</td> </tr> <tr> <td>Ø:</td> <td>36.0</td> </tr> <tr> <td>Length:</td> <td>79.0</td> </tr> </table>			Rings	Top: 2nd: oil:	3.0 2.5 4.0	Ø:	36.0	Length:	79.0	
				Liner/ Sleeve																																	
Length:	180.0																																				
Outside Ø:	118.0																																				
Flange Ø:	123.6																																				
Flange depth:	6.1																																				
	Piston																																				
Length:	119.4																																				
Comp. height:	60.7 -9.0 -22.5																																				
	Rings																																				
Top: 2nd: oil:	3.0 2.5 4.0																																				
Ø:	36.0																																				
Length:	79.0																																				
	Reference no.:	Reference no.:		Reference no.:	Reference no.:																																
NM-Motorservice Article no./ Artikelnummer/ Modelo número/ статья номер	NM-Motorservice Article no.:	NM-Motorservice Article no.:	8-97176-729-0 8-97176-730-0 8-97351-558-0/1 8-97351-559-0/1 8-98014-048-0 8-98014-049-0		NM-Motorservice Article no.:	8-97219-032-0	8-97105-867-0 8-97219-054-0 8-98055-478-0	NM-Motorservice Article no.:	1-12251-036-0																												
	LBS 30450 FB LBS 30450 SB	LB 30450 F (phosphated) LB 30450 S LB 30450 - 1 F+S (Oversized OD + 0.25) LB 30450 - 2 F+S (Oversized OD + 0.50)	KBS 30450 B		KB 30450 B	KR 30450	PB 30450																														

ENGINE TYPE Motor/typo/ tipo de motor/ тип двигателя	LINER KIT Liner Kit/ camisas de los cilindros/ Лайнер комплект	CYL. LINER Zylinderlaufbuchse/ camisas de los cilindros/ втулка цилиндра	PISTON + RINGS Kolben + Ringe/ Pistón + Anillos/ поршень и кольца		PISTON SET Kolben Set/ Pistón Set/ поршневой	RINGS SET Ring Set/ Anillos Set/ кольца	PIN Pin/ Perno/ Пин																														
4HK1-TC (NPR NQR) 2006- 5,193 cc 4 cyl 115.0 mm Bore Ø	OD is graded as A and B	<table border="1"> <tr> <td></td> <td>Liner/ Sleeve</td> <td></td> </tr> <tr> <td>Length:</td> <td>210.0</td> <td></td> </tr> <tr> <td>Outside Ø:</td> <td>118.0</td> <td></td> </tr> <tr> <td>Flange Ø:</td> <td>123.7</td> <td></td> </tr> <tr> <td>Flange depth:</td> <td>6.0</td> <td></td> </tr> </table>		Liner/ Sleeve		Length:	210.0		Outside Ø:	118.0		Flange Ø:	123.7		Flange depth:	6.0		<table border="1"> <tr> <td></td> <td>Piston</td> </tr> <tr> <td>Length:</td> <td>96.5</td> </tr> <tr> <td>Comp. height:</td> <td>66.1 -7.2 -18.7</td> </tr> </table>			Piston	Length:	96.5	Comp. height:	66.1 -7.2 -18.7	Alfin and with oil gallery skirt MOS2 treated	<table border="1"> <tr> <td></td> <td>Rings</td> </tr> <tr> <td>Top: 2nd: oil:</td> <td>3.0 2.5 4.0</td> </tr> <tr> <td>Ø:</td> <td>40.0</td> </tr> <tr> <td>Length:</td> <td>87.0</td> </tr> </table>			Rings	Top: 2nd: oil:	3.0 2.5 4.0	Ø:	40.0	Length:	87.0	
				Liner/ Sleeve																																	
Length:	210.0																																				
Outside Ø:	118.0																																				
Flange Ø:	123.7																																				
Flange depth:	6.0																																				
	Piston																																				
Length:	96.5																																				
Comp. height:	66.1 -7.2 -18.7																																				
	Rings																																				
Top: 2nd: oil:	3.0 2.5 4.0																																				
Ø:	40.0																																				
Length:	87.0																																				
	Reference no.:	Reference no.:	Reference no.:		Reference no.:																																
NM-Motorservice Article no./ Artikelnummer/ Modelo número/ статья номер	NM-Motorservice Article no.:	NM-Motorservice Article no.:	1-87813-119-0 5-87814-990-0 5-87814-991-0		NM-Motorservice Article no.:	8-98041-141-0	8-97105-867-0 8-97219-054-0 8-98055-478-0	NM-Motorservice Article no.:	8-94391-794-0																												
	LBS 17050 FB LBS 17050 SB	LB 17050 F (phosphated) LB 17050 S LB 17050 - 1 F+S (Oversized OD + 0.25) LB 17050 - 2 F+S (Oversized OD + 0.50)	KBS 17050 B		KB 17050 B	KR 17050	PB 17050																														

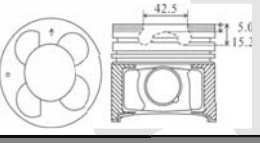
ENGINE TYPE Motortyp/ tipo de motor/ тип двигателя	LINER KIT Liner Kit/ camisas de los cilindros/ Лайнер комплект	CYL. LINER Zylinderlaufbuchse/ camisas de los cilindros/ втулка цилиндра	PISTON + RINGS Kolben + Ringe/ Pistón + Anillos/ поршень и кольца	PISTON SET Kolben Set/ Pistón Set/ поршневой	RINGS SET Ring Set/ Anillos Set/ кольца	PIN Pin/ Perno/ Пин																																					
4HK1-TC	OD is graded as A and B	<table border="1"> <tr> <td></td> <td>Liner/ Sleeve</td> <td></td> </tr> <tr> <td>Length:</td> <td>210.0</td> <td></td> </tr> <tr> <td>Outside Ø:</td> <td>118.0</td> <td></td> </tr> <tr> <td>Flange Ø:</td> <td>123.7</td> <td></td> </tr> <tr> <td>Flange depth:</td> <td>6.0</td> <td></td> </tr> </table>		Liner/ Sleeve		Length:	210.0		Outside Ø:	118.0		Flange Ø:	123.7		Flange depth:	6.0		<table border="1"> <tr> <td></td> <td>Piston</td> </tr> <tr> <td>Length:</td> <td>119.8</td> </tr> <tr> <td>Comp. height:</td> <td>66.0</td> </tr> <tr> <td></td> <td>-9.6</td> </tr> <tr> <td></td> <td>-24.0</td> </tr> </table>		Piston	Length:	119.8	Comp. height:	66.0		-9.6		-24.0	Alfin and with oil gallery skirt MOS2 treated	<table border="1"> <tr> <td colspan="2">Rings</td> </tr> <tr> <td>Top:</td> <td>3.0</td> </tr> <tr> <td>2nd:</td> <td>2.5</td> </tr> <tr> <td>oil:</td> <td>4.0</td> </tr> </table>	Rings		Top:	3.0	2nd:	2.5	oil:	4.0	<table border="1"> <tr> <td>Ø:</td> <td>40.0</td> </tr> <tr> <td>Length:</td> <td>87.0</td> </tr> </table>	Ø:	40.0	Length:	87.0
				Liner/ Sleeve																																							
Length:	210.0																																										
Outside Ø:	118.0																																										
Flange Ø:	123.7																																										
Flange depth:	6.0																																										
	Piston																																										
Length:	119.8																																										
Comp. height:	66.0																																										
	-9.6																																										
	-24.0																																										
Rings																																											
Top:	3.0																																										
2nd:	2.5																																										
oil:	4.0																																										
Ø:	40.0																																										
Length:	87.0																																										
5,193 cc 4 cyl 115.0 mm Bore Ø																																											
NM-Motorservice Article no./ Artikelnummer/ Modelo número/ статья номер	NM-Motorservice Article no.:	Reference no.:		Reference no.:	Reference no.:	Reference no.:																																					
		8-98014-046-0 8-98014-047-0		8-97228-303-0	8-97105-867-0 8-97219-054-0 8-98055-478-0	8-94391-794-0																																					
		NM-Motorservice Article no.:																																									
		LB 17100 F (phosphated) LB 17100 S LB 17100 - 1 F+S (Oversized OD + 0.25) LB 17100 - 2 F+S (Oversized OD + 0.50)	NM-Motorservice Article no.:	NM-Motorservice Article no.:	NM-Motorservice Article no.:	NM-Motorservice Article no.:																																					
	LBS 17100 FB LBS 17100 SB		KBS 17100 B	KB 17100 B	KR 17100	PB 17100																																					
4HJ1	Liner Kit/ camisas de los cilindros/ Лайнер комплект	<table border="1"> <tr> <td></td> <td>Liner/ Sleeve</td> <td></td> </tr> <tr> <td>Length:</td> <td>200.0</td> <td></td> </tr> <tr> <td>Outside Ø:</td> <td>118.0</td> <td></td> </tr> <tr> <td>Flange Ø:</td> <td>123.7</td> <td></td> </tr> <tr> <td>Flange depth:</td> <td>6.0</td> <td></td> </tr> </table>		Liner/ Sleeve		Length:	200.0		Outside Ø:	118.0		Flange Ø:	123.7		Flange depth:	6.0		<table border="1"> <tr> <td></td> <td>Piston</td> </tr> <tr> <td>Length:</td> <td>122.5</td> </tr> <tr> <td>Comp. height:</td> <td>68.7</td> </tr> <tr> <td></td> <td>-9.5</td> </tr> <tr> <td></td> <td>-24.0</td> </tr> </table>		Piston	Length:	122.5	Comp. height:	68.7		-9.5		-24.0	Alfin and with oil gallery skirt MOS2 treated	<table border="1"> <tr> <td colspan="2">Rings</td> </tr> <tr> <td>Top:</td> <td>3.0</td> </tr> <tr> <td>2nd:</td> <td>2.5</td> </tr> <tr> <td>oil:</td> <td>4.0</td> </tr> </table>	Rings		Top:	3.0	2nd:	2.5	oil:	4.0	<table border="1"> <tr> <td>Ø:</td> <td>36.0</td> </tr> <tr> <td>Length:</td> <td>79.0</td> </tr> </table>	Ø:	36.0	Length:	79.0
				Liner/ Sleeve																																							
Length:	200.0																																										
Outside Ø:	118.0																																										
Flange Ø:	123.7																																										
Flange depth:	6.0																																										
	Piston																																										
Length:	122.5																																										
Comp. height:	68.7																																										
	-9.5																																										
	-24.0																																										
Rings																																											
Top:	3.0																																										
2nd:	2.5																																										
oil:	4.0																																										
Ø:	36.0																																										
Length:	79.0																																										
4,985 cc 4 cyl 115.0 mm Bore Ø																																											
NM-Motorservice Article no./ Artikelnummer/ Modelo número/ статья номер	NM-Motorservice Article no.:	Reference no.:		Reference no.:	Reference no.:	Reference no.:																																					
				8-97228-302-0	8-97105-867-0 8-97219-054-0 8-98055-478-0	1-12251-036-0																																					
		NM-Motorservice Article no.:																																									
		LB 17150 F (phosphated) LB 17150 S LB 17150 - 1 F+S (Oversized OD + 0.25) LB 17150 - 2 F+S (Oversized OD + 0.50)	NM-Motorservice Article no.:	NM-Motorservice Article no.:	NM-Motorservice Article no.:	NM-Motorservice Article no.:																																					
	LBS 17150 FB LBS 17150 SB		KBS 17150 B	KB 17150 B	KR 17150	PB 17150																																					
4HL1	Liner Kit/ camisas de los cilindros/ Лайнер комплект	<table border="1"> <tr> <td></td> <td>Liner/ Sleeve</td> <td></td> </tr> <tr> <td>Length:</td> <td>190.0</td> <td></td> </tr> <tr> <td>Outside Ø:</td> <td>118.0</td> <td></td> </tr> <tr> <td>Flange Ø:</td> <td>123.7</td> <td></td> </tr> <tr> <td>Flange depth:</td> <td>6.0</td> <td></td> </tr> </table>		Liner/ Sleeve		Length:	190.0		Outside Ø:	118.0		Flange Ø:	123.7		Flange depth:	6.0		<table border="1"> <tr> <td></td> <td>Piston</td> </tr> <tr> <td>Length:</td> <td>112.0</td> </tr> <tr> <td>Comp. height:</td> <td>58.2</td> </tr> <tr> <td></td> <td>-4.9</td> </tr> <tr> <td></td> <td>-21.0</td> </tr> </table>		Piston	Length:	112.0	Comp. height:	58.2		-4.9		-21.0	Alfin and with oil gallery skirt MOS2 treated	<table border="1"> <tr> <td colspan="2">Rings</td> </tr> <tr> <td>Top:</td> <td>3.0</td> </tr> <tr> <td>2nd:</td> <td>2.0</td> </tr> <tr> <td>oil:</td> <td>3.0</td> </tr> </table>	Rings		Top:	3.0	2nd:	2.0	oil:	3.0	<table border="1"> <tr> <td>Ø:</td> <td>36.0</td> </tr> <tr> <td>Length:</td> <td>79.0</td> </tr> </table>	Ø:	36.0	Length:	79.0
				Liner/ Sleeve																																							
Length:	190.0																																										
Outside Ø:	118.0																																										
Flange Ø:	123.7																																										
Flange depth:	6.0																																										
	Piston																																										
Length:	112.0																																										
Comp. height:	58.2																																										
	-4.9																																										
	-21.0																																										
Rings																																											
Top:	3.0																																										
2nd:	2.0																																										
oil:	3.0																																										
Ø:	36.0																																										
Length:	79.0																																										
4,777 cc 4 cyl 115.0 mm Bore Ø																																											
NM-Motorservice Article no./ Artikelnummer/ Modelo número/ статья номер	NM-Motorservice Article no.:	Reference no.:		Reference no.:	Reference no.:	Reference no.:																																					
				8-97331-643-0	8-97331-641-0	1-12251-036-0																																					
		NM-Motorservice Article no.:																																									
		LB 17200 AF (phosphated) LB 17200 AS LB 17200 - 1 BF+BS (Oversized OD + 0.25) LB 17200 - 2 CF+CS (Oversized OD + 0.50)	NM-Motorservice Article no.:	NM-Motorservice Article no.:	NM-Motorservice Article no.:	NM-Motorservice Article no.:																																					
	LBS 17200 FB LBS 17200 SB		KBS 17200 B	KB 17200 B	KR 17200	PB 17200																																					

ENGINE TYPE Motortyp/ tipo de motor/ тип двигателя	LINER KIT Liner Kit/ camisas de los cilindros/ Лайнер комплект	CYL. LINER Zylinderlaufbuchse/ camisas de los cilindros/ втулка цилиндра		PISTON + RINGS Kolben + Ringe/ Pistón + Anillos/ поршень и кольца		PISTON SET Kolben Set/ Pistón Set/ поршневой	RINGS SET Ring Set/ Anillos Set/ кольца		PIN Pin/ Perno/ Пин	
4HK1-TC 5,193 cc 4 cyl 115.0 mm Bore Ø	OD is graded as A and B	Length: 210.0 Outside Ø: 118.0 Flange Ø: 123.7 Flange depth: 6.0	Liner/ Sleeve	Piston		Alfin and with oil gallery	Rings		Ø : Length: 40.0 87.0	
				Length: 119.9 Comp. height: 66.1 -7.2 -18.8	Top: 2.95 2nd: 2.0 3rd: 2.5 oil: 3.0					
	Reference no.:	Reference no.:		Reference no.:		Reference no.:		Reference no.:		
		8-98014-046-0 8-98014-047-0		8-97602-957-1		8-98017-166-0		8-94391-794-0		
NM-Motorservice Article no./ Artikelnummer/ Modelo número/ статья номер	NM-Motorservice Article no.:	NM-Motorservice Article no.:	NM-Motorservice Article no.:	NM-Motorservice Article no.:	NM-Motorservice Article no.:	NM-Motorservice Article no.:	NM-Motorservice Article no.:	NM-Motorservice Article no.:	NM-Motorservice Article no.:	NM-Motorservice Article no.:
	LBS 17250 FB LBS 17250 SB	LB 17250 F (phosphated) LB 17250 S		KBS 17250 B		KB 17250 B		KR 17250		PB 17250

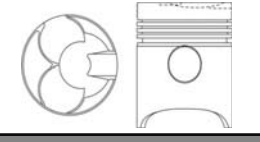

ENGINE TYPE Motortyp/ tipo de motor/ тип двигателя	LINER KIT Liner Kit/ camisas de los cilindros/ Лайнер комплект	CYL. LINER Zylinderlaufbuchse/ camisas de los cilindros/ втулка цилиндра		PISTON + RINGS Kolben + Ringe/ Pistón + Anillos/ поршень и кольца		PISTON SET Kolben Set/ Pistón Set/ поршневой	RINGS SET Ring Set/ Anillos Set/ кольца		PIN Pin/ Perno/ Пин		
6DE1 (L/R) 2,958 cc 6 cyl 87.5 mm Bore Ø		Length: 72.4 Outside Ø: 44.1 Flange Ø: -5.0 Flange depth: -15.2	Flanged	No flange	Piston		Alfin and with oil gallery skirt MOS2 treated	Rings		Ø : Length: 28.5 70.0	
					Length: 72.4 Comp. height: 44.1 -5.0 -15.2	Top: 2.5 2nd: 1.5 3rd: 3.0 oil: 3.0					
	Reference no.:	Reference no.:		Reference no.:		Reference no.:		Reference no.:			
				(L/R)		8-97257-335-1					
NM-Motorservice Article no./ Artikelnummer/ Modelo número/ статья номер	NM-Motorservice Article no.:	NM-Motorservice Article no.:	NM-Motorservice Article no.:	NM-Motorservice Article no.:	NM-Motorservice Article no.:	NM-Motorservice Article no.:	NM-Motorservice Article no.:	NM-Motorservice Article no.:	NM-Motorservice Article no.:	NM-Motorservice Article no.:	
	LBS 17300 PB LBS 17300 SB	LB 17300 P LB 17300 S		KBS 17300 B		KB 17300 B		KR 17300		PB 17300	



ENGINE TYPE Motortyp/ tipo de motor/ тип двигателя	LINER KIT Liner Kit/ camisas de los cilindros/ Лайнер комплект	CYL. LINER Zylinderlaufbuchse/ camisas de los cilindros/ втулка цилиндра		PISTON + RINGS Kolben + Ringe/ Pistón + Anillos/ поршень и кольца		PISTON SET Kolben Set/ Pistón Set/ поршневой	RINGS SET Ring Set/ Anillos Set/ кольца		PIN Pin/ Perno/ Пин	
DA120 4 Rings 6,126 cc 6 cyl 100.0 mm Bore Ø		Length: 220.0 Outside Ø: 113.0 Flange Ø: 119.0 Flange depth: 8.0	Liner/ Sleeve	Piston			Rings		Ø : Length: 34.0 83.5	
				Length: 125.0 Comp. height: 62.0 5.4 -6.0	Top: 2.5 2nd: 2.5 3rd: 2.5 oil: 5.0					
	Reference no.:	Reference no.:		Reference no.:		Reference no.:		Reference no.:		
		9-11261-276-0 9-11261-287-0 9-11261-287-1		1-12111-126-0 1-12111-126-0 9-12111-376-0 9-12111-901-0		1-12121-001-0 1-12181-005-0 1-12181-036-0 1-12181-087-0 1-12181-109-0 1-12181-128-0		9-12251-083-0		
NM-Motorservice Article no./ Artikelnummer/ Modelo número/ статья номер	NM-Motorservice Article no.:	NM-Motorservice Article no.:	NM-Motorservice Article no.:	NM-Motorservice Article no.:	NM-Motorservice Article no.:	NM-Motorservice Article no.:	NM-Motorservice Article no.:	NM-Motorservice Article no.:	NM-Motorservice Article no.:	NM-Motorservice Article no.:
	LBS 17350 F	LB 17350 F		KBS 17350		KB 17350		KR 17350		PB 17350

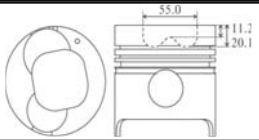

ENGINE TYPE Motortyp/ tipo de motor/ тип двигателя	LINER KIT Liner Kit/ camisas de los cilindros/ Лайнер комплект	CYL. LINER Zylinderlaufbuchse/ camisas de los cilindros/ втулка цилиндра		Piston	Piston	Piston	Piston	Piston	Piston	Piston			
DA640 4 Rings		Length: 228.0 Outside Ø: 113.0 Flange Ø: 119.0 Flange depth: 8.0	Liner/ Sleeve	Piston	Length: 125.0 Comp. height: 68.0 -2.7 -6.3	Rings	Top: 2.5 2nd: 2.5 3rd: 2.5 oil: 5.0	Ø: 36.0 Length: 86.5	Reference no.:	Reference no.:	Reference no.:	Reference no.:	Reference no.:
6,373 cc 6 cyl 102.0 mm Bore Ø													
NM-Motorservice Article no./ Artikelnummer/ Modelo número/ статья номер	NM-Motorservice Article no.:	NM-Motorservice Article no.:	NM-Motorservice Article no.:	NM-Motorservice Article no.:	NM-Motorservice Article no.:	NM-Motorservice Article no.:	NM-Motorservice Article no.:	NM-Motorservice Article no.:	NM-Motorservice Article no.:	NM-Motorservice Article no.:	NM-Motorservice Article no.:	NM-Motorservice Article no.:	NM-Motorservice Article no.:
	LBS 17400 F	LB 17400 F	KBS 17400	KB 17400	KR 17400	PB 17400							

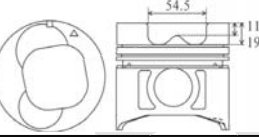

ENGINE TYPE Motortyp/ tipo de motor/ тип двигателя	LINER KIT Liner Kit/ camisas de los cilindros/ Лайнер комплект	CYL. LINER Zylinderlaufbuchse/ camisas de los cilindros/ втулка цилиндра		Piston	Piston	Piston	Piston	Piston	Piston	Piston			
6BB1		Length: 204.0 Outside Ø: 105.0 Flange Ø: 112.0 Flange depth: 1.4	chrome	cast iron	Piston	Length: 112.4 Comp. height: 63.1 9.8 -19.0	Rings	Top: 3.0 2nd: 2.5 oil: 5.0	Ø: 35.0 Length: 87.8	Reference no.:	Reference no.:	Reference no.:	Reference no.:
5,393 cc 6 cyl 102.0 mm Bore Ø													
NM-Motorservice Article no./ Artikelnummer/ Modelo número/ статья номер	NM-Motorservice Article no.:	LB 17450 C (chromed) LB 17450 F (cast iron) LB 17450 S (cast iron)	NM-Motorservice Article no.:	NM-Motorservice Article no.:	NM-Motorservice Article no.:	NM-Motorservice Article no.:	NM-Motorservice Article no.:	NM-Motorservice Article no.:	NM-Motorservice Article no.:	NM-Motorservice Article no.:	NM-Motorservice Article no.:	NM-Motorservice Article no.:	NM-Motorservice Article no.:
	LBS 17450 C LBS 17450 F LBS 17450 S	KBS 17450	KB 17450	KR 17450	PB 17450								

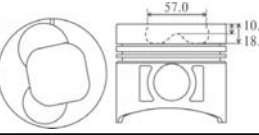

ENGINE TYPE Motortyp/ tipo de motor/ тип двигателя	LINER KIT Liner Kit/ camisas de los cilindros/ Лайнер комплект	CYL. LINER Zylinderlaufbuchse/ camisas de los cilindros/ втулка цилиндра		Piston	Piston	Piston	Piston	Piston	Piston	Piston			
6BD1		Length: 204.0 Outside Ø: 105.0 Flange Ø: 112.0 Flange depth: 1.4	chrome	cast iron	Piston	Length: 104.2 Comp. height: 59.0 -11.1 20.0	Rings	Top: 3.0 2nd: 2.5 oil: 5.0	Ø: 35.0 Length: 87.5	Reference no.:	Reference no.:	Reference no.:	Reference no.:
5,785 cc 6 cyl 102.0 mm Bore Ø													
NM-Motorservice Article no./ Artikelnummer/ Modelo número/ статья номер	NM-Motorservice Article no.:	LB 17500 C (chromed) LB 17500 F (cast iron) LB 17500 S (cast iron)	NM-Motorservice Article no.:	NM-Motorservice Article no.:	NM-Motorservice Article no.:	NM-Motorservice Article no.:	NM-Motorservice Article no.:	NM-Motorservice Article no.:	NM-Motorservice Article no.:	NM-Motorservice Article no.:	NM-Motorservice Article no.:	NM-Motorservice Article no.:	NM-Motorservice Article no.:
	LBS 17500 C LBS 17500 F LBS 17500 S	KBS 17500	KB 17500	KR 17500	PB 17500								

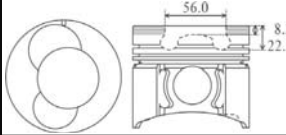

ENGINE TYPE Motortyp/ tipo de motor/ тип двигателя	LINER KIT Liner Kit/ camisas de los cilindros/ Лайнер комплект	CYL. LINER Zylinderlaufbuchse/ camisas de los cilindros/ втулка цилиндра	PISTON + RINGS Kolben + Ringe/ Pistón + Anillos/ поршень и кольца	PISTON SET Kolben Set/ Pistón Set/ поршневой	RINGS SET Ring Set/ Anillos Set/ кольца	PIN Pin/ Perno/ Пин
6BD1T		Liner/ Sleeve	Piston		Rings	
5,785 cc 6 cyl 102.0 mm Bore Ø						
		Reference no.:		Reference no.:	Reference no.:	Reference no.:
		1-11261-118-0 5-11261-004-0 5-11261-118-0		1-12111-240-1 1-12111-303-0 1-12111-303-1 5-12111-240-1 5-12111-303-1	5-12121-005-0 5-12181-023-2	1-12251-027-0 5-12251-006-0
NM-Motorservice Article no./ Artikelnummer/ Modelo número/ статья номер	NM-Motorservice Article no.:	NM-Motorservice Article no.:	NM-Motorservice Article no.:	NM-Motorservice Article no.:	NM-Motorservice Article no.:	NM-Motorservice Article no.:
	LBS 17550 CA	LB 17550 C	KBS 17550 A	KB 17550 A	KR 17550	PB 17550

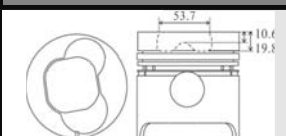

ENGINE TYPE Motortyp/ tipo de motor/ тип двигателя	LINER KIT Liner Kit/ camisas de los cilindros/ Лайнер комплект	CYL. LINER Zylinderlaufbuchse/ camisas de los cilindros/ втулка цилиндра	PISTON + RINGS Kolben + Ringe/ Pistón + Anillos/ поршень и кольца	PISTON SET Kolben Set/ Pistón Set/ поршневой	RINGS SET Ring Set/ Anillos Set/ кольца	PIN Pin/ Perno/ Пин
6BD1T		Liner/ Sleeve	Piston		Rings	
5,785 cc 6 cyl 102.0 mm Bore Ø						
		Reference no.:		Reference no.:	Reference no.:	Reference no.:
		1-11261-118-0 5-11261-004-0 5-11261-118-0		1-12111-325-1 1-12111-428-0 1-12111-428-1	5-12121-005-0 5-12181-023-2	1-12251-027-0 5-12251-006-0
NM-Motorservice Article no./ Artikelnummer/ Modelo número/ статья номер	NM-Motorservice Article no.:	NM-Motorservice Article no.:	NM-Motorservice Article no.:	NM-Motorservice Article no.:	NM-Motorservice Article no.:	NM-Motorservice Article no.:
	LBS 17600 CA	LB 17600 C	KBS 17600 A	KB 17600 A	KR 17600	PB 17600



ENGINE TYPE Motortyp/ tipo de motor/ тип двигателя	LINER KIT Liner Kit/ camisas de los cilindros/ Лайнер комплект	CYL. LINER Zylinderlaufbuchse/ camisas de los cilindros/ втулка цилиндра	PISTON + RINGS Kolben + Ringe/ Pistón + Anillos/ поршень и кольца	PISTON SET Kolben Set/ Pistón Set/ поршневой	RINGS SET Ring Set/ Anillos Set/ кольца	PIN Pin/ Perno/ Пин
6BG1		Liner/ Sleeve	Piston		Rings	
6,494 cc 6 cyl 105.0 mm Bore Ø						
		Reference no.:		Reference no.:	Reference no.:	Reference no.:
		1-11261-119-0		1-12111-323-2 1-12111-377-4	1-12121-065-0	1-12251-027-0 5-12251-006-0
NM-Motorservice Article no./ Artikelnummer/ Modelo número/ статья номер	NM-Motorservice Article no.:	NM-Motorservice Article no.:	NM-Motorservice Article no.:	NM-Motorservice Article no.:	NM-Motorservice Article no.:	NM-Motorservice Article no.:
	LBS 17650 CA	LB 17650 C	KBS 17650 A	KB 17650 A	KR 17650	PB 17650

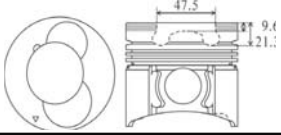

ENGINE TYPE Motortyp/ tipo de motor/ тип двигателя	LINER KIT Liner Kit/ camisas de los cilindros/ Лайнер комплект	CYL. LINER Zylinderlaufbuchse/ camisas de los cilindros/ втулка цилиндра	PISTON + RINGS Kolben + Ringe/ Pistón + Anillos/ поршень и кольца	PISTON SET Kolben Set/ Pistón Set/ поршневой	RINGS SET Ring Set/ Anillos Set/ кольца	PIN Pin/ Perno/ Пин
6BG1T		Liner/ Sleeve	Piston	Alfin and with oil gallery	Rings	
6,494 cc 6 cyl 105.0 mm Bore Ø		Length: 203.0 Outside Ø: 107.0 Flange Ø: 113.0 Flange depth: 1.4	Length: 94.5 Comp. height: 55.2 -8.3 -22.1		Top: 3.5 2nd: 2.5 oil: 4.0	Ø: 35.0 Length: 87.5
		Reference no.:		Reference no.:	Reference no.:	Reference no.:
		1-11261-119-0		1-12111-626-0	1-12121-115-0	1-12251-027-0 5-12251-006-0
NM-Motorservice Article no./ Artikelnummer/ Modelo número/ статья номер	NM-Motorservice Article no.:	NM-Motorservice Article no.:	NM-Motorservice Article no.:	NM-Motorservice Article no.:	NM-Motorservice Article no.:	NM-Motorservice Article no.:
	LBS 17700 CB	LB 17700 C	KBS 17700 B	KB 17700 B	KR 17700	PB 17700

ENGINE TYPE Motortyp/ tipo de motor/ тип двигателя	LINER KIT Liner Kit/ camisas de los cilindros/ Лайнер комплект	CYL. LINER Zylinderlaufbuchse/ camisas de los cilindros/ втулка цилиндра	PISTON + RINGS Kolben + Ringe/ Pistón + Anillos/ поршень и кольца	PISTON SET Kolben Set/ Pistón Set/ поршневой	RINGS SET Ring Set/ Anillos Set/ кольца	PIN Pin/ Perno/ Пин
6BF1		Liner/ Sleeve	Piston		Rings	
6,130 cc 6 cyl 105.0 mm Bore Ø		Length: 203.0 Outside Ø: 107.0 Flange Ø: 113.0 Flange depth: 1.4	Length: 110.0 Comp. height: 58.7 -10.6 -19.8		Top: 3.0 2nd: 2.5 oil: 5.0	Ø: 35.0 Length: 87.5
		Reference no.:		Reference no.:	Reference no.:	Reference no.:
		1-11261-119-0		1-12111-345-0	1-12121-052-0 5-12121-006-0	1-12251-027-0 5-12251-006-0
NM-Motorservice Article no./ Artikelnummer/ Modelo número/ статья номер	NM-Motorservice Article no.:	NM-Motorservice Article no.:	NM-Motorservice Article no.:	NM-Motorservice Article no.:	NM-Motorservice Article no.:	NM-Motorservice Article no.:
	LBS 17750 CA	LB 17750 C	KBS 17750 A	KB 17750 A	KR 17750	PB 17750

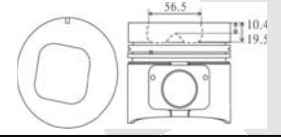
ENGINE TYPE Motortyp/ tipo de motor/ тип двигателя	LINER KIT Liner Kit/ camisas de los cilindros/ Лайнер комплект	CYL. LINER Zylinderlaufbuchse/ camisas de los cilindros/ втулка цилиндра	PISTON + RINGS Kolben + Ringe/ Pistón + Anillos/ поршень и кольца	PISTON SET Kolben Set/ Pistón Set/ поршневой	RINGS SET Ring Set/ Anillos Set/ кольца	PIN Pin/ Perno/ Пин
6BG1T		Liner/ Sleeve	Piston		Rings	
6,494 cc 6 cyl 105.0 mm Bore Ø		Length: 203.0 Outside Ø: 107.0 Flange Ø: 113.0 Flange depth: 1.4	Length: 94.6 Comp. height: 55.4 -10.4 -18.6		Top: 3.0 2nd: 2.5 oil: 4.0	Ø: 35.0 Length: 87.5
		Reference no.:		Reference no.:	Reference no.:	Reference no.:
NM-Motorservice Article no./ Artikelnummer/ Modelo número/ статья номер	NM-Motorservice Article no.:	NM-Motorservice Article no.:	NM-Motorservice Article no.:	NM-Motorservice Article no.:	NM-Motorservice Article no.:	NM-Motorservice Article no.:
	LBS 17800 CA	LB 17800 C	KBS 17800 A	KB 17800 A	KR 17800	PB 17800

ENGINE TYPE Motortyp/ tipo de motor/ тип двигателя	LINER KIT Liner Kit/ camisas de los cilindros/ Лайнер комплект	CYL. LINER Zylinderlaufbuchse/ camisas de los cilindros/ втулка цилиндра	PISTON + RINGS Kolben + Ringe/ Pistón + Anillos/ поршень и кольца	PISTON SET Kolben Set/ Pistón Set/ поршневой	RINGS SET Ring Set/ Anillos Set/ кольца	PIN Pin/ Perno/ Пин
6BG1 6,494 cc 6 cyl 105.0 mm Bore Ø		Liner/ Sleeve	Piston	Alfin and with oil gallery	Rings	Ø : 35.0 Length: 87.5
		Length: 203.0 Outside Ø: 107.0 Flange Ø: 113.0 Flange depth: 1.4				
		Reference no.:		Reference no.:	Reference no.:	Reference no.:
		1-11261-119-0				
NM-Motorservice Article no./ Artikelnummer/ Modelo número/ статья номер	NM-Motorservice Article no.:	NM-Motorservice Article no.:	NM-Motorservice Article no.:	NM-Motorservice Article no.:	NM-Motorservice Article no.:	NM-Motorservice Article no.:
	LBS 17850 CB	LB 17850 C	KBS 17850 B	KB 17850 B	KR 17850	PB 17850

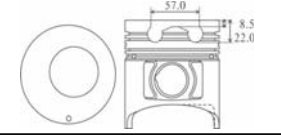

ENGINE TYPE Motortyp/ tipo de motor/ тип двигателя	LINER KIT Liner Kit/ camisas de los cilindros/ Лайнер комплект	CYL. LINER Zylinderlaufbuchse/ camisas de los cilindros/ втулка цилиндра	PISTON + RINGS Kolben + Ringe/ Pistón + Anillos/ поршень и кольца	PISTON SET Kolben Set/ Pistón Set/ поршневой	RINGS SET Ring Set/ Anillos Set/ кольца	PIN Pin/ Perno/ Пин
6HE1 7,127 cc 6 cyl 110.0 mm Bore Ø		Liner/ Sleeve	Piston		Rings	Ø : 36.0 Length: 79.0
		Length: 210.0 Outside Ø: 113.0 Flange Ø: 120.0 Flange depth: 6.0				
		Reference no.:		Reference no.:	Reference no.:	Reference no.:
		8-94396-332-0				
NM-Motorservice Article no./ Artikelnummer/ Modelo número/ статья номер	NM-Motorservice Article no.:	LB 17900 F (phosphated) LB 17900 S	NM-Motorservice Article no.:	NM-Motorservice Article no.:	NM-Motorservice Article no.:	NM-Motorservice Article no.:
	LBS 17900 FA LBS 17900 SA	LB 17900 - 1 F+S (Oversized OD + 0.25) LB 17900 - 2 F+S (Oversized OD + 0.50)	KBS 17900 A	KB 17900 A	KR 17900	PB 17900



ENGINE TYPE Motortyp/ tipo de motor/ тип двигателя	LINER KIT Liner Kit/ camisas de los cilindros/ Лайнер комплект	CYL. LINER Zylinderlaufbuchse/ camisas de los cilindros/ втулка цилиндра	PISTON + RINGS Kolben + Ringe/ Pistón + Anillos/ поршень и кольца	PISTON SET Kolben Set/ Pistón Set/ поршневой	RINGS SET Ring Set/ Anillos Set/ кольца	PIN Pin/ Perno/ Пин
6HE1T 7,127 cc 6 cyl 110.0 mm Bore Ø	LBS 17950 - 1 FB LBS 17950 - 1 SB (Liner OD + 0.25) LBS 17950 - 2 FB LBS 17950 - 2 SB (Liner OD + 0.50)	Liner/ Sleeve	Piston	Alfin and with oil gallery	Rings	Ø : 40.0 Length: 87.0
		Length: 210.0 Outside Ø: 113.0 Flange Ø: 119.7 Flange depth: 5.6 +0.4				
		Reference no.:		Reference no.:	Reference no.:	Reference no.:
		8-94391-600-0 8-94391-601-0				
NM-Motorservice Article no./ Artikelnummer/ Modelo número/ статья номер	NM-Motorservice Article no.:	LB 17950 F (phosphated) LB 17950 S	NM-Motorservice Article no.:	NM-Motorservice Article no.:	NM-Motorservice Article no.:	NM-Motorservice Article no.:
	LBS 17950 FB LBS 17950 SB	LB 17950 - 1 F+S (Oversized OD + 0.25) LB 17950 - 2 F+S (Oversized OD + 0.50)	KBS 17950 B	KB 17950 B	KR 17950	PB 17950

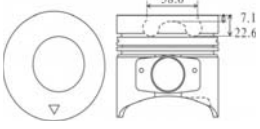

ENGINE TYPE Motortyp/ tipo de motor/ тип двигателя	LINER KIT Liner Kit/ camisas de los cilindros/ Лайнер комплект	CYL. LINER Zylinderlaufbuchse/ camisas de los cilindros/ втулка цилиндра	PISTON + RINGS Kolben + Ringe/ Pistón + Anillos/ поршень и кольца	PISTON SET Kolben Set/ Pistón Set/ поршневой	RINGS SET Ring Set/ Anillos Set/ кольца	PIN Pin/ Perno/ Пин																																							
6HE1T New 7,127 cc 6 cyl 110.0 mm Bore Ø	LBS 24350-1 FB LBS 24350-1 SB (Liner OD + 0.25) LBS 24350-2 FB LBS 24350-2 SB (Liner OD + 0.50)	<table border="1"> <tr> <td></td> <td>Liner/ Sleeve</td> <td></td> </tr> <tr> <td>Length:</td> <td>210.0</td> <td></td> </tr> <tr> <td>Outside Ø:</td> <td>113.0</td> <td></td> </tr> <tr> <td>Flange Ø:</td> <td>119.7</td> <td></td> </tr> <tr> <td>Flange depth:</td> <td>5.6 +0.4</td> <td></td> </tr> </table>		Liner/ Sleeve		Length:	210.0		Outside Ø:	113.0		Flange Ø:	119.7		Flange depth:	5.6 +0.4		<table border="1"> <tr> <td></td> <td>Piston</td> <td></td> </tr> <tr> <td>Length:</td> <td>110.0</td> <td></td> </tr> <tr> <td>Comp. height:</td> <td>66.2 14.1 -22.6</td> <td></td> </tr> </table>		Piston		Length:	110.0		Comp. height:	66.2 14.1 -22.6		Alfin and with oil gallery skirt MOS2 treated	<table border="1"> <tr> <td></td> <td>Rings</td> <td></td> </tr> <tr> <td>Top:</td> <td>3.0</td> <td>Ø : 40.0</td> </tr> <tr> <td>2nd:</td> <td>2.0</td> <td>Length: 57.0</td> </tr> <tr> <td>3rd:</td> <td>1.2</td> <td></td> </tr> <tr> <td>oil:</td> <td>3.0</td> <td></td> </tr> </table>		Rings		Top:	3.0	Ø : 40.0	2nd:	2.0	Length: 57.0	3rd:	1.2		oil:	3.0		
			Liner/ Sleeve																																										
Length:	210.0																																												
Outside Ø:	113.0																																												
Flange Ø:	119.7																																												
Flange depth:	5.6 +0.4																																												
	Piston																																												
Length:	110.0																																												
Comp. height:	66.2 14.1 -22.6																																												
	Rings																																												
Top:	3.0	Ø : 40.0																																											
2nd:	2.0	Length: 57.0																																											
3rd:	1.2																																												
oil:	3.0																																												
<table border="1"> <tr> <td>Reference no.:</td> <td></td> <td></td> </tr> <tr> <td>8-94391-600-0</td> <td></td> <td></td> </tr> <tr> <td>8-94391-601-0</td> <td></td> <td></td> </tr> <tr> <td>NM-Motorservice Article no.:</td> <td></td> <td></td> </tr> </table>	Reference no.:			8-94391-600-0			8-94391-601-0			NM-Motorservice Article no.:			<table border="1"> <tr> <td>Reference no.:</td> <td></td> <td></td> </tr> <tr> <td>8-94391-696-0</td> <td></td> <td></td> </tr> <tr> <td>NM-Motorservice Article no.:</td> <td></td> <td></td> </tr> </table>	Reference no.:			8-94391-696-0			NM-Motorservice Article no.:			<table border="1"> <tr> <td>Reference no.:</td> <td></td> <td></td> </tr> <tr> <td>8-97166-992-0</td> <td></td> <td></td> </tr> <tr> <td>NM-Motorservice Article no.:</td> <td></td> <td></td> </tr> </table>	Reference no.:			8-97166-992-0			NM-Motorservice Article no.:			<table border="1"> <tr> <td>Reference no.:</td> <td></td> <td></td> </tr> <tr> <td>8-94394-613-0</td> <td></td> <td></td> </tr> <tr> <td>NM-Motorservice Article no.:</td> <td></td> <td></td> </tr> </table>	Reference no.:			8-94394-613-0			NM-Motorservice Article no.:					
Reference no.:																																													
8-94391-600-0																																													
8-94391-601-0																																													
NM-Motorservice Article no.:																																													
Reference no.:																																													
8-94391-696-0																																													
NM-Motorservice Article no.:																																													
Reference no.:																																													
8-97166-992-0																																													
NM-Motorservice Article no.:																																													
Reference no.:																																													
8-94394-613-0																																													
NM-Motorservice Article no.:																																													
NM-Motorservice Article no./ Artikelnummer/ Modelo número/ статья номер	NM-Motorservice Article no.:	LB 24350 F (phosphated) LB 24350 S LB 24350 - 1 F+S (Oversized OD + 0.25) LB 24350 - 2 F+S (Oversized OD + 0.50)	NM-Motorservice Article no.:	NM-Motorservice Article no.:	NM-Motorservice Article no.:	NM-Motorservice Article no.:																																							
	LBS 24350 FB LBS 24350 SB		KBS 24350 B	KB 24350 B	KR 24350	PB 24350																																							

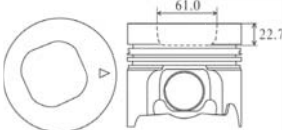

ENGINE TYPE Motortyp/ tipo de motor/ тип двигателя	LINER KIT Liner Kit/ camisas de los cilindros/ Лайнер комплект	CYL. LINER Zylinderlaufbuchse/ camisas de los cilindros/ втулка цилиндра	PISTON + RINGS Kolben + Ringe/ Pistón + Anillos/ поршень и кольца	PISTON SET Kolben Set/ Pistón Set/ поршневой	RINGS SET Ring Set/ Anillos Set/ кольца	PIN Pin/ Perno/ Пин																																													
6HE1-TC 7,127 cc 6 cyl 110.0 mm Bore Ø	LBS 18050-1 CFB LBS 18050-1 CSB (Liner OD + 0.25) LBS 18050-1 DFB LBS 18050-1 DSB (Liner OD + 0.50)	<table border="1"> <tr> <td></td> <td>Liner/ Sleeve</td> <td></td> </tr> <tr> <td>Length:</td> <td>210.0</td> <td></td> </tr> <tr> <td>Outside Ø:</td> <td>113.0</td> <td></td> </tr> <tr> <td>Flange Ø:</td> <td>119.7</td> <td></td> </tr> <tr> <td>Flange depth:</td> <td>5.6 0.4</td> <td></td> </tr> </table>		Liner/ Sleeve		Length:	210.0		Outside Ø:	113.0		Flange Ø:	119.7		Flange depth:	5.6 0.4		<table border="1"> <tr> <td></td> <td>Piston</td> <td></td> </tr> <tr> <td>Length:</td> <td>119.9</td> <td></td> </tr> <tr> <td>Comp. height:</td> <td>66.1 -6.1 -23.1</td> <td></td> </tr> </table>		Piston		Length:	119.9		Comp. height:	66.1 -6.1 -23.1		Alfin and with oil gallery	<table border="1"> <tr> <td></td> <td>Rings</td> <td></td> </tr> <tr> <td>Top:</td> <td>3.9</td> <td>Ø : 40.0</td> </tr> <tr> <td>2nd:</td> <td>3.0</td> <td>Length: 87.0</td> </tr> <tr> <td>3rd:</td> <td>2.5</td> <td></td> </tr> <tr> <td>oil:</td> <td>3.0</td> <td></td> </tr> </table>		Rings		Top:	3.9	Ø : 40.0	2nd:	3.0	Length: 87.0	3rd:	2.5		oil:	3.0								
			Liner/ Sleeve																																																
Length:	210.0																																																		
Outside Ø:	113.0																																																		
Flange Ø:	119.7																																																		
Flange depth:	5.6 0.4																																																		
	Piston																																																		
Length:	119.9																																																		
Comp. height:	66.1 -6.1 -23.1																																																		
	Rings																																																		
Top:	3.9	Ø : 40.0																																																	
2nd:	3.0	Length: 87.0																																																	
3rd:	2.5																																																		
oil:	3.0																																																		
<table border="1"> <tr> <td>Reference no.:</td> <td></td> <td></td> </tr> <tr> <td>8-94391-600-0</td> <td></td> <td></td> </tr> <tr> <td>8-94391-601-0</td> <td></td> <td></td> </tr> <tr> <td>NM-Motorservice Article no.:</td> <td></td> <td></td> </tr> </table>	Reference no.:			8-94391-600-0			8-94391-601-0			NM-Motorservice Article no.:			<table border="1"> <tr> <td>Reference no.:</td> <td></td> <td></td> </tr> <tr> <td>8-94391-596-1</td> <td></td> <td></td> </tr> <tr> <td>NM-Motorservice Article no.:</td> <td></td> <td></td> </tr> </table>	Reference no.:			8-94391-596-1			NM-Motorservice Article no.:			<table border="1"> <tr> <td>Reference no.:</td> <td></td> <td></td> </tr> <tr> <td>8-94390-529-1</td> <td></td> <td></td> </tr> <tr> <td>8-94395-061-3</td> <td></td> <td></td> </tr> <tr> <td>8-84395-061-4</td> <td></td> <td></td> </tr> <tr> <td>8-94395-061-5</td> <td></td> <td></td> </tr> <tr> <td>NM-Motorservice Article no.:</td> <td></td> <td></td> </tr> </table>	Reference no.:			8-94390-529-1			8-94395-061-3			8-84395-061-4			8-94395-061-5			NM-Motorservice Article no.:			<table border="1"> <tr> <td>Reference no.:</td> <td></td> <td></td> </tr> <tr> <td>8-94394-613-0</td> <td></td> <td></td> </tr> <tr> <td>NM-Motorservice Article no.:</td> <td></td> <td></td> </tr> </table>	Reference no.:			8-94394-613-0			NM-Motorservice Article no.:		
Reference no.:																																																			
8-94391-600-0																																																			
8-94391-601-0																																																			
NM-Motorservice Article no.:																																																			
Reference no.:																																																			
8-94391-596-1																																																			
NM-Motorservice Article no.:																																																			
Reference no.:																																																			
8-94390-529-1																																																			
8-94395-061-3																																																			
8-84395-061-4																																																			
8-94395-061-5																																																			
NM-Motorservice Article no.:																																																			
Reference no.:																																																			
8-94394-613-0																																																			
NM-Motorservice Article no.:																																																			
NM-Motorservice Article no./ Artikelnummer/ Modelo número/ статья номер	NM-Motorservice Article no.:	LB 18050 F (phosphated) LB 18050 S LB 18050 - 1 F+S (Oversized OD + 0.25) LB 18050 - 2 F+S (Oversized OD + 0.50)	NM-Motorservice Article no.:	NM-Motorservice Article no.:	NM-Motorservice Article no.:	NM-Motorservice Article no.:																																													
	LBS 18050 FB LBS 18050 SB		KBS 18050 B	KB 18050 B	KR 18050	PB 18050																																													

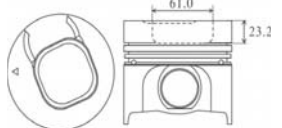

ENGINE TYPE Motortyp/ tipo de motor/ тип двигателя	LINER KIT Liner Kit/ camisas de los cilindros/ Лайнер комплект	CYL. LINER Zylinderlaufbuchse/ camisas de los cilindros/ втулка цилиндра	PISTON + RINGS Kolben + Ringe/ Pistón + Anillos/ поршень и кольца	PISTON SET Kolben Set/ Pistón Set/ поршневой	RINGS SET Ring Set/ Anillos Set/ кольца	PIN Pin/ Perno/ Пин																																													
6HE1T 7,127 cc 6 cyl 110.0 mm Bore Ø	LBS 18100-1 FB LBS 18100-1 SB (Liner OD + 0.25) LBS 18100-2 FB LBS 18100-2 SB (Liner OD + 0.50)	<table border="1"> <tr> <td></td> <td>Liner/ Sleeve</td> <td></td> </tr> <tr> <td>Length:</td> <td>210.0</td> <td></td> </tr> <tr> <td>Outside Ø:</td> <td>113.0</td> <td></td> </tr> <tr> <td>Flange Ø:</td> <td>119.7</td> <td></td> </tr> <tr> <td>Flange depth:</td> <td>5.6 +0.4</td> <td></td> </tr> </table>		Liner/ Sleeve		Length:	210.0		Outside Ø:	113.0		Flange Ø:	119.7		Flange depth:	5.6 +0.4		<table border="1"> <tr> <td></td> <td>Piston</td> <td></td> </tr> <tr> <td>Length:</td> <td>119.9</td> <td></td> </tr> <tr> <td>Comp. height:</td> <td>66.1 -6.1 -22.4</td> <td></td> </tr> </table>		Piston		Length:	119.9		Comp. height:	66.1 -6.1 -22.4		Alfin and with oil gallery	<table border="1"> <tr> <td></td> <td>Rings</td> <td></td> </tr> <tr> <td>Top:</td> <td>3.9</td> <td>Ø : 40.0</td> </tr> <tr> <td>2nd:</td> <td>3.0</td> <td>Length: 87.0</td> </tr> <tr> <td>3rd:</td> <td>2.5</td> <td></td> </tr> <tr> <td>oil:</td> <td>3.0</td> <td></td> </tr> </table>		Rings		Top:	3.9	Ø : 40.0	2nd:	3.0	Length: 87.0	3rd:	2.5		oil:	3.0								
			Liner/ Sleeve																																																
Length:	210.0																																																		
Outside Ø:	113.0																																																		
Flange Ø:	119.7																																																		
Flange depth:	5.6 +0.4																																																		
	Piston																																																		
Length:	119.9																																																		
Comp. height:	66.1 -6.1 -22.4																																																		
	Rings																																																		
Top:	3.9	Ø : 40.0																																																	
2nd:	3.0	Length: 87.0																																																	
3rd:	2.5																																																		
oil:	3.0																																																		
<table border="1"> <tr> <td>Reference no.:</td> <td></td> <td></td> </tr> <tr> <td>8-94391-600-0</td> <td></td> <td></td> </tr> <tr> <td>8-94391-601-0</td> <td></td> <td></td> </tr> <tr> <td>NM-Motorservice Article no.:</td> <td></td> <td></td> </tr> </table>	Reference no.:			8-94391-600-0			8-94391-601-0			NM-Motorservice Article no.:			<table border="1"> <tr> <td>Reference no.:</td> <td></td> <td></td> </tr> <tr> <td>8-94391-605-0</td> <td></td> <td></td> </tr> <tr> <td>NM-Motorservice Article no.:</td> <td></td> <td></td> </tr> </table>	Reference no.:			8-94391-605-0			NM-Motorservice Article no.:			<table border="1"> <tr> <td>Reference no.:</td> <td></td> <td></td> </tr> <tr> <td>8-94390-529-1</td> <td></td> <td></td> </tr> <tr> <td>8-94395-061-3</td> <td></td> <td></td> </tr> <tr> <td>8-84395-061-4</td> <td></td> <td></td> </tr> <tr> <td>8-94395-061-5</td> <td></td> <td></td> </tr> <tr> <td>NM-Motorservice Article no.:</td> <td></td> <td></td> </tr> </table>	Reference no.:			8-94390-529-1			8-94395-061-3			8-84395-061-4			8-94395-061-5			NM-Motorservice Article no.:			<table border="1"> <tr> <td>Reference no.:</td> <td></td> <td></td> </tr> <tr> <td>8-94394-613-0</td> <td></td> <td></td> </tr> <tr> <td>NM-Motorservice Article no.:</td> <td></td> <td></td> </tr> </table>	Reference no.:			8-94394-613-0			NM-Motorservice Article no.:		
Reference no.:																																																			
8-94391-600-0																																																			
8-94391-601-0																																																			
NM-Motorservice Article no.:																																																			
Reference no.:																																																			
8-94391-605-0																																																			
NM-Motorservice Article no.:																																																			
Reference no.:																																																			
8-94390-529-1																																																			
8-94395-061-3																																																			
8-84395-061-4																																																			
8-94395-061-5																																																			
NM-Motorservice Article no.:																																																			
Reference no.:																																																			
8-94394-613-0																																																			
NM-Motorservice Article no.:																																																			
NM-Motorservice Article no./ Artikelnummer/ Modelo número/ статья номер	NM-Motorservice Article no.:	LB 18100 F (phosphated) LB 18100 S LB 18100 - 1 F+S (Oversized OD + 0.25) LB 18100 - 2 F+S (Oversized OD + 0.50)	NM-Motorservice Article no.:	NM-Motorservice Article no.:	NM-Motorservice Article no.:	NM-Motorservice Article no.:																																													
	LBS 18100 FB LBS 18100 SB		KBS 18100 B	KB 18100 B	KR 18100	PB 18100																																													

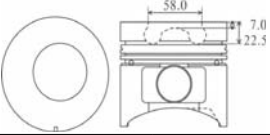

ENGINE TYPE Motortyp/ tipo de motor/ тип двигателя	LINER KIT Liner Kit/ camisas de los cilindros/ Лайнер комплект	CYL. LINER Zylinderlaufbuchse/ camisas de los cilindros/ втулка цилиндра	PISTON + RINGS Kolben + Ringe/ Pistón + Anillos/ поршень и кольца	PISTON SET Kolben Set/ Pistón Set/ поршневой	RINGS SET Ring Set/ Anillos Set/ кольца	PIN Pin/ Perno/ Пин
6HH1 8,226 cc 6 cyl 115.0 mm Bore Ø		Liner/ Sleeve	Piston		Rings	Ø : 36.0 Length: 79.0
		Length: Outside Ø: Flange Ø: Flange depth:	210.0 118.0 123.7 6.0			
		Reference no.:		Reference no.:	Reference no.:	Reference no.:
		8-94391-602-0 8-94391-603-0 8-94393-273-1		8-94391-950-0	8-94390-799-0 8-94390-799-2	1-12251-036-0
NM-Motorservice Article no./ Artikelnummer/ Modelo número/ статья номер	NM-Motorservice Article no.:	LB 18150 F (phosphated) LB 18150 S	NM-Motorservice Article no.:	NM-Motorservice Article no.:	NM-Motorservice Article no.:	NM-Motorservice Article no.:
	LBS 18150 FA LBS 18150 SA	LB 18150 - 1 F+S (Oversized OD + 0.25) LB 18150 - 2 F+S (Oversized OD + 0.50)	KBS 18150 A	KB 18150 A	KR 18150	PB 18150

ENGINE TYPE Motortyp/ tipo de motor/ тип двигателя	LINER KIT Liner Kit/ camisas de los cilindros/ Лайнер комплект	CYL. LINER Zylinderlaufbuchse/ camisas de los cilindros/ втулка цилиндра	PISTON + RINGS Kolben + Ringe/ Pistón + Anillos/ поршень и кольца	PISTON SET Kolben Set/ Pistón Set/ поршневой	RINGS SET Ring Set/ Anillos Set/ кольца	PIN Pin/ Perno/ Пин
6SA1 8,413 cc 6 cyl 115.0 mm Bore Ø		Liner/ Sleeve	Piston		Rings	Ø : 38.0 Length: 80.0
		Length: Outside Ø: Flange Ø: Flange depth:	216.0 119.0 126.0 6.0			
		Reference no.:		Reference no.:	Reference no.:	Reference no.:
		1-11261-065-3 1-11261-094-1		1-12111-217-1	1-12121-070-0 1-12121-075-0 1-12121-113-0 1-12121-750-0	1-12251-016-0 1-12251-016-2
NM-Motorservice Article no./ Artikelnummer/ Modelo número/ статья номер	NM-Motorservice Article no.:	NM-Motorservice Article no.:	NM-Motorservice Article no.:	NM-Motorservice Article no.:	NM-Motorservice Article no.:	NM-Motorservice Article no.:
	LBS 18200 FA	LB 18200 F (phosphated)	KBS 18200 A	KB 18200 A	KR 18200	PB 18200

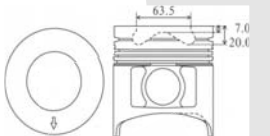
ENGINE TYPE Motortyp/ tipo de motor/ тип двигателя	LINER KIT Liner Kit/ camisas de los cilindros/ Лайнер комплект	CYL. LINER Zylinderlaufbuchse/ camisas de los cilindros/ втулка цилиндра	PISTON + RINGS Kolben + Ringe/ Pistón + Anillos/ поршень и кольца	PISTON SET Kolben Set/ Pistón Set/ поршневой	RINGS SET Ring Set/ Anillos Set/ кольца	PIN Pin/ Perno/ Пин
6SA1T 8,413 cc 6 cyl 115.0 mm Bore Ø		Liner/ Sleeve	Piston	Alfin and with oil gallery	Rings	Ø : 38.0 Length: 80.0
		Length: Outside Ø: Flange Ø: Flange depth:	216.0 119.0 126.0 6.0			
		Reference no.:		Reference no.:	Reference no.:	Reference no.:
		1-11261-065-3 1-11261-094-1		1-12111-459-1	1-12121-070-0 1-12121-075-0 1-12121-113-0 1-12121-750-0	1-12251-016-0 1-12251-016-2
NM-Motorservice Article no./ Artikelnummer/ Modelo número/ статья номер	NM-Motorservice Article no.:	NM-Motorservice Article no.:	NM-Motorservice Article no.:	NM-Motorservice Article no.:	NM-Motorservice Article no.:	NM-Motorservice Article no.:
	LBS 18250 FB	LB 18250 F (phosphated)	KBS 18250 B	KB 18250 B	KR 18250	PB 18250

ENGINE TYPE Motortyp/ tipo de motor/ тип двигателя	LINER KIT Liner Kit/ camisas de los cilindros/ Лайнер комплект	CYL. LINER Zylinderlaufbuchse/ camisas de los cilindros/ втулка цилиндра	PISTON + RINGS Kolben + Ringe/ Pistón + Anillos/ поршень и кольца	PISTON SET Kolben Set/ Pistón Set/ поршневой	RINGS SET Ring Set/ Anillos Set/ кольца	PIN Pin/ Perno/ Пин																															
6HH1 6HH1T 8,226 cc 6 cyl 115.0 mm Bore Ø		<table border="1"> <tr> <td></td> <td>Liner/ Sleeve</td> <td></td> </tr> <tr> <td>Length:</td> <td>210.0</td> <td></td> </tr> <tr> <td>Outside Ø:</td> <td>118.0</td> <td></td> </tr> <tr> <td>Flange Ø:</td> <td>123.7</td> <td></td> </tr> <tr> <td>Flange depth:</td> <td>6.0</td> <td></td> </tr> </table>		Liner/ Sleeve		Length:	210.0		Outside Ø:	118.0		Flange Ø:	123.7		Flange depth:	6.0		<table border="1"> <tr> <td></td> <td>Piston</td> </tr> <tr> <td>Length:</td> <td>106.3</td> </tr> <tr> <td>Comp. height:</td> <td>62.6 -7.0 -22.5</td> </tr> </table>		Piston	Length:	106.3	Comp. height:	62.6 -7.0 -22.5	Alfin and with oil gallery	<table border="1"> <tr> <td></td> <td>Rings</td> </tr> <tr> <td>Top:</td> <td>3.5</td> </tr> <tr> <td>2nd: oil:</td> <td>2.5 4.0</td> </tr> <tr> <td>Ø:</td> <td>36.0</td> </tr> <tr> <td>Length:</td> <td>79.0</td> </tr> </table>		Rings	Top:	3.5	2nd: oil:	2.5 4.0	Ø:	36.0	Length:	79.0	
				Liner/ Sleeve																																	
Length:	210.0																																				
Outside Ø:	118.0																																				
Flange Ø:	123.7																																				
Flange depth:	6.0																																				
	Piston																																				
Length:	106.3																																				
Comp. height:	62.6 -7.0 -22.5																																				
	Rings																																				
Top:	3.5																																				
2nd: oil:	2.5 4.0																																				
Ø:	36.0																																				
Length:	79.0																																				
	Reference no.:	Reference no.:	Reference no.:																																		
		8-94391-602-0 8-94391-603-0 8-94393-273-1 NM-Motorservice Article no.:		Reference no.:	Reference no.:	Reference no.:																															
NM-Motorservice Article no./ Artikelnummer/ Modelo número/ статья номер	NM-Motorservice Article no.:	LB 18300 F (phosphated) LB 18300 S LB 18300 - 1 F+S (Oversized OD + 0.25) LB 18300 - 2 F+S (Oversized OD + 0.50)	NM-Motorservice Article no.:	NM-Motorservice Article no.:	NM-Motorservice Article no.:	NM-Motorservice Article no.:																															
	LBS 18300 FB LBS 18300 SB		KBS 18300 B	KB 18300 B	KR 18300	PB 18300																															

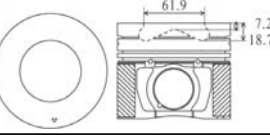
ENGINE TYPE Motortyp/ tipo de motor/ тип двигателя	LINER KIT Liner Kit/ camisas de los cilindros/ Лайнер комплект	CYL. LINER Zylinderlaufbuchse/ camisas de los cilindros/ втулка цилиндра	PISTON + RINGS Kolben + Ringe/ Pistón + Anillos/ поршень и кольца	PISTON SET Kolben Set/ Pistón Set/ поршневой	RINGS SET Ring Set/ Anillos Set/ кольца	PIN Pin/ Perno/ Пин																															
6HK1-TC 7,790 cc 6 cyl 115.0 mm Bore Ø	LBS 18350 -1 FB LBS 18350 -1 SB (Liner OD + 0.25) LBS 18350 -2 FB LBS 18350 -2 SB (Liner OD + 0.50)	<table border="1"> <tr> <td></td> <td>Liner/ Sleeve</td> <td></td> </tr> <tr> <td>Length:</td> <td>210.0</td> <td></td> </tr> <tr> <td>Outside Ø:</td> <td>118.0</td> <td></td> </tr> <tr> <td>Flange Ø:</td> <td>123.7</td> <td></td> </tr> <tr> <td>Flange depth:</td> <td>6.0</td> <td></td> </tr> </table>		Liner/ Sleeve		Length:	210.0		Outside Ø:	118.0		Flange Ø:	123.7		Flange depth:	6.0		<table border="1"> <tr> <td></td> <td>Piston</td> </tr> <tr> <td>Length:</td> <td>119.7</td> </tr> <tr> <td>Comp. height:</td> <td>66.1 -7.0 -20.0</td> </tr> </table>		Piston	Length:	119.7	Comp. height:	66.1 -7.0 -20.0	Alfin and with oil gallery	<table border="1"> <tr> <td></td> <td>Rings</td> </tr> <tr> <td>Top:</td> <td>2.95</td> </tr> <tr> <td>2nd: oil:</td> <td>2.0 2.5 3.0</td> </tr> <tr> <td>Ø:</td> <td>40.0</td> </tr> <tr> <td>Length:</td> <td>87.0</td> </tr> </table>		Rings	Top:	2.95	2nd: oil:	2.0 2.5 3.0	Ø:	40.0	Length:	87.0	
				Liner/ Sleeve																																	
Length:	210.0																																				
Outside Ø:	118.0																																				
Flange Ø:	123.7																																				
Flange depth:	6.0																																				
	Piston																																				
Length:	119.7																																				
Comp. height:	66.1 -7.0 -20.0																																				
	Rings																																				
Top:	2.95																																				
2nd: oil:	2.0 2.5 3.0																																				
Ø:	40.0																																				
Length:	87.0																																				
	Reference no.:	Reference no.:	Reference no.:																																		
		8-94391-602-0 8-94391-603-0 8-94393-273-1 NM-Motorservice Article no.:		Reference no.:	Reference no.:	Reference no.:																															
NM-Motorservice Article no./ Artikelnummer/ Modelo número/ статья номер	NM-Motorservice Article no.:	LB 18350 F (phosphated) LB 18350 S LB 18350 - 1 F+S (Oversized OD + 0.25) LB 18350 - 2 F+S (Oversized OD + 0.50)	NM-Motorservice Article no.:	NM-Motorservice Article no.:	NM-Motorservice Article no.:	NM-Motorservice Article no.:																															
	LBS 18350 FB LBS 18350 SB		KBS 18350 B	KB 18350 B	KR 18350	PB 18350																															

ENGINE TYPE Motortyp/ tipo de motor/ тип двигателя	LINER KIT Liner Kit/ camisas de los cilindros/ Лайнер комплект	CYL. LINER Zylinderlaufbuchse/ camisas de los cilindros/ втулка цилиндра	PISTON + RINGS Kolben + Ringe/ Pistón + Anillos/ поршень и кольца	PISTON SET Kolben Set/ Pistón Set/ поршневой	RINGS SET Ring Set/ Anillos Set/ кольца	PIN Pin/ Perno/ Пин																															
6HK1-TC (NPR NQR) 2006- 7,790 cc 6 cyl 115.0 mm Bore Ø		<table border="1"> <tr> <td></td> <td>Liner/ Sleeve</td> <td></td> </tr> <tr> <td>Length:</td> <td>210.0</td> <td></td> </tr> <tr> <td>Outside Ø:</td> <td>118.0</td> <td></td> </tr> <tr> <td>Flange Ø:</td> <td>123.7</td> <td></td> </tr> <tr> <td>Flange depth:</td> <td>6.0</td> <td></td> </tr> </table>		Liner/ Sleeve		Length:	210.0		Outside Ø:	118.0		Flange Ø:	123.7		Flange depth:	6.0		<table border="1"> <tr> <td></td> <td>Piston</td> </tr> <tr> <td>Length:</td> <td>96.5</td> </tr> <tr> <td>Comp. height:</td> <td>66.1 -7.2 -18.7</td> </tr> </table>		Piston	Length:	96.5	Comp. height:	66.1 -7.2 -18.7	Alfin and with oil gallery skirt MOS2 treated	<table border="1"> <tr> <td></td> <td>Rings</td> </tr> <tr> <td>Top:</td> <td>3.0</td> </tr> <tr> <td>2nd: oil:</td> <td>2.5 4.0</td> </tr> <tr> <td>Ø:</td> <td>40.0</td> </tr> <tr> <td>Length:</td> <td>87.0</td> </tr> </table>		Rings	Top:	3.0	2nd: oil:	2.5 4.0	Ø:	40.0	Length:	87.0	
				Liner/ Sleeve																																	
Length:	210.0																																				
Outside Ø:	118.0																																				
Flange Ø:	123.7																																				
Flange depth:	6.0																																				
	Piston																																				
Length:	96.5																																				
Comp. height:	66.1 -7.2 -18.7																																				
	Rings																																				
Top:	3.0																																				
2nd: oil:	2.5 4.0																																				
Ø:	40.0																																				
Length:	87.0																																				
	Reference no.:	Reference no.:	Reference no.:																																		
		1-87813-119-0 5-87814-990-0 5-87814-991-0	8-94391-602-0 8-94391-603-0 8-94393-273-1	Reference no.:	Reference no.:	Reference no.:																															
NM-Motorservice Article no./ Artikelnummer/ Modelo número/ статья номер	NM-Motorservice Article no.:	NM-Motorservice Article no.:	NM-Motorservice Article no.:	NM-Motorservice Article no.:	NM-Motorservice Article no.:	NM-Motorservice Article no.:																															
	LBS 18400 FB LBS 18400 SB	LB 18400 F (phosphated) LB 18400 S	KBS 18400 B	KB 18400 B	KR 18400	PB 18400																															

ENGINE TYPE Motortyp/ tipo de motor/ тип двигателя	LINER KIT Liner Kit/ camisas de los cilindros/ Лайнер комплект	CYL. LINER Zylinderlaufbuchse/ camisas de los cilindros/ втулка цилиндра	PISTON + RINGS Kolben + Ringe/ Pistón + Anillos/ поршень и кольца	PISTON SET Kolben Set/ Pistón Set/ поршневой	RINGS SET Ring Set/ Anillos Set/ кольца	PIN Pin/ Perno/ Пин																																																			
6HK1-TC 7,166 cc 6 cyl 115.0 mm Bore Ø		<table border="1"> <tr> <td></td> <td>Liner/ Sleeve</td> <td></td> </tr> <tr> <td>Length:</td> <td>210.0</td> <td></td> </tr> <tr> <td>Outside Ø:</td> <td>118.0</td> <td></td> </tr> <tr> <td>Flange Ø:</td> <td>123.7</td> <td></td> </tr> <tr> <td>Flange depth:</td> <td>6.0</td> <td></td> </tr> </table>		Liner/ Sleeve		Length:	210.0		Outside Ø:	118.0		Flange Ø:	123.7		Flange depth:	6.0		<table border="1"> <tr> <td></td> <td>Piston</td> <td></td> </tr> <tr> <td>Length:</td> <td>119.9</td> <td></td> </tr> <tr> <td>Comp. height:</td> <td>66.1</td> <td></td> </tr> <tr> <td></td> <td>-7.2</td> <td></td> </tr> <tr> <td></td> <td>-18.8</td> <td></td> </tr> </table>		Piston		Length:	119.9		Comp. height:	66.1			-7.2			-18.8		Alfin and with oil gallery	<table border="1"> <tr> <td></td> <td>Rings</td> <td></td> </tr> <tr> <td>Top:</td> <td>2.95</td> <td></td> </tr> <tr> <td>2nd:</td> <td>2.0</td> <td></td> </tr> <tr> <td>3rd:</td> <td>2.5</td> <td></td> </tr> <tr> <td>oil:</td> <td>3.0</td> <td></td> </tr> </table>		Rings		Top:	2.95		2nd:	2.0		3rd:	2.5		oil:	3.0		<table border="1"> <tr> <td></td> <td>Ø :</td> <td>40.0</td> </tr> <tr> <td>Length:</td> <td></td> <td>87.0</td> </tr> </table>		Ø :	40.0	Length:		87.0
				Liner/ Sleeve																																																					
Length:	210.0																																																								
Outside Ø:	118.0																																																								
Flange Ø:	123.7																																																								
Flange depth:	6.0																																																								
	Piston																																																								
Length:	119.9																																																								
Comp. height:	66.1																																																								
	-7.2																																																								
	-18.8																																																								
	Rings																																																								
Top:	2.95																																																								
2nd:	2.0																																																								
3rd:	2.5																																																								
oil:	3.0																																																								
	Ø :	40.0																																																							
Length:		87.0																																																							
		Reference no.:		Reference no.:	Reference no.:	Reference no.:																																																			
		8-94391-602-0 8-94391-603-0 8-94393-273-1		8-98023-526-1	8-94391-502-3 8-94391-502-4	8-94394-613-0																																																			
NM-Motorservice Article no./ Artikelnummer/ Modelo número/ статья номер	NM-Motorservice Article no.:	NM-Motorservice Article no.:	NM-Motorservice Article no.:	NM-Motorservice Article no.:	NM-Motorservice Article no.:	NM-Motorservice Article no.:																																																			
	LBS 18450 FB LBS 18450 SB	LB 18450 F (phosphated) LB 18450 S	KBS 18450 B	KB 18450 B	KR 18450	PB 18450																																																			



ENGINE TYPE Motortyp/ tipo de motor/ тип двигателя	LINER KIT Liner Kit/ camisas de los cilindros/ Лайнер комплект	CYL. LINER Zylinderlaufbuchse/ camisas de los cilindros/ втулка цилиндра	PISTON + RINGS Kolben + Ringe/ Pistón + Anillos/ поршень и кольца	PISTON SET Kolben Set/ Pistón Set/ поршневой	RINGS SET Ring Set/ Anillos Set/ кольца	PIN Pin/ Perno/ Пин																																																
6HL1-TC 7,166 cc 6 cyl 115.0 mm Bore Ø		<table border="1"> <tr> <td></td> <td>Liner/ Sleeve</td> <td></td> </tr> <tr> <td>Length:</td> <td>210.0</td> <td></td> </tr> <tr> <td>Outside Ø:</td> <td>118.0</td> <td></td> </tr> <tr> <td>Flange Ø:</td> <td>123.7</td> <td></td> </tr> <tr> <td>Flange depth:</td> <td>6.0</td> <td></td> </tr> </table>		Liner/ Sleeve		Length:	210.0		Outside Ø:	118.0		Flange Ø:	123.7		Flange depth:	6.0		<table border="1"> <tr> <td></td> <td>Piston</td> <td></td> </tr> <tr> <td>Length:</td> <td>119.9</td> <td></td> </tr> <tr> <td>Comp. height:</td> <td>66.1</td> <td></td> </tr> <tr> <td></td> <td>-7.2</td> <td></td> </tr> <tr> <td></td> <td>-19.0</td> <td></td> </tr> </table>		Piston		Length:	119.9		Comp. height:	66.1			-7.2			-19.0		Alfin and with oil gallery	<table border="1"> <tr> <td></td> <td>Rings</td> <td></td> </tr> <tr> <td>Top:</td> <td>3.0</td> <td></td> </tr> <tr> <td>2nd:</td> <td>2.5</td> <td></td> </tr> <tr> <td>oil:</td> <td>3.0</td> <td></td> </tr> </table>		Rings		Top:	3.0		2nd:	2.5		oil:	3.0		<table border="1"> <tr> <td></td> <td>Ø :</td> <td>40.0</td> </tr> <tr> <td>Length:</td> <td></td> <td>87.0</td> </tr> </table>		Ø :	40.0	Length:		87.0
				Liner/ Sleeve																																																		
Length:	210.0																																																					
Outside Ø:	118.0																																																					
Flange Ø:	123.7																																																					
Flange depth:	6.0																																																					
	Piston																																																					
Length:	119.9																																																					
Comp. height:	66.1																																																					
	-7.2																																																					
	-19.0																																																					
	Rings																																																					
Top:	3.0																																																					
2nd:	2.5																																																					
oil:	3.0																																																					
	Ø :	40.0																																																				
Length:		87.0																																																				
		Reference no.:		Reference no.:	Reference no.:	Reference no.:																																																
		8-94391-602-0 8-94391-603-0 8-94393-273-1		8-97602-904-0	8-97601-318-1	8-94394-613-0																																																
NM-Motorservice Article no./ Artikelnummer/ Modelo número/ статья номер	NM-Motorservice Article no.:	NM-Motorservice Article no.:	NM-Motorservice Article no.:	NM-Motorservice Article no.:	NM-Motorservice Article no.:	NM-Motorservice Article no.:																																																
	LBS 44600 FB LBS 44600 SB	LB 44600 F (phosphated) LB 44600 S	KBS 44600 B	KB 44600 B	KR 44600	PB 44600																																																



ENGINE TYPE Motortyp/ tipo de motor/ тип двигателя	LINER KIT Liner Kit/ camisas de los cilindros/ Лайнер комплект	CYL. LINER Zylinderlaufbuchse/ camisas de los cilindros/ втулка цилиндра	PISTON + RINGS Kolben + Ringe/ Pistón + Anillos/ поршень и кольца	PISTON SET Kolben Set/ Pistón Set/ поршневой	RINGS SET Ring Set/ Anillos Set/ кольца	PIN Pin/ Perno/ Пин																																																			
DH100 10,179 cc 6 cyl 120.0 mm Bore Ø		<table border="1"> <tr> <td></td> <td>Liner/ Sleeve</td> <td></td> </tr> <tr> <td>Length:</td> <td>280.0</td> <td></td> </tr> <tr> <td>Outside Ø:</td> <td>135.0</td> <td></td> </tr> <tr> <td>Flange Ø:</td> <td>140.6</td> <td></td> </tr> <tr> <td>Flange depth:</td> <td>11.0</td> <td></td> </tr> </table>		Liner/ Sleeve		Length:	280.0		Outside Ø:	135.0		Flange Ø:	140.6		Flange depth:	11.0		<table border="1"> <tr> <td></td> <td>Piston</td> <td></td> </tr> <tr> <td>Length:</td> <td>150.8</td> <td></td> </tr> <tr> <td>Comp. height:</td> <td>77.8</td> <td></td> </tr> <tr> <td></td> <td>-3.3</td> <td></td> </tr> <tr> <td></td> <td>-8.3</td> <td></td> </tr> </table>		Piston		Length:	150.8		Comp. height:	77.8			-3.3			-8.3			<table border="1"> <tr> <td></td> <td>Rings</td> <td></td> </tr> <tr> <td>Top:</td> <td>3.0</td> <td></td> </tr> <tr> <td>2nd:</td> <td>3.0</td> <td></td> </tr> <tr> <td>3rd:</td> <td>3.0</td> <td></td> </tr> <tr> <td>oil:</td> <td>6.0</td> <td></td> </tr> </table>		Rings		Top:	3.0		2nd:	3.0		3rd:	3.0		oil:	6.0		<table border="1"> <tr> <td></td> <td>Ø :</td> <td>45.0</td> </tr> <tr> <td>Length:</td> <td></td> <td>97.5</td> </tr> </table>		Ø :	45.0	Length:		97.5
				Liner/ Sleeve																																																					
Length:	280.0																																																								
Outside Ø:	135.0																																																								
Flange Ø:	140.6																																																								
Flange depth:	11.0																																																								
	Piston																																																								
Length:	150.8																																																								
Comp. height:	77.8																																																								
	-3.3																																																								
	-8.3																																																								
	Rings																																																								
Top:	3.0																																																								
2nd:	3.0																																																								
3rd:	3.0																																																								
oil:	6.0																																																								
	Ø :	45.0																																																							
Length:		97.5																																																							
		Reference no.:		Reference no.:	Reference no.:	Reference no.:																																																			
		9-11261-241-0 9-11261-270-0		9-12111-742-0 9-12111-849-1	1-12121-016-0 1-12181-001-0 9-12181-083-0 9-12181-086-0 9-12181-114-0	9-12251-069-0 9-12251-070-0																																																			
NM-Motorservice Article no./ Artikelnummer/ Modelo número/ статья номер	NM-Motorservice Article no.:	NM-Motorservice Article no.:	NM-Motorservice Article no.:	NM-Motorservice Article no.:	NM-Motorservice Article no.:	NM-Motorservice Article no.:																																																			
	LBS 18550 F	LB 18550 F	KBS 18550	KB 18550	KR 18550	PB 18550																																																			

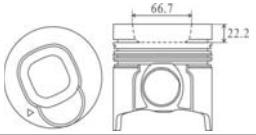

ENGINE TYPE Motortyp/ tipo de motor/ тип двигателя	LINER KIT Liner Kit/ camisas de los cilindros/ Лайнер комплект	CYL. LINER Zylinderlaufbuchse/ camisas de los cilindros/ втулка цилиндра	PISTON + RINGS Kolben + Ringe/ Pistón + Anillos/ поршень и кольца	PISTON SET Kolben Set/ Pistón Set/ поршневой	RINGS SET Ring Set/ Anillos Set/ кольца	PIN Pin/ Perno/ Пин																																								
6SD1 6SD1T 9,839 cc 6 cyl 120.0 mm Bore Ø		<table border="1"> <tr> <td></td> <td>Liner/ Sleeve</td> <td></td> </tr> <tr> <td>Length:</td> <td>239.0</td> <td></td> </tr> <tr> <td>Outside Ø:</td> <td>123.0</td> <td></td> </tr> <tr> <td>Flange Ø:</td> <td>129.6</td> <td></td> </tr> <tr> <td>Flange depth:</td> <td>6.0 +1.0</td> <td></td> </tr> </table>		Liner/ Sleeve		Length:	239.0		Outside Ø:	123.0		Flange Ø:	129.6		Flange depth:	6.0 +1.0		<table border="1"> <tr> <td></td> <td>Piston</td> <td></td> </tr> <tr> <td>Length:</td> <td>117.0</td> <td></td> </tr> <tr> <td>Comp. height:</td> <td>75.0 -24.7</td> <td></td> </tr> </table>		Piston		Length:	117.0		Comp. height:	75.0 -24.7		Alfin and with oil gallery	<table border="1"> <tr> <td></td> <td>Rings</td> <td></td> </tr> <tr> <td>Top:</td> <td>3.5</td> <td>Ø:</td> </tr> <tr> <td>2nd:</td> <td>2.5</td> <td>Length:</td> </tr> <tr> <td>oil:</td> <td>5.0</td> <td></td> </tr> </table>		Rings		Top:	3.5	Ø:	2nd:	2.5	Length:	oil:	5.0		<table border="1"> <tr> <td></td> <td>43.0</td> </tr> <tr> <td></td> <td>89.5</td> </tr> </table>		43.0		89.5
			Liner/ Sleeve																																											
Length:	239.0																																													
Outside Ø:	123.0																																													
Flange Ø:	129.6																																													
Flange depth:	6.0 +1.0																																													
	Piston																																													
Length:	117.0																																													
Comp. height:	75.0 -24.7																																													
	Rings																																													
Top:	3.5	Ø:																																												
2nd:	2.5	Length:																																												
oil:	5.0																																													
	43.0																																													
	89.5																																													
	Reference no.:	Reference no.:	Reference no.:	Reference no.:	Reference no.:																																									
	1-11261-106-2 1-11261-298-0			1-12111-591-0 1-12111-620-1	1-12121-094-1	1-12251-021-0 1-12251-021-1																																								
NM-Motorservice Article no./ Artikelnummer/ Modelo número/ статья номер	NM-Motorservice Article no.:	NM-Motorservice Article no.:	NM-Motorservice Article no.:	NM-Motorservice Article no.:	NM-Motorservice Article no.:	NM-Motorservice Article no.:																																								
	LBS 18600 FB	LB 18600 F	KBS 18600 B	KB 18600 B	KR 18600	PB 18600																																								



ENGINE TYPE Motortyp/ tipo de motor/ тип двигателя	LINER KIT Liner Kit/ camisas de los cilindros/ Лайнер комплект	CYL. LINER Zylinderlaufbuchse/ camisas de los cilindros/ втулка цилиндра	PISTON + RINGS Kolben + Ringe/ Pistón + Anillos/ поршень и кольца	PISTON SET Kolben Set/ Pistón Set/ поршневой	RINGS SET Ring Set/ Anillos Set/ кольца	PIN Pin/ Perno/ Пин																																								
6SD1 9,839 cc 6 cyl 120.0 mm Bore Ø		<table border="1"> <tr> <td></td> <td>Liner/ Sleeve</td> <td></td> </tr> <tr> <td>Length:</td> <td>239.0</td> <td></td> </tr> <tr> <td>Outside Ø:</td> <td>123.0</td> <td></td> </tr> <tr> <td>Flange Ø:</td> <td>129.6</td> <td></td> </tr> <tr> <td>Flange depth:</td> <td>6.0 +1.0</td> <td></td> </tr> </table>		Liner/ Sleeve		Length:	239.0		Outside Ø:	123.0		Flange Ø:	129.6		Flange depth:	6.0 +1.0		<table border="1"> <tr> <td></td> <td>Piston</td> <td></td> </tr> <tr> <td>Length:</td> <td>117.0</td> <td></td> </tr> <tr> <td>Comp. height:</td> <td>75.0 -24.7</td> <td></td> </tr> </table>		Piston		Length:	117.0		Comp. height:	75.0 -24.7			<table border="1"> <tr> <td></td> <td>Rings</td> <td></td> </tr> <tr> <td>Top:</td> <td>3.5</td> <td>Ø:</td> </tr> <tr> <td>2nd:</td> <td>2.5</td> <td>Length:</td> </tr> <tr> <td>oil:</td> <td>5.0</td> <td></td> </tr> </table>		Rings		Top:	3.5	Ø:	2nd:	2.5	Length:	oil:	5.0		<table border="1"> <tr> <td></td> <td>43.0</td> </tr> <tr> <td></td> <td>89.5</td> </tr> </table>		43.0		89.5
			Liner/ Sleeve																																											
Length:	239.0																																													
Outside Ø:	123.0																																													
Flange Ø:	129.6																																													
Flange depth:	6.0 +1.0																																													
	Piston																																													
Length:	117.0																																													
Comp. height:	75.0 -24.7																																													
	Rings																																													
Top:	3.5	Ø:																																												
2nd:	2.5	Length:																																												
oil:	5.0																																													
	43.0																																													
	89.5																																													
	Reference no.:	Reference no.:	Reference no.:	Reference no.:	Reference no.:																																									
	1-11261-106-2 1-11261-298-0			1-12111-569-0	1-12121-094-1	1-12251-021-0 1-12251-021-1																																								
NM-Motorservice Article no./ Artikelnummer/ Modelo número/ статья номер	NM-Motorservice Article no.:	NM-Motorservice Article no.:	NM-Motorservice Article no.:	NM-Motorservice Article no.:	NM-Motorservice Article no.:	NM-Motorservice Article no.:																																								
	LBS 18650 FA	LB 18650 F (phosphated)	KBS 18650 A	KB 18650 A	KR 18650	PB 18650																																								

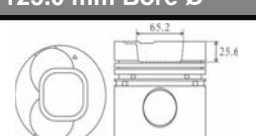

ENGINE TYPE Motortyp/ tipo de motor/ тип двигателя	LINER KIT Liner Kit/ camisas de los cilindros/ Лайнер комплект	CYL. LINER Zylinderlaufbuchse/ camisas de los cilindros/ втулка цилиндра	PISTON + RINGS Kolben + Ringe/ Pistón + Anillos/ поршень и кольца	PISTON SET Kolben Set/ Pistón Set/ поршневой	RINGS SET Ring Set/ Anillos Set/ кольца	PIN Pin/ Perno/ Пин																																								
6SD1T New 9,839 cc 6 cyl 120.0 mm Bore Ø		<table border="1"> <tr> <td></td> <td>Liner/ Sleeve</td> <td></td> </tr> <tr> <td>Length:</td> <td>239.0</td> <td></td> </tr> <tr> <td>Outside Ø:</td> <td>123.0</td> <td></td> </tr> <tr> <td>Flange Ø:</td> <td>129.6</td> <td></td> </tr> <tr> <td>Flange depth:</td> <td>6.0 +1.0</td> <td></td> </tr> </table>		Liner/ Sleeve		Length:	239.0		Outside Ø:	123.0		Flange Ø:	129.6		Flange depth:	6.0 +1.0		<table border="1"> <tr> <td></td> <td>Piston</td> <td></td> </tr> <tr> <td>Length:</td> <td>117.0</td> <td></td> </tr> <tr> <td>Comp. height:</td> <td>75.0 -1.3 -24.4</td> <td></td> </tr> </table>		Piston		Length:	117.0		Comp. height:	75.0 -1.3 -24.4		Alfin and with oil gallery	<table border="1"> <tr> <td></td> <td>Rings</td> <td></td> </tr> <tr> <td>Top:</td> <td>3.5</td> <td>Ø:</td> </tr> <tr> <td>2nd:</td> <td>2.5</td> <td>Length:</td> </tr> <tr> <td>oil:</td> <td>5.0</td> <td></td> </tr> </table>		Rings		Top:	3.5	Ø:	2nd:	2.5	Length:	oil:	5.0		<table border="1"> <tr> <td></td> <td>43.0</td> </tr> <tr> <td></td> <td>89.5</td> </tr> </table>		43.0		89.5
			Liner/ Sleeve																																											
Length:	239.0																																													
Outside Ø:	123.0																																													
Flange Ø:	129.6																																													
Flange depth:	6.0 +1.0																																													
	Piston																																													
Length:	117.0																																													
Comp. height:	75.0 -1.3 -24.4																																													
	Rings																																													
Top:	3.5	Ø:																																												
2nd:	2.5	Length:																																												
oil:	5.0																																													
	43.0																																													
	89.5																																													
	Reference no.:	Reference no.:	Reference no.:	Reference no.:	Reference no.:																																									
	1-11261-106-2 1-11261-298-0				1-12121-094-1	1-12251-021-0 1-12251-021-1																																								
NM-Motorservice Article no./ Artikelnummer/ Modelo número/ статья номер	NM-Motorservice Article no.:	NM-Motorservice Article no.:	NM-Motorservice Article no.:	NM-Motorservice Article no.:	NM-Motorservice Article no.:	NM-Motorservice Article no.:																																								
	LBS 18700 FB	LB 18700 F (phosphated)	KBS 18700 B	KB 18700 B	KR 18700	PB 18700																																								

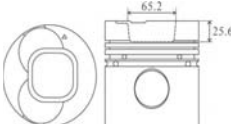

ENGINE TYPE Motortyp/ tipo de motor/ тип двигателя	LINER KIT Liner Kit/ camisas de los cilindros/ Лайнер комплект	CYL. LINER Zylinderlaufbuchse/ camisas de los cilindros/ втулка цилиндра	PISTON + RINGS Kolben + Ringe/ Pistón + Anillos/ поршень и кольца	PISTON SET Kolben Set/ Pistón Set/ поршневой	RINGS SET Ring Set/ Anillos Set/ кольца	PIN Pin/ Perno/ Пин																																												
6SD1T 9,839 cc 6 cyl 120.0 mm Bore Ø		<table border="1"> <tr> <td></td> <td>Liner/ Sleeve</td> <td></td> </tr> <tr> <td>Length:</td> <td>239.0</td> <td></td> </tr> <tr> <td>Outside Ø:</td> <td>123.0</td> <td></td> </tr> <tr> <td>Flange Ø:</td> <td>129.6</td> <td></td> </tr> <tr> <td>Flange depth:</td> <td>6.0 +1.0</td> <td></td> </tr> </table>		Liner/ Sleeve		Length:	239.0		Outside Ø:	123.0		Flange Ø:	129.6		Flange depth:	6.0 +1.0		<table border="1"> <tr> <td></td> <td>Piston</td> <td></td> </tr> <tr> <td>Length:</td> <td>127.5</td> <td></td> </tr> <tr> <td>Comp. height:</td> <td>75.0 -22.2</td> <td></td> </tr> </table>		Piston		Length:	127.5		Comp. height:	75.0 -22.2		Alfin and with oil gallery	<table border="1"> <tr> <td></td> <td>Rings</td> <td></td> </tr> <tr> <td>Top:</td> <td>4.0</td> <td rowspan="4">Ø : Length:</td> </tr> <tr> <td>2nd:</td> <td>3.0</td> </tr> <tr> <td>3rd:</td> <td>3.0</td> </tr> <tr> <td>oil:</td> <td>4.0</td> </tr> </table>		Rings		Top:	4.0	Ø : Length:	2nd:	3.0	3rd:	3.0	oil:	4.0	<table border="1"> <tr> <td></td> <td></td> <td></td> </tr> <tr> <td>Ø :</td> <td>43.0</td> <td rowspan="2">Length:</td> </tr> <tr> <td>Length:</td> <td>89.5</td> </tr> </table>				Ø :	43.0	Length:	Length:	89.5
				Liner/ Sleeve																																														
Length:	239.0																																																	
Outside Ø:	123.0																																																	
Flange Ø:	129.6																																																	
Flange depth:	6.0 +1.0																																																	
	Piston																																																	
Length:	127.5																																																	
Comp. height:	75.0 -22.2																																																	
	Rings																																																	
Top:	4.0	Ø : Length:																																																
2nd:	3.0																																																	
3rd:	3.0																																																	
oil:	4.0																																																	
Ø :	43.0	Length:																																																
Length:	89.5																																																	
		Reference no.:		Reference no.:	Reference no.:	Reference no.:																																												
		1-11261-106-2 1-11261-298-0		1-12121-119-2	1-12121-119-2	1-12251-021-0 1-12251-021-1																																												
NM-Motorservice Article no./ Artikelnummer/ Modelo número/ статья номер	NM-Motorservice Article no.:	NM-Motorservice Article no.:	NM-Motorservice Article no.:	NM-Motorservice Article no.:	NM-Motorservice Article no.:	NM-Motorservice Article no.:																																												
	LBS 18750 FB	LB 18750 F (phosphated)	KBS 18750 B	KB 18750 B	KR 18750	PB 18750																																												



ENGINE TYPE Motortyp/ tipo de motor/ тип двигателя	LINER KIT Liner Kit/ camisas de los cilindros/ Лайнер комплект	CYL. LINER Zylinderlaufbuchse/ camisas de los cilindros/ втулка цилиндра	PISTON + RINGS Kolben + Ringe/ Pistón + Anillos/ поршень и кольца	PISTON SET Kolben Set/ Pistón Set/ поршневой	RINGS SET Ring Set/ Anillos Set/ кольца	PIN Pin/ Perno/ Пин																																												
6SD1TC 9,839 cc 6 cyl 120.0 mm Bore Ø		<table border="1"> <tr> <td></td> <td>Liner/ Sleeve</td> <td></td> </tr> <tr> <td>Length:</td> <td>239.0</td> <td></td> </tr> <tr> <td>Outside Ø:</td> <td>123.0</td> <td></td> </tr> <tr> <td>Flange Ø:</td> <td>129.6</td> <td></td> </tr> <tr> <td>Flange depth:</td> <td>6.0 +1.0</td> <td></td> </tr> </table>		Liner/ Sleeve		Length:	239.0		Outside Ø:	123.0		Flange Ø:	129.6		Flange depth:	6.0 +1.0		<table border="1"> <tr> <td></td> <td>Piston</td> <td></td> </tr> <tr> <td>Length:</td> <td>117.5</td> <td></td> </tr> <tr> <td>Comp. height:</td> <td>75.0</td> <td></td> </tr> </table>		Piston		Length:	117.5		Comp. height:	75.0		Alfin and with oil gallery	<table border="1"> <tr> <td></td> <td>Rings</td> <td></td> </tr> <tr> <td>Top:</td> <td>4.0</td> <td rowspan="4">Ø : Length:</td> </tr> <tr> <td>2nd:</td> <td>3.0</td> </tr> <tr> <td>3rd:</td> <td>3.0</td> </tr> <tr> <td>oil:</td> <td>4.0</td> </tr> </table>		Rings		Top:	4.0	Ø : Length:	2nd:	3.0	3rd:	3.0	oil:	4.0	<table border="1"> <tr> <td></td> <td></td> <td></td> </tr> <tr> <td>Ø :</td> <td>43.0</td> <td rowspan="2">Length:</td> </tr> <tr> <td>Length:</td> <td>89.5</td> </tr> </table>				Ø :	43.0	Length:	Length:	89.5
				Liner/ Sleeve																																														
Length:	239.0																																																	
Outside Ø:	123.0																																																	
Flange Ø:	129.6																																																	
Flange depth:	6.0 +1.0																																																	
	Piston																																																	
Length:	117.5																																																	
Comp. height:	75.0																																																	
	Rings																																																	
Top:	4.0	Ø : Length:																																																
2nd:	3.0																																																	
3rd:	3.0																																																	
oil:	4.0																																																	
Ø :	43.0	Length:																																																
Length:	89.5																																																	
		Reference no.:		Reference no.:	Reference no.:	Reference no.:																																												
		1-11261-106-2 1-11261-298-0		1-12111-913-0	1-12121-119-2	1-12251-021-0 1-12251-021-1																																												
NM-Motorservice Article no./ Artikelnummer/ Modelo número/ статья номер	NM-Motorservice Article no.:	NM-Motorservice Article no.:	NM-Motorservice Article no.:	NM-Motorservice Article no.:	NM-Motorservice Article no.:	NM-Motorservice Article no.:																																												
	LBS 18800 FB	LB 18800 F (phosphated)	KBS 18800 B	KB 18800 B	KR 18800	PB 18800																																												

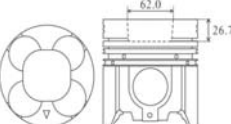

ENGINE TYPE Motortyp/ tipo de motor/ тип двигателя	LINER KIT Liner Kit/ camisas de los cilindros/ Лайнер комплект	CYL. LINER Zylinderlaufbuchse/ camisas de los cilindros/ втулка цилиндра	PISTON + RINGS Kolben + Ringe/ Pistón + Anillos/ поршень и кольца	PISTON SET Kolben Set/ Pistón Set/ поршневой	RINGS SET Ring Set/ Anillos Set/ кольца	PIN Pin/ Perno/ Пин																																												
6QA1 11,044 cc 6 cyl 125.0 mm Bore Ø		<table border="1"> <tr> <td></td> <td>Liner/ Sleeve</td> <td></td> </tr> <tr> <td>Length:</td> <td>282.0</td> <td></td> </tr> <tr> <td>Outside Ø:</td> <td>140.0</td> <td></td> </tr> <tr> <td>Flange Ø:</td> <td>146.7</td> <td></td> </tr> <tr> <td>Flange depth:</td> <td>11.0 +2.0</td> <td></td> </tr> </table>		Liner/ Sleeve		Length:	282.0		Outside Ø:	140.0		Flange Ø:	146.7		Flange depth:	11.0 +2.0		<table border="1"> <tr> <td></td> <td>Piston</td> <td></td> </tr> <tr> <td>Length:</td> <td>136.0</td> <td></td> </tr> <tr> <td>Comp. height:</td> <td>83.2 -1.0 -25.6</td> <td></td> </tr> </table>		Piston		Length:	136.0		Comp. height:	83.2 -1.0 -25.6			<table border="1"> <tr> <td></td> <td>Rings</td> <td></td> </tr> <tr> <td>Top:</td> <td>3.0</td> <td rowspan="4">Ø : Length:</td> </tr> <tr> <td>2nd:</td> <td>2.5</td> </tr> <tr> <td>oil:</td> <td>6.0</td> </tr> <tr> <td></td> <td></td> </tr> </table>		Rings		Top:	3.0	Ø : Length:	2nd:	2.5	oil:	6.0			<table border="1"> <tr> <td></td> <td></td> <td></td> </tr> <tr> <td>Ø :</td> <td>46.0</td> <td rowspan="2">Length:</td> </tr> <tr> <td>Length:</td> <td>106.0</td> </tr> </table>				Ø :	46.0	Length:	Length:	106.0
				Liner/ Sleeve																																														
Length:	282.0																																																	
Outside Ø:	140.0																																																	
Flange Ø:	146.7																																																	
Flange depth:	11.0 +2.0																																																	
	Piston																																																	
Length:	136.0																																																	
Comp. height:	83.2 -1.0 -25.6																																																	
	Rings																																																	
Top:	3.0	Ø : Length:																																																
2nd:	2.5																																																	
oil:	6.0																																																	
Ø :	46.0	Length:																																																
Length:	106.0																																																	
		Reference no.:		Reference no.:	Reference no.:	Reference no.:																																												
		1-11261-074-0 1-11261-061-1			1-12121-028 1-12121-046	9-12251-073-0 9-12251-074-1																																												
NM-Motorservice Article no./ Artikelnummer/ Modelo número/ статья номер	NM-Motorservice Article no.:	NM-Motorservice Article no.:	NM-Motorservice Article no.:	NM-Motorservice Article no.:	NM-Motorservice Article no.:	NM-Motorservice Article no.:																																												
	LBS 18850 FA	LB 18850 F (Water jacket chromed)	KBS 18850 A	KB 18850A	KR 18850	PB 18850																																												

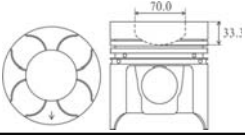

ENGINE TYPE Motortyp/ tipo de motor/ тип двигателя	LINER KIT Liner Kit/ camisas de los cilindros/ Лайнер комплект	CYL. LINER Zylinderlaufbuchse/ camisas de los cilindros/ втулка цилиндра	PISTON + RINGS Kolben + Ringe/ Pistón + Anillos/ поршень и кольца	PISTON SET Kolben Set/ Pistón Set/ поршневой	RINGS SET Ring Set/ Anillos Set/ кольца	PIN Pin/ Perno/ Пин
6QA1 11,044 cc 6 cyl 125.0 mm Bore Ø		Liner/ Sleeve	Piston		Rings	Ø : 46.0 Length: 106.0
		Length: 257.0 Outside Ø: 140.0 Flange Ø: 146.7 Flange depth: 11.0 +2.0				
		Reference no.:			Reference no.:	Reference no.:
		1-11261-160-0				
NM-Motorservice Article no./ Artikelnummer/ Modelo número/ статья номер	NM-Motorservice Article no.:	NM-Motorservice Article no.:	NM-Motorservice Article no.:	NM-Motorservice Article no.:	NM-Motorservice Article no.:	NM-Motorservice Article no.:
	LBS 18900 FA	LB 18900 F (phosphated and water jacked chromed)	KBS 18900 A	KB 18900 A	KR 18900	PB 18900

ENGINE TYPE Motortyp/ tipo de motor/ тип двигателя	LINER KIT Liner Kit/ camisas de los cilindros/ Лайнер комплект	CYL. LINER Zylinderlaufbuchse/ camisas de los cilindros/ втулка цилиндра	PISTON + RINGS Kolben + Ringe/ Pistón + Anillos/ поршень и кольца	PISTON SET Kolben Set/ Pistón Set/ поршневой	RINGS SET Ring Set/ Anillos Set/ кольца	PIN Pin/ Perno/ Пин
6WA1-TC 12,068 cc 6 cyl 132.9 mm Bore Ø		Liner/ Sleeve	Piston		Rings	Ø : 56.0 Length: 105.0
		Length: 266.0 Outside Ø: 137.0 Flange Ø: 143.7 Flange depth: 6.0				
		Reference no.:			Reference no.:	Reference no.:
		1-11261-296-0 1-11261-362-0				
NM-Motorservice Article no./ Artikelnummer/ Modelo número/ статья номер	NM-Motorservice Article no.:	NM-Motorservice Article no.:	NM-Motorservice Article no.:	NM-Motorservice Article no.:	NM-Motorservice Article no.:	NM-Motorservice Article no.:
	LBS 18950 FA	LB 18950 F	KBS 18950 A	KB 18950 A	KR 18950	PB 18950

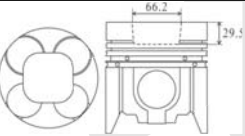
ENGINE TYPE Motortyp/ tipo de motor/ тип двигателя	LINER KIT Liner Kit/ camisas de los cilindros/ Лайнер комплект	CYL. LINER Zylinderlaufbuchse/ camisas de los cilindros/ втулка цилиндра	PISTON + RINGS Kolben + Ringe/ Pistón + Anillos/ поршень и кольца	PISTON SET Kolben Set/ Pistón Set/ поршневой	RINGS SET Ring Set/ Anillos Set/ кольца	PIN Pin/ Perno/ Пин
E120 12,023 cc 6 cyl 135.0 mm Bore Ø		Liner/ Sleeve	Piston		Rings	Ø : 50.0 Length: 105.0
		Length: 264.0 Outside Ø: 141.0 Flange Ø: 146.7 Flange depth: 6.0				
		Reference no.:			Reference no.:	Reference no.:
		9-12261-290-0				
NM-Motorservice Article no./ Artikelnummer/ Modelo número/ статья номер	NM-Motorservice Article no.:	NM-Motorservice Article no.:	NM-Motorservice Article no.:	NM-Motorservice Article no.:	NM-Motorservice Article no.:	NM-Motorservice Article no.:
	LBS 25150 FA	LB 25150 F (phosphated)	KBS 25150 A	KB 25150 A	KR 25150	PB 25150

ENGINE TYPE Motor/typo/ tipo de motor/ тип двигателя	LINER KIT Liner Kit/ camisas de los cilindros/ Лайнер комплект	CYL. LINER Zylinderlaufbuchse/ camisas de los cilindros/ втулка цилиндра	PISTON + RINGS Kolben + Ringe/ Pistón + Anillos/ поршень и кольца	PISTON SET Kolben Set/ Pistón Set/ поршневой	RINGS SET Ring Set/ Anillos Set/ кольца	PIN Pin/ Perno/ Пин	
E120 12,023 cc 6 cyl 135.0 mm Bore Ø		Liner/ Sleeve	Piston		Rings		
		Length: Outside Ø: Flange Ø: Flange depth:	264.0 141.0 146.7 6.0	Length: Comp. height:	150.3 89.1 -33.3	Top: 2nd: oil:	4.0 2.5 7.0
		Reference no.:			Reference no.:	Reference no.:	Reference no.:
		9-12261-290-0			1-12111-080-1 1-12111-080-2 1-12111-091-1 1-12111-243-0	1-12121-015-0 1-12121-034-0 1-12181-022-0 1-12181-024-0	9-12251-088-0
NM-Motorservice Article no./ Artikelnummer/ Modelo número/ статья номер	NM-Motorservice Article no.:	NM-Motorservice Article no.:	NM-Motorservice Article no.:	NM-Motorservice Article no.:	NM-Motorservice Article no.:	NM-Motorservice Article no.:	
	LBS 19050 FA	LB 19050 F (phosphated)	KBS 19050 A	KB 19050 A	KR 19050	PB 19050	

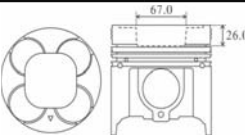

ENGINE TYPE Motor/typo/ tipo de motor/ тип двигателя	LINER KIT Liner Kit/ camisas de los cilindros/ Лайнер комплект	CYL. LINER Zylinderlaufbuchse/ camisas de los cilindros/ втулка цилиндра	PISTON + RINGS Kolben + Ringe/ Pistón + Anillos/ поршень и кольца	PISTON SET Kolben Set/ Pistón Set/ поршневой	RINGS SET Ring Set/ Anillos Set/ кольца	PIN Pin/ Perno/ Пин	
E120T 12,023 cc 6 cyl 135.0 mm Bore Ø		Liner/ Sleeve	Piston		Rings		
		Length: Outside Ø: Flange Ø: Flange depth:	264.0 141.0 146.7 6.0	Length: Comp. height:	150.0 89.2 -29.5	Top: 2nd: oil:	4.0 2.5 7.0
		Reference no.:			Reference no.:	Reference no.:	Reference no.:
		9-12261-290-0			1-12111-209-2 1-12111-226-2	1-12121-015-0 1-12121-034-0 1-12181-022-0 1-12181-024-0	9-12251-088-0
NM-Motorservice Article no./ Artikelnummer/ Modelo número/ статья номер	NM-Motorservice Article no.:	NM-Motorservice Article no.:	NM-Motorservice Article no.:	NM-Motorservice Article no.:	NM-Motorservice Article no.:	NM-Motorservice Article no.:	
	LBS 19100 FA	LB 19100 F (phosphated)	KBS 19100 A	KB 19100 A	KR 19100	PB 19100	



ENGINE TYPE Motor/typo/ tipo de motor/ тип двигателя	LINER KIT Liner Kit/ camisas de los cilindros/ Лайнер комплект	CYL. LINER Zylinderlaufbuchse/ camisas de los cilindros/ втулка цилиндра	PISTON + RINGS Kolben + Ringe/ Pistón + Anillos/ поршень и кольца	PISTON SET Kolben Set/ Pistón Set/ поршневой	RINGS SET Ring Set/ Anillos Set/ кольца	PIN Pin/ Perno/ Пин	
6RA1 13,741 cc 6 cyl 135.0 mm Bore Ø		Liner/ Sleeve	Piston		Rings		
		Length: Outside Ø: Flange Ø: Flange depth:	264.0 141.0 146.7 6.0	Length: Comp. height:	150.2 89.2 -26.0	Top: 2nd: oil:	4.0 2.5 5.0
		Reference no.:			Reference no.:	Reference no.:	Reference no.:
		1-11261-082-0 1-11261-098-0 1-11261-133-0 1-11261-105-1			1-12111-461-0	1-12121-037-0 1-12121-040-0	9-12251-088-0
NM-Motorservice Article no./ Artikelnummer/ Modelo número/ статья номер	NM-Motorservice Article no.:	NM-Motorservice Article no.:	NM-Motorservice Article no.:	NM-Motorservice Article no.:	NM-Motorservice Article no.:	NM-Motorservice Article no.:	
	LBS 19150 FA	LB 19150 F (phosphated)	KBS 19150 A	KB 19150 A	KR 19150	PB 19150	

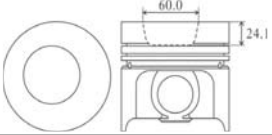

ENGINE TYPE Motortyp/ tipo de motor/ тип двигателя	LINER KIT Liner Kit/ camisas de los cilindros/ Лайнер комплект	CYL. LINER Zylinderlaufbuchse/ camisas de los cilindros/ втулка цилиндра	PISTON + RINGS Kolben + Ringe/ Pistón + Anillos/ поршень и кольца	PISTON SET Kolben Set/ Pistón Set/ поршневой	RINGS SET Ring Set/ Anillos Set/ кольца	PIN Pin/ Perno/ Пин																																																
6RB1		<table border="1"> <tr> <td></td> <td>Liner/ Sleeve</td> <td></td> </tr> <tr> <td>Length:</td> <td>264.0</td> <td></td> </tr> <tr> <td>Outside Ø:</td> <td>141.0</td> <td></td> </tr> <tr> <td>Flange Ø:</td> <td>146.7</td> <td></td> </tr> <tr> <td>Flange depth:</td> <td>6.0</td> <td></td> </tr> </table>		Liner/ Sleeve		Length:	264.0		Outside Ø:	141.0		Flange Ø:	146.7		Flange depth:	6.0		<table border="1"> <tr> <td></td> <td>Piston</td> <td></td> </tr> <tr> <td>Length:</td> <td>143.1</td> <td></td> </tr> <tr> <td>Comp. height:</td> <td>82.2</td> <td></td> </tr> <tr> <td></td> <td>-27.7</td> <td></td> </tr> </table>		Piston		Length:	143.1		Comp. height:	82.2			-27.7			<table border="1"> <tr> <td></td> <td>Rings</td> <td></td> </tr> <tr> <td>Top:</td> <td>4.0</td> <td>Ø:</td> </tr> <tr> <td>2nd:</td> <td>2.5</td> <td>Length:</td> </tr> <tr> <td>oil:</td> <td>5.0</td> <td></td> </tr> <tr> <td></td> <td></td> <td></td> </tr> <tr> <td></td> <td></td> <td>50.0</td> </tr> <tr> <td></td> <td></td> <td>105.0</td> </tr> </table>		Rings		Top:	4.0	Ø:	2nd:	2.5	Length:	oil:	5.0							50.0			105.0	
				Liner/ Sleeve																																																		
Length:	264.0																																																					
Outside Ø:	141.0																																																					
Flange Ø:	146.7																																																					
Flange depth:	6.0																																																					
	Piston																																																					
Length:	143.1																																																					
Comp. height:	82.2																																																					
	-27.7																																																					
	Rings																																																					
Top:	4.0	Ø:																																																				
2nd:	2.5	Length:																																																				
oil:	5.0																																																					
		50.0																																																				
		105.0																																																				
13,741 cc 6 cyl 135.0 mm Bore Ø																																																						
		Reference no.:		Reference no.:	Reference no.:	Reference no.:																																																
		1-11261-082-0 1-11261-098-0 1-11261-133-0 1-11261-105-1		1-12111-245-0	1-12121-037-0 1-12121-040-0	9-12251-088-0																																																
NM-Motorservice Article no./ Artikelnummer/ Modelo número/ статья номер	NM-Motorservice Article no.:	NM-Motorservice Article no.:	NM-Motorservice Article no.:	NM-Motorservice Article no.:	NM-Motorservice Article no.:	NM-Motorservice Article no.:																																																
	LBS 19200 FA	LB 19200 F (phosphated)	KBS 19200 A	KB 19200 A	KR 19200	PB 19200																																																

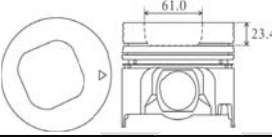

ENGINE TYPE Motortyp/ tipo de motor/ тип двигателя	LINER KIT Liner Kit/ camisas de los cilindros/ Лайнер комплект	CYL. LINER Zylinderlaufbuchse/ camisas de los cilindros/ втулка цилиндра	PISTON + RINGS Kolben + Ringe/ Pistón + Anillos/ поршень и кольца	PISTON SET Kolben Set/ Pistón Set/ поршневой	RINGS SET Ring Set/ Anillos Set/ кольца	PIN Pin/ Perno/ Пин																																																
6RB1T		<table border="1"> <tr> <td></td> <td>Liner/ Sleeve</td> <td></td> </tr> <tr> <td>Length:</td> <td>264.0</td> <td></td> </tr> <tr> <td>Outside Ø:</td> <td>141.0</td> <td></td> </tr> <tr> <td>Flange Ø:</td> <td>146.7</td> <td></td> </tr> <tr> <td>Flange depth:</td> <td>6.0</td> <td></td> </tr> </table>		Liner/ Sleeve		Length:	264.0		Outside Ø:	141.0		Flange Ø:	146.7		Flange depth:	6.0		<table border="1"> <tr> <td></td> <td>Piston</td> <td></td> </tr> <tr> <td>Length:</td> <td>137.1</td> <td></td> </tr> <tr> <td>Comp. height:</td> <td>82.1</td> <td></td> </tr> <tr> <td></td> <td>-25.7</td> <td></td> </tr> </table>		Piston		Length:	137.1		Comp. height:	82.1			-25.7		Alfin and with oil gallery	<table border="1"> <tr> <td></td> <td>Rings</td> <td></td> </tr> <tr> <td>Top:</td> <td>4.0</td> <td>Ø:</td> </tr> <tr> <td>2nd:</td> <td>2.5</td> <td>Length:</td> </tr> <tr> <td>oil:</td> <td>4.0</td> <td></td> </tr> <tr> <td></td> <td></td> <td></td> </tr> <tr> <td></td> <td></td> <td>52.0</td> </tr> <tr> <td></td> <td></td> <td>105.0</td> </tr> </table>		Rings		Top:	4.0	Ø:	2nd:	2.5	Length:	oil:	4.0							52.0			105.0	
				Liner/ Sleeve																																																		
Length:	264.0																																																					
Outside Ø:	141.0																																																					
Flange Ø:	146.7																																																					
Flange depth:	6.0																																																					
	Piston																																																					
Length:	137.1																																																					
Comp. height:	82.1																																																					
	-25.7																																																					
	Rings																																																					
Top:	4.0	Ø:																																																				
2nd:	2.5	Length:																																																				
oil:	4.0																																																					
		52.0																																																				
		105.0																																																				
13,741 cc 6 cyl 135.0 mm Bore Ø																																																						
		Reference no.:		Reference no.:	Reference no.:	Reference no.:																																																
		1-11261-082-0 1-11261-098-0 1-11261-133-0 1-11261-105-1		1-12111-516-0	1-12121-073-0 1-1212-102-1 1-12121-073-2	1-12251-025-0																																																
NM-Motorservice Article no./ Artikelnummer/ Modelo número/ статья номер	NM-Motorservice Article no.:	NM-Motorservice Article no.:	NM-Motorservice Article no.:	NM-Motorservice Article no.:	NM-Motorservice Article no.:	NM-Motorservice Article no.:																																																
	LBS 19250 FB	LB 19250 F (phosphated)	KBS 19250 B	KB 19250 B	KR 19250	PB 19250																																																

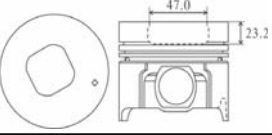

ENGINE TYPE Motortyp/ tipo de motor/ тип двигателя	LINER KIT Liner Kit/ camisas de los cilindros/ Лайнер комплект	CYL. LINER Zylinderlaufbuchse/ camisas de los cilindros/ втулка цилиндра	PISTON + RINGS Kolben + Ringe/ Pistón + Anillos/ поршень и кольца	PISTON SET Kolben Set/ Pistón Set/ поршневой	RINGS SET Ring Set/ Anillos Set/ кольца	PIN Pin/ Perno/ Пин																																																
6RA1T		<table border="1"> <tr> <td></td> <td>Liner/ Sleeve</td> <td></td> </tr> <tr> <td>Length:</td> <td>264.0</td> <td></td> </tr> <tr> <td>Outside Ø:</td> <td>141.0</td> <td></td> </tr> <tr> <td>Flange Ø:</td> <td>146.7</td> <td></td> </tr> <tr> <td>Flange depth:</td> <td>6.0</td> <td></td> </tr> </table>		Liner/ Sleeve		Length:	264.0		Outside Ø:	141.0		Flange Ø:	146.7		Flange depth:	6.0		<table border="1"> <tr> <td></td> <td>Piston</td> <td></td> </tr> <tr> <td>Length:</td> <td>150.2</td> <td></td> </tr> <tr> <td>Comp. height:</td> <td>89.2</td> <td></td> </tr> <tr> <td></td> <td>-27.0</td> <td></td> </tr> </table>		Piston		Length:	150.2		Comp. height:	89.2			-27.0			<table border="1"> <tr> <td></td> <td>Rings</td> <td></td> </tr> <tr> <td>Top:</td> <td>4.0</td> <td>Ø:</td> </tr> <tr> <td>2nd:</td> <td>2.5</td> <td>Length:</td> </tr> <tr> <td>oil:</td> <td>5.0</td> <td></td> </tr> <tr> <td></td> <td></td> <td></td> </tr> <tr> <td></td> <td></td> <td>50.0</td> </tr> <tr> <td></td> <td></td> <td>104.0</td> </tr> </table>		Rings		Top:	4.0	Ø:	2nd:	2.5	Length:	oil:	5.0							50.0			104.0	
				Liner/ Sleeve																																																		
Length:	264.0																																																					
Outside Ø:	141.0																																																					
Flange Ø:	146.7																																																					
Flange depth:	6.0																																																					
	Piston																																																					
Length:	150.2																																																					
Comp. height:	89.2																																																					
	-27.0																																																					
	Rings																																																					
Top:	4.0	Ø:																																																				
2nd:	2.5	Length:																																																				
oil:	5.0																																																					
		50.0																																																				
		104.0																																																				
13,741 cc 6 cyl 135.0 mm Bore Ø																																																						
		Reference no.:		Reference no.:	Reference no.:	Reference no.:																																																
		1-11261-082-0 1-11261-098-0 1-11261-133-0 1-11261-105-1		1-12111-481-0 1-12111-482-0	1-12121-037-0 1-12121-040-0	9-12251-088-0																																																
NM-Motorservice Article no./ Artikelnummer/ Modelo número/ статья номер	NM-Motorservice Article no.:	NM-Motorservice Article no.:	NM-Motorservice Article no.:	NM-Motorservice Article no.:	NM-Motorservice Article no.:	NM-Motorservice Article no.:																																																
	LBS 19300 FA	LB 19300 F (phosphated)	KBS 19300 A	KB 19300 A	KR 19300	PB 19300																																																

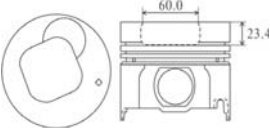

ENGINE TYPE Motortyp/ tipo de motor/ тип двигателя	LINER KIT Liner Kit/ camisas de los cilindros/ Лайнер комплект	CYL. LINER Zylinderlaufbuchse/ camisas de los cilindros/ втулка цилиндра	PISTON + RINGS Kolben + Ringe/ Pistón + Anillos/ поршень и кольца	PISTON SET Kolben Set/ Pistón Set/ поршневой	RINGS SET Ring Set/ Anillos Set/ кольца	PIN Pin/ Perno/ Пин																																		
PA1 Bore Ø 115.0 mm 8 PA1 8 cyl. 9,971 cc 10 PA1 10 cyl. 12,464 cc 12 PA1 12 cyl. 14,958 cc		<table border="1"> <tr> <td></td> <td>Liner/ Sleeve</td> <td></td> </tr> <tr> <td>Length:</td> <td>219.5</td> <td></td> </tr> <tr> <td>Outside Ø:</td> <td>130.0</td> <td></td> </tr> <tr> <td>Flange Ø:</td> <td>141.7</td> <td></td> </tr> <tr> <td>Flange depth:</td> <td>10.0 +1.2</td> <td></td> </tr> </table>		Liner/ Sleeve		Length:	219.5		Outside Ø:	130.0		Flange Ø:	141.7		Flange depth:	10.0 +1.2		<table border="1"> <tr> <td></td> <td>Piston</td> <td></td> </tr> <tr> <td>Length:</td> <td>113.3</td> <td></td> </tr> <tr> <td>Comp. height:</td> <td>75.3 -24.1</td> <td></td> </tr> </table>		Piston		Length:	113.3		Comp. height:	75.3 -24.1			<table border="1"> <tr> <td></td> <td>Rings</td> <td></td> </tr> <tr> <td>Top:</td> <td>3.0</td> <td rowspan="3">Ø : 38.0 Length: 80.0</td> </tr> <tr> <td>2nd:</td> <td>2.5</td> </tr> <tr> <td>oil:</td> <td>6.0</td> </tr> </table>		Rings		Top:	3.0	Ø : 38.0 Length: 80.0	2nd:	2.5	oil:	6.0	
			Liner/ Sleeve																																					
		Length:	219.5																																					
Outside Ø:	130.0																																							
Flange Ø:	141.7																																							
Flange depth:	10.0 +1.2																																							
	Piston																																							
Length:	113.3																																							
Comp. height:	75.3 -24.1																																							
	Rings																																							
Top:	3.0	Ø : 38.0 Length: 80.0																																						
2nd:	2.5																																							
oil:	6.0																																							
Reference no.:	Reference no.:	Reference no.:	Reference no.:	Reference no.:	Reference no.:																																			
1-11261-063-0	2 cyls pack	2 cyls pack	O-Ring: 1 cyl pack	1-12111-154-1 1 cyl pack	1-12121-042-0 1-12181-016-0 1-12181-060-0 1 cyl pack	1-12251-001-0 2 cyls pack																																		
NM-Motorservice Article no./ Artikelnummer/ Modelo número/ статья номер	NM-Motorservice Article no.:	NM-Motorservice Article no.:	NM-Motorservice Article no.:	NM-Motorservice Article no.:	NM-Motorservice Article no.:	NM-Motorservice Article no.:																																		
	LBS 19350 FA LBS 19350-1 FA LBS 19350-2 FA	LB 19350 F LB 19350 -1 F LB 19350 -2 F	KBS 19350 A	KB 19350 A	KR 19350	PB 19350																																		

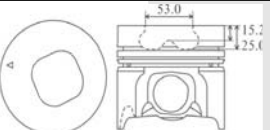

ENGINE TYPE Motortyp/ tipo de motor/ тип двигателя	LINER KIT Liner Kit/ camisas de los cilindros/ Лайнер комплект	CYL. LINER Zylinderlaufbuchse/ camisas de los cilindros/ втулка цилиндра	PISTON + RINGS Kolben + Ringe/ Pistón + Anillos/ поршень и кольца	PISTON SET Kolben Set/ Pistón Set/ поршневой	RINGS SET Ring Set/ Anillos Set/ кольца	PIN Pin/ Perno/ Пин																																		
PB1 Bore Ø 115.0 mm 8 PB1 8 cyl. 11,217 cc 10 PB1 10 cyl. 14,022 cc 12 PB1 12 cyl. 16,826 cc		<table border="1"> <tr> <td></td> <td>Liner/ Sleeve</td> <td></td> </tr> <tr> <td>Length:</td> <td>219.5</td> <td></td> </tr> <tr> <td>Outside Ø:</td> <td>130.0</td> <td></td> </tr> <tr> <td>Flange Ø:</td> <td>141.7</td> <td></td> </tr> <tr> <td>Flange depth:</td> <td>10.0 +1.2</td> <td></td> </tr> </table>		Liner/ Sleeve		Length:	219.5		Outside Ø:	130.0		Flange Ø:	141.7		Flange depth:	10.0 +1.2		<table border="1"> <tr> <td></td> <td>Piston</td> <td></td> </tr> <tr> <td>Length:</td> <td>104.0</td> <td></td> </tr> <tr> <td>Comp. height:</td> <td>67.8 -23.4</td> <td></td> </tr> </table>		Piston		Length:	104.0		Comp. height:	67.8 -23.4			<table border="1"> <tr> <td></td> <td>Rings</td> <td></td> </tr> <tr> <td>Top:</td> <td>3.0</td> <td rowspan="3">Ø : 38.0 Length: 78.0</td> </tr> <tr> <td>2nd:</td> <td>2.5</td> </tr> <tr> <td>oil:</td> <td>4.0</td> </tr> </table>		Rings		Top:	3.0	Ø : 38.0 Length: 78.0	2nd:	2.5	oil:	4.0	
			Liner/ Sleeve																																					
		Length:	219.5																																					
Outside Ø:	130.0																																							
Flange Ø:	141.7																																							
Flange depth:	10.0 +1.2																																							
	Piston																																							
Length:	104.0																																							
Comp. height:	67.8 -23.4																																							
	Rings																																							
Top:	3.0	Ø : 38.0 Length: 78.0																																						
2nd:	2.5																																							
oil:	4.0																																							
Reference no.:	Reference no.:	Reference no.:	Reference no.:	Reference no.:	Reference no.:																																			
1-11261-063-0	2 cyls pack	2 cyls pack	O-Ring: 1 cyl pack	1-12111-156-1 1-12111-217-1 1 cyl pack	1-12121-043-0 1-12181-058-0 1-12181-061-0 1-12181-069-0 1 cyl pack	1-12251-011-0 2 cyls pack																																		
NM-Motorservice Article no./ Artikelnummer/ Modelo número/ статья номер	NM-Motorservice Article no.:	NM-Motorservice Article no.:	NM-Motorservice Article no.:	NM-Motorservice Article no.:	NM-Motorservice Article no.:	NM-Motorservice Article no.:																																		
	LBS 19400 FA LBS 19400-1 FA LBS 19400-2 FA	LB 19400 F LB 19400 -1 F LB 19400 -2 F	KBS 19400 A	KB 19400 A	KR 19400	PB 19400																																		

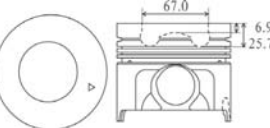

ENGINE TYPE Motortyp/ tipo de motor/ тип двигателя	LINER KIT Liner Kit/ camisas de los cilindros/ Лайнер комплект	CYL. LINER Zylinderlaufbuchse/ camisas de los cilindros/ втулка цилиндра	PISTON + RINGS Kolben + Ringe/ Pistón + Anillos/ поршень и кольца	PISTON SET Kolben Set/ Pistón Set/ поршневой	RINGS SET Ring Set/ Anillos Set/ кольца	PIN Pin/ Perno/ Пин																																		
PC1 Bore Ø 119.0 mm 8 PC1 8 cyl. 12,011 cc 10 PC1 10 cyl. 15,014 cc 12 PC1 12 cyl. 18,017 cc		<table border="1"> <tr> <td></td> <td>Liner/ Sleeve</td> <td></td> </tr> <tr> <td>Length:</td> <td>219.5</td> <td></td> </tr> <tr> <td>Outside Ø:</td> <td>133.0</td> <td></td> </tr> <tr> <td>Flange Ø:</td> <td>143.7</td> <td></td> </tr> <tr> <td>Flange depth:</td> <td>10.0 +1.0</td> <td></td> </tr> </table>		Liner/ Sleeve		Length:	219.5		Outside Ø:	133.0		Flange Ø:	143.7		Flange depth:	10.0 +1.0		<table border="1"> <tr> <td></td> <td>Piston</td> <td></td> </tr> <tr> <td>Length:</td> <td>104.0</td> <td></td> </tr> <tr> <td>Comp. height:</td> <td>67.7 -23.2</td> <td></td> </tr> </table>		Piston		Length:	104.0		Comp. height:	67.7 -23.2			<table border="1"> <tr> <td></td> <td>Rings</td> <td></td> </tr> <tr> <td>Top:</td> <td>3.0</td> <td rowspan="3">Ø : 38.0 Length: 80.5</td> </tr> <tr> <td>2nd:</td> <td>2.5</td> </tr> <tr> <td>oil:</td> <td>4.0</td> </tr> </table>		Rings		Top:	3.0	Ø : 38.0 Length: 80.5	2nd:	2.5	oil:	4.0	
			Liner/ Sleeve																																					
		Length:	219.5																																					
Outside Ø:	133.0																																							
Flange Ø:	143.7																																							
Flange depth:	10.0 +1.0																																							
	Piston																																							
Length:	104.0																																							
Comp. height:	67.7 -23.2																																							
	Rings																																							
Top:	3.0	Ø : 38.0 Length: 80.5																																						
2nd:	2.5																																							
oil:	4.0																																							
Reference no.:	Reference no.:	Reference no.:	Reference no.:	Reference no.:	Reference no.:																																			
1-11261-143-1	2 cyls pack	2 cyls pack	O-Ring: 1 cyl pack	1-12111-419-2 1 cyl pack	1-12121-047-0 1-12121-048-0 1 cyl pack	1-12251-001-0 2 cyls pack																																		
NM-Motorservice Article no./ Artikelnummer/ Modelo número/ статья номер	NM-Motorservice Article no.:	NM-Motorservice Article no.:	NM-Motorservice Article no.:	NM-Motorservice Article no.:	NM-Motorservice Article no.:	NM-Motorservice Article no.:																																		
	LBS 19450 FA LBS 19450-1 FA LBS 19450-2 FA	LB 19450 F LB 19450 -1 F LB 19450 -2 F	KBS 19450 A	KB 19450 A	KR 19450	PB 19450																																		

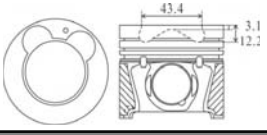

ENGINE TYPE Motortyp/ tipo de motor/ тип двигателя	LINER KIT Liner Kit/ camisas de los cilindros/ Лайнер комплект	CYL. LINER Zylinderlaufbuchse/ camisas de los cilindros/ втулка цилиндра	PISTON + RINGS Kolben + Ringe/ Pistón + Anillos/ поршень и кольца	PISTON SET Kolben Set/ Pistón Set/ поршневой	RINGS SET Ring Set/ Anillos Set/ кольца	PIN Pin/ Perno/ Пин
PC1T TURBO Bore Ø 119.0 mm 8 PC1T 8 cyl. 12,011 cc 10 PC1T 10 cyl. 15,014 cc 12 PC1T 12 cyl. 18,017 cc		Liner/ Sleeve	Piston		Rings	Ø : 38.0 Length: 80.0
		Length: 219.5 Outside Ø: 133.0 Flange Ø: 143.7 Flange depth: 10.0 +1.0	Length: 104.0 Comp. height: 67.7 -23.4		Top: 4.0 2nd: 2.5 oil: 4.0	
	2 cyls pack	2 cyls pack	1 cyl pack	1 cyl pack	1 cyl pack	2 cyls pack
NM-Motorservice Article no./ Artikelnummer/ Modelo número/ статья номер	NM-Motorservice Article no.:	NM-Motorservice Article no.:	NM-Motorservice Article no.:	NM-Motorservice Article no.:	NM-Motorservice Article no.:	NM-Motorservice Article no.:
	LBS 45200 FA LBS 45200-1 FA LBS 45200-2 FA	LB 45200 F LB 45200 -1 F LB 45200 -2 F	KBS 45200 A	KB 45200 A	KR 45200	PB 45200



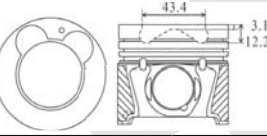

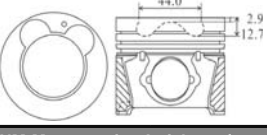

ENGINE TYPE Motortyp/ tipo de motor/ тип двигателя	LINER KIT Liner Kit/ camisas de los cilindros/ Лайнер комплект	CYL. LINER Zylinderlaufbuchse/ camisas de los cilindros/ втулка цилиндра	PISTON + RINGS Kolben + Ringe/ Pistón + Anillos/ поршень и кольца	PISTON SET Kolben Set/ Pistón Set/ поршневой	RINGS SET Ring Set/ Anillos Set/ кольца	PIN Pin/ Perno/ Пин
PD1 Bore Ø 119.0 mm 8 PD1 8 cyl. 13,741 cc 10 PD1 10 cyl. 16,683 cc 12 PD1 12 cyl. 20,019 cc		Liner/ Sleeve	Piston		Rings	Ø : 43.0 Length: 80.0
		Length: 234.0 Outside Ø: 132.95 Flange Ø: 143.6 Flange depth: 10.1	Length: 106.6 Comp. height: 67.6 -15.2 -25.0		Top: 4.0 2nd: 2.5 oil: 4.0	
	2 cyls pack	2 cyls pack	1 cyl pack	1 cyl pack	1 cyl pack	2 cyls pack
NM-Motorservice Article no./ Artikelnummer/ Modelo número/ статья номер	NM-Motorservice Article no.:	NM-Motorservice Article no.:	NM-Motorservice Article no.:	NM-Motorservice Article no.:	NM-Motorservice Article no.:	NM-Motorservice Article no.:
	LBS 19550 FA LBS 19550-1 FA LBS 19550-2 FA	LB 19550 F LB 19550 -1 F LB 19550 -2 F (Water jacket chromed)	KBS 19550 A	KB 19550 A	KR 19550	PB 19550

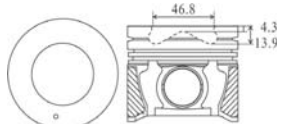

ENGINE TYPE Motortyp/ tipo de motor/ тип двигателя	LINER KIT Liner Kit/ camisas de los cilindros/ Лайнер комплект	CYL. LINER Zylinderlaufbuchse/ camisas de los cilindros/ втулка цилиндра	PISTON + RINGS Kolben + Ringe/ Pistón + Anillos/ поршень и кольца	PISTON SET Kolben Set/ Pistón Set/ поршневой	RINGS SET Ring Set/ Anillos Set/ кольца	PIN Pin/ Perno/ Пин
PE1 Bore Ø 127.0 mm 8 PE1 8 cyl. 15,201 cc 10 PE1 10 cyl. 19,001 cc 12 PE1 12 cyl. 22,801 cc		Liner/ Sleeve	Piston	Alfin and with oil gallery	Rings	Ø : 43.0 Length: 79.7
		Length: 233.0 Outside Ø: 130.5 Flange Ø: 136.5 Flange depth: 6.0	Length: 106.6 Comp. height: 67.7 -6.9 -25.7		Top: 3.8 2nd: 3.0 3rd: 3.0 oil: 4.0	
	2 cyls pack	2 cyls pack	1 cyl pack	1 cyl pack	1 cyl pack	2 cyls pack
NM-Motorservice Article no./ Artikelnummer/ Modelo número/ статья номер	NM-Motorservice Article no.:	NM-Motorservice Article no.:	NM-Motorservice Article no.:	NM-Motorservice Article no.:	NM-Motorservice Article no.:	NM-Motorservice Article no.:
	LBS 19600 FB LBS 19600-1 FB LBS 19600-2 FB	LB 19600 F LB 19600 -1 F LB 19600 -2 F	KBS 19600 B	KB 19600 B	KR 19600	PB 19600

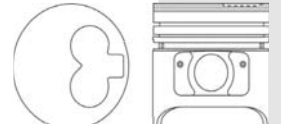

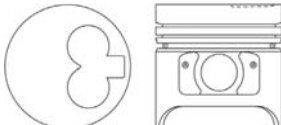
ENGINE TYPE Motortyp/ tipo de motor/ тип двигателя	LINER KIT Liner Kit/ camisas de los cilindros/ Лайнер комплект	CYL. LINER Zylinderlaufbuchse/ camisas de los cilindros/ втулка цилиндра		PISTON + RINGS Kolben + Ringe/ Pistón + Anillos/ поршень и кольца	PISTON SET Kolben Set/ Pistón Set/ поршневой	RINGS SET Ring Set/ Anillos Set/ кольца	PIN Pin/ Perno/ Пин
PICANTO 1.1 TDi 2004-2006 1,119 cc 3 cyl 75.0 mm Bore Ø		Flanged	No flange	Piston	Alfin and with oil gallery skirt MOS2 treated	Rings	Ø : 28.0 Length: 60.0
		Length: 142.0 Outside Ø: 78.0 Flange Ø: 80.0 Flange depth: 4.0	142.0 78.0				
		Reference no.:		Reference no.:	Reference no.:	Reference no.:	Reference no.:
NM-Motorservice Article no./ Artikelnummer/ Modelo пункта/ статья номер	NM-Motorservice Article no.:	NM-Motorservice Article no.:		NM-Motorservice Article no.:	NM-Motorservice Article no.:	NM-Motorservice Article no.:	NM-Motorservice Article no.:
	LBS 40750 PB LBS 40750 SB	LB 40750 P LB 40750 S		KBS 40750 B	KB 40750 B	KR 40750	PB 40750

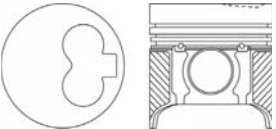

ENGINE TYPE Motortyp/ tipo de motor/ тип двигателя	LINER KIT Liner Kit/ camisas de los cilindros/ Лайнер комплект	CYL. LINER Zylinderlaufbuchse/ camisas de los cilindros/ втулка цилиндра		PISTON + RINGS Kolben + Ringe/ Pistón + Anillos/ поршень и кольца	PISTON SET Kolben Set/ Pistón Set/ поршневой	RINGS SET Ring Set/ Anillos Set/ кольца	PIN Pin/ Perno/ Пин
CERATO 1.5 TDi RIO 1.5 CRDi 2006-2008 1,493 cc 4 cyl 75.0 mm Bore Ø		Flanged	No flange	Piston	Alfin and with oil gallery skirt MOS2 treated	Rings	Ø : 28.0 Length: 60.0
		Length: 142.0 Outside Ø: 78.0 Flange Ø: 80.0 Flange depth: 4.0	142.0 78.0				
		Reference no.:		Reference no.:	Reference no.:	Reference no.:	Reference no.:
NM-Motorservice Article no./ Artikelnummer/ Modelo пункта/ статья номер	NM-Motorservice Article no.:	NM-Motorservice Article no.:		NM-Motorservice Article no.:	NM-Motorservice Article no.:	NM-Motorservice Article no.:	NM-Motorservice Article no.:
	LBS 40800 PB LBS 40800 SB	LB 40800 P LB 40800 S		KBS 40800 B	KB 40800 B	KR 40800	PB 40800

ENGINE TYPE Motortyp/ tipo de motor/ тип двигателя	LINER KIT Liner Kit/ camisas de los cilindros/ Лайнер комплект	CYL. LINER Zylinderlaufbuchse/ camisas de los cilindros/ втулка цилиндра		PISTON + RINGS Kolben + Ringe/ Pistón + Anillos/ поршень и кольца	PISTON SET Kolben Set/ Pistón Set/ поршневой	RINGS SET Ring Set/ Anillos Set/ кольца	PIN Pin/ Perno/ Пин
CEE'D 1.6 TCi CERATO 1.6 TDi 2006-2008 1,582 cc 4 cyl 77.2 mm Bore Ø		Flanged	No flange	Piston	Alfin and with oil gallery skirt MOS2 treated	Rings	Ø : 28.0 Length: 62.0
		Length: 142.0 Outside Ø: 78.0 Flange Ø: 80.0 Flange depth: 4.0	142.0 78.0				
		Reference no.:		Reference no.:	Reference no.:	Reference no.:	Reference no.:
NM-Motorservice Article no./ Artikelnummer/ Modelo пункта/ статья номер	NM-Motorservice Article no.:	NM-Motorservice Article no.:		NM-Motorservice Article no.:	NM-Motorservice Article no.:	NM-Motorservice Article no.:	NM-Motorservice Article no.:
	LBS 40850 PB LBS 40850 SB	LB 40850 P LB 40850 S		KBS 40850 B	KB 40850 B	KR 40850	PB 40850

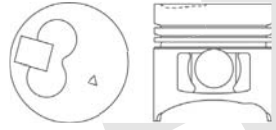
ENGINE TYPE Motortyp/ tipo de motor/ тип двигателя	LINER KIT Liner Kit/ camisas de los cilindros/ Лайнер комплект	CYL. LINER Zylinderlaufbuchse/ camisas de los cilindros/ втулка цилиндра	PISTON + RINGS Kolben + Ringe/ Pistón + Anillos/ поршень и кольца	PISTON SET Kolben Set/ Pistón Set/ поршневой	RINGS SET Ring Set/ Anillos Set/ кольца	PIN Pin/ Perno/ Пин																																										
CARENS CRDi NEW SPORTAGE Tci 2002-2006 1,991 cc 4 cyl 83.0 mm Bore Ø		<table border="1"> <tr> <td></td> <td>Flanged</td> <td>No flange</td> <td></td> </tr> <tr> <td>Length:</td> <td>153.5</td> <td>153.5</td> <td></td> </tr> <tr> <td>Outside Ø:</td> <td>86.0</td> <td>86.0</td> <td></td> </tr> <tr> <td>Flange Ø:</td> <td>89.0</td> <td></td> <td></td> </tr> <tr> <td>Flange depth:</td> <td>4.8</td> <td></td> <td></td> </tr> </table>		Flanged	No flange		Length:	153.5	153.5		Outside Ø:	86.0	86.0		Flange Ø:	89.0			Flange depth:	4.8			<table border="1"> <tr> <td></td> <td>Piston</td> </tr> <tr> <td>Length:</td> <td>72.3</td> </tr> <tr> <td>Comp. height:</td> <td>46.3</td> </tr> <tr> <td></td> <td>-4.3</td> </tr> <tr> <td></td> <td>-13.9</td> </tr> </table>		Piston	Length:	72.3	Comp. height:	46.3		-4.3		-13.9	Alfin skirt MOS2 treated pin bushing inserted	<table border="1"> <tr> <td></td> <td>Rings</td> </tr> <tr> <td>Top:</td> <td>2.0</td> </tr> <tr> <td>2nd:</td> <td>2.0</td> </tr> <tr> <td>oil:</td> <td>3.0</td> </tr> </table>		Rings	Top:	2.0	2nd:	2.0	oil:	3.0	<table border="1"> <tr> <td>Ø:</td> <td>28.0</td> </tr> <tr> <td>Length:</td> <td>65.5</td> </tr> </table>	Ø:	28.0	Length:	65.5
			Flanged	No flange																																												
		Length:	153.5	153.5																																												
Outside Ø:	86.0	86.0																																														
Flange Ø:	89.0																																															
Flange depth:	4.8																																															
	Piston																																															
Length:	72.3																																															
Comp. height:	46.3																																															
	-4.3																																															
	-13.9																																															
	Rings																																															
Top:	2.0																																															
2nd:	2.0																																															
oil:	3.0																																															
Ø:	28.0																																															
Length:	65.5																																															
	Reference no.:	Reference no.:	Reference no.:	Reference no.:	Reference no.:																																											
NM-Motorservice Article no./ Artikelnummer/ Modelo número/ статья номер	NM-Motorservice Article no.:	NM-Motorservice Article no.:	NM-Motorservice Article no.:	NM-Motorservice Article no.:	NM-Motorservice Article no.:	NM-Motorservice Article no.:																																										
	LBS 40900 PA LBS 40900 SA	LB 40900 P LB 40900 S	KBS 40900 A	KB 40900 A	KR 40900	PB 40900																																										
NB-1 B2200 NEW BESTA 2,184 cc 4 cyl 86.0 mm Bore Ø		<table border="1"> <tr> <td></td> <td>Liner/ Sleeve</td> <td></td> </tr> <tr> <td>Length:</td> <td>163.0</td> <td></td> </tr> <tr> <td>Outside Ø:</td> <td>89.0</td> <td></td> </tr> <tr> <td>Flange Ø:</td> <td>94.0</td> <td></td> </tr> <tr> <td>Flange depth:</td> <td>2.8</td> <td></td> </tr> </table>		Liner/ Sleeve		Length:	163.0		Outside Ø:	89.0		Flange Ø:	94.0		Flange depth:	2.8		<table border="1"> <tr> <td></td> <td>Piston</td> </tr> <tr> <td>Length:</td> <td>86.3</td> </tr> <tr> <td>Comp. height:</td> <td>47.3</td> </tr> <tr> <td></td> <td>-1.6</td> </tr> </table>		Piston	Length:	86.3	Comp. height:	47.3		-1.6		<table border="1"> <tr> <td></td> <td>Rings</td> </tr> <tr> <td>Top:</td> <td>2.0</td> </tr> <tr> <td>2nd:</td> <td>2.0</td> </tr> <tr> <td>oil:</td> <td>4.0</td> </tr> </table>		Rings	Top:	2.0	2nd:	2.0	oil:	4.0	<table border="1"> <tr> <td>Ø:</td> <td>25.0</td> </tr> <tr> <td>Length:</td> <td>68.5</td> </tr> </table>	Ø:	25.0	Length:	68.5							
			Liner/ Sleeve																																													
		Length:	163.0																																													
Outside Ø:	89.0																																															
Flange Ø:	94.0																																															
Flange depth:	2.8																																															
	Piston																																															
Length:	86.3																																															
Comp. height:	47.3																																															
	-1.6																																															
	Rings																																															
Top:	2.0																																															
2nd:	2.0																																															
oil:	4.0																																															
Ø:	25.0																																															
Length:	68.5																																															
	Reference no.:	Reference no.:	Reference no.:	Reference no.:	Reference no.:																																											
NM-Motorservice Article no./ Artikelnummer/ Modelo número/ статья номер	NM-Motorservice Article no.:	NM-Motorservice Article no.:	NM-Motorservice Article no.:	NM-Motorservice Article no.:	NM-Motorservice Article no.:	NM-Motorservice Article no.:																																										
	LBS 40950 FA LBS 40950 SA	LB 40950 F LB 40950 S	KBS 40950 A	KB 40950 A	KR 40950	PB 40950																																										
HW 2,184 cc 4 cyl 86.0 mm Bore Ø		<table border="1"> <tr> <td></td> <td>Liner/ Sleeve</td> <td></td> </tr> <tr> <td>Length:</td> <td>163.0</td> <td></td> </tr> <tr> <td>Outside Ø:</td> <td>89.0</td> <td></td> </tr> <tr> <td>Flange Ø:</td> <td>94.0</td> <td></td> </tr> <tr> <td>Flange depth:</td> <td>2.8</td> <td></td> </tr> </table>		Liner/ Sleeve		Length:	163.0		Outside Ø:	89.0		Flange Ø:	94.0		Flange depth:	2.8		<table border="1"> <tr> <td></td> <td>Piston</td> </tr> <tr> <td>Length:</td> <td>86.3</td> </tr> <tr> <td>Comp. height:</td> <td>47.3</td> </tr> <tr> <td></td> <td>-1.6</td> </tr> </table>		Piston	Length:	86.3	Comp. height:	47.3		-1.6		<table border="1"> <tr> <td></td> <td>Rings</td> </tr> <tr> <td>Top:</td> <td>2.0</td> </tr> <tr> <td>2nd:</td> <td>2.0</td> </tr> <tr> <td>oil:</td> <td>4.0</td> </tr> </table>		Rings	Top:	2.0	2nd:	2.0	oil:	4.0	<table border="1"> <tr> <td>Ø:</td> <td>25.0</td> </tr> <tr> <td>Length:</td> <td>68.0</td> </tr> </table>	Ø:	25.0	Length:	68.0							
			Liner/ Sleeve																																													
		Length:	163.0																																													
Outside Ø:	89.0																																															
Flange Ø:	94.0																																															
Flange depth:	2.8																																															
	Piston																																															
Length:	86.3																																															
Comp. height:	47.3																																															
	-1.6																																															
	Rings																																															
Top:	2.0																																															
2nd:	2.0																																															
oil:	4.0																																															
Ø:	25.0																																															
Length:	68.0																																															
	Reference no.:	Reference no.:	Reference no.:	Reference no.:	Reference no.:																																											
NM-Motorservice Article no./ Artikelnummer/ Modelo número/ статья номер	NM-Motorservice Article no.:	NM-Motorservice Article no.:	NM-Motorservice Article no.:	NM-Motorservice Article no.:	NM-Motorservice Article no.:	NM-Motorservice Article no.:																																										
	LBS 41000 FA LBS 41000 SA	LB 41000 F LB 41000 S	KBS 41000 A	KB 41000 A	KR 41000	PB 41000																																										

ENGINE TYPE Motortyp/ tipo de motor/ тип двигателя	LINER KIT Liner Kit/ camisas de los cilindros/ Лайнер комплект	CYL. LINER Zylinderlaufbuchse/ camisas de los cilindros/ втулка цилиндра	PISTON + RINGS Kolben + Ringe/ Pistón + Anillos/ поршень и кольца		PISTON SET Kolben Set/ Pistón Set/ поршневой	RINGS SET Ring Set/ Anillos Set/ кольца	PIN Pin/ Perno/ Пин	
NB-7 RF-TCi SPORTAGE TURBO 1,998 cc 4 cyl 86.0 mm Bore Ø		Liner/ Sleeve	Piston		Alfin and with oil gallery skirt MOS2 treated	Rings		Ø : Length:
			Length: Outside Ø: Flange Ø: Flange depth:	163.0 89.0 94.0 2.8		Length: Comp. height:	86.2 47.2 -1.2 -3.1	
		Reference no.:	Reference no.:	Reference no.:	Reference no.:	Reference no.:	Reference no.:	
				OK054-11-102 OK0Y1-11-SAO OK0Y1-11-SAX OK0Y1-11-SBZ	K7Y1-11-SCO OK054-11-SCO OK7Y1-11-SCO OK0Y1-11-SDX OK0Y1-11-SDZ			
NM-Motorservice Article no./ Artikelnummer/ Modelo número/ статья номер	NM-Motorservice Article no.:	NM-Motorservice Article no.:	NM-Motorservice Article no.:	NM-Motorservice Article no.:	NM-Motorservice Article no.:	NM-Motorservice Article no.:	NM-Motorservice Article no.:	
	LBS 41050 FB LBS 41050 SB	LB 41050 F LB 41050 S	KBS 41050 B	KB 41050 B	KR 41050	PB 41050		

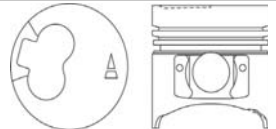

ENGINE TYPE Motortyp/ tipo de motor/ тип двигателя	LINER KIT Liner Kit/ camisas de los cilindros/ Лайнер комплект	CYL. LINER Zylinderlaufbuchse/ camisas de los cilindros/ втулка цилиндра	PISTON + RINGS Kolben + Ringe/ Pistón + Anillos/ поршень и кольца		PISTON SET Kolben Set/ Pistón Set/ поршневой	RINGS SET Ring Set/ Anillos Set/ кольца	PIN Pin/ Perno/ Пин		
K2500 (L/R) PREGIO 2,476 cc 4 cyl 91.1 mm Bore Ø		Flanged	No flange	Piston		Alfin and with oil gallery	Rings		Ø : Length:
			Length: Outside Ø: Flange Ø: Flange depth:	165.0 94.2 98.1 2.0	165.0 94.2		Length: Comp. height:	88.7 48.7 -1.2 -2.7	
		Reference no.:	Reference no.:	Reference no.:	Reference no.:	Reference no.:	Reference no.:		
					(L/R)				
NM-Motorservice Article no./ Artikelnummer/ Modelo número/ статья номер	NM-Motorservice Article no.:	NM-Motorservice Article no.:	NM-Motorservice Article no.:	NM-Motorservice Article no.:	NM-Motorservice Article no.:	NM-Motorservice Article no.:	NM-Motorservice Article no.:		
	LBS 41100 PB LBS 41100 SB	LB 41100 P LB 41100 S	KBS 41100 B	KB 41100 B	KR 41100	PB 41100			



ENGINE TYPE Motortyp/ tipo de motor/ тип двигателя	LINER KIT Liner Kit/ camisas de los cilindros/ Лайнер комплект	CYL. LINER Zylinderlaufbuchse/ camisas de los cilindros/ втулка цилиндра	PISTON + RINGS Kolben + Ringe/ Pistón + Anillos/ поршень и кольца		PISTON SET Kolben Set/ Pistón Set/ поршневой	RINGS SET Ring Set/ Anillos Set/ кольца	PIN Pin/ Perno/ Пин		
K2500 TCi (L/R) PREGIO 2,476 cc 4 cyl 91.1 mm Bore Ø		Flanged	No flange	Piston		Alfin and with oil gallery	Rings		Ø : Length:
			Length: Outside Ø: Flange Ø: Flange depth:	165.0 94.2 98.1 2.0	165.0 94.2		Length: Comp. height:	88.7 48.7 -2.3	
		Reference no.:	Reference no.:	Reference no.:	Reference no.:	Reference no.:	Reference no.:		
					(L/R)				
NM-Motorservice Article no./ Artikelnummer/ Modelo número/ статья номер	NM-Motorservice Article no.:	NM-Motorservice Article no.:	NM-Motorservice Article no.:	NM-Motorservice Article no.:	NM-Motorservice Article no.:	NM-Motorservice Article no.:	NM-Motorservice Article no.:		
	LBS 41150 PB LBS 41150 SB	LB 41150 P LB 41150 S	KBS 41150 B	KB 41150 B	KR 41150	PB 41150			



ENGINE TYPE Motortyp/ tipo de motor/ тип двигателя	LINER KIT Liner Kit/ camisas de los cilindros/ Лайнер комплект	CYL. LINER Zylinderlaufbuchse/ camisas de los cilindros/ втулка цилиндра	PISTON + RINGS Kolben + Ringe/ Pistón + Anillos/ поршень и кольца	PISTON SET Kolben Set/ Pistón Set/ поршневой	RINGS SET Ring Set/ Anillos Set/ кольца	PIN Pin/ Perno/ Пин																																			
K2500 (L/R) PREGIO FP 2,476 cc 4 cyl 91.1 mm Bore Ø		<table border="1"> <tr> <td></td> <td>Flanged</td> <td>No flange</td> </tr> <tr> <td>Length:</td> <td>165.0</td> <td>165.0</td> </tr> <tr> <td>Outside Ø:</td> <td>94.2</td> <td>94.2</td> </tr> <tr> <td>Flange Ø:</td> <td>98.1</td> <td></td> </tr> <tr> <td>Flange depth:</td> <td>2.0</td> <td></td> </tr> </table>		Flanged	No flange	Length:	165.0	165.0	Outside Ø:	94.2	94.2	Flange Ø:	98.1		Flange depth:	2.0		<table border="1"> <tr> <td colspan="2">Piston</td> </tr> <tr> <td>Length:</td> <td>88.7</td> </tr> <tr> <td>Comp. height:</td> <td>48.7</td> </tr> <tr> <td></td> <td>-3.0</td> </tr> </table>	Piston		Length:	88.7	Comp. height:	48.7		-3.0	Alfin and with oil gallery	<table border="1"> <tr> <td colspan="2">Rings</td> </tr> <tr> <td>Top:</td> <td>2.5</td> </tr> <tr> <td>2nd:</td> <td>2.0</td> </tr> <tr> <td>oil:</td> <td>4.0</td> </tr> <tr> <td>Ø:</td> <td>29.0</td> </tr> <tr> <td>Length:</td> <td>75.0</td> </tr> </table>	Rings		Top:	2.5	2nd:	2.0	oil:	4.0	Ø:	29.0	Length:	75.0	
			Flanged	No flange																																					
Length:	165.0	165.0																																							
Outside Ø:	94.2	94.2																																							
Flange Ø:	98.1																																								
Flange depth:	2.0																																								
Piston																																									
Length:	88.7																																								
Comp. height:	48.7																																								
	-3.0																																								
Rings																																									
Top:	2.5																																								
2nd:	2.0																																								
oil:	4.0																																								
Ø:	29.0																																								
Length:	75.0																																								
		Reference no.:	Reference no.:	Reference no.:	Reference no.:	Reference no.:																																			
				(L/R)																																					
NM-Motorservice Article no./ Artikelnummer/ Modelo número/ статья номер	NM-Motorservice Article no.:	NM-Motorservice Article no.:	NM-Motorservice Article no.:	NM-Motorservice Article no.:	NM-Motorservice Article no.:	NM-Motorservice Article no.:																																			
	LBS 41200 PB LBS 41200 SB	LB 41200 P LB 41200 S	KBS 41200 B	KB 41200 B	KR 41200	PB 41200																																			

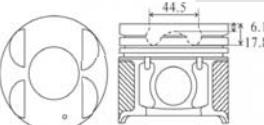

ENGINE TYPE Motortyp/ tipo de motor/ тип двигателя	LINER KIT Liner Kit/ camisas de los cilindros/ Лайнер комплект	CYL. LINER Zylinderlaufbuchse/ camisas de los cilindros/ втулка цилиндра	PISTON + RINGS Kolben + Ringe/ Pistón + Anillos/ поршень и кольца	PISTON SET Kolben Set/ Pistón Set/ поршневой	RINGS SET Ring Set/ Anillos Set/ кольца	PIN Pin/ Perno/ Пин																																								
SF K2400 2,417 cc 4 cyl 92.0 mm Bore Ø		<table border="1"> <tr> <td></td> <td>Liner/ Sleeve</td> <td></td> </tr> <tr> <td>Length:</td> <td>165.0</td> <td></td> </tr> <tr> <td>Outside Ø:</td> <td>96.9</td> <td></td> </tr> <tr> <td>Flange Ø:</td> <td>100.9</td> <td></td> </tr> <tr> <td>Flange depth:</td> <td>3.86</td> <td></td> </tr> <tr> <td></td> <td>+0.8</td> <td></td> </tr> </table>		Liner/ Sleeve		Length:	165.0		Outside Ø:	96.9		Flange Ø:	100.9		Flange depth:	3.86			+0.8		<table border="1"> <tr> <td colspan="2">Piston</td> </tr> <tr> <td>Length:</td> <td>94.6</td> </tr> <tr> <td>Comp. height:</td> <td>50.6</td> </tr> <tr> <td></td> <td>-1.9</td> </tr> <tr> <td></td> <td>-4.6</td> </tr> </table>	Piston		Length:	94.6	Comp. height:	50.6		-1.9		-4.6		<table border="1"> <tr> <td colspan="2">Rings</td> </tr> <tr> <td>Top:</td> <td>2.4</td> </tr> <tr> <td>2nd:</td> <td>2.4</td> </tr> <tr> <td>oil:</td> <td>4.0</td> </tr> <tr> <td>Ø:</td> <td>28.0</td> </tr> <tr> <td>Length:</td> <td>75.0</td> </tr> </table>	Rings		Top:	2.4	2nd:	2.4	oil:	4.0	Ø:	28.0	Length:	75.0	
			Liner/ Sleeve																																											
Length:	165.0																																													
Outside Ø:	96.9																																													
Flange Ø:	100.9																																													
Flange depth:	3.86																																													
	+0.8																																													
Piston																																														
Length:	94.6																																													
Comp. height:	50.6																																													
	-1.9																																													
	-4.6																																													
Rings																																														
Top:	2.4																																													
2nd:	2.4																																													
oil:	4.0																																													
Ø:	28.0																																													
Length:	75.0																																													
		Reference no.:	Reference no.:	Reference no.:	Reference no.:	Reference no.:																																								
		1456-10-311 1456-10-311B K456-10-311 K756-10-311 OK756-10-311 OK756-10-311A		K768-11-102 K720-11-SAO OK720-11-SAO OK720-11-SBX OK720-11-SBZ	K756-23-206 K720-11-SCO OK720-11-SCO OK720-11-SCD OK720-11-SCX OK720-11-SCY OK720-11-SCZ																																									
NM-Motorservice Article no./ Artikelnummer/ Modelo número/ статья номер	NM-Motorservice Article no.:	NM-Motorservice Article no.:	NM-Motorservice Article no.:	NM-Motorservice Article no.:	NM-Motorservice Article no.:	NM-Motorservice Article no.:																																								
	LBS 41250 FA LBS 41250 SA	LB 41250 F LB 41250 S	KBS 41250	KB 41250	KR 41250	PB 41250																																								

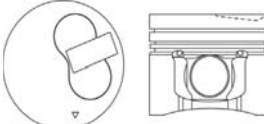

ENGINE TYPE Motortyp/ tipo de motor/ тип двигателя	LINER KIT Liner Kit/ camisas de los cilindros/ Лайнер комплект	CYL. LINER Zylinderlaufbuchse/ camisas de los cilindros/ втулка цилиндра	PISTON + RINGS Kolben + Ringe/ Pistón + Anillos/ поршень и кольца	PISTON SET Kolben Set/ Pistón Set/ поршневой	RINGS SET Ring Set/ Anillos Set/ кольца	PIN Pin/ Perno/ Пин																																								
RFA CN HI-BESTA 2,662 cc 4 cyl 93.0 mm Bore Ø		<table border="1"> <tr> <td></td> <td>Liner/ Sleeve</td> <td></td> </tr> <tr> <td>Length:</td> <td>167.5</td> <td></td> </tr> <tr> <td>Outside Ø:</td> <td>96.8</td> <td></td> </tr> <tr> <td>Flange Ø:</td> <td>102.2</td> <td></td> </tr> <tr> <td>Flange depth:</td> <td>2.5</td> <td></td> </tr> <tr> <td></td> <td>+0.5</td> <td></td> </tr> </table>		Liner/ Sleeve		Length:	167.5		Outside Ø:	96.8		Flange Ø:	102.2		Flange depth:	2.5			+0.5		<table border="1"> <tr> <td colspan="2">Piston</td> </tr> <tr> <td>Length:</td> <td>85.2</td> </tr> <tr> <td>Comp. height:</td> <td>48.2</td> </tr> <tr> <td></td> <td>-1.8</td> </tr> <tr> <td></td> <td>-2.8</td> </tr> </table>	Piston		Length:	85.2	Comp. height:	48.2		-1.8		-2.8	Alfin and with oil gallery	<table border="1"> <tr> <td colspan="2">Rings</td> </tr> <tr> <td>Top:</td> <td>2.0</td> </tr> <tr> <td>2nd:</td> <td>2.0</td> </tr> <tr> <td>oil:</td> <td>3.0</td> </tr> <tr> <td>Ø:</td> <td>30.0</td> </tr> <tr> <td>Length:</td> <td>76.0</td> </tr> </table>	Rings		Top:	2.0	2nd:	2.0	oil:	3.0	Ø:	30.0	Length:	76.0	
			Liner/ Sleeve																																											
Length:	167.5																																													
Outside Ø:	96.8																																													
Flange Ø:	102.2																																													
Flange depth:	2.5																																													
	+0.5																																													
Piston																																														
Length:	85.2																																													
Comp. height:	48.2																																													
	-1.8																																													
	-2.8																																													
Rings																																														
Top:	2.0																																													
2nd:	2.0																																													
oil:	3.0																																													
Ø:	30.0																																													
Length:	76.0																																													
		Reference no.:	Reference no.:	Reference no.:	Reference no.:	Reference no.:																																								
		OVN01-10-311 VN01-10-311		OVNY1-11-SAO VNY1-11-SAO	OVNY1-11-SCO VNY1-11-SCO	OVNY1-11-213																																								
NM-Motorservice Article no./ Artikelnummer/ Modelo número/ статья номер	NM-Motorservice Article no.:	NM-Motorservice Article no.:	NM-Motorservice Article no.:	NM-Motorservice Article no.:	NM-Motorservice Article no.:	NM-Motorservice Article no.:																																								
	LBS 41300 FB LBS 41300 SB	LB 41300 F (phosphated) LB 41300 S	KBS 41300 B	KB 41300 B	KR 41300	PB 41300																																								

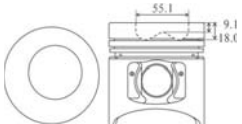

ENGINE TYPE Motor/typo/ tipo de motor/ тип двигателя	LINER KIT Liner Kit/ camisas de los cilindros/ Лайнер комплект	CYL. LINER Zylinderlaufbuchse/ camisas de los cilindros/ втулка цилиндра	PISTON + RINGS Kolben + Ringe/ Pistón + Anillos/ поршень и кольца	PISTON SET Kolben Set/ Pistón Set/ поршневой	RINGS SET Ring Set/ Anillos Set/ кольца	PIN Pin/ Perno/ Пин	
J2 JS K2700 FRONTIER-PREGIO 2.7 2,665 cc 4 cyl 94.5 mm Bore Ø		Liner/ Sleeve	Piston		Rings		
		Length: Outside Ø: Flange Ø: Flange depth:	166.0 97.47 104.2 3.85 +0.5	Length: Comp. height:	81.7 50.0 -1.9 -3.4	Top: 2nd: oil:	2.0 2.0 3.0
		Reference no.:	Reference no.:	Reference no.:	Reference no.:	Reference no.:	
		K65A-10-311 OK65A-10-311 OK65B-10-311		K6Z1-11-SAO OK6Z1-11-SAO	K6Z1-11-SCO K6Z1-46-SCO OK6Z1-11-SCO	OSE01-11-213	
NM-Motorservice Article no./ Artikelnummer/ Modelo número/ статья номер	NM-Motorservice Article no.:	NM-Motorservice Article no.:	NM-Motorservice Article no.:	NM-Motorservice Article no.:	NM-Motorservice Article no.:	NM-Motorservice Article no.:	
	LBS 41350 FA LBS 41350 SA	LB 41350 F (phosphated) LB 41350 S	KBS 41350 A	KB 41350 A	KR 41350	PB 41350	

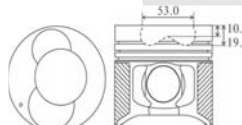

ENGINE TYPE Motor/typo/ tipo de motor/ тип двигателя	LINER KIT Liner Kit/ camisas de los cilindros/ Лайнер комплект	CYL. LINER Zylinderlaufbuchse/ camisas de los cilindros/ втулка цилиндра	PISTON + RINGS Kolben + Ringe/ Pistón + Anillos/ поршень и кольца	PISTON SET Kolben Set/ Pistón Set/ поршневой	RINGS SET Ring Set/ Anillos Set/ кольца	PIN Pin/ Perno/ Пин			
J3 TCi K2900 2,902 cc 2,902 cyl 97.1 mm Bore Ø		Flanged	No flange	Piston		Rings			
		Length: Outside Ø: Flange Ø: Flange depth:	168.0 101.5 106.0 2.5 +0.7	168.0 101.2	Length: Comp. height:	84.0 52.0 -6.1 -17.8	Alfin and with oil gallery skirt MOS2 treated	Top: 2nd: oil:	2.0 2.0 3.0
		Reference no.:	Reference no.:	Reference no.:	Reference no.:	Reference no.:			
		OK551-10-311 OK551-10-311A		OK5Z1-11-SAO	K5Z1-11-SCO OK5Z1-11-SCO				
NM-Motorservice Article no./ Artikelnummer/ Modelo número/ статья номер	NM-Motorservice Article no.:	NM-Motorservice Article no.:	NM-Motorservice Article no.:	NM-Motorservice Article no.:	NM-Motorservice Article no.:	NM-Motorservice Article no.:			
	LBS 41400 FB LBS 41400 PB LBS 41400 SB	LB 41400 F LB 41400 P LB 41400 S	KBS 41400 B	KB 41400 B	KR 41400	PB 41400			

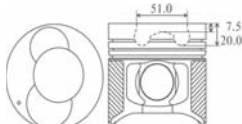

ENGINE TYPE Motor/typo/ tipo de motor/ тип двигателя	LINER KIT Liner Kit/ camisas de los cilindros/ Лайнер комплект	CYL. LINER Zylinderlaufbuchse/ camisas de los cilindros/ втулка цилиндра	PISTON + RINGS Kolben + Ringe/ Pistón + Anillos/ поршень и кольца	PISTON SET Kolben Set/ Pistón Set/ поршневой	RINGS SET Ring Set/ Anillos Set/ кольца	PIN Pin/ Perno/ Пин		
JT PREGIO 3.0 3,000 cc 4 cyl 98.0 mm Bore Ø		Liner/ Sleeve	Piston		Rings			
		Length: Outside Ø: Flange Ø: Flange depth:	166.2 101.5 107.0 2.5 +0.7	Length: Comp. height:	76.1 45.5 -1.4 -4.9	Alfin and with oil gallery skirt MOS2 treated	Top: 2nd: oil:	2.0 2.0 3.0
		Reference no.:	Reference no.:	Reference no.:	Reference no.:	Reference no.:		
		K75A-10-311 OK75A-10-311 OK75A-10-311B OK75B-10-311		KDAJ2-11-SAO K7Z1-11-SAO OK7Z1-11-SAO	K7Z1-11-SCO OK7Z1-11-SCO	OSE01-11-213		
NM-Motorservice Article no./ Artikelnummer/ Modelo número/ статья номер	NM-Motorservice Article no.:	NM-Motorservice Article no.:	NM-Motorservice Article no.:	NM-Motorservice Article no.:	NM-Motorservice Article no.:	NM-Motorservice Article no.:		
	LBS 41450 FB LBS 41450 SB	LB 41450 F (phosphated) LB 41450 S	KBS 41450 B	KB 41450 B	KR 41450	PB 41450		

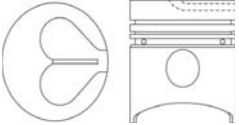

ENGINE TYPE Motortyp/ tipo de motor/ тип двигателя	LINER KIT Liner Kit/ camisas de los cilindros/ Лайнер комплект	CYL. LINER Zylinderlaufbuchse/ camisas de los cilindros/ втулка цилиндра	PISTON + RINGS Kolben + Ringe/ Pistón + Anillos/ поршень и кольца	PISTON SET Kolben Set/ Pistón Set/ поршневой	RINGS SET Ring Set/ Anillos Set/ кольца	PIN Pin/ Perno/ Пин
JD K3500		Liner/ Sleeve	Piston		Rings	Ø : 34.0 Length: 82.0
		Length: 193.5 Outside Ø: 103.5 Flange Ø: 108.0 Flange depth: 2.5 +0.8	Length: 105.0 Comp. height: 58.0 -9.1 -18.0	Top: 2.5 2nd: 2.0 oil: 4.5		
3,455 cc 4 cyl 100.0 mm Bore Ø						
						
NM-Motorservice Article no./ Artikelnummer/ Modelo número/ статья номер	NM-Motorservice Article no.:	NM-Motorservice Article no.:	NM-Motorservice Article no.:	NM-Motorservice Article no.:	NM-Motorservice Article no.:	NM-Motorservice Article no.:
	LBS 44550 FA LBS 44550 SA	LB 44550 F LB 44550 S	KBS 44550 A	KB 44550 A	KR 44550	PB 44550

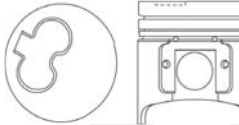

ENGINE TYPE Motortyp/ tipo de motor/ тип двигателя	LINER KIT Liner Kit/ camisas de los cilindros/ Лайнер комплект	CYL. LINER Zylinderlaufbuchse/ camisas de los cilindros/ втулка цилиндра	PISTON + RINGS Kolben + Ringe/ Pistón + Anillos/ поршень и кольца	PISTON SET Kolben Set/ Pistón Set/ поршневой	RINGS SET Ring Set/ Anillos Set/ кольца	PIN Pin/ Perno/ Пин
SH K3600		Liner/ Sleeve	Piston		Rings	Ø : 34.0 Length: 82.0
		Length: 193.5 Outside Ø: 103.5 Flange Ø: 108.0 Flange depth: 2.5 +0.8	Length: 102.0 Comp. height: 56.2 -10.3 -19.2	With oil gallery skirt MOS2 treated		
3,598 cc 4 cyl 100.0 mm Bore Ø						
						
NM-Motorservice Article no./ Artikelnummer/ Modelo número/ статья номер	NM-Motorservice Article no.:	NM-Motorservice Article no.:	NM-Motorservice Article no.:	NM-Motorservice Article no.:	NM-Motorservice Article no.:	NM-Motorservice Article no.:
	LBS 41550 G LBS 41550 G	LB 41550 FG LB 41550 SG	KBS 41550 G	KB 41550 G	KR 41550	PB 41550

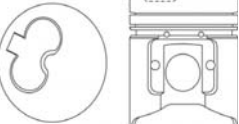

ENGINE TYPE Motortyp/ tipo de motor/ тип двигателя	LINER KIT Liner Kit/ camisas de los cilindros/ Лайнер комплект	CYL. LINER Zylinderlaufbuchse/ camisas de los cilindros/ втулка цилиндра	PISTON + RINGS Kolben + Ringe/ Pistón + Anillos/ поршень и кольца	PISTON SET Kolben Set/ Pistón Set/ поршневой	RINGS SET Ring Set/ Anillos Set/ кольца	PIN Pin/ Perno/ Пин
SH K3600 New		Liner/ Sleeve	Piston		Rings	Ø : 34.0 Length: 82.0
		Length: 193.5 Outside Ø: 103.5 Flange Ø: 108.0 Flange depth: 2.5 +0.8	Length: 102.0 Comp. height: 56.2 -7.55 -20.0	With oil gallery skirt MOS2 treated		
3,598 cc 4 cyl 100.0 mm Bore Ø						
						
NM-Motorservice Article no./ Artikelnummer/ Modelo número/ статья номер	NM-Motorservice Article no.:	NM-Motorservice Article no.:	NM-Motorservice Article no.:	NM-Motorservice Article no.:	NM-Motorservice Article no.:	NM-Motorservice Article no.:
	LBS 41600 FG LBS 41600 SG	LB 41600 F LB 41600 S	KBS 41600 G	KB 41600 G	KR 41600	PB 41600



ENGINE TYPE Motortyp/ tipo de motor/ тип двигателя	LINER KIT Liner Kit/ camisas de los cilindros/ Лайнер комплект	CYL. LINER Zylinderlaufbuchse/ camisas de los cilindros/ втулка цилиндра		PISTON + RINGS Kolben + Ringe/ Pistón + Anillos/ поршень и кольца		PISTON SET Kolben Set/ Pistón Set/ поршневой		RINGS SET Ring Set/ Anillos Set/ кольца		PIN Pin/ Perno/ Пин	
4D94 2,940 cc 4 cyl 94.0 mm Bore Ø			Liner/ Sleeve	Piston				Rings			
		Length: Outside Ø: Flange Ø: Flange depth:	181.0 108.0 117.0 10.0 +1.0	Length: Comp. height:	99.0 55.0 -3.2 -8.5	Top: 2nd: oil:	2.9 2.5 5.0	Ø: Length:	32.0 74.0		
		Reference no.:		Reference no.:		Reference no.:		Reference no.:		Reference no.:	
		6142-22-2211 6144-21-2211		O-Ring: 6142-21-2230		6142-32-2120		6142-32-2020 6142-32-2030		6140-31-3131	
NM-Motorservice Article no./ Artikelnummer/ Modelo número/ статья номер	NM-Motorservice Article no.:	NM-Motorservice Article no.:		NM-Motorservice Article no.:		NM-Motorservice Article no.:		NM-Motorservice Article no.:		NM-Motorservice Article no.:	
	LBS 19650 F LBS 19650 FA	LB 19650 F LB 19650 S		KBS 19650 KBS 19650 A		KB 19650 A KB 19650 A		KR 19650		KR 19650	

ENGINE TYPE Motortyp/ tipo de motor/ тип двигателя	LINER KIT Liner Kit/ camisas de los cilindros/ Лайнер комплект	CYL. LINER Zylinderlaufbuchse/ camisas de los cilindros/ втулка цилиндра		PISTON + RINGS Kolben + Ringe/ Pistón + Anillos/ поршень и кольца		PISTON SET Kolben Set/ Pistón Set/ поршневой		RINGS SET Ring Set/ Anillos Set/ кольца		PIN Pin/ Perno/ Пин	
4D94 2,775 cc 4 cyl 94.0 mm Bore Ø			Liner/ Sleeve	Piston				Rings			
		Length: Outside Ø: Flange Ø: Flange depth:	181.0 108.0 117.0 10.0 +1.0	Length: Comp. height:	99.4 55.4 -2.4 -4.4	Top: 2nd: oil:	2.0 2.0 3.0	Ø: Length:	30.0 72.5		
		Reference no.:		Reference no.:		Reference no.:		Reference no.:		Reference no.:	
		6142-22-2211 6144-21-2211		O-Ring: 6142-21-2230				6209-21-2400		129900-23910	
NM-Motorservice Article no./ Artikelnummer/ Modelo número/ статья номер	NM-Motorservice Article no.:	NM-Motorservice Article no.:		NM-Motorservice Article no.:		NM-Motorservice Article no.:		NM-Motorservice Article no.:		NM-Motorservice Article no.:	
	LBS 19700 FA LBS 19700 SA	LB 19700 F LB 19700 S		KBS 19700 A		KB 19700 A		KR 19700		PB 19700	

ENGINE TYPE Motortyp/ tipo de motor/ тип двигателя	LINER KIT Liner Kit/ camisas de los cilindros/ Лайнер комплект	CYL. LINER Zylinderlaufbuchse/ camisas de los cilindros/ втулка цилиндра		PISTON + RINGS Kolben + Ringe/ Pistón + Anillos/ поршень и кольца		PISTON SET Kolben Set/ Pistón Set/ поршневой		RINGS SET Ring Set/ Anillos Set/ кольца		PIN Pin/ Perno/ Пин	
4D94E 2,775 cc 4 cyl 94.0 mm Bore Ø			Liner/ Sleeve	Piston				Rings			
		Length: Outside Ø: Flange Ø: Flange depth:	181.0 108.0 117.0 10.0 +1.0	Length: Comp. height:	103.8 59.7 -3.4	Top: 2nd: oil:	2.0 2.0 3.0	Ø: Length:	30.0 74.0		
		Reference no.:		Reference no.:		Reference no.:		Reference no.:		Reference no.:	
		6142-22-2211 6144-21-2211		O-Ring: 6142-21-2230				6209-21-2400		129900-23910	
NM-Motorservice Article no./ Artikelnummer/ Modelo número/ статья номер	NM-Motorservice Article no.:	NM-Motorservice Article no.:		NM-Motorservice Article no.:		NM-Motorservice Article no.:		NM-Motorservice Article no.:		NM-Motorservice Article no.:	
	LBS 19750 FA LBS 19750 SA	LB 19750 F LB 19750 S		KBS 19750 A		KB 19750 A		KR 19750		PB 19750	

ENGINE TYPE Motortyp/ tipo de motor/ тип двигателя	LINER KIT Liner Kit/ camisas de los cilindros/ Лайнер комплект	CYL. LINER Zylinderlaufbuchse/ camisas de los cilindros/ втулка цилиндра		PISTON + RINGS Kolben + Ringe/ Pistón + Anillos/ поршень и кольца		PISTON SET Kolben Set/ Pistón Set/ поршневой	RINGS SET Ring Set/ Anillos Set/ кольца	PIN Pin/ Perno/ Пин	
4D94			Liner/ Sleeve	Piston			Rings		
		Length: Outside Ø: Flange Ø: Flange depth:	181.0 108.0 117.0 10.0 +1.0		Length: Comp. height:		103.8 59.7 -3.4	Top: 2nd: oil:	
2,775 cc 4 cyl 94.0 mm Bore Ø		Reference no.:		Reference no.:		Reference no.:	Reference no.:	Reference no.:	
		6142-22-2211 6144-21-2211		O-Ring: 6142-21-2230				129900-23910	
NM-Motorservice Article no./ Artikelnummer/ Modelo número/ статья номер	NM-Motorservice Article no.:	NM-Motorservice Article no.:		NM-Motorservice Article no.:		NM-Motorservice Article no.:	NM-Motorservice Article no.:	NM-Motorservice Article no.:	
	LBS 19800 FA LBS 19800 SA	LB 19800 F LB 19800 S		KBS 19800 A		KB 19800 A	KR 19800	PB 19800	

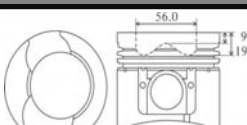
ENGINE TYPE Motortyp/ tipo de motor/ тип двигателя	LINER KIT Liner Kit/ camisas de los cilindros/ Лайнер комплект	CYL. LINER Zylinderlaufbuchse/ camisas de los cilindros/ втулка цилиндра		PISTON + RINGS Kolben + Ringe/ Pistón + Anillos/ поршень и кольца		PISTON SET Kolben Set/ Pistón Set/ поршневой	RINGS SET Ring Set/ Anillos Set/ кольца	PIN Pin/ Perno/ Пин	
4D95			Liner/ Sleeve	Piston			Rings		
		Length: Outside Ø: Flange Ø: Flange depth:	180.0 98.0 104.0 4.0		Length: Comp. height:		94.2 51.1 -10.2 -20.1	Top: 2nd: oil:	
3,260 cc 4 cyl 95.0 mm Bore Ø		Reference no.:		Reference no.:		Reference no.:	Reference no.:	Reference no.:	
		6207-21-2110 6207-21-2120 6207-21-2121				6204-31-2121	6204-31-2200 6204-31-2203	6204-31-3130	
NM-Motorservice Article no./ Artikelnummer/ Modelo número/ статья номер	NM-Motorservice Article no.:	NM-Motorservice Article no.:		NM-Motorservice Article no.:		NM-Motorservice Article no.:	NM-Motorservice Article no.:	NM-Motorservice Article no.:	
	LBS 19850 F LBS 19850 FA	LB 19850 F (phosphated)		KBS 19850 KBS 19850 A		KB 19850 KB 19850 A	KR 19850	PB 19850	

ENGINE TYPE Motortyp/ tipo de motor/ тип двигателя	LINER KIT Liner Kit/ camisas de los cilindros/ Лайнер комплект	CYL. LINER Zylinderlaufbuchse/ camisas de los cilindros/ втулка цилиндра		PISTON + RINGS Kolben + Ringe/ Pistón + Anillos/ поршень и кольца		PISTON SET Kolben Set/ Pistón Set/ поршневой	RINGS SET Ring Set/ Anillos Set/ кольца	PIN Pin/ Perno/ Пин	
S4D95/ S6D95			Liner/ Sleeve	Piston			Rings		
		Length: Outside Ø: Flange Ø: Flange depth:	180.0 98.0 104.0 4.0		Length: Comp. height:		94.2 51.2 -9.5 -19.6	Top: 2nd: oil:	
3,260 cc / 4,890 cc 4 / 6 cyl 95.0 mm Bore Ø		Reference no.:		Reference no.:		Reference no.:	Reference no.:	Reference no.:	
		6207-21-2110 6207-21-2120 6207-21-2121				6207-31-2141	6207-31-2400 6207-31-2500 6207-31-2501	6204-31-3130 6207-31-3130	
NM-Motorservice Article no./ Artikelnummer/ Modelo número/ статья номер	NM-Motorservice Article no.:	NM-Motorservice Article no.:		NM-Motorservice Article no.:		NM-Motorservice Article no.:	NM-Motorservice Article no.:	NM-Motorservice Article no.:	
	LBS 19900 FA LBS 19900-1 FA	LB 19900 F LB 19900 -1 F (phosphated)		KBS 19900-4A KBS 19900-6A		KB 19900-4A KB 19900-6A	KR 19900-4 KR 19900-6	PB 19900-4 PB 19900-6	

ENGINE TYPE Motor/typo/ tipo de motor/ тип двигателя	LINER KIT Liner Kit/ camisas de los cilindros/ Лайнер комплект	CYL. LINER Zylinderlaufbuchse/ camisas de los cilindros/ втулка цилиндра	PISTON + RINGS Kolben + Ringe/ Pistón + Anillos/ поршень и кольца	PISTON SET Kolben Set/ Pistón Set/ поршневой	RINGS SET Ring Set/ Anillos Set/ кольца	PIN Pin/ Perno/ Пин
4D95S 3,260 cc 4 cyl 95.0 mm Bore Ø		Liner/ Sleeve Length: 180.0 Outside Ø: 98.0 Flange Ø: 104.0 Flange depth: 4.0	Piston Length: 104.1 Comp. height: 61.0 -1.7 -3.6		Rings Top: 2.2 2nd: 2.2 oil: 4.0	Ø : 30.0 Length: 74.0
		6207-21-2110 6207-21-2120 6207-21-2121		6202-32-2140	6202-32-2300	6204-31-3130
NM-Motorservice Article no./ Artikelnummer/ Modelo número/ статья номер	NM-Motorservice Article no.:	NM-Motorservice Article no.:	NM-Motorservice Article no.:	NM-Motorservice Article no.:	NM-Motorservice Article no.:	NM-Motorservice Article no.:
	LBS 19950 F LBS 19950 FA	LB 19950 F (phosphated)	KBS 19950 KBS 19950 A	KB 19950 KB 19950 A	KR 19950	PB 19950



ENGINE TYPE Motor/typo/ tipo de motor/ тип двигателя	LINER KIT Liner Kit/ camisas de los cilindros/ Лайнер комплект	CYL. LINER Zylinderlaufbuchse/ camisas de los cilindros/ втулка цилиндра	PISTON + RINGS Kolben + Ringe/ Pistón + Anillos/ поршень и кольца	PISTON SET Kolben Set/ Pistón Set/ поршневой	RINGS SET Ring Set/ Anillos Set/ кольца	PIN Pin/ Perno/ Пин
6D95 4,890 cc 6 cyl 95.0 mm Bore Ø		Liner/ Sleeve Length: 180.0 Outside Ø: 98.0 Flange Ø: 104.0 Flange depth: 4.0	Piston Length: 94.2 Comp. height: 51.1 -9.1 -18.8		Rings Top: 2.0 2nd: 2.0 oil: 4.0	Ø : 30.0 Length: 74.0
		6207-21-2110 6207-21-2120 6207-21-2121		6204-31-2201 6204-31-2202	6207-31-3130	
NM-Motorservice Article no./ Artikelnummer/ Modelo número/ статья номер	NM-Motorservice Article no.:	NM-Motorservice Article no.:	NM-Motorservice Article no.:	NM-Motorservice Article no.:	NM-Motorservice Article no.:	NM-Motorservice Article no.:
	LBS 44250 F LBS 44250 FA	LB 44250 F (phosphated)	KBS 44250 KBS 44250 A	KB 44250 KB 44250 A	KR 44250	PB 44250



ENGINE TYPE Motor/typo/ tipo de motor/ тип двигателя	LINER KIT Liner Kit/ camisas de los cilindros/ Лайнер комплект	CYL. LINER Zylinderlaufbuchse/ camisas de los cilindros/ втулка цилиндра	PISTON + RINGS Kolben + Ringe/ Pistón + Anillos/ поршень и кольца	PISTON SET Kolben Set/ Pistón Set/ поршневой	RINGS SET Ring Set/ Anillos Set/ кольца	PIN Pin/ Perno/ Пин
S6D95L 4,890 cc 6 cyl 95.0 mm Bore Ø		Liner/ Sleeve Length: 180.0 Outside Ø: 98.0 Flange Ø: 104.0 Flange depth: 4.0	Piston Length: 94.2 Comp. height: 51.2 -9.4 -19.6		Rings Top: 2.45 2nd: 2.2 oil: 4.0	Ø : 30.0 Length: 74.0
		6207-21-2110 6207-21-2120 6207-21-2121		6207-31-2180	6209-31-2400	6207-31-3530
NM-Motorservice Article no./ Artikelnummer/ Modelo número/ статья номер	NM-Motorservice Article no.:	NM-Motorservice Article no.:	NM-Motorservice Article no.:	NM-Motorservice Article no.:	NM-Motorservice Article no.:	NM-Motorservice Article no.:
	LBS 20050 F LBS 20050 FA	LB 20050 F (phosphated)	KBS 20050 KBS 20050 A	KB 20050 KB 20050 A	KR 20050	PB 20050

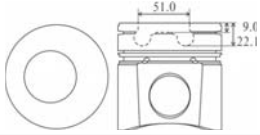

ENGINE TYPE Motortyp/ tipo de motor/ тип двигателя	LINER KIT Liner Kit/ camisas de los cilindros/ Лайнер комплект	CYL. LINER Zylinderlaufbuchse/ camisas de los cilindros/ втулка цилиндра	PISTON + RINGS Kolben + Ringe/ Pistón + Anillos/ поршень и кольца	PISTON SET Kolben Set/ Pistón Set/ поршневой	RINGS SET Ring Set/ Anillos Set/ кольца	PIN Pin/ Perno/ Пин
4D95L 3,260 cc 4 cyl 95.0 mm Bore Ø		Liner/ Sleeve	Piston		Rings	Ø : 30.0 Length: 74.0
		Length: 180.0 Outside Ø: 98.0 Flange Ø: 104.0 Flange depth: 4.0	Length: 94.1 Comp. height: 51.1 -1.8 -3.8		Top: 2.2 2nd: 2.0 oil: 4.0	
		Reference no.:		Reference no.:	Reference no.:	Reference no.:
		6207-21-2110 6207-21-2120 6207-21-2121		6202-32-2120 6204-32-2161	6202-32-2200 6202-32-2202	6204-31-3130
NM-Motorservice Article no./ Artikelnummer/ Modelo número/ статья номер	NM-Motorservice Article no.:	NM-Motorservice Article no.:	NM-Motorservice Article no.:	NM-Motorservice Article no.:	NM-Motorservice Article no.:	NM-Motorservice Article no.:
	LBS 44300 FA	LB 44300 F (phosphated)	KBS 44300 A	KB 44300 A	KR 44300	PB 44300

ENGINE TYPE Motortyp/ tipo de motor/ тип двигателя	LINER KIT Liner Kit/ camisas de los cilindros/ Лайнер комплект	CYL. LINER Zylinderlaufbuchse/ camisas de los cilindros/ втулка цилиндра	PISTON + RINGS Kolben + Ringe/ Pistón + Anillos/ поршень и кольца	PISTON SET Kolben Set/ Pistón Set/ поршневой	RINGS SET Ring Set/ Anillos Set/ кольца	PIN Pin/ Perno/ Пин
4D95 3,260 cc 4 cyl 95.0 mm Bore Ø		Liner/ Sleeve	Piston		Rings	Ø : 30.0 Length: 74.0
		Length: 180.0 Outside Ø: 98.0 Flange Ø: 104.0 Flange depth: 4.0	Length: 104.0 Comp. height: 61.0 -2.0 -3.8		Top: 2.2 2nd: 2.0 oil: 4.0	
		Reference no.:		Reference no.:	Reference no.:	Reference no.:
		6207-21-2110 6207-21-2120 6207-21-2121			6202-32-2200 6202-32-2202	6204-31-3130
NM-Motorservice Article no./ Artikelnummer/ Modelo número/ статья номер	NM-Motorservice Article no.:	NM-Motorservice Article no.:	NM-Motorservice Article no.:	NM-Motorservice Article no.:	NM-Motorservice Article no.:	NM-Motorservice Article no.:
	LBS 20150 F	LB 20150 F (phosphated)	KBS 20150	KB 20150	KR 20150	PB 20150

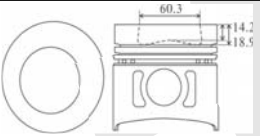
ENGINE TYPE Motortyp/ tipo de motor/ тип двигателя	LINER KIT Liner Kit/ camisas de los cilindros/ Лайнер комплект	CYL. LINER Zylinderlaufbuchse/ camisas de los cilindros/ втулка цилиндра	PISTON + RINGS Kolben + Ringe/ Pistón + Anillos/ поршень и кольца	PISTON SET Kolben Set/ Pistón Set/ поршневой	RINGS SET Ring Set/ Anillos Set/ кольца	PIN Pin/ Perno/ Пин
6D95A 4,890 cc 6 cyl 95.0 mm Bore Ø		Liner/ Sleeve	Piston		Rings	Ø : 30.0 Length: 74.0
		Length: 180.0 Outside Ø: 98.0 Flange Ø: 104.0 Flange depth: 4.0	Length: 104.3 Comp. height: 61.3 -8.0 -15.8		Top: 2.0 2nd: 2.0 oil: 4.0	
		Reference no.:		Reference no.:	Reference no.:	Reference no.:
		6207-21-2110 6207-21-2120 6207-21-2121		6202-33-2150	6204-31-2201 6204-31-2202	6207-31-3130
NM-Motorservice Article no./ Artikelnummer/ Modelo número/ статья номер	NM-Motorservice Article no.:	NM-Motorservice Article no.:	NM-Motorservice Article no.:	NM-Motorservice Article no.:	NM-Motorservice Article no.:	NM-Motorservice Article no.:
	LBS 20200 FA	LB 20200 F (phosphated)	KBS 20200 A	KB 20200 A	KR 20200	PB 20200

ENGINE TYPE Motortyp/ tipo de motor/ тип двигателя	LINER KIT Liner Kit/ camisas de los cilindros/ Лайнер комплект	CYL. LINER Zylinderlaufbuchse/ camisas de los cilindros/ втулка цилиндра	PISTON + RINGS Kolben + Ringe/ Pistón + Anillos/ поршень и кольца	PISTON SET Kolben Set/ Pistón Set/ поршневой	RINGS SET Ring Set/ Anillos Set/ кольца	PIN Pin/ Perno/ Пин
S4D102 S6D102 3,933 cc / 5,900 cc 4 / 6 cyl 102.0 mm Bore Ø		Liner/ Sleeve	Piston		Rings	Ø : 40.0 Length: 83.0
		Length: 200.0 Outside Ø: 104.5 Flange Ø: Flange depth:	Length: 105.4 Comp. height: 71.6 -9.0 -22.1		Top: 2.85 2nd: 2.35 oil: 4.0	
		Reference no.:		Reference no.:	Reference no.:	Reference no.:
		6736-29-2110		6735-31-2110 6735-31-2111 6735-31-2140	6738-31-2030 6738-31-2031	6732-31-3131
NM-Motorservice Article no./ Artikelnummer/ Modelo número/ статья номер	NM-Motorservice Article no.:	NM-Motorservice Article no.:	NM-Motorservice Article no.:	NM-Motorservice Article no.:	NM-Motorservice Article no.:	NM-Motorservice Article no.:
	LBS 20250-4 PA LBS 20250-6 PA	LB 20250-4 P LB 20250-6 P	KBS 20250-4A KBS 20250-6A	KB 20250-4A KB 20250-6A	KR 20250-4 KR 20250-6	PB 20250-4 PB 20250-6

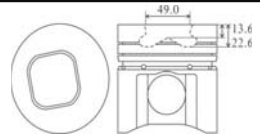
ENGINE TYPE Motortyp/ tipo de motor/ тип двигателя	LINER KIT Liner Kit/ camisas de los cilindros/ Лайнер комплект	CYL. LINER Zylinderlaufbuchse/ camisas de los cilindros/ втулка цилиндра	PISTON + RINGS Kolben + Ringe/ Pistón + Anillos/ поршень и кольца	PISTON SET Kolben Set/ Pistón Set/ поршневой	RINGS SET Ring Set/ Anillos Set/ кольца	PIN Pin/ Perno/ Пин
S6D102 5,900 cc 6 cyl 102.0 mm Bore Ø		Liner/ Sleeve	Piston		Rings	Ø : 34.0 Length: 84.0
		Length: 200.0 Outside Ø: 104.5 Flange Ø: Flange depth:	Length: 97.8 Comp. height: 57.8 -14.2 -18.9		Top: 3.1 2nd: 2.0 oil: 4.0	
		Reference no.:		Reference no.:	Reference no.:	Reference no.:
		6736-29-2110				
NM-Motorservice Article no./ Artikelnummer/ Modelo número/ статья номер	NM-Motorservice Article no.:	NM-Motorservice Article no.:	NM-Motorservice Article no.:	NM-Motorservice Article no.:	NM-Motorservice Article no.:	NM-Motorservice Article no.:
	LBS 20300 PA	LB 20300 P	KBS 20300 A	KB 20300 A	KR 20300	PB 20300

ENGINE TYPE Motortyp/ tipo de motor/ тип двигателя	LINER KIT Liner Kit/ camisas de los cilindros/ Лайнер комплект	CYL. LINER Zylinderlaufbuchse/ camisas de los cilindros/ втулка цилиндра	PISTON + RINGS Kolben + Ringe/ Pistón + Anillos/ поршень и кольца	PISTON SET Kolben Set/ Pistón Set/ поршневой	RINGS SET Ring Set/ Anillos Set/ кольца	PIN Pin/ Perno/ Пин
4D105 6D105 4,326 cc / 6,490 cc 4/6 cyl 105.0 mm Bore Ø		Liner/ Sleeve	Piston		Rings	Ø : 40.0 Length: 84.0
		Length: 223.0 Outside Ø: 118.7 Flange Ø: 127.0 Flange depth: 10.0 +1.0	Length: 107.5 Comp. height: 69.0 -13.6 -22.6		Top: 3.0 2nd: 2.5 oil: 5.0	
		Reference no.:	Reference no.:	Reference no.:	Reference no.:	Reference no.:
		6136-21-2210 6137-21-2210 6137-22-2210	O-Ring: 6136-21-2220 6136-21-2230 6136-21-2240	6136-31-2012 6136-31-2112	6130-31-2202 6130-32-2202 6130-32-2301 6130-32-2302 6136-31-2010 6136-31-2030	6136-31-3130
NM-Motorservice Article no./ Artikelnummer/ Modelo número/ статья номер	NM-Motorservice Article no.:	NM-Motorservice Article no.:	NM-Motorservice Article no.:	NM-Motorservice Article no.:	NM-Motorservice Article no.:	NM-Motorservice Article no.:
	LBS 20350-4 FA LBS 20350-6 FA	LB 20350-4 F LB 20350-6 F (Phosphated)	KBS 20350-4A KBS 20350-6A	KB 20350-4A KB 20350-6A	KR 20350-4 KR 20350-6	PB 20350-4 PB 20350-6

ENGINE TYPE Motortyp/ tipo de motor/ тип двигателя	LINER KIT Liner Kit/ camisas de los cilindros/ Лайнер комплект	CYL. LINER Zylinderlaufbuchse/ camisas de los cilindros/ втулка цилиндра	PISTON + RINGS Kolben + Ringe/ Pistón + Anillos/ поршень и кольца	PISTON SET Kolben Set/ Pistón Set/ поршневой	RINGS SET Ring Set/ Anillos Set/ кольца	PIN Pin/ Perno/ Пин
4D105-3C 4,330 cc 4 cyl 105.0 mm Bore Ø		Liner/ Sleeve	Piston		Rings	Ø : 38.0 Length: 88.0
		Length: 223.0 Outside Ø: 118.0 Flange Ø: 125.5 Flange depth: 10.0 1.0	Length: 107.5 Comp. height: 69.0 -12.6 -20.6		Top: 3.0 2nd: 2.5 oil: 5.0	
		Reference no.:	Reference no.:	Reference no.:	Reference no.:	Reference no.:
		6130-22-2310	O-Ring: 6130-21-2220 6130-21-2230	6130-32-2110	6130-31-2202 6130-32-2202 6130-32-2301 6130-32-2302	6130-31-3130
NM-Motorservice Article no./ Artikelnummer/ Modelo número/ статья номер	NM-Motorservice Article no.:	NM-Motorservice Article no.:	NM-Motorservice Article no.:	NM-Motorservice Article no.:	NM-Motorservice Article no.:	NM-Motorservice Article no.:
	LBS 20400 F LBS 20400 FA	LB 20400 F (phosphated)	KBS 20400 KBS 20400 A	KB 20400 KB 20400 A	KR 20400	PB 20400



ENGINE TYPE Motortyp/ tipo de motor/ тип двигателя	LINER KIT Liner Kit/ camisas de los cilindros/ Лайнер комплект	CYL. LINER Zylinderlaufbuchse/ camisas de los cilindros/ втулка цилиндра	PISTON + RINGS Kolben + Ringe/ Pistón + Anillos/ поршень и кольца	PISTON SET Kolben Set/ Pistón Set/ поршневой	RINGS SET Ring Set/ Anillos Set/ кольца	PIN Pin/ Perno/ Пин
6D105 6,490 cc 6 cyl 105.0 mm Bore Ø		Liner/ Sleeve	Piston		Rings	Ø : 40.0 Length: 86.0
		Length: 223.0 Outside Ø: 118.7 Flange Ø: 127.0 Flange depth: 10.0 +1.0	Length: 107.5 Comp. height: 69.0 -13.5 -22.7		Top: 3.0 2nd: 2.5 oil: 5.0	
		Reference no.:	Reference no.:	Reference no.:	Reference no.:	Reference no.:
		6136-21-2210 6137-21-2210 6137-22-2210	O-Ring: 6136-21-2220 6136-21-2230 6136-21-2240	6137-31-2020	6137-31-2040	6136-32-3130
NM-Motorservice Article no./ Artikelnummer/ Modelo número/ статья номер	NM-Motorservice Article no.:	NM-Motorservice Article no.:	NM-Motorservice Article no.:	NM-Motorservice Article no.:	NM-Motorservice Article no.:	NM-Motorservice Article no.:
	LBS 20450 FA	LB 20450 F (phosphated)	KBS 20450 A	KB 20450 A	KR 20450	PB 20450



ENGINE TYPE Motortyp/ tipo de motor/ тип двигателя	LINER KIT Liner Kit/ camisas de los cilindros/ Лайнер комплект	CYL. LINER Zylinderlaufbuchse/ camisas de los cilindros/ втулка цилиндра	PISTON + RINGS Kolben + Ringe/ Pistón + Anillos/ поршень и кольца	PISTON SET Kolben Set/ Pistón Set/ поршневой	RINGS SET Ring Set/ Anillos Set/ кольца	PIN Pin/ Perno/ Пин
4D105 6D105 4,326 cc/ 6,490 cc 4/6 cyl 105.0 mm Bore Ø		Liner/ Sleeve	Piston		Rings	Ø : 40.0 Length: 83.5
		Length: 223.0 Outside Ø: 118.7 Flange Ø: 127.0 Flange depth: 10.0 +1.0	Length: 107.7 Comp. height: 69.2 -15.5 -22.8		Top: 3.0 2nd: 2.5 oil: 5.0	
		Reference no.:	Reference no.:	Reference no.:	Reference no.:	Reference no.:
		6136-21-2210 6137-21-2210 6137-22-2210	O-Ring: 6136-21-2220 6136-21-2230 6136-21-2240	6136-32-2010 6136-32-2110	6130-31-2202 6130-32-2202 6130-32-2301 6130-32-2302 6136-31-2010 6136-31-2030	6136-32-3130
NM-Motorservice Article no./ Artikelnummer/ Modelo número/ статья номер	NM-Motorservice Article no.:	NM-Motorservice Article no.:	NM-Motorservice Article no.:	NM-Motorservice Article no.:	NM-Motorservice Article no.:	NM-Motorservice Article no.:
	LBS 44700-4 FA LBS 44700-6 FA	LB 44700-4 F LB 44700-6 F (phosphated)	KBS 44700-4A KBS 44700-6A	KB 44700-4A KB 44700-6A	KR 44700-4 KR 44700-6	PB 44700-4 PB 44700-6

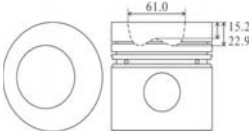

ENGINE TYPE Motortyp/ tipo de motor/ тип двигателя	LINER KIT Liner Kit/ camisas de los cilindros/ Лайнер комплект	CYL. LINER Zylinderlaufbuchse/ camisas de los cilindros/ втулка цилиндра	PISTON + RINGS Kolben + Ringe/ Pistón + Anillos/ поршень и кольца	PISTON SET Kolben Set/ Pistón Set/ поршневой	RINGS SET Ring Set/ Anillos Set/ кольца	PIN Pin/ Perno/ Пин			
SA6D105 6,490 cc 6 cyl 105.0 mm Bore Ø		Liner/ Sleeve	Piston		Rings				
		Length: Outside Ø: Flange Ø: Flange depth:	223.0 118.7 127.0 10.0 +1.0	Length: Comp. height:	107.7 69.2 -16.2 -23.7	Top: 2nd: oil:	3.0 2.5 5.0	Ø : Length:	40.0 86.0
		Reference no.:	Reference no.:	Reference no.:	Reference no.:	Reference no.:			
		6136-21-2210 6137-21-2210 6137-22-2210	O-Ring: 6136-21-2220 6136-21-2230 6136-21-2240	6137-32-2030 6137-32-2130	6137-31-2040	6136-32-3130			
NM-Motorservice Article no./ Artikelnummer/ Modelo número/ статья номер	NM-Motorservice Article no.:	NM-Motorservice Article no.:	NM-Motorservice Article no.:	NM-Motorservice Article no.:	NM-Motorservice Article no.:	NM-Motorservice Article no.:			
	LBS 20550 FA	LB 20550 F (phosphated)	KBS 20550 A	KB 20550 A	KR 20550	PB 20550			

ENGINE TYPE Motortyp/ tipo de motor/ тип двигателя	LINER KIT Liner Kit/ camisas de los cilindros/ Лайнер комплект	CYL. LINER Zylinderlaufbuchse/ camisas de los cilindros/ втулка цилиндра	PISTON + RINGS Kolben + Ringe/ Pistón + Anillos/ поршень и кольца	PISTON SET Kolben Set/ Pistón Set/ поршневой	RINGS SET Ring Set/ Anillos Set/ кольца	PIN Pin/ Perno/ Пин			
S4D105 4,330 cc 4 cyl 105.0 mm Bore Ø		Liner/ Sleeve	Piston		Rings				
		Length: Outside Ø: Flange Ø: Flange depth:	223.0 118.0 125.5 10.0 +1.0	Length: Comp. height:	107.5 69.0 -15.2 -22.9	Top: 2nd: oil:	3.0 2.5 5.0	Ø : Length:	38.0 88.0
		Reference no.:	Reference no.:	Reference no.:	Reference no.:	Reference no.:			
		6130-22-2310	O-Ring: 6130-21-2220 6130-21-2230	6131-32-2120	6130-31-2201 6130-31-2301 6131-31-2201 6131-31-2301 6131-32-2201 6131-32-2301 6131-32-2302	6130-31-3130			
NM-Motorservice Article no./ Artikelnummer/ Modelo número/ статья номер	NM-Motorservice Article no.:	NM-Motorservice Article no.:	NM-Motorservice Article no.:	NM-Motorservice Article no.:	NM-Motorservice Article no.:	NM-Motorservice Article no.:			
	LBS 20600 FA	LB 20600 F (phosphated)	KBS 20600 A	KB 20600 A	KR 20600	PB 20600			

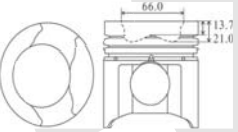
ENGINE TYPE Motortyp/ tipo de motor/ тип двигателя	LINER KIT Liner Kit/ camisas de los cilindros/ Лайнер комплект	CYL. LINER Zylinderlaufbuchse/ camisas de los cilindros/ втулка цилиндра	PISTON + RINGS Kolben + Ringe/ Pistón + Anillos/ поршень и кольца	PISTON SET Kolben Set/ Pistón Set/ поршневой	RINGS SET Ring Set/ Anillos Set/ кольца	PIN Pin/ Perno/ Пин			
SA6D105 6,490 cc 6 cyl 105.0 mm Bore Ø		Liner/ Sleeve	Piston		Rings				
		Length: Outside Ø: Flange Ø: Flange depth:	223.0 118.7 127.0 10.0 1.0	Length: Comp. height:	107.7 69.2 -14.7 -22.2	Top: 2nd: oil:	3.0 2.5 5.0	Ø : Length:	40.0 86.0
		Reference no.:	Reference no.:	Reference no.:	Reference no.:	Reference no.:			
		6136-21-2210 6137-21-2210 6137-22-2210	6136-21-2220 6136-21-2230 6136-21-2240	6137-32-2010 6137-32-2110	6137-31-2040	6136-32-3130			
NM-Motorservice Article no./ Artikelnummer/ Modelo número/ статья номер	NM-Motorservice Article no.:	NM-Motorservice Article no.:	NM-Motorservice Article no.:	NM-Motorservice Article no.:	NM-Motorservice Article no.:	NM-Motorservice Article no.:			
	LBS 26650 FA	LB 26650 F (phosphated)	KBS 26650 A	KB 26650 A	KR 26650	PB 26650			

ENGINE TYPE Motortyp/ tipo de motor/ тип двигателя	LINER KIT Liner Kit/ camisas de los cilindros/ Лайнер комплект	CYL. LINER Zylinderlaufbuchse/ camisas de los cilindros/ втулка цилиндра	PISTON + RINGS Kolben + Ringe/ Pistón + Anillos/ поршень и кольца	PISTON SET Kolben Set/ Pistón Set/ поршневой	RINGS SET Ring Set/ Anillos Set/ кольца	PIN Pin/ Perno/ Пин																																														
4D105		<table border="1"> <tr> <td></td> <td>Liner/ Sleeve</td> <td></td> </tr> <tr> <td>Length:</td> <td>223.0</td> <td></td> </tr> <tr> <td>Outside Ø:</td> <td>118.7</td> <td></td> </tr> <tr> <td>Flange Ø:</td> <td>127.0</td> <td></td> </tr> <tr> <td>Flange depth:</td> <td>10.0</td> <td>+1.0</td> </tr> </table>		Liner/ Sleeve		Length:	223.0		Outside Ø:	118.7		Flange Ø:	127.0		Flange depth:	10.0	+1.0	<table border="1"> <tr> <td></td> <td>Piston</td> <td></td> </tr> <tr> <td>Length:</td> <td>107.5</td> <td></td> </tr> <tr> <td>Comp. height:</td> <td>69.0</td> <td></td> </tr> <tr> <td></td> <td>-15.2</td> <td></td> </tr> <tr> <td></td> <td>-22.9</td> <td></td> </tr> </table>		Piston		Length:	107.5		Comp. height:	69.0			-15.2			-22.9			<table border="1"> <tr> <td></td> <td>Rings</td> <td></td> </tr> <tr> <td>Top:</td> <td>3.5</td> <td rowspan="3">Ø: Length:</td> </tr> <tr> <td>2nd: oil:</td> <td>3.5</td> </tr> <tr> <td></td> <td>5.0</td> </tr> <tr> <td></td> <td></td> <td>38.0</td> </tr> <tr> <td></td> <td></td> <td>88.0</td> </tr> </table>		Rings		Top:	3.5	Ø: Length:	2nd: oil:	3.5		5.0			38.0			88.0	
				Liner/ Sleeve																																																
Length:	223.0																																																			
Outside Ø:	118.7																																																			
Flange Ø:	127.0																																																			
Flange depth:	10.0	+1.0																																																		
	Piston																																																			
Length:	107.5																																																			
Comp. height:	69.0																																																			
	-15.2																																																			
	-22.9																																																			
	Rings																																																			
Top:	3.5	Ø: Length:																																																		
2nd: oil:	3.5																																																			
	5.0																																																			
		38.0																																																		
		88.0																																																		
4,330 cc 4 cyl 105.0 mm Bore Ø		Reference no.:	Reference no.:	Reference no.:	Reference no.:	Reference no.:																																														
		6136-21-2210 6137-21-2210 6137-22-2210	O-Ring: 6130-21-2220 6130-21-2230			6130-31-3130																																														
NM-Motorservice Article no./ Artikelnummer/ Modelo número/ статья номер	NM-Motorservice Article no.:	NM-Motorservice Article no.:	NM-Motorservice Article no.:	NM-Motorservice Article no.:	NM-Motorservice Article no.:	NM-Motorservice Article no.:																																														
	LBS 20700 FA	LB 20700 F (phosphated)	KBS 20700 A	KB 20700 A	KR 20700	PB 20700																																														

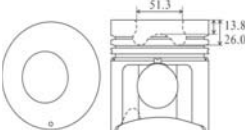

ENGINE TYPE Motortyp/ tipo de motor/ тип двигателя	LINER KIT Liner Kit/ camisas de los cilindros/ Лайнер комплект	CYL. LINER Zylinderlaufbuchse/ camisas de los cilindros/ втулка цилиндра	PISTON + RINGS Kolben + Ringe/ Pistón + Anillos/ поршень и кольца	PISTON SET Kolben Set/ Pistón Set/ поршневой	RINGS SET Ring Set/ Anillos Set/ кольца	PIN Pin/ Perno/ Пин																																														
SA6D108		<table border="1"> <tr> <td></td> <td>Liner/ Sleeve</td> <td></td> </tr> <tr> <td>Length:</td> <td>219.5</td> <td></td> </tr> <tr> <td>Outside Ø:</td> <td>111.5</td> <td></td> </tr> <tr> <td>Flange Ø:</td> <td>120.0</td> <td></td> </tr> <tr> <td>Flange depth:</td> <td>5.0</td> <td>+1.0</td> </tr> </table>		Liner/ Sleeve		Length:	219.5		Outside Ø:	111.5		Flange Ø:	120.0		Flange depth:	5.0	+1.0	<table border="1"> <tr> <td></td> <td>Piston</td> <td></td> </tr> <tr> <td>Length:</td> <td>113.8</td> <td></td> </tr> <tr> <td>Comp. height:</td> <td>66.7</td> <td></td> </tr> <tr> <td></td> <td>-13.7</td> <td></td> </tr> <tr> <td></td> <td>-21.0</td> <td></td> </tr> </table>		Piston		Length:	113.8		Comp. height:	66.7			-13.7			-21.0			<table border="1"> <tr> <td></td> <td>Rings</td> <td></td> </tr> <tr> <td>Top:</td> <td>2.43</td> <td rowspan="3">Ø: Length:</td> </tr> <tr> <td>2nd: oil:</td> <td>2.5</td> </tr> <tr> <td></td> <td>4.0</td> </tr> <tr> <td></td> <td></td> <td>45.0</td> </tr> <tr> <td></td> <td></td> <td>85.0</td> </tr> </table>		Rings		Top:	2.43	Ø: Length:	2nd: oil:	2.5		4.0			45.0			85.0	
				Liner/ Sleeve																																																
Length:	219.5																																																			
Outside Ø:	111.5																																																			
Flange Ø:	120.0																																																			
Flange depth:	5.0	+1.0																																																		
	Piston																																																			
Length:	113.8																																																			
Comp. height:	66.7																																																			
	-13.7																																																			
	-21.0																																																			
	Rings																																																			
Top:	2.43	Ø: Length:																																																		
2nd: oil:	2.5																																																			
	4.0																																																			
		45.0																																																		
		85.0																																																		
7,145 cc 6 cyl 108.0 mm Bore Ø		Reference no.:	Reference no.:	Reference no.:	Reference no.:	Reference no.:																																														
		6222-21-2110 6222-23-2231		6222-31-2110	6221-31-2200	6221-31-3130																																														
NM-Motorservice Article no./ Artikelnummer/ Modelo número/ статья номер	NM-Motorservice Article no.:	NM-Motorservice Article no.:	NM-Motorservice Article no.:	NM-Motorservice Article no.:	NM-Motorservice Article no.:	NM-Motorservice Article no.:																																														
	LBS 20750 FA	LB 20750 F (phosphated)	KBS 20750 A	KB 20750 A	KR 20750	PB 20750																																														



ENGINE TYPE Motortyp/ tipo de motor/ тип двигателя	LINER KIT Liner Kit/ camisas de los cilindros/ Лайнер комплект	CYL. LINER Zylinderlaufbuchse/ camisas de los cilindros/ втулка цилиндра	PISTON + RINGS Kolben + Ringe/ Pistón + Anillos/ поршень и кольца	PISTON SET Kolben Set/ Pistón Set/ поршневой	RINGS SET Ring Set/ Anillos Set/ кольца	PIN Pin/ Perno/ Пин																																														
S6D108		<table border="1"> <tr> <td></td> <td>Liner/ Sleeve</td> <td></td> </tr> <tr> <td>Length:</td> <td>219.5</td> <td></td> </tr> <tr> <td>Outside Ø:</td> <td>111.5</td> <td></td> </tr> <tr> <td>Flange Ø:</td> <td>120.0</td> <td></td> </tr> <tr> <td>Flange depth:</td> <td>5.0</td> <td>+1.0</td> </tr> </table>		Liner/ Sleeve		Length:	219.5		Outside Ø:	111.5		Flange Ø:	120.0		Flange depth:	5.0	+1.0	<table border="1"> <tr> <td></td> <td>Piston</td> <td></td> </tr> <tr> <td>Length:</td> <td>113.8</td> <td></td> </tr> <tr> <td>Comp. height:</td> <td>66.7</td> <td></td> </tr> <tr> <td></td> <td>-13.8</td> <td></td> </tr> <tr> <td></td> <td>-26.0</td> <td></td> </tr> </table>		Piston		Length:	113.8		Comp. height:	66.7			-13.8			-26.0		Pistons are alfin and with oil gallery	<table border="1"> <tr> <td></td> <td>Rings</td> <td></td> </tr> <tr> <td>Top:</td> <td>2.43</td> <td rowspan="3">Ø: Length:</td> </tr> <tr> <td>2nd: oil:</td> <td>2.5</td> </tr> <tr> <td></td> <td>4.0</td> </tr> <tr> <td></td> <td></td> <td>45.0</td> </tr> <tr> <td></td> <td></td> <td>85.0</td> </tr> </table>		Rings		Top:	2.43	Ø: Length:	2nd: oil:	2.5		4.0			45.0			85.0	
				Liner/ Sleeve																																																
Length:	219.5																																																			
Outside Ø:	111.5																																																			
Flange Ø:	120.0																																																			
Flange depth:	5.0	+1.0																																																		
	Piston																																																			
Length:	113.8																																																			
Comp. height:	66.7																																																			
	-13.8																																																			
	-26.0																																																			
	Rings																																																			
Top:	2.43	Ø: Length:																																																		
2nd: oil:	2.5																																																			
	4.0																																																			
		45.0																																																		
		85.0																																																		
7,145 cc 6 cyl 108.0 mm Bore Ø		Reference no.:	Reference no.:	Reference no.:	Reference no.:	Reference no.:																																														
		6222-21-2110 6222-23-2231		6222-33-2110	6221-31-220	6221-31-3130																																														
NM-Motorservice Article no./ Artikelnummer/ Modelo número/ статья номер	NM-Motorservice Article no.:	NM-Motorservice Article no.:	NM-Motorservice Article no.:	NM-Motorservice Article no.:	NM-Motorservice Article no.:	NM-Motorservice Article no.:																																														
	LBS 20800 FB	LB 20800 F (phosphated)	KBS 20800 B	KB 20800 B	KR 20800	PB 20800																																														



ENGINE TYPE Motortyp/ tipo de motor/ тип двигателя	LINER KIT Liner Kit/ camisas de los cilindros/ Лайнер комплект	CYL. LINER Zylinderlaufbuchse/ camisas de los cilindros/ втулка цилиндра	PISTON + RINGS Kolben + Ringe/ Pistón + Anillos/ поршень и кольца	PISTON SET Kolben Set/ Pistón Set/ поршневой	RINGS SET Ring Set/ Anillos Set/ кольца	PIN Pin/ Perno/ Пин	
S6D110 7,130 cc 6 cyl 110.0 mm Bore Ø		Liner/ Sleeve	Piston		Rings		
		Length: Outside Ø: Flange Ø: Flange depth:	225.0 115.0 120.0 5.0 +1.0	Length: Comp. height:	116.0 69.0 -11.5 -20.5	Top: 2nd: oil:	3.0 2.5 5.0
		Reference no.:		Reference no.:	Reference no.:	Reference no.:	
		6138-21-2210 6138-21-2220		6138-31-2010	6138-32-2200	6138-31-3133	
NM-Motorservice Article no./ Artikelnummer/ Modelo número/ статья номер	NM-Motorservice Article no.:	NM-Motorservice Article no.:	NM-Motorservice Article no.:	NM-Motorservice Article no.:	NM-Motorservice Article no.:	NM-Motorservice Article no.:	
	LBS 20850 FA	LB 20850 F (phosphated)	KBS 20850 A	KB 20850 A	KR 20850	PB 20850	

ENGINE TYPE Motortyp/ tipo de motor/ тип двигателя	LINER KIT Liner Kit/ camisas de los cilindros/ Лайнер комплект	CYL. LINER Zylinderlaufbuchse/ camisas de los cilindros/ втулка цилиндра	PISTON + RINGS Kolben + Ringe/ Pistón + Anillos/ поршень и кольца	PISTON SET Kolben Set/ Pistón Set/ поршневой	RINGS SET Ring Set/ Anillos Set/ кольца	PIN Pin/ Perno/ Пин	
SA6D110 7,130 cc 6 cyl 110.0 mm Bore Ø		Liner/ Sleeve	Piston		Rings		
		Length: Outside Ø: Flange Ø: Flange depth:	225.0 115.0 120.0 5.0 +1.0	Length: Comp. height:	116.2 69.2 -13.0 -22.0	Top: 2nd: oil:	3.0 2.5 5.0
		Reference no.:		Reference no.:	Reference no.:	Reference no.:	
		6138-21-2210 6138-21-2220		6138-32-2120	6138-32-2200	6138-31-3133	
NM-Motorservice Article no./ Artikelnummer/ Modelo número/ статья номер	NM-Motorservice Article no.:	NM-Motorservice Article no.:	NM-Motorservice Article no.:	NM-Motorservice Article no.:	NM-Motorservice Article no.:	NM-Motorservice Article no.:	
	LBS 20900 FA	LB 20900 F (phosphated)	KBS 20900 A	KB 20900 A	KR 20900	PB 20900	

ENGINE TYPE Motortyp/ tipo de motor/ тип двигателя	LINER KIT Liner Kit/ camisas de los cilindros/ Лайнер комплект	CYL. LINER Zylinderlaufbuchse/ camisas de los cilindros/ втулка цилиндра	PISTON + RINGS Kolben + Ringe/ Pistón + Anillos/ поршень и кольца	PISTON SET Kolben Set/ Pistón Set/ поршневой	RINGS SET Ring Set/ Anillos Set/ кольца	PIN Pin/ Perno/ Пин	
6D110 7,130 cc 6 cyl 110.0 mm Bore Ø		Liner/ Sleeve	Piston		Rings		
		Length: Outside Ø: Flange Ø: Flange depth:	225.0 115.0 120.0 5.0 +1.0	Length: Comp. height:	116.2 69.2 -14.8 -22.8	Top: 2nd: oil:	3.0 2.5 5.0
		Reference no.:		Reference no.:	Reference no.:	Reference no.:	
		6138-21-2210 6138-21-2220		6138-32-2110	6138-32-2200	6138-31-3133	
NM-Motorservice Article no./ Artikelnummer/ Modelo número/ статья номер	NM-Motorservice Article no.:	NM-Motorservice Article no.:	NM-Motorservice Article no.:	NM-Motorservice Article no.:	NM-Motorservice Article no.:	NM-Motorservice Article no.:	
	LBS 20950 FA	LB 20950 F (phosphated)	KBS 20950 A	KB 20950 A	KR 20950	PB 20950	

ENGINE TYPE Motortyp/ tipo de motor/ тип двигателя	LINER KIT Liner Kit/ camisas de los cilindros/ Лайнер комплект	CYL. LINER Zylinderlaufbuchse/ camisas de los cilindros/ втулка цилиндра	PISTON + RINGS Kolben + Ringe/ Pistón + Anillos/ поршень и кольца	PISTON SET Kolben Set/ Pistón Set/ поршневой	RINGS SET Ring Set/ Anillos Set/ кольца	PIN Pin/ Perno/ Пин
S6D110 7,130 cc 6 cyl 110.0 mm Bore Ø		Liner/ Sleeve	Piston		Rings	Ø : 40.0 Length: 90.5
		Length: 225.0 Outside Ø: 115.0 Flange Ø: 120.0 Flange depth: 5.0 +1.0	Length: 116.2 Comp. height: 69.2 -11.3 -20.4		Top: 3.0 2nd: 2.5 oil: 5.0	
		Reference no.:		Reference no.:	Reference no.:	Reference no.:
		6138-21-2210 6138-21-2220			6138-32-2200	6138-31-3133
NM-Motorservice Article no./ Artikelnummer/ Modelo número/ статья номер	NM-Motorservice Article no.:	NM-Motorservice Article no.:	NM-Motorservice Article no.:	NM-Motorservice Article no.:	NM-Motorservice Article no.:	NM-Motorservice Article no.:
	LBS 21000 FA	LB 21000 F (phosphated)	KBS 21000 A	KB 21000 A	KR 21000	PB 21000

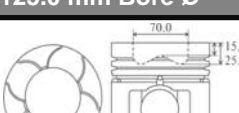

ENGINE TYPE Motortyp/ tipo de motor/ тип двигателя	LINER KIT Liner Kit/ camisas de los cilindros/ Лайнер комплект	CYL. LINER Zylinderlaufbuchse/ camisas de los cilindros/ втулка цилиндра	PISTON + RINGS Kolben + Ringe/ Pistón + Anillos/ поршень и кольца	PISTON SET Kolben Set/ Pistón Set/ поршневой	RINGS SET Ring Set/ Anillos Set/ кольца	PIN Pin/ Perno/ Пин
4D120 7,240 cc 4 cyl 120.0 mm Bore Ø		Liner/ Sleeve	Piston		Rings	Ø : 44.0 Length: 100.0
		Length: 293.0 Outside Ø: 140.0 Flange Ø: 150.0 Flange depth: 13.0 +1.0	Length: 134.9 Comp. height: 90.0 -4.3 -7.1		Top: 3.5 2nd: 2.5 oil: 5.5	
		Reference no.:		Reference no.:	Reference no.:	Reference no.:
		6110-21-2212		6110-33-2132	6110-30-2301 6110-30-2302 6110-30-2303 6110-30-2401 6110-30-2402 6110-30-2403 6113-30-2301 6113-30-2401	
NM-Motorservice Article no./ Artikelnummer/ Modelo número/ статья номер	NM-Motorservice Article no.:	NM-Motorservice Article no.:	NM-Motorservice Article no.:	NM-Motorservice Article no.:	NM-Motorservice Article no.:	NM-Motorservice Article no.:
	LBS 21050 FA	LB 21050 F (phosphated)	KBS 21050 A	KB 21050 A	KR 21050	



ENGINE TYPE Motortyp/ tipo de motor/ тип двигателя	LINER KIT Liner Kit/ camisas de los cilindros/ Лайнер комплект	CYL. LINER Zylinderlaufbuchse/ camisas de los cilindros/ втулка цилиндра	PISTON + RINGS Kolben + Ringe/ Pistón + Anillos/ поршень и кольца	PISTON SET Kolben Set/ Pistón Set/ поршневой	RINGS SET Ring Set/ Anillos Set/ кольца	PIN Pin/ Perno/ Пин
6D125 11,040 cc 6 cyl 125.0 mm Bore Ø		Liner/ Sleeve	Piston		Rings	Ø : 48.0 Length: 104.0
		Length: 256.5 Outside Ø: 141.4 Flange Ø: 153.0 Flange depth: 10.0 +2.0	Length: 131.1 Comp. height: 80.1 -15.7 -25.7		Top: 2.4 2nd: 2.4 oil: 4.0	
		Reference no.:	Reference no.:	Reference no.:	Reference no.:	Reference no.:
		6150-21-2221 6151-22-2220	6150-21-2230 6150-21-2240 6150-21-2250	6150-31-2012 6150-31-2112	6150-31-2032 6150-31-2033	6150-31-3130
NM-Motorservice Article no./ Artikelnummer/ Modelo número/ статья номер	NM-Motorservice Article no.:	NM-Motorservice Article no.:	NM-Motorservice Article no.:	NM-Motorservice Article no.:	NM-Motorservice Article no.:	NM-Motorservice Article no.:
	LBS 21100 FA	LB 21100 F (phosphated)	KBS 21100 A	KB 21100 A	KR 21100	PB 21100

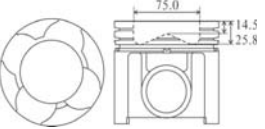

ENGINE TYPE Motortyp/ tipo de motor/ тип двигателя	LINER KIT Liner Kit/ camisas de los cilindros/ Лайнер комплект	CYL. LINER Zylinderlaufbuchse/ camisas de los cilindros/ втулка цилиндра	PISTON + RINGS Kolben + Ringe/ Pistón + Anillos/ поршень и кольца	PISTON SET Kolben Set/ Pistón Set/ поршневой	RINGS SET Ring Set/ Anillos Set/ кольца	PIN Pin/ Perno/ Пин	
S6D125 11,040 cc 6 cyl 125.0 mm Bore Ø		Liner/ Sleeve	Piston		Rings		
		Length: Outside Ø: Flange Ø: Flange depth:	256.5 141.4 153.0 10.0 +2.0	Length: Comp. height:	131.1 80.1 -13.5 -24.7	Top: 2nd: oil:	2.4 2.4 4.0
		Reference no.:	Reference no.:	Reference no.:	Reference no.:	Reference no.:	
		6150-21-2221 6151-22-2220	6150-21-2230 6150-21-2240 6150-21-2250	6151-31-2071 6151-31-2171	6150-31-2032 6150-31-2033	6151-31-3230	
NM-Motorservice Article no./ Artikelnummer/ Modelo número/ статья номер	NM-Motorservice Article no.:	NM-Motorservice Article no.:	NM-Motorservice Article no.:	NM-Motorservice Article no.:	NM-Motorservice Article no.:	NM-Motorservice Article no.:	
	LBS 21150 FA	LB 21150 F (phosphated)	KBS 21150 A	KB 21150 A	KR 21150	PB 21150	

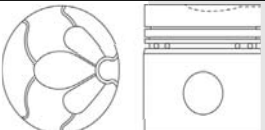

ENGINE TYPE Motortyp/ tipo de motor/ тип двигателя	LINER KIT Liner Kit/ camisas de los cilindros/ Лайнер комплект	CYL. LINER Zylinderlaufbuchse/ camisas de los cilindros/ втулка цилиндра	PISTON + RINGS Kolben + Ringe/ Pistón + Anillos/ поршень и кольца	PISTON SET Kolben Set/ Pistón Set/ поршневой	RINGS SET Ring Set/ Anillos Set/ кольца	PIN Pin/ Perno/ Пин	
S6D125 11,040 cc 6 cyl 125.0 mm Bore Ø		Liner/ Sleeve	Piston		Rings		
		Length: Outside Ø: Flange Ø: Flange depth:	256.5 141.4 153.0 10.0 +2.0	Length: Comp. height:	131.1 80.1 -12.9 -24.1	Top: 2nd: oil:	2.4 2.4 4.0
		Reference no.:	Reference no.:	Reference no.:	Reference no.:	Reference no.:	
		6150-21-2221 6151-22-2220	O-Ring: 6150-21-2230 6150-21-2240 6150-21-2250	6151-31-2060 6151-31-2150	6150-31-2032 6150-31-2033	6150-31-3130	
NM-Motorservice Article no./ Artikelnummer/ Modelo número/ статья номер	NM-Motorservice Article no.:	NM-Motorservice Article no.:	NM-Motorservice Article no.:	NM-Motorservice Article no.:	NM-Motorservice Article no.:	NM-Motorservice Article no.:	
	LBS 21200 FA	LB 21200 F (phosphated)	KBS 21200 A	KB 21200 A	KR 21200	PB 21200	

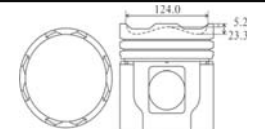

ENGINE TYPE Motortyp/ tipo de motor/ тип двигателя	LINER KIT Liner Kit/ camisas de los cilindros/ Лайнер комплект	CYL. LINER Zylinderlaufbuchse/ camisas de los cilindros/ втулка цилиндра	PISTON + RINGS Kolben + Ringe/ Pistón + Anillos/ поршень и кольца	PISTON SET Kolben Set/ Pistón Set/ поршневой	RINGS SET Ring Set/ Anillos Set/ кольца	PIN Pin/ Perno/ Пин	
S6D125 11,040 cc 6 cyl 125.0 mm Bore Ø		Liner/ Sleeve	Piston		Rings		
		Length: Outside Ø: Flange Ø: Flange depth:	256.5 141.4 153.0 10.0 +2.0	Length: Comp. height:	131.1 80.1 -6.6 -24.0	Top: 2nd: oil:	2.4 2.4 4.0
		Reference no.:	Reference no.:	Reference no.:	Reference no.:	Reference no.:	
		6150-21-2221 6151-22-2220	O-Ring: 6150-21-2230 6150-21-2240 6150-21-2250		6150-31-2032 6150-31-2033	6150-31-3130	
NM-Motorservice Article no./ Artikelnummer/ Modelo número/ статья номер	NM-Motorservice Article no.:	NM-Motorservice Article no.:	NM-Motorservice Article no.:	NM-Motorservice Article no.:	NM-Motorservice Article no.:	NM-Motorservice Article no.:	
	LBS 21250FA	LB 21250 F (phosphated)	KBS 21250 A	KB 21250 A	KR 21250	PB 21250	

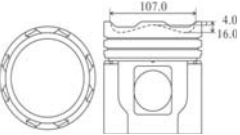

ENGINE TYPE Motortyp/ tipo de motor/ тип двигателя	LINER KIT Liner Kit/ camisas de los cilindros/ Лайнер комплект	CYL. LINER Zylinderlaufbuchse/ camisas de los cilindros/ втулка цилиндра	PISTON + RINGS Kolben + Ringe/ Pistón + Anillos/ поршень и кольца	PISTON SET Kolben Set/ Pistón Set/ поршневой	RINGS SET Ring Set/ Anillos Set/ кольца	PIN Pin/ Perno/ Пин	
S6D125 11,040 cc 6 cyl 125.0 mm Bore Ø		Liner/ Sleeve	Piston		Rings		
		Length: Outside Ø: Flange Ø: Flange depth:	256.5 141.4 153.0 10.0 +2.0	Length: Comp. height:	117.4 80.4 -14.5 -25.8	Top: 2nd: oil:	2.4 2.4 4.0
		Reference no.:	Reference no.:	Reference no.:	Reference no.:	Reference no.:	
		6150-21-2221 6151-22-2220	O-Ring: 6150-21-2230 6150-21-2240 6150-21-2250	6151-31-2012 6151-31-2710	6150-31-2032 6150-31-2033	6150-31-3130	
NM-Motorservice Article no./ Artikelnummer/ Modelo número/ статья номер	NM-Motorservice Article no.:	NM-Motorservice Article no.:	NM-Motorservice Article no.:	NM-Motorservice Article no.:	NM-Motorservice Article no.:	NM-Motorservice Article no.:	
	LBS 21300 FA	LB 21300 F (phosphated)	KBS 21300 A	KB 21300 A	KR 21300	PB 21300	

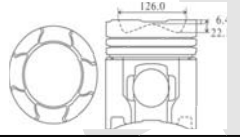

ENGINE TYPE Motortyp/ tipo de motor/ тип двигателя	LINER KIT Liner Kit/ camisas de los cilindros/ Лайнер комплект	CYL. LINER Zylinderlaufbuchse/ camisas de los cilindros/ втулка цилиндра	PISTON + RINGS Kolben + Ringe/ Pistón + Anillos/ поршень и кольца	PISTON SET Kolben Set/ Pistón Set/ поршневой	RINGS SET Ring Set/ Anillos Set/ кольца	PIN Pin/ Perno/ Пин	
4D130 8,490 cc 4 cyl 130.0 mm Bore Ø		Liner/ Sleeve	Piston		Rings		
		Length: Outside Ø: Flange Ø: Flange depth:	293.0 146.0 156.0 13.0 +1.0	Length: Comp. height:	135.0 90.0 -4.0 -6.9	Top: 2nd: oil:	3.5 2.5 5.5
		Reference no.:	Reference no.:	Reference no.:	Reference no.:	Reference no.:	
		6115-21-2211	6610-21-2221 6610-21-2240 6610-21-2250	6114-31-2111 6115-31-2112	6114-30-2303 6114-30-2403	6110-33-3120	
NM-Motorservice Article no./ Artikelnummer/ Modelo número/ статья номер	NM-Motorservice Article no.:	NM-Motorservice Article no.:	NM-Motorservice Article no.:	NM-Motorservice Article no.:	NM-Motorservice Article no.:	NM-Motorservice Article no.:	
	LBS 21350 FA	LB 21350 F (phosphated)	KBS 21350 A	KB 21350 A	KR 21350	PB 21350	

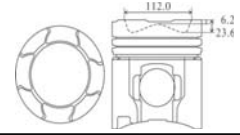

ENGINE TYPE Motortyp/ tipo de motor/ тип двигателя	LINER KIT Liner Kit/ camisas de los cilindros/ Лайнер комплект	CYL. LINER Zylinderlaufbuchse/ camisas de los cilindros/ втулка цилиндра	PISTON + RINGS Kolben + Ringe/ Pistón + Anillos/ поршень и кольца	PISTON SET Kolben Set/ Pistón Set/ поршневой	RINGS SET Ring Set/ Anillos Set/ кольца	PIN Pin/ Perno/ Пин	
SA6D155 19,260 cc 6 cyl 155.0 mm Bore Ø		Liner/ Sleeve	Piston		Rings		
		Length: Outside Ø: Flange Ø: Flange depth:	327.0 186.0 176.0 14.3 +1.5	Length: Comp. height:	170.0 105.0 -5.2 -23.3	Top: 2nd: oil:	3.7 3.57 4.76
		Reference no.:	Reference no.:	Reference no.:	Reference no.:	Reference no.:	
		6128-21-2222	O-Ring: 6127-21-2221 6127-21-2241 6127-21-2252	6128-31-2050 6128-31-2140	6128-31-2060 6128-31-2070	6127-31-3131	
NM-Motorservice Article no./ Artikelnummer/ Modelo número/ статья номер	NM-Motorservice Article no.:	NM-Motorservice Article no.:	NM-Motorservice Article no.:	NM-Motorservice Article no.:	NM-Motorservice Article no.:	NM-Motorservice Article no.:	
	LBS 21400 FA	LB 21400 F (phosphated)	KBS 21400 A	KB 21400 A	KR 21400	PB 21400	

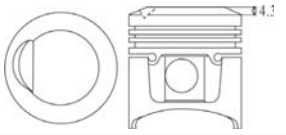

ENGINE TYPE Motortyp/ tipo de motor/ тип двигателя	LINER KIT Liner Kit/ camisas de los cilindros/ Лайнер комплект	CYL. LINER Zylinderlaufbuchse/ camisas de los cilindros/ втулка цилиндра	PISTON + RINGS Kolben + Ringe/ Pistón + Anillos/ поршень и кольца	PISTON SET Kolben Set/ Pistón Set/ поршневой	RINGS SET Ring Set/ Anillos Set/ кольца	PIN Pin/ Perno/ Пин
S6D155 19,260 cc 6 cyl 155.0 mm Bore Ø		Liner/ Sleeve	Piston		Rings	Ø : 60.0 Length: 130.0
		Length: 327.0 Outside Ø: 186.0 Flange Ø: 176.0 Flange depth: 14.0 +2.0	Length: 167.5 Comp. height: 102.5 -4.0 -16.0		Top: 3.7 2nd: 3.57 oil: 4.76	
		Reference no.:	Reference no.:	Reference no.:	Reference no.:	Reference no.:
		6128-21-2216	O-Ring: 6127-21-2221 6127-21-2241 6127-21-2252	6127-31-2030 6127-31-2140	6128-31-2060 6128-31-2070	6127-31-3131
NM-Motorservice Article no./ Artikelnummer/ Modelo número/ статья номер	NM-Motorservice Article no.:	NM-Motorservice Article no.:	NM-Motorservice Article no.:	NM-Motorservice Article no.:	NM-Motorservice Article no.:	NM-Motorservice Article no.:
	LBS 21450 FA	LB 21450 F (phosphated)	KBS 21450 A	KB 21450 A	KR 21450	PB 21450

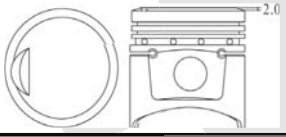

ENGINE TYPE Motortyp/ tipo de motor/ тип двигателя	LINER KIT Liner Kit/ camisas de los cilindros/ Лайнер комплект	CYL. LINER Zylinderlaufbuchse/ camisas de los cilindros/ втулка цилиндра	PISTON + RINGS Kolben + Ringe/ Pistón + Anillos/ поршень и кольца	PISTON SET Kolben Set/ Pistón Set/ поршневой	RINGS SET Ring Set/ Anillos Set/ кольца	PIN Pin/ Perno/ Пин
SV6D170 23,150 cc 6 cyl 170.0 mm Bore Ø		Liner/ Sleeve	Piston	Pistons are alfin and with oil gallery head anodized	Rings	Ø : 68.0 Length: 142.0
		Length: 342.0 Outside Ø: 190.3 Flange Ø: 206.0 Flange depth: 14.0 +2.0	Length: 195.6 Comp. height: 120.6 -6.4 -22.1		Top: 3.7 2nd: 3.55 oil: 4.75	
		Reference no.:	Reference no.:	Reference no.:	Reference no.:	Reference no.:
		6162-23-2210 6162-25-2210	O-Ring: 6162-23-2220 6162-23-2240 6162-23-2250	6164-31-2110	6162-33-2060	6162-33-3131
NM-Motorservice Article no./ Artikelnummer/ Modelo número/ статья номер	NM-Motorservice Article no.:	NM-Motorservice Article no.:	NM-Motorservice Article no.:	NM-Motorservice Article no.:	NM-Motorservice Article no.:	NM-Motorservice Article no.:
	LBS 45350 FB	LB 45350 F (phosphated)	KBS 45350 B	KB 45350 B	KR 45350	PB 45350

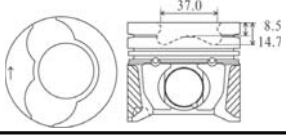

ENGINE TYPE Motortyp/ tipo de motor/ тип двигателя	LINER KIT Liner Kit/ camisas de los cilindros/ Лайнер комплект	CYL. LINER Zylinderlaufbuchse/ camisas de los cilindros/ втулка цилиндра	PISTON + RINGS Kolben + Ringe/ Pistón + Anillos/ поршень и кольца	PISTON SET Kolben Set/ Pistón Set/ поршневой	RINGS SET Ring Set/ Anillos Set/ кольца	PIN Pin/ Perno/ Пин
S6D170 23,150 cc 6 cyl 170.0 mm Bore Ø		Liner/ Sleeve	Piston	Alfin head anodized	Rings	Ø : 68.0 Length: 142.0
		Length: 342.0 Outside Ø: 190.3 Flange Ø: 206.0 Flange depth: 14.0 +2.0	Length: 195.6 Comp. height: 120.6 6.2 -23.6		Top: 3.7 2nd: 3.55 oil: 4.75	
		Reference no.:	Reference no.:	Reference no.:	Reference no.:	Reference no.:
		6162-23-2210 6162-25-2210	O-Ring: 6162-23-2220 6162-23-2240 6162-23-2250	6162-33-2120	6162-33-2060	6162-33-3131
NM-Motorservice Article no./ Artikelnummer/ Modelo número/ статья номер	NM-Motorservice Article no.:	NM-Motorservice Article no.:	NM-Motorservice Article no.:	NM-Motorservice Article no.:	NM-Motorservice Article no.:	NM-Motorservice Article no.:
	LBS 21500 FA	LB 21500 F (phosphated)	KBS 21500 A	KB 21500 A	KR 21500	PB 21500

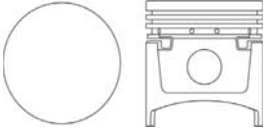

ENGINE TYPE Motortyp/ tipo de motor/ тип двигателя	LINER KIT Liner Kit/ camisas de los cilindros/ Лайнер комплект	CYL. LINER Zylinderlaufbuchse/ camisas de los cilindros/ втулка цилиндра		PISTON + RINGS Kolben + Ringe/ Pistón + Anillos/ поршень и кольца		PISTON SET Kolben Set/ Pistón Set/ поршневой	RINGS SET Ring Set/ Anillos Set/ кольца		PIN Pin/ Perno/ Пин	
PB 987 cc 4 cyl 68.0 mm Bore Ø			Liner/ Sleeve	Piston			Rings		Ø: Length:	20.0 56.0
		Length: Outside Ø: Flange Ø: Flange depth:	125.0 77.0 88.0 8.5	Length: Comp. height:	73.9 37.6 +4.3		Top: 2nd: oil:	2.0 2.0 4.0		
		Reference no.:			Reference no.:	Reference no.:	Reference no.:		Reference no.:	
		0249-10-311			0249-11-102 0249-99-111 0259-23-200	0249-23-170A 0249-23-206 0259-23-170 0259-23-170A 0259-23-206 0259-23-260	0249-11-213			
NM-Motorservice Article no./ Artikelnummer/ Modelo número/ статья номер	NM-Motorservice Article no.:	NM-Motorservice Article no.:		NM-Motorservice Article no.:		NM-Motorservice Article no.:	NM-Motorservice Article no.:		NM-Motorservice Article no.:	
	LBS 21600 F	LB 21600 F		KBS 21600 G		KB 21600 G	KR 21600 G		PB 21600 G	



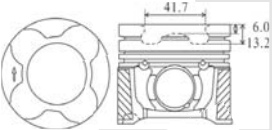

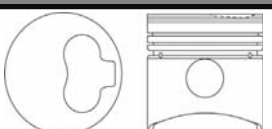

ENGINE TYPE Motortyp/ tipo de motor/ тип двигателя	LINER KIT Liner Kit/ camisas de los cilindros/ Лайнер комплект	CYL. LINER Zylinderlaufbuchse/ camisas de los cilindros/ втулка цилиндра		PISTON + RINGS Kolben + Ringe/ Pistón + Anillos/ поршень и кольца		PISTON SET Kolben Set/ Pistón Set/ поршневой	RINGS SET Ring Set/ Anillos Set/ кольца		PIN Pin/ Perno/ Пин	
TB 1,139 cc 4 cyl 70.0 mm Bore Ø			Liner/ Sleeve	Piston			Rings		Ø: Length:	
		Length: Outside Ø: Flange Ø: Flange depth:	132.0 77.0 88.0 8.5	Length: Comp. height:	71.0 37.0 +2.0		Top: 2nd: oil:	2.0 2.0 4.0		
		Reference no.:			Reference no.:	Reference no.:	Reference no.:		Reference no.:	
		0268-10-311 0271-23-206			0268-11-102 0268-23-200 0271-23-200	0211-23-999 0268-23-170 0268-23-170A 0268-23-206 0317-23-130 0317-23-175	0249-11-213			
NM-Motorservice Article no./ Artikelnummer/ Modelo número/ статья номер	NM-Motorservice Article no.:	NM-Motorservice Article no.:		NM-Motorservice Article no.:		NM-Motorservice Article no.:	NM-Motorservice Article no.:		NM-Motorservice Article no.:	
	LBS 44050 F	LB 44050 F		KBS 44050 G		KB 44050 G	KR 44050 G		PB 44050 G	

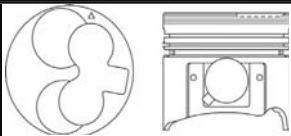

ENGINE TYPE Motortyp/ tipo de motor/ тип двигателя	LINER KIT Liner Kit/ camisas de los cilindros/ Лайнер комплект	CYL. LINER Zylinderlaufbuchse/ camisas de los cilindros/ втулка цилиндра		PISTON + RINGS Kolben + Ringe/ Pistón + Anillos/ поршень и кольца		PISTON SET Kolben Set/ Pistón Set/ поршневой	RINGS SET Ring Set/ Anillos Set/ кольца		PIN Pin/ Perno/ Пин		
Y4 CDi (MZ-CD) also for FORD PSA 1,399 cc 4 cyl 73.7 mm Bore Ø			Flanged	No flange	Piston		Alfin skirt MOS2 treated	Rings		Ø: Length:	25.0 60.0
		Length: Outside Ø: Flange Ø: Flange depth:	137.0 76.78 78.7 4.0	137.0 76.78	Length: Comp. height:	65.44 42.94 -8.5 -14.7		Top: 2nd: oil:	2.5 1.95 2.5		
		Reference no.:			Reference no.:	Reference no.:	Reference no.:	Reference no.:		Reference no.:	
					Y401-11-100		Y401-11-SCO				
NM-Motorservice Article no./ Artikelnummer/ Modelo número/ статья номер	NM-Motorservice Article no.:	NM-Motorservice Article no.:		NM-Motorservice Article no.:		NM-Motorservice Article no.:	NM-Motorservice Article no.:		NM-Motorservice Article no.:		
	LBS 57500 PA LBS 57500 SA	LB 57500 P LB 57500 S		KBS 57500 A		KB 57500 A	KR 57500		PB 57500		

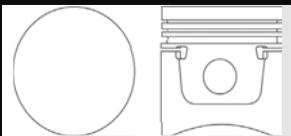

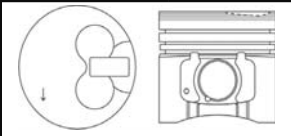
ENGINE TYPE Motortyp/ tipo de motor/ тип двигателя	LINER KIT Liner Kit/ camisas de los cilindros/ Лайнер комплект	CYL. LINER Zylinderlaufbuchse/ camisas de los cilindros/ втулка цилиндра		PISTON + RINGS Kolben + Ringe/ Pistón + Anillos/ поршень и кольца		PISTON SET Kolben Set/ Pistón Set/ поршневой	RINGS SET Ring Set/ Anillos Set/ кольца		PIN Pin/ Perno/ Пин	
UA 1,484 cc 4 cyl 75.0 mm Bore Ø			Liner/ Sleeve	Piston			Rings		Ø : Length:	22.0 65.0
		Length: Outside Ø: Flange Ø: Flange depth:	147.5 86.5 94.0 9.0		Length: Comp. height:		78.0 41.0 +0	Top: 2nd: oil:		
		Reference no.:				Reference no.:	Reference no.:	Reference no.:		
		0604-10-311				0107-11-102 0603-23-200	0603-23-170 0603-23-170A 0603-23-999	0107-11-212 0170-11-212		
NM-Motorservice Article no./ Artikelnummer/ Modelo número/ статья номер	NM-Motorservice Article no.:	NM-Motorservice Article no.:		NM-Motorservice Article no.:		NM-Motorservice Article no.:	NM-Motorservice Article no.:	NM-Motorservice Article no.:		
	LBS 21750 F	LB 21750 F		KBS 21750 G		KB 21750 G	KR 21750 G	PB 21750G		

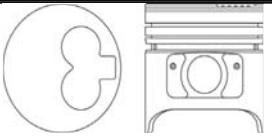

ENGINE TYPE Motortyp/ tipo de motor/ тип двигателя	LINER KIT Liner Kit/ camisas de los cilindros/ Лайнер комплект	CYL. LINER Zylinderlaufbuchse/ camisas de los cilindros/ втулка цилиндра		PISTON + RINGS Kolben + Ringe/ Pistón + Anillos/ поршень и кольца		PISTON SET Kolben Set/ Pistón Set/ поршневой	RINGS SET Ring Set/ Anillos Set/ кольца		PIN Pin/ Perno/ Пин	
Y6 CDi (MZ-CD) also for FORD PSA 1,560 cc 4 cyl 75.0 mm Bore Ø			Flanged	No flange	Piston		Rings		Ø : Length:	26.0 61.0
		Length: Outside Ø: Flange Ø: Flange depth:	146.0 78.0 79.0 4.0	146.0 78.0	Length: Comp. height:	65.3 41.7 -6.0 -13.2	Alfin and with oil gallery skirt MOS2 treated	Top: 2nd: oil:		
		Reference no.:				Reference no.:	Reference no.:	Reference no.:		
						Y601-11-100	Y601-11-SCO			
NM-Motorservice Article no./ Artikelnummer/ Modelo número/ статья номер	NM-Motorservice Article no.:	NM-Motorservice Article no.:		NM-Motorservice Article no.:		NM-Motorservice Article no.:	NM-Motorservice Article no.:	NM-Motorservice Article no.:		
	LBS 58500 PB LBS 58500 SB	LB 58500 P LB 58500 S		KBS 58500 B		KB 58500 B	KR 58500	PB 58500		

ENGINE TYPE Motortyp/ tipo de motor/ тип двигателя	LINER KIT Liner Kit/ camisas de los cilindros/ Лайнер комплект	CYL. LINER Zylinderlaufbuchse/ camisas de los cilindros/ втулка цилиндра		PISTON + RINGS Kolben + Ringe/ Pistón + Anillos/ поршень и кольца		PISTON SET Kolben Set/ Pistón Set/ поршневой	RINGS SET Ring Set/ Anillos Set/ кольца		PIN Pin/ Perno/ Пин	
PN 1,720 cc 4 cyl 78.0 mm Bore Ø			Flanged	No flange	Piston		Rings		Ø : Length:	25.0 64.0
		Length: Outside Ø: Flange Ø: Flange depth:	157.0 82.0 86.0 2.0	155.0 82.0	Length: Comp. height:	76.1 41.3 -2.8		Top: 2nd: oil:		
		Reference no.:				Reference no.:	Reference no.:	Reference no.:		
		PN11-11-311				PN11-11-SAOB PN20-11-SAO PN20-11-SBX	PN11-11-SCO PNY2-11-SCO PNY2-11-SCOA	PN11-11-213		
NM-Motorservice Article no./ Artikelnummer/ Modelo número/ статья номер	NM-Motorservice Article no.:	NM-Motorservice Article no.:		NM-Motorservice Article no.:		NM-Motorservice Article no.:	NM-Motorservice Article no.:	NM-Motorservice Article no.:		
	LBS 21850 P LBS 21850 S	LB 21850 P LB 21850 S		KBS 21850		KB 21850	KR 21850	PB 21850		

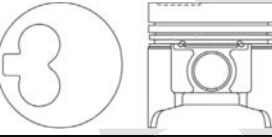
ENGINE TYPE Motortyp/ tipo de motor/ тип двигателя	LINER KIT Liner Kit/ camisas de los cilindros/ Лайнер комплект	CYL. LINER Zylinderlaufbuchse/ camisas de los cilindros/ втулка цилиндра		PISTON + RINGS Kolben + Ringe/ Pistón + Anillos/ поршень и кольца	PISTON SET Kolben Set/ Pistón Set/ поршневой	RINGS SET Ring Set/ Anillos Set/ кольца	PIN Pin/ Perno/ Пин
323 1.7 TD			Flanged	No flange	Piston	Rings	Ø : 27.0 Length: 64.0
		Length: 144.0 Outside Ø: 83.0 Flange Ø: 87.0 Flange depth: 2.0					
1,686 cc 4 cyl 79.0 mm Bore Ø							
							
NM-Motorservice Article no./ Artikelnummer/ Modelo número/ статья номер	NM-Motorservice Article no.:	NM-Motorservice Article no.:		NM-Motorservice Article no.:	NM-Motorservice Article no.:	NM-Motorservice Article no.:	NM-Motorservice Article no.:
	LBS 21900 PA LBS 21900 SA	LB 21900 P LB 21900 S		KBS 21900 A	KB 21900 A	KR 21900	PB 21900
VA			Liner/ Sleeve		Piston	Rings	Ø : 22.0 Length: 71.0
		Length: 168.5 Outside Ø: 90.0 Flange Ø: 98.0 Flange depth: 9.0					
1,985 cc 4 cyl 82.0 mm Bore Ø							
							
NM-Motorservice Article no./ Artikelnummer/ Modelo número/ статья номер	NM-Motorservice Article no.:	NM-Motorservice Article no.:		NM-Motorservice Article no.:	NM-Motorservice Article no.:	NM-Motorservice Article no.:	NM-Motorservice Article no.:
	LBS 96780 F	LB 96780 F		KBS 96780 G	KB 96780 G	KR 96780 G	PB 96780 G
RTE/ RTF			Flanged	No flange	Piston	Rings	Ø : 26.0 Length: 59.0
		Length: 162.5 Outside Ø: 86.5 Flange Ø: 90.5 Flange depth: 4.0					
121 1.8 D 1,753 cc 4 cyl 82.5 mm Bore Ø							
							
NM-Motorservice Article no./ Artikelnummer/ Modelo número/ статья номер	NM-Motorservice Article no.:	NM-Motorservice Article no.:		NM-Motorservice Article no.:	NM-Motorservice Article no.:	NM-Motorservice Article no.:	NM-Motorservice Article no.:
	LBS 22350 FA LBS 22350 SA LBS 22350 PA	LB 22350 F LB 22350 S LB 22350 P		KBS 22350 A	KB 22350 A	KR 22350	PB 22350

ENGINE TYPE Motortyp/ tipo de motor/ тип двигателя	LINER KIT Liner Kit/ camisas de los cilindros/ Лайнер комплект	CYL. LINER Zylinderlaufbuchse/ camisas de los cilindros/ втулка цилиндра		PISTON + RINGS Kolben + Ringe/ Pistón + Anillos/ поршень и кольца		PISTON SET Kolben Set/ Pistón Set/ поршневой	RINGS SET Ring Set/ Anillos Set/ кольца		PIN Pin/ Perno/ Пин	
R2 also for FORD RF 2,184 cc 4 cyl 86.0 mm Bore Ø	LBS 22050 F LBS 22050 S LBS 22050 P LBS 22050 FA LBS 22050 SA LBS 22050 PA with affin pistons		Flanged	No flange	Piston		Rings			
		Length: Outside Ø: Flange Ø: Flange depth:	165.0 89.0 94.0 4.0	165.0 90.0	Length: Comp. height:	86.3 47.3 -1.6	Top: 2nd: oil:	2.0 2.0 4.0	Ø: Length:	25.0 68.5
		Reference no.:			Reference no.:		Reference no.:		Reference no.:	
		R201-23-051 RF01-10-311			RF01-23-200 RF01-23-200B		R201-23-130A R201-23-130B		RF01-11-213	
NM-Motorservice Article no./ Artikelnummer/ Modelo número/ статья номер	NM-Motorservice Article no.:	NM-Motorservice Article no.:		NM-Motorservice Article no.:		NM-Motorservice Article no.:	NM-Motorservice Article no.:		NM-Motorservice Article no.:	
	LBS 22050 F LBS 22050 S LBS 22050 P	LB 22050 F LB 22050 S LB 22050 P		KBS 22050 KBS 22050 A		KB 22050 KB 22050 A	KR 22050		PB 22050	

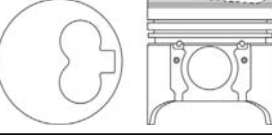

ENGINE TYPE Motortyp/ tipo de motor/ тип двигателя	LINER KIT Liner Kit/ camisas de los cilindros/ Лайнер комплект	CYL. LINER Zylinderlaufbuchse/ camisas de los cilindros/ втулка цилиндра		PISTON + RINGS Kolben + Ringe/ Pistón + Anillos/ поршень и кольца		PISTON SET Kolben Set/ Pistón Set/ поршневой	RINGS SET Ring Set/ Anillos Set/ кольца		PIN Pin/ Perno/ Пин	
R2 2,184 cc 4 cyl 86.0 mm Bore Ø			Flanged	No flange	Piston		Rings			
		Length: Outside Ø: Flange Ø: Flange depth:	163.0 89.0 94.0 2.8	163.0 90.0	Length: Comp. height:	86.2 47.2 -1.5	Alfin and with oil gallery	Top: 2nd: oil:	2.0 2.0 3.0	Ø: Length:
		Reference no.:			Reference no.:		Reference no.:		Reference no.:	
		R2B6-10-311 R2B6-10-313			R2Y0-11-SAO		R2B6-11-SCO RF2A-11-SCO RFY5-11-SCOA RFY5-11-SDOA RFY5-11-SXOA		RF01-11-213	
NM-Motorservice Article no./ Artikelnummer/ Modelo número/ статья номер	NM-Motorservice Article no.:	NM-Motorservice Article no.:		NM-Motorservice Article no.:		NM-Motorservice Article no.:	NM-Motorservice Article no.:		NM-Motorservice Article no.:	
	LBS 22100 FB LBS 22100 SB LBS 22100 PB	LB 22100 F LB 22100 S LB 22100 P		KBS 22100 B		KB 22000 B	KR 22100		PB 22100	



ENGINE TYPE Motortyp/ tipo de motor/ тип двигателя	LINER KIT Liner Kit/ camisas de los cilindros/ Лайнер комплект	CYL. LINER Zylinderlaufbuchse/ camisas de los cilindros/ втулка цилиндра		PISTON + RINGS Kolben + Ringe/ Pistón + Anillos/ поршень и кольца		PISTON SET Kolben Set/ Pistón Set/ поршневой	RINGS SET Ring Set/ Anillos Set/ кольца		PIN Pin/ Perno/ Пин	
RF 1,998 cc 4 cyl 86.0 mm Bore Ø			Flanged	No flange	Piston		Rings			
		Length: Outside Ø: Flange Ø: Flange depth:	165.0 89.0 94.0 4.0	165.0 90.0	Length: Comp. height:	86.3 47.3 -1.5	Top: 2nd: oil:	2.0 2.0 4.0	Ø: Length:	30.0 68.0
		Reference no.:			Reference no.:		Reference no.:		Reference no.:	
		R201-23-051 RF01-10-311			RFY0-11-SAO RFY0-11-SAOA		R201-23-130A R201-23-130B		RF5C-11-123 RF71-11-213 RF71-11-213A	
NM-Motorservice Article no./ Artikelnummer/ Modelo número/ статья номер	NM-Motorservice Article no.:	NM-Motorservice Article no.:		NM-Motorservice Article no.:		NM-Motorservice Article no.:	NM-Motorservice Article no.:		NM-Motorservice Article no.:	
	LBS 22150 FA LBS 22150 SA LBS 22150 PA	LB 22150 F LB 22150 S LB 22150 P		KBS 22150 A		KB 22150 A	KR 22150		PB 22150	

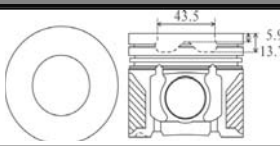

ENGINE TYPE Motortyp/ tipo de motor/ тип двигателя	LINER KIT Liner Kit/ camisas de los cilindros/ Лайнер комплект	CYL. LINER Zylinderlaufbuchse/ camisas de los cilindros/ втулка цилиндра		PISTON + RINGS Kolben + Ringe/ Pistón + Anillos/ поршень и кольца		PISTON SET Kolben Set/ Pistón Set/ поршневой	RINGS SET Ring Set/ Anillos Set/ кольца		PIN Pin/ Perno/ Пин	
RF New 1,998 cc 4 cyl 86.0 mm Bore Ø			Flanged	No flange	Piston		Alfin and with oil gallery	Rings		Ø : 30.0 Length: 68.0
		Length: Outside Ø: Flange Ø: Flange depth:	163.0 89.0 94.0 2.8	163.0 90.0	Length: Comp. height:	86.2 47.2 -1.2 -3.1		Top: 2nd: oil:	2.0 2.0 3.0	
		Reference no.:				Reference no.:	Reference no.:	Reference no.:		
		R2B6-10-311 R2B6-10-313				RFY4-11-SA0A	RFY2-11-SCO RFYO-11-SCO	RF5C-11-123 RF71-11-213 RF71-11-213A		
NM-Motorservice Article no./ Artikelnummer/ Modelo número/ статья номер		NM-Motorservice Article no.:		NM-Motorservice Article no.:		NM-Motorservice Article no.:	NM-Motorservice Article no.:	NM-Motorservice Article no.:		
		LBS 22200 FB LBS 22200 SB LBS 22200 PB		LB 22200 F LB 22200 S LB 22200 P		KBS 22200 B	KB 22200 B	KR 22200		PB 22200



ENGINE TYPE Motortyp/ tipo de motor/ тип двигателя	LINER KIT Liner Kit/ camisas de los cilindros/ Лайнер комплект	CYL. LINER Zylinderlaufbuchse/ camisas de los cilindros/ втулка цилиндра		PISTON + RINGS Kolben + Ringe/ Pistón + Anillos/ поршень и кольца		PISTON SET Kolben Set/ Pistón Set/ поршневой	RINGS SET Ring Set/ Anillos Set/ кольца		PIN Pin/ Perno/ Пин	
R2 New 2,184 cc 4 cyl 86.0 mm Bore Ø			Flanged	No flange	Piston		Alfin and with oil gallery	Rings		Ø : 25.0 Length: 64.0
		Length: Outside Ø: Flange Ø: Flange depth:	163.0 89.0 94.0 2.8	163.0 90.0	Length: Comp. height:	82.2 43.2 -1.2 -2.2		Top: 2nd: oil:	2.0 2.0 3.0	
		Reference no.:				Reference no.:	Reference no.:	Reference no.:		
		R2B6-10-311 R2B6-10-313				R2Y3-11-SA0B	R2B6-11-SCO RF2A-11-SCO RFY5-11-SCOA RFY5-11-SDOA RFY5-11-SXOA	RF01-11-213		
NM-Motorservice Article no./ Artikelnummer/ Modelo número/ статья номер		NM-Motorservice Article no.:		NM-Motorservice Article no.:		NM-Motorservice Article no.:	NM-Motorservice Article no.:	NM-Motorservice Article no.:		
		LBS 22250 FB LBS 22250 SB LBS 22250 PB		LB 22250 F LB 22250 S LB 22250 P		KBS 22250 B	KB 22250 B	KR 22000		PB 22250

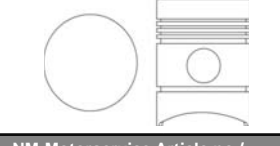

ENGINE TYPE Motortyp/ tipo de motor/ тип двигателя	LINER KIT Liner Kit/ camisas de los cilindros/ Лайнер комплект	CYL. LINER Zylinderlaufbuchse/ camisas de los cilindros/ втулка цилиндра		PISTON + RINGS Kolben + Ringe/ Pistón + Anillos/ поршень и кольца		PISTON SET Kolben Set/ Pistón Set/ поршневой	RINGS SET Ring Set/ Anillos Set/ кольца		PIN Pin/ Perno/ Пин	
RF2 PREMACY 1,998 cc 4 cyl 86.0 mm Bore Ø			Flanged	No flange	Piston		Alfin and with oil gallery	Rings		Ø : 30.0 Length: 68.0
		Length: Outside Ø: Flange Ø: Flange depth:	155.0 90.0 93.0 4.0	155.0 90.0	Length: Comp. height:	85.8 46.8 -4.8 -15.8		Top: 2nd: oil:	2.0 2.0 3.0	
		Reference no.:				Reference no.:	Reference no.:	Reference no.:		
						RFY2-11-SA0 RFY2-11-SA0A RFY2-11-SBXA RFY2-11-SB0 RFY2-11-SB0A RFY2-11-SBX	R2B6-11-SCO RF2A-11-SCO RFY5-11-SCOA RFY5-11-SDOA RFY5-11-SXOA	RF5C-11-213 RF71-11-213 RF71-11-213A		
NM-Motorservice Article no./ Artikelnummer/ Modelo número/ статья номер		NM-Motorservice Article no.:		NM-Motorservice Article no.:		NM-Motorservice Article no.:	NM-Motorservice Article no.:	NM-Motorservice Article no.:		
		LBS 22300 FB LBS 22300 SB LBS 22300 PB		LB 22300 F LB 22300 S LB 22300 P		KBS 22300 B	KB 22300 B	KR 22000		PB 22300

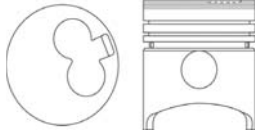

ENGINE TYPE Motor/typo/ tipo de motor/ тип двигателя	LINER KIT Liner Kit/ camisas de los cilindros/ Лайнер комплект	CYL. LINER Zylinderlaufbuchse/ camisas de los cilindros/ втулка цилиндра	PISTON + RINGS Kolben + Ringe/ Pistón + Anillos/ поршень и кольца		PISTON SET Kolben Set/ Pistón Set/ поршневой	RINGS SET Ring Set/ Anillos Set/ кольца	PIN Pin/ Perno/ Пин
RF7 (MZR-CD 16V) 2002- 1,998 cc 4 cyl 86.0 mm Bore Ø			Flanged	No flange	Piston	Rings	
		Length: 163.0 Outside Ø: 89.0 Flange Ø: 94.0 Flange depth: 2.8	163.0 90.0	Length: 75.8 Comp. height: 46.8 -5.9 -13.7			
		Reference no.:			Reference no.:	Reference no.:	Reference no.:
		R2B6-10-311 R2B6-10-313			RFY7-11-SAOA RFY7-11-SAOB RFY7-11-SBOA RFY7-11-SBOB RFY7-11-SBXA RFY7-11-SBXB	R2B6-11-SCO RF2A-11-SCO RFY5-11-SCOA RFY5-11-SDOA RFY5-11-SXOA	RF5C-11-213 RF71-11-213 RF71-11-213A
NM-Motorservice Article no./ Artikelnummer/ Modelo número/ статья номер	NM-Motorservice Article no.:	NM-Motorservice Article no.:	NM-Motorservice Article no.:	NM-Motorservice Article no.:	NM-Motorservice Article no.:	NM-Motorservice Article no.:	NM-Motorservice Article no.:
	LBS 22000 FB LBS 22000 SB LBS 22000 PB	LB 22000 F LB 22000 S LB 22000 P	KBS 22000 B	KB 22000 B	KR 22000	PB 22000	

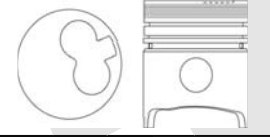

ENGINE TYPE Motor/typo/ tipo de motor/ тип двигателя	LINER KIT Liner Kit/ camisas de los cilindros/ Лайнер комплект	CYL. LINER Zylinderlaufbuchse/ camisas de los cilindros/ втулка цилиндра	PISTON + RINGS Kolben + Ringe/ Pistón + Anillos/ поршень и кольца		PISTON SET Kolben Set/ Pistón Set/ поршневой	RINGS SET Ring Set/ Anillos Set/ кольца	PIN Pin/ Perno/ Пин
RF8 (MZR-CD 16V) 2005- 1,998 cc 4 cyl 86.0 mm Bore Ø			Flanged	No flange	Piston	Rings	
		Length: 163.0 Outside Ø: 89.0 Flange Ø: 94.0 Flange depth: 2.8	163.0 90.0	Length: 75.8 Comp. height: 46.8 -6.4 -15.5			
		Reference no.:			Reference no.:	Reference no.:	Reference no.:
		R2B6-10-311 R2B6-10-313			RFY8-11-SAO RFY8-11-SBO RFY8-11-SBX	R2B6-11-SCO RF2A-11-SCO RFY5-11-SCOA RFY5-11-SDOA RFY5-11-SXOA	RF5C-11-123 RF71-11-213 RF71-11-213A
NM-Motorservice Article no./ Artikelnummer/ Modelo número/ статья номер	NM-Motorservice Article no.:	NM-Motorservice Article no.:	NM-Motorservice Article no.:	NM-Motorservice Article no.:	NM-Motorservice Article no.:	NM-Motorservice Article no.:	NM-Motorservice Article no.:
	LBS 22400 FB LBS 22400 SB LBS 22400 PB	LB 22400 F LB 22400 S LB 22400 P	KBS 22400 B	KB 22400 B	KR 22000	PB 22400	

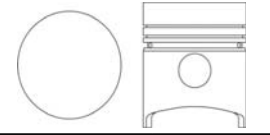

ENGINE TYPE Motor/typo/ tipo de motor/ тип двигателя	LINER KIT Liner Kit/ camisas de los cilindros/ Лайнер комплект	CYL. LINER Zylinderlaufbuchse/ camisas de los cilindros/ втулка цилиндра	PISTON + RINGS Kolben + Ringe/ Pistón + Anillos/ поршень и кольца		PISTON SET Kolben Set/ Pistón Set/ поршневой	RINGS SET Ring Set/ Anillos Set/ кольца	PIN Pin/ Perno/ Пин
XA E2500 2,522 cc 4 cyl 88.9 mm Bore Ø			Liner/ Sleeve		Piston	Rings	
		Length: 191.0 Outside Ø: 96.9 Flange Ø: 101.0 Flange depth: 3.8 +0.8		Length: 116.0 Comp. height: 60.6 +0			
		Reference no.:			Reference no.:	Reference no.:	Reference no.:
		0636-10-311 S501-23-051			0559-99-111 0559-23-200 0636-23-200 0750-23-200	0559-23-206 0559-23-207 0636-23-206 0636-23-207 0636-23-210	0636-11-213
NM-Motorservice Article no./ Artikelnummer/ Modelo número/ статья номер	NM-Motorservice Article no.:	NM-Motorservice Article no.:	NM-Motorservice Article no.:	NM-Motorservice Article no.:	NM-Motorservice Article no.:	NM-Motorservice Article no.:	NM-Motorservice Article no.:
	LBS 22450 F LBS 22450 S	LB 22450 F LB 22450 S	KBS 22450	KB 22450	KR 22450	PB 22450	

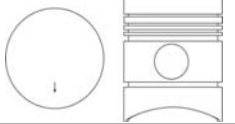

ENGINE TYPE Motortyp/ tipo de motor/ тип двигателя	LINER KIT Liner Kit/ camisas de los cilindros/ Лайнер комплект	CYL. LINER Zylinderlaufbuchse/ camisas de los cilindros/ втулка цилиндра		PISTON + RINGS Kolben + Ringe/ Pistón + Anillos/ поршень и кольца		PISTON SET Kolben Set/ Pistón Set/ поршневой	RINGS SET Ring Set/ Anillos Set/ кольца		PIN Pin/ Perno/ Пин	
S2 E2200			Liner/ Sleeve	Piston			Rings			
		Length: Outside Ø: Flange Ø: Flange depth:		Length: Comp. height:			Top: 2nd: oil:		Ø: Length:	
2,209 cc 4 cyl 88.9 mm Bore Ø		Reference no.:				Reference no.:	Reference no.:	Reference no.:		
		1456-23-051				1456-23-200 1456-23-200A 8259-23-200C	1456-23-206	0911-11-213 1456-11-213 S213-11-213		
NM-Motorservice Article no./ Artikelnummer/ Modelo número/ статья номер	NM-Motorservice Article no.:	NM-Motorservice Article no.:		NM-Motorservice Article no.:		NM-Motorservice Article no.:	NM-Motorservice Article no.:	NM-Motorservice Article no.:		NM-Motorservice Article no.:
	LBS 22500 F LBS 22500 S	LB 22500 F LB 22500 S		KBS 22500		KB 22500	KR 22500	PB 22500		



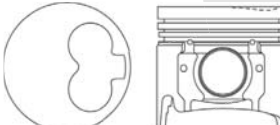

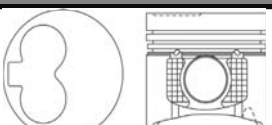

ENGINE TYPE Motortyp/ tipo de motor/ тип двигателя	LINER KIT Liner Kit/ camisas de los cilindros/ Лайнер комплект	CYL. LINER Zylinderlaufbuchse/ camisas de los cilindros/ втулка цилиндра		PISTON + RINGS Kolben + Ringe/ Pistón + Anillos/ поршень и кольца		PISTON SET Kolben Set/ Pistón Set/ поршневой	RINGS SET Ring Set/ Anillos Set/ кольца		PIN Pin/ Perno/ Пин	
XA T2500 S5 E2500			Liner/ Sleeve	Piston			Rings			
		Length: Outside Ø: Flange Ø: Flange depth:	191.0 96.9 101.1 3.8 +0.8		Length: Comp. height:		103.4 60.4 -1.8	Top: 2nd: oil:	2.38 2.38 4.76	Ø: Length:
2,522 cc 4 cyl 88.9 mm Bore Ø		Reference no.:				Reference no.:	Reference no.:	Reference no.:		
		0636-10-311 S501-23-051				S501-23-200 S501-99-111	1456-23-206	S501-11-213		
NM-Motorservice Article no./ Artikelnummer/ Modelo número/ статья номер	NM-Motorservice Article no.:	NM-Motorservice Article no.:		NM-Motorservice Article no.:		NM-Motorservice Article no.:	NM-Motorservice Article no.:	NM-Motorservice Article no.:		NM-Motorservice Article no.:
	LBS 22550 F LBS 22550 S	LB 22550 F LB 22550 S		KBS 22550		KB 22550	KR 22550	PB 22550		

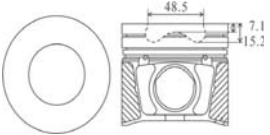

ENGINE TYPE Motortyp/ tipo de motor/ тип двигателя	LINER KIT Liner Kit/ camisas de los cilindros/ Лайнер комплект	CYL. LINER Zylinderlaufbuchse/ camisas de los cilindros/ втулка цилиндра		PISTON + RINGS Kolben + Ringe/ Pistón + Anillos/ поршень и кольца		PISTON SET Kolben Set/ Pistón Set/ поршневой	RINGS SET Ring Set/ Anillos Set/ кольца		PIN Pin/ Perno/ Пин	
XA E2500			Liner/ Sleeve	Piston			Rings			
		Length: Outside Ø: Flange Ø: Flange depth:	191.0 96.9 101.0 3.8 +0.8		Length: Comp. height:		103.3 60.3 +0	Top: 2nd: oil:	2.38 2.38 4.76	Ø: Length:
2,522 cc 4 cyl 88.9 mm Bore Ø		Reference no.:				Reference no.:	Reference no.:	Reference no.:		
		0636-10-311 S501-23-051				0911-99-111B	1456-23-206	S501-11-213		
NM-Motorservice Article no./ Artikelnummer/ Modelo número/ статья номер	NM-Motorservice Article no.:	NM-Motorservice Article no.:		NM-Motorservice Article no.:		NM-Motorservice Article no.:	NM-Motorservice Article no.:	NM-Motorservice Article no.:		NM-Motorservice Article no.:
	LBS 22600 F LBS 22600 S	LB 22600 F LB 22600		KBS 22600		KB 22600	KR 22600	PB 22600		

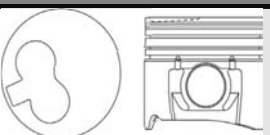

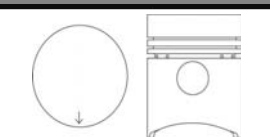
ENGINE TYPE Motortyp/ tipo de motor/ тип двигателя	LINER KIT Liner Kit/ camisas de los cilindros/ Лайнер комплект	CYL. LINER Zylinderlaufbuchse/ camisas de los cilindros/ втулка цилиндра	PISTON + RINGS Kolben + Ringe/ Pistón + Anillos/ поршень и кольца	PISTON SET Kolben Set/ Pistón Set/ поршневой	RINGS SET Ring Set/ Anillos Set/ кольца	PIN Pin/ Perno/ Пин	
XB E2700 2,701 cc 4 cyl 92.0 mm Bore Ø		Liner/ Sleeve	Piston		Rings		Ø : 31.75 Length: 75.0
		Length: Outside Ø: Flange Ø: Flange depth:	191.0 96.9 101.0 3.8 +0.8	Length: Comp. height:	115.7 60.2 +0	Top: 2nd: 3rd: 1st oil: 2nd oil:	
		Reference no.:		Reference no.:	Reference no.:	Reference no.:	
		0528-10-311 0527-23-051 0552-10-311		0528-23-200	0527-23-206 0528-23-206	0636-11-213	
NM-Motorservice Article no./ Artikelnummer/ Modelo número/ статья номер	NM-Motorservice Article no.:	NM-Motorservice Article no.:	NM-Motorservice Article no.:	NM-Motorservice Article no.:	NM-Motorservice Article no.:	NM-Motorservice Article no.:	
	LBS 22650 F LBS 22650 S	LB 22650 F LB 22650 S	KBS 22650	KB 22650	KR 22650	PB 22650	



ENGINE TYPE Motortyp/ tipo de motor/ тип двигателя	LINER KIT Liner Kit/ camisas de los cilindros/ Лайнер комплект	CYL. LINER Zylinderlaufbuchse/ camisas de los cilindros/ втулка цилиндра	PISTON + RINGS Kolben + Ringe/ Pistón + Anillos/ поршень и кольца	PISTON SET Kolben Set/ Pistón Set/ поршневой	RINGS SET Ring Set/ Anillos Set/ кольца	PIN Pin/ Perno/ Пин	
WL 2,499 cc 4 cyl 93.0 mm Bore Ø	Phosphated	Liner/ Sleeve	Piston		Rings		Ø : 32.0 Length: 70.0
		Length: Outside Ø: Flange Ø: Flange depth:	167.5 96.8 102.45 2.5 +0.5	Length: Comp. height:	87.4 47.9 -1.3 -3.2	Top: 2nd: oil:	
		Reference no.:		Reference no.:	Reference no.:	Reference no.:	
		WL01-10-311 WL01-23-051 WLY3-23-051		WLY3-11-SAOC WLY5-11-SAOB	WLY1-11-SCO	WL01-11-213	
NM-Motorservice Article no./ Artikelnummer/ Modelo número/ статья номер	NM-Motorservice Article no.:	NM-Motorservice Article no.:	NM-Motorservice Article no.:	NM-Motorservice Article no.:	NM-Motorservice Article no.:	NM-Motorservice Article no.:	
	LBS 22700 FA LBS 22700 SA	LB 22700 F (phosphated) LB 22700 S	KBS 22700 A	KB 22700 A	KR 22700	PB 22700	

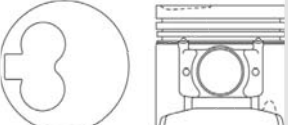

ENGINE TYPE Motortyp/ tipo de motor/ тип двигателя	LINER KIT Liner Kit/ camisas de los cilindros/ Лайнер комплект	CYL. LINER Zylinderlaufbuchse/ camisas de los cilindros/ втулка цилиндра	PISTON + RINGS Kolben + Ringe/ Pistón + Anillos/ поршень и кольца	PISTON SET Kolben Set/ Pistón Set/ поршневой	RINGS SET Ring Set/ Anillos Set/ кольца	PIN Pin/ Perno/ Пин		
WLT 2,499 cc 4 cyl 93.0 mm Bore Ø		Liner/ Sleeve	Piston		Alfin and with oil gallery	Rings		Ø : 32.0 Length: 69.8
		Length: Outside Ø: Flange Ø: Flange depth:	167.5 96.8 102.45 2.5 + 0.5	Length: Comp. height:		87.3 47.8 -2.0 -2.2	Top: 2nd: oil:	
		Reference no.:		Reference no.:	Reference no.:	Reference no.:		
		WL01-10-311 WL01-23-051 WLY3-23-051		WLY1-11-SAOA WLY8-11-SAOB	WLY1-11-SCO	WL01-11-213		
NM-Motorservice Article no./ Artikelnummer/ Modelo número/ статья номер	NM-Motorservice Article no.:	NM-Motorservice Article no.:	NM-Motorservice Article no.:	NM-Motorservice Article no.:	NM-Motorservice Article no.:	NM-Motorservice Article no.:		
	LBS 46000 FB LBS 46000 SB	LB 46000 F (Phosphated) LB 46000 S	KBS 46000 B	KB 46000 B	KR 46000	PB 46000		

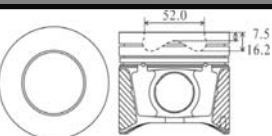

ENGINE TYPE Motortyp/ tipo de motor/ тип двигателя	LINER KIT Liner Kit/ camisas de los cilindros/ Лайнер комплект	CYL. LINER Zylinderlaufbuchse/ camisas de los cilindros/ втулка цилиндра	PISTON + RINGS Kolben + Ringe/ Pistón + Anillos/ поршень и кольца	PISTON SET Kolben Set/ Pistón Set/ поршневой	RINGS SET Ring Set/ Anillos Set/ кольца	PIN Pin/ Perno/ Пин																																																								
WL-C BT-50 2,499 cc 4 cyl 93.0 mm Bore Ø		<table border="1"> <tr> <td></td> <td>Liner/ Sleeve</td> <td></td> <td></td> <td></td> <td></td> </tr> <tr> <td>Length:</td> <td>167.5</td> <td></td> <td></td> <td></td> <td></td> </tr> <tr> <td>Outside Ø:</td> <td>96.8</td> <td></td> <td></td> <td></td> <td></td> </tr> <tr> <td>Flange Ø:</td> <td>102.45</td> <td></td> <td></td> <td></td> <td></td> </tr> <tr> <td>Flange depth:</td> <td>2.5 +0.5</td> <td></td> <td></td> <td></td> <td></td> </tr> </table>		Liner/ Sleeve					Length:	167.5					Outside Ø:	96.8					Flange Ø:	102.45					Flange depth:	2.5 +0.5					<table border="1"> <tr> <td></td> <td>Piston</td> </tr> <tr> <td>Length:</td> <td>81.2</td> </tr> <tr> <td>Comp. height:</td> <td>51.7 -7.1 -15.2</td> </tr> </table>		Piston	Length:	81.2	Comp. height:	51.7 -7.1 -15.2	Alfin and with oil gallery skirt MOS2 treated	<table border="1"> <tr> <td></td> <td colspan="2">Rings</td> <td></td> <td></td> </tr> <tr> <td>Top:</td> <td>2.0</td> <td>Ø:</td> <td>34.0</td> <td></td> </tr> <tr> <td>2nd:</td> <td>1.5</td> <td>Length:</td> <td>70.0</td> <td></td> </tr> <tr> <td>oil:</td> <td>2.0</td> <td></td> <td></td> <td></td> </tr> </table>		Rings				Top:	2.0	Ø:	34.0		2nd:	1.5	Length:	70.0		oil:	2.0				
			Liner/ Sleeve																																																											
		Length:	167.5																																																											
		Outside Ø:	96.8																																																											
		Flange Ø:	102.45																																																											
Flange depth:	2.5 +0.5																																																													
	Piston																																																													
Length:	81.2																																																													
Comp. height:	51.7 -7.1 -15.2																																																													
	Rings																																																													
Top:	2.0	Ø:	34.0																																																											
2nd:	1.5	Length:	70.0																																																											
oil:	2.0																																																													
Reference no.:		Reference no.:	Reference no.:	Reference no.:																																																										
WL01-10-311 WL01-23-051 WLY3-23-051		WLYE-11-SA0 WLYE-11-SB0 WLYE-11-SBX	WLY6-11-SC0 WLY6-11-SD0 WLY6-11-SDX	WE01-11-213 WE01-11-213A																																																										
NM-Motorservice Article no./ Artikelnummer/ Modelo número/ статья номер	NM-Motorservice Article no.:	NM-Motorservice Article no.:	NM-Motorservice Article no.:	NM-Motorservice Article no.:	NM-Motorservice Article no.:																																																									
	LBS 59500 FB LBS 59500 SB	LB 59500 F (phosphated) LB 59500 S	KBS 59500 B	KB 59500 B	KR 59500	PB 59500																																																								
JS K2700 2,665 cc 4 cyl 94.5 mm Bore Ø		<table border="1"> <tr> <td></td> <td>Liner/ Sleeve</td> <td></td> <td></td> <td></td> <td></td> </tr> <tr> <td>Length:</td> <td>166.0</td> <td></td> <td></td> <td></td> <td></td> </tr> <tr> <td>Outside Ø:</td> <td>97.47</td> <td></td> <td></td> <td></td> <td></td> </tr> <tr> <td>Flange Ø:</td> <td>104.2</td> <td></td> <td></td> <td></td> <td></td> </tr> <tr> <td>Flange depth:</td> <td>3.85 +0.5</td> <td></td> <td></td> <td></td> <td></td> </tr> </table>		Liner/ Sleeve					Length:	166.0					Outside Ø:	97.47					Flange Ø:	104.2					Flange depth:	3.85 +0.5					<table border="1"> <tr> <td></td> <td>Piston</td> </tr> <tr> <td>Length:</td> <td>81.7</td> </tr> <tr> <td>Comp. height:</td> <td>50.0 -1.9 -3.4</td> </tr> </table>		Piston	Length:	81.7	Comp. height:	50.0 -1.9 -3.4	Kolben Set/ Pistón Set/ поршневой	<table border="1"> <tr> <td></td> <td colspan="2">Rings</td> <td></td> <td></td> </tr> <tr> <td>Top:</td> <td>2.0</td> <td>Ø:</td> <td>30.0</td> <td></td> </tr> <tr> <td>2nd:</td> <td>2.0</td> <td>Length:</td> <td>76.0</td> <td></td> </tr> <tr> <td>oil:</td> <td>3.0</td> <td></td> <td></td> <td></td> </tr> </table>		Rings				Top:	2.0	Ø:	30.0		2nd:	2.0	Length:	76.0		oil:	3.0				
			Liner/ Sleeve																																																											
		Length:	166.0																																																											
		Outside Ø:	97.47																																																											
		Flange Ø:	104.2																																																											
Flange depth:	3.85 +0.5																																																													
	Piston																																																													
Length:	81.7																																																													
Comp. height:	50.0 -1.9 -3.4																																																													
	Rings																																																													
Top:	2.0	Ø:	30.0																																																											
2nd:	2.0	Length:	76.0																																																											
oil:	3.0																																																													
Reference no.:		Reference no.:	Reference no.:	Reference no.:																																																										
		K6Z1-11-SA0																																																												
NM-Motorservice Article no./ Artikelnummer/ Modelo número/ статья номер	NM-Motorservice Article no.:	NM-Motorservice Article no.:	NM-Motorservice Article no.:	NM-Motorservice Article no.:	NM-Motorservice Article no.:																																																									
	LBS 22850 FA LBS 22850 SA	LB 22850 F (phosphated) LB 22850 S	KBS 22850 A	KB 22850 A	KR 22850	PB 22850																																																								
HA E3000 2,977 cc 4 cyl 95.0 mm Bore Ø		<table border="1"> <tr> <td></td> <td>Liner/ Sleeve</td> <td></td> <td></td> <td></td> <td></td> </tr> <tr> <td>Length:</td> <td>189.0</td> <td></td> <td></td> <td></td> <td></td> </tr> <tr> <td>Outside Ø:</td> <td>98.5</td> <td></td> <td></td> <td></td> <td></td> </tr> <tr> <td>Flange Ø:</td> <td>103.5</td> <td></td> <td></td> <td></td> <td></td> </tr> <tr> <td>Flange depth:</td> <td>3.8 +0.8</td> <td></td> <td></td> <td></td> <td></td> </tr> </table>		Liner/ Sleeve					Length:	189.0					Outside Ø:	98.5					Flange Ø:	103.5					Flange depth:	3.8 +0.8					<table border="1"> <tr> <td></td> <td>Piston</td> </tr> <tr> <td>Length:</td> <td>115.3</td> </tr> <tr> <td>Comp. height:</td> <td>58.3 +0</td> </tr> </table>		Piston	Length:	115.3	Comp. height:	58.3 +0	Kolben Set/ Pistón Set/ поршневой	<table border="1"> <tr> <td></td> <td colspan="2">Rings</td> <td></td> <td></td> </tr> <tr> <td>Top:</td> <td>2.38</td> <td>Ø:</td> <td>31.75</td> <td></td> </tr> <tr> <td>2nd:</td> <td>2.38</td> <td>Length:</td> <td>75.0</td> <td></td> </tr> <tr> <td>oil:</td> <td>4.76</td> <td></td> <td></td> <td></td> </tr> </table>		Rings				Top:	2.38	Ø:	31.75		2nd:	2.38	Length:	75.0		oil:	4.76				
			Liner/ Sleeve																																																											
		Length:	189.0																																																											
		Outside Ø:	98.5																																																											
		Flange Ø:	103.5																																																											
Flange depth:	3.8 +0.8																																																													
	Piston																																																													
Length:	115.3																																																													
Comp. height:	58.3 +0																																																													
	Rings																																																													
Top:	2.38	Ø:	31.75																																																											
2nd:	2.38	Length:	75.0																																																											
oil:	4.76																																																													
Reference no.:		Reference no.:	Reference no.:	Reference no.:																																																										
1363-23-051 1363-23-051A SE01-23-051		1363-23-200	1363-23-206 SE01-23-130 SE01-23-206	0636-11-213																																																										
NM-Motorservice Article no./ Artikelnummer/ Modelo número/ статья номер	NM-Motorservice Article no.:	NM-Motorservice Article no.:	NM-Motorservice Article no.:	NM-Motorservice Article no.:	NM-Motorservice Article no.:																																																									
	LBS 22900F LBS 22900 S	LB 22900 F LB 22900 S	KBS 22900	KB 22900	KR 22900	PB 22900																																																								

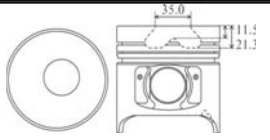

ENGINE TYPE Motortyp/ tipo de motor/ тип двигателя	LINER KIT Liner Kit/ camisas de los cilindros/ Лайнер комплект	CYL. LINER Zylinderlaufbuchse/ camisas de los cilindros/ втулка цилиндра	PISTON + RINGS Kolben + Ringe/ Pistón + Anillos/ поршень и кольца	PISTON SET Kolben Set/ Pistón Set/ поршневой	RINGS SET Ring Set/ Anillos Set/ кольца	PIN Pin/ Perno/ Пин	
HA T3000 4 cc 2,977 cyl 95.0 mm Bore Ø		Liner/ Sleeve	Piston		Rings		
		Length: Outside Ø: Flange Ø: Flange depth:	189.0 98.5 103.5 3.8 0.8	Length: Comp. height:	100.7 53.7 -2.0	Top: 2nd: oil:	2.38 2.38 4.76
		Reference no.:		Reference no.:	Reference no.:	Reference no.:	
		1363-23-051 1363-23-051A SE01-23-051		SE01-23-200A	1363-23-206 SE01-23-130 SE01-23-206	SE01-11-213	
NM-Motorservice Article no./ Artikelnummer/ Modelo número/ статья номер	NM-Motorservice Article no.:	NM-Motorservice Article no.:	NM-Motorservice Article no.:	NM-Motorservice Article no.:	NM-Motorservice Article no.:	NM-Motorservice Article no.:	
	LBS 22950 F LBS 22950 S	LB 22950 F LB 22950 S	KBS 22950	KB 22950	KR 22950	PB 22950	

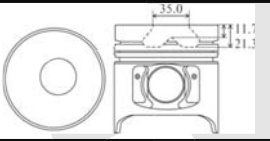

ENGINE TYPE Motortyp/ tipo de motor/ тип двигателя	LINER KIT Liner Kit/ camisas de los cilindros/ Лайнер комплект	CYL. LINER Zylinderlaufbuchse/ camisas de los cilindros/ втулка цилиндра	PISTON + RINGS Kolben + Ringe/ Pistón + Anillos/ поршень и кольца	PISTON SET Kolben Set/ Pistón Set/ поршневой	RINGS SET Ring Set/ Anillos Set/ кольца	PIN Pin/ Perno/ Пин		
W9 2,892 cc W9 cyl 95.0 mm Bore Ø		Liner/ Sleeve	Piston		Rings			
		Length: Outside Ø: Flange Ø: Flange depth:	189.0 98.5 103.5 3.8 +0.8	Length: Comp. height:	87.3 47.8 -3.1	Alfin and with oil gallery	Top: 2nd: oil:	2.5 2.0 3.0
		Reference no.:		Reference no.:	Reference no.:	Reference no.:		
		1363-23-051 1363-23-051A SE01-23-051		W9Y1-11-SAO W9Y1-11-SAOB	W9Y1-11-SCO			
NM-Motorservice Article no./ Artikelnummer/ Modelo número/ статья номер	NM-Motorservice Article no.:	NM-Motorservice Article no.:	NM-Motorservice Article no.:	NM-Motorservice Article no.:	NM-Motorservice Article no.:	NM-Motorservice Article no.:		
	LBS 23000 FB LBS 23000 SB	LB 23000 F LB 23000 S	KBS 23000 B	KB 23000 B	KR 23000	PB 23000		

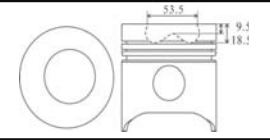

ENGINE TYPE Motortyp/ tipo de motor/ тип двигателя	LINER KIT Liner Kit/ camisas de los cilindros/ Лайнер комплект	CYL. LINER Zylinderlaufbuchse/ camisas de los cilindros/ втулка цилиндра	PISTON + RINGS Kolben + Ringe/ Pistón + Anillos/ поршень и кольца	PISTON SET Kolben Set/ Pistón Set/ поршневой	RINGS SET Ring Set/ Anillos Set/ кольца	PIN Pin/ Perno/ Пин		
WE BT-50 (2006-2008) 2,953 cc 4 cyl 96.0 mm Bore Ø		Liner/ Sleeve	Piston		Rings			
		Length: Outside Ø: Flange Ø: Flange depth:	172.5 99.5 105.5 3.8	Length: Comp. height:	86.2 51.7 -7.5 -16.2	Alfin and with oil gallery skirt MOS2 treated	Top: 2nd: oil:	2.0 1.5 2.0
		Reference no.:		Reference no.:	Reference no.:	Reference no.:		
				WEY1-11-SAO	WEY1-11-SCO	WE01-11-213 WE01-11-213A		
NM-Motorservice Article no./ Artikelnummer/ Modelo número/ статья номер	NM-Motorservice Article no.:	NM-Motorservice Article no.:	NM-Motorservice Article no.:	NM-Motorservice Article no.:	NM-Motorservice Article no.:	NM-Motorservice Article no.:		
	LBS 23050 F LBS 23050 S	LB 23050 F LB 23050 S	KBS 23050	KB 23050	KR 23050	PB 23050		

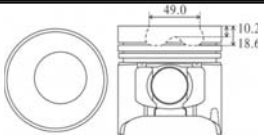

ENGINE TYPE Motortyp/ tipo de motor/ тип двигателя	LINER KIT Liner Kit/ camisas de los cilindros/ Лайнер комплект	CYL. LINER Zylinderlaufbuchse/ camisas de los cilindros/ втулка цилиндра	PISTON + RINGS Kolben + Ringe/ Pistón + Anillos/ поршень и кольца	PISTON SET Kolben Set/ Pistón Set/ поршневой	RINGS SET Ring Set/ Anillos Set/ кольца	PIN Pin/ Perno/ Пин																															
SL T3500 3,455 cc 4 cyl 100.0 mm Bore Ø	Liner OD is graded as A and B	<table border="1"> <tr> <td></td> <td>Liner/ Sleeve</td> <td></td> </tr> <tr> <td>Length:</td> <td>193.5</td> <td></td> </tr> <tr> <td>Outside Ø:</td> <td>103.5</td> <td></td> </tr> <tr> <td>Flange Ø:</td> <td>108.0</td> <td></td> </tr> <tr> <td>Flange depth:</td> <td>2.5</td> <td>81.8</td> </tr> </table>		Liner/ Sleeve		Length:	193.5		Outside Ø:	103.5		Flange Ø:	108.0		Flange depth:	2.5	81.8	<table border="1"> <tr> <td colspan="2">Piston</td> </tr> <tr> <td>Length:</td> <td>2.5</td> </tr> <tr> <td>Comp. height:</td> <td>2.0 4.5</td> </tr> </table>	Piston		Length:	2.5	Comp. height:	2.0 4.5	With oil gallery head anodized (= G)	<table border="1"> <tr> <td colspan="2">Rings</td> </tr> <tr> <td>Top:</td> <td>2.5</td> </tr> <tr> <td>2nd: oil:</td> <td>2.0 4.0</td> </tr> </table>	Rings		Top:	2.5	2nd: oil:	2.0 4.0	<table border="1"> <tr> <td>Ø:</td> <td>34.0</td> </tr> <tr> <td>Length:</td> <td>81.8</td> </tr> </table>	Ø:	34.0	Length:	81.8
				Liner/ Sleeve																																	
Length:	193.5																																				
Outside Ø:	103.5																																				
Flange Ø:	108.0																																				
Flange depth:	2.5	81.8																																			
Piston																																					
Length:	2.5																																				
Comp. height:	2.0 4.5																																				
Rings																																					
Top:	2.5																																				
2nd: oil:	2.0 4.0																																				
Ø:	34.0																																				
Length:	81.8																																				
		Reference no.:		Reference no.:	Reference no.:	Reference no.:																															
		SL01-23-311 SL01-23-312 SL07-23-051		SL07-23-200 SL07-23-200B	SL07-23-206 SL07-23-206A	SL01-11-213																															
NM-Motorservice Article no./ Artikelnummer/ Modelo número/ статья номер	NM-Motorservice Article no.:	NM-Motorservice Article no.:	NM-Motorservice Article no.:	NM-Motorservice Article no.:	NM-Motorservice Article no.:	NM-Motorservice Article no.:																															
	LBS 23100 FG LBS 23100 SG	LB 23100 F (phosphated) LB 23100 S	KBS 23100 G	KB 23100 G	KR 23100	PB 23100																															



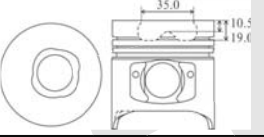

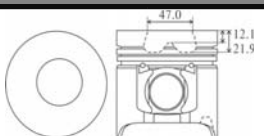

ENGINE TYPE Motortyp/ tipo de motor/ тип двигателя	LINER KIT Liner Kit/ camisas de los cilindros/ Лайнер комплект	CYL. LINER Zylinderlaufbuchse/ camisas de los cilindros/ втулка цилиндра	PISTON + RINGS Kolben + Ringe/ Pistón + Anillos/ поршень и кольца	PISTON SET Kolben Set/ Pistón Set/ поршневой	RINGS SET Ring Set/ Anillos Set/ кольца	PIN Pin/ Perno/ Пин																															
SL T3500 3,455 cc 4 cyl 100.0 mm Bore Ø	Liner OD is graded as A and B	<table border="1"> <tr> <td></td> <td>Liner/ Sleeve</td> <td></td> </tr> <tr> <td>Length:</td> <td>193.5</td> <td></td> </tr> <tr> <td>Outside Ø:</td> <td>103.5</td> <td></td> </tr> <tr> <td>Flange Ø:</td> <td>108.0</td> <td></td> </tr> <tr> <td>Flange depth:</td> <td>2.5</td> <td>+0.8</td> </tr> </table>		Liner/ Sleeve		Length:	193.5		Outside Ø:	103.5		Flange Ø:	108.0		Flange depth:	2.5	+0.8	<table border="1"> <tr> <td colspan="2">Piston</td> </tr> <tr> <td>Length:</td> <td>105.0</td> </tr> <tr> <td>Comp. height:</td> <td>58.0 -11.7 -21.3</td> </tr> </table>	Piston		Length:	105.0	Comp. height:	58.0 -11.7 -21.3	Alfin head anodized	<table border="1"> <tr> <td colspan="2">Rings</td> </tr> <tr> <td>Top:</td> <td>2.5</td> </tr> <tr> <td>2nd: oil:</td> <td>2.0 4.5</td> </tr> </table>	Rings		Top:	2.5	2nd: oil:	2.0 4.5	<table border="1"> <tr> <td>Ø:</td> <td>34.0</td> </tr> <tr> <td>Length:</td> <td>82.0</td> </tr> </table>	Ø:	34.0	Length:	82.0
				Liner/ Sleeve																																	
Length:	193.5																																				
Outside Ø:	103.5																																				
Flange Ø:	108.0																																				
Flange depth:	2.5	+0.8																																			
Piston																																					
Length:	105.0																																				
Comp. height:	58.0 -11.7 -21.3																																				
Rings																																					
Top:	2.5																																				
2nd: oil:	2.0 4.5																																				
Ø:	34.0																																				
Length:	82.0																																				
		Reference no.:		Reference no.:	Reference no.:	Reference no.:																															
		SL01-23-311 SL01-23-312 SL07-23-051		SL01-23-200A	SL01-23-206 SL01-23-206A	SL01-11-213																															
NM-Motorservice Article no./ Artikelnummer/ Modelo número/ статья номер	NM-Motorservice Article no.:	NM-Motorservice Article no.:	NM-Motorservice Article no.:	NM-Motorservice Article no.:	NM-Motorservice Article no.:	NM-Motorservice Article no.:																															
	LBS 23150 FA LBS 23150 SA	LB 23150 F (phosphated) LB 23150 S	KBS 23150 A	KB 23150 A	KR 23150	PB 23150																															

ENGINE TYPE Motortyp/ tipo de motor/ тип двигателя	LINER KIT Liner Kit/ camisas de los cilindros/ Лайнер комплект	CYL. LINER Zylinderlaufbuchse/ camisas de los cilindros/ втулка цилиндра	PISTON + RINGS Kolben + Ringe/ Pistón + Anillos/ поршень и кольца	PISTON SET Kolben Set/ Pistón Set/ поршневой	RINGS SET Ring Set/ Anillos Set/ кольца	PIN Pin/ Perno/ Пин																															
SLT T3500T 3,455 cc 4 cyl 100.0 mm Bore Ø	Liner OD is graded as A and B	<table border="1"> <tr> <td></td> <td>Liner/ Sleeve</td> <td></td> </tr> <tr> <td>Length:</td> <td>193.5</td> <td></td> </tr> <tr> <td>Outside Ø:</td> <td>103.5</td> <td></td> </tr> <tr> <td>Flange Ø:</td> <td>108.0</td> <td></td> </tr> <tr> <td>Flange depth:</td> <td>2.5</td> <td>+0.8</td> </tr> </table>		Liner/ Sleeve		Length:	193.5		Outside Ø:	103.5		Flange Ø:	108.0		Flange depth:	2.5	+0.8	<table border="1"> <tr> <td colspan="2">Piston</td> </tr> <tr> <td>Length:</td> <td>105.2</td> </tr> <tr> <td>Comp. height:</td> <td>58.2 -9.5 -18.5</td> </tr> </table>	Piston		Length:	105.2	Comp. height:	58.2 -9.5 -18.5	Alfin and with oil gallery	<table border="1"> <tr> <td colspan="2">Rings</td> </tr> <tr> <td>Top:</td> <td>2.5</td> </tr> <tr> <td>2nd: oil:</td> <td>2.0 4.5</td> </tr> </table>	Rings		Top:	2.5	2nd: oil:	2.0 4.5	<table border="1"> <tr> <td>Ø:</td> <td>34.0</td> </tr> <tr> <td>Length:</td> <td>81.8</td> </tr> </table>	Ø:	34.0	Length:	81.8
				Liner/ Sleeve																																	
Length:	193.5																																				
Outside Ø:	103.5																																				
Flange Ø:	108.0																																				
Flange depth:	2.5	+0.8																																			
Piston																																					
Length:	105.2																																				
Comp. height:	58.2 -9.5 -18.5																																				
Rings																																					
Top:	2.5																																				
2nd: oil:	2.0 4.5																																				
Ø:	34.0																																				
Length:	81.8																																				
		Reference no.:		Reference no.:	Reference no.:	Reference no.:																															
		SL01-23-311 SL01-23-312 SL07-23-051		SL50-11-SAO	SL50-11-SCO	SL01-11-213																															
NM-Motorservice Article no./ Artikelnummer/ Modelo número/ статья номер	NM-Motorservice Article no.:	NM-Motorservice Article no.:	NM-Motorservice Article no.:	NM-Motorservice Article no.:	NM-Motorservice Article no.:	NM-Motorservice Article no.:																															
	LBS 23200 FB LBS 23200 SB	LB 23200 F (phosphated) LB 23200 S	KBS 23200	KB 23200	KR 23200	PB 23200																															

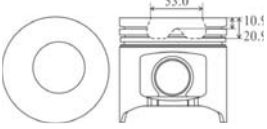
ENGINE TYPE Motortyp/ tipo de motor/ тип двигателя	LINER KIT Liner Kit/ camisas de los cilindros/ Лайнер комплект	CYL. LINER Zylinderlaufbuchse/ camisas de los cilindros/ втулка цилиндра	PISTON + RINGS Kolben + Ringe/ Pistón + Anillos/ поршень и кольца		PISTON SET Kolben Set/ Pistón Set/ поршневой	RINGS SET Ring Set/ Anillos Set/ кольца	PIN Pin/ Perno/ Пин	
SLT T3500T 3,455 cc 4 cyl 100.0 mm Bore Ø	Liner OD is graded as W X and Y Z	Liner/ Sleeve	Piston		Alfin and with oil gallery head anodized	Rings		Ø : 34.0 Length: 82.0
			Length: Outside Ø: Flange Ø: Flange depth:	193.5 103.5 108.0 2.5 +0.8		Length: Comp. height:	105.0 58.0 -10.2 -18.6	
	Reference no.:	Reference no.:		Reference no.:	Reference no.:	Reference no.:		
		SL01-23-311 SL01-23-312 SL07-23-051			SLA1-11-SAO SLN5-11-SAO	SL50-11-SCO	SL01-11-213	
NM-Motorservice Article no./ Artikelnummer/ Modelo número/ статья номер	NM-Motorservice Article no.:	NM-Motorservice Article no.:	NM-Motorservice Article no.:	NM-Motorservice Article no.:	NM-Motorservice Article no.:	NM-Motorservice Article no.:	NM-Motorservice Article no.:	
	LBS 23250 FB LBS 23250 SB	LB 23250 F (phosphated) LB 23250 S	KBS 23250 B	KB 23250 B	KR 23250	PB 23250		

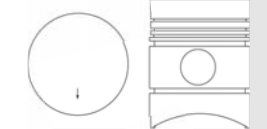
ENGINE TYPE Motortyp/ tipo de motor/ тип двигателя	LINER KIT Liner Kit/ camisas de los cilindros/ Лайнер комплект	CYL. LINER Zylinderlaufbuchse/ camisas de los cilindros/ втулка цилиндра	PISTON + RINGS Kolben + Ringe/ Pistón + Anillos/ поршень и кольца		PISTON SET Kolben Set/ Pistón Set/ поршневой	RINGS SET Ring Set/ Anillos Set/ кольца	PIN Pin/ Perno/ Пин	
SL T3500 3,455 cc 4 cyl 100.0 mm Bore Ø	Liner OD is graded as A and B	Liner/ Sleeve	Piston			Rings		Ø : 34.0 Length: 82.0
			Length: Outside Ø: Flange Ø: Flange depth:	193.5 103.5 108.0 2.5 +0.8		Length: Comp. height:	105.0 58.0 -10.5 -19.0	
	Reference no.:	Reference no.:		Reference no.:	Reference no.:	Reference no.:		
		SL01-23-311 SL01-23-312 SL07-23-051			SL70-11-SAO	SL01-23-206 SL01-23-206A	SL01-11-213	
NM-Motorservice Article no./ Artikelnummer/ Modelo número/ статья номер	NM-Motorservice Article no.:	NM-Motorservice Article no.:	NM-Motorservice Article no.:	NM-Motorservice Article no.:	NM-Motorservice Article no.:	NM-Motorservice Article no.:	NM-Motorservice Article no.:	
	LBS 23300 FA LBS 23300 SA	LB 23300 F (phosphated) LB 23300 S	KBS 23300 A	KB 23300 A	KR 23300	PB 23300		

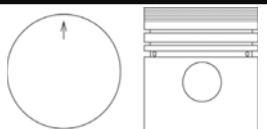

ENGINE TYPE Motortyp/ tipo de motor/ тип двигателя	LINER KIT Liner Kit/ camisas de los cilindros/ Лайнер комплект	CYL. LINER Zylinderlaufbuchse/ camisas de los cilindros/ втулка цилиндра	PISTON + RINGS Kolben + Ringe/ Pistón + Anillos/ поршень и кольца		PISTON SET Kolben Set/ Pistón Set/ поршневой	RINGS SET Ring Set/ Anillos Set/ кольца	PIN Pin/ Perno/ Пин	
TF T4000 4,021 cc 4 cyl 105.5 mm Bore Ø	Liner OD is graded as A and B	Liner/ Sleeve	Piston		Alfin and with oil gallery	Rings		Ø : 35.0 Length: 87.0
			Length: Outside Ø: Flange Ø: Flange depth:	200.0 109.0 114.5 6.0 +1.0		Length: Comp. height:	108.3 61.4 -12.1 -21.9	
	Reference no.:	Reference no.:		Reference no.:	Reference no.:	Reference no.:		
		TFY0-10-311 TFY0-10-311A TFY0-10-311B TFY0-10-313			TF01-11-SAO TF20-11-SAO	TF01-11-SCO	TF01-11-213	
NM-Motorservice Article no./ Artikelnummer/ Modelo número/ статья номер	NM-Motorservice Article no.:	NM-Motorservice Article no.:	NM-Motorservice Article no.:	NM-Motorservice Article no.:	NM-Motorservice Article no.:	NM-Motorservice Article no.:	NM-Motorservice Article no.:	
	LBS 23350 FB LBS 23350 SB	LB 23350 F (phosphated) LB 23350 S	KBS 23350 B	KB 23350 B	KR 23350	PB 23350		



ENGINE TYPE Motortyp/ tipo de motor/ тип двигателя	LINER KIT Liner Kit/ camisas de los cilindros/ Лайнер комплект	CYL. LINER Zylinderlaufbuchse/ camisas de los cilindros/ втулка цилиндра	PISTON + RINGS Kolben + Ringe/ Pistón + Anillos/ поршень и кольца	PISTON SET Kolben Set/ Pistón Set/ поршневой	RINGS SET Ring Set/ Anillos Set/ кольца	PIN Pin/ Perno/ Пин																																																
TM 4,553 cc 4 cyl 109.0 mm Bore Ø	Liner OD is graded as A and B	<table border="1"> <thead> <tr> <th></th> <th>Liner/ Sleeve</th> <th></th> <th>Piston</th> </tr> </thead> <tbody> <tr> <td>Length:</td> <td>202.0</td> <td></td> <td>Length: 107.3</td> </tr> <tr> <td>Outside Ø:</td> <td>112.5</td> <td></td> <td>Comp. 61.3</td> </tr> <tr> <td>Flange Ø:</td> <td>118.0</td> <td></td> <td>height: -10.9</td> </tr> <tr> <td>Flange depth:</td> <td>6.0</td> <td></td> <td>-20.9</td> </tr> <tr> <td></td> <td>+1.0</td> <td></td> <td></td> </tr> </tbody> </table>		Liner/ Sleeve		Piston	Length:	202.0		Length: 107.3	Outside Ø:	112.5		Comp. 61.3	Flange Ø:	118.0		height: -10.9	Flange depth:	6.0		-20.9		+1.0			Alfin and with oil gallery	<table border="1"> <thead> <tr> <th colspan="2">Rings</th> <th></th> <th></th> </tr> </thead> <tbody> <tr> <td>Top:</td> <td>3.0</td> <td>Ø:</td> <td>35.0</td> </tr> <tr> <td>2nd:</td> <td>2.0</td> <td>Length:</td> <td>79.0</td> </tr> <tr> <td>oil:</td> <td>3.0</td> <td></td> <td></td> </tr> </tbody> </table>	Rings				Top:	3.0	Ø:	35.0	2nd:	2.0	Length:	79.0	oil:	3.0												
			Liner/ Sleeve		Piston																																																	
Length:	202.0		Length: 107.3																																																			
Outside Ø:	112.5		Comp. 61.3																																																			
Flange Ø:	118.0		height: -10.9																																																			
Flange depth:	6.0		-20.9																																																			
	+1.0																																																					
Rings																																																						
Top:	3.0	Ø:	35.0																																																			
2nd:	2.0	Length:	79.0																																																			
oil:	3.0																																																					
		Reference no.: TMY0-10-311 TMY0-10-313		Reference no.: TMY0-11-200 TMY0-11-SAO	Reference no.: TMY0-11-SCO	Reference no.: TF01-11-213																																																
NM-Motorservice Article no./ Artikelnummer/ Modelo número/ статья номер	NM-Motorservice Article no.:	NM-Motorservice Article no.:	NM-Motorservice Article no.:	NM-Motorservice Article no.:	NM-Motorservice Article no.:	NM-Motorservice Article no.:																																																
	LBS 23400 FB LBS 23400 SB	LB 23400 F (phosphated) LB 23350 S	KBS 23400 B	KB 23400 B	KR 23400	PB 23400																																																
ZB E4100 5 Rings 4,052 cc 6 cyl 92.0 mm Bore Ø	Liner Kit/ camisas de los cilindros/ Лайнер комплект	<table border="1"> <thead> <tr> <th></th> <th>Liner/ Sleeve</th> <th></th> <th>Piston</th> </tr> </thead> <tbody> <tr> <td>Length:</td> <td>191.0</td> <td></td> <td>Length: 115.7</td> </tr> <tr> <td>Outside Ø:</td> <td>96.9</td> <td></td> <td>Comp. 60.2</td> </tr> <tr> <td>Flange Ø:</td> <td>101.0</td> <td></td> <td>height: +0</td> </tr> <tr> <td>Flange depth:</td> <td>3.8</td> <td></td> <td></td> </tr> <tr> <td></td> <td>+0.8</td> <td></td> <td></td> </tr> </tbody> </table>		Liner/ Sleeve		Piston	Length:	191.0		Length: 115.7	Outside Ø:	96.9		Comp. 60.2	Flange Ø:	101.0		height: +0	Flange depth:	3.8				+0.8			<table border="1"> <thead> <tr> <th colspan="2">Rings</th> <th></th> <th></th> </tr> </thead> <tbody> <tr> <td>Top:</td> <td>2.38</td> <td>Ø:</td> <td>31.75</td> </tr> <tr> <td>2nd:</td> <td>2.38</td> <td>Length:</td> <td>75.0</td> </tr> <tr> <td>3rd:</td> <td>2.38</td> <td></td> <td></td> </tr> <tr> <td>1st oil:</td> <td>4.76</td> <td></td> <td></td> </tr> <tr> <td>2nd oil:</td> <td>4.76</td> <td></td> <td></td> </tr> </tbody> </table>	Rings				Top:	2.38	Ø:	31.75	2nd:	2.38	Length:	75.0	3rd:	2.38			1st oil:	4.76			2nd oil:	4.76					
			Liner/ Sleeve		Piston																																																	
Length:	191.0		Length: 115.7																																																			
Outside Ø:	96.9		Comp. 60.2																																																			
Flange Ø:	101.0		height: +0																																																			
Flange depth:	3.8																																																					
	+0.8																																																					
Rings																																																						
Top:	2.38	Ø:	31.75																																																			
2nd:	2.38	Length:	75.0																																																			
3rd:	2.38																																																					
1st oil:	4.76																																																					
2nd oil:	4.76																																																					
		Reference no.: 0528-10-311 V101-23-051		Reference no.: 0528-23-200	Reference no.: 0784-23-206 0785-23-206	Reference no.: 0636-11-213																																																
NM-Motorservice Article no./ Artikelnummer/ Modelo número/ статья номер	NM-Motorservice Article no.:	NM-Motorservice Article no.:	NM-Motorservice Article no.:	NM-Motorservice Article no.:	NM-Motorservice Article no.:	NM-Motorservice Article no.:																																																
	LBS 23450 F LBS 23450 S	LB 23450 F LB 23450S	KBS 23450	KB 23450	KR 23450	PB 23450																																																
ZB T4100 3 Rings 4,052 cc 6 cyl 92.0 mm Bore Ø	Liner Kit/ camisas de los cilindros/ Лайнер комплект	<table border="1"> <thead> <tr> <th></th> <th>Liner/ Sleeve</th> <th></th> <th>Piston</th> </tr> </thead> <tbody> <tr> <td>Length:</td> <td>191.0</td> <td></td> <td>Length: 103.4</td> </tr> <tr> <td>Outside Ø:</td> <td>96.9</td> <td></td> <td>Comp. 60.4</td> </tr> <tr> <td>Flange Ø:</td> <td>101.0</td> <td></td> <td>height: +0</td> </tr> <tr> <td>Flange depth:</td> <td>3.8</td> <td></td> <td></td> </tr> <tr> <td></td> <td>+0.8</td> <td></td> <td></td> </tr> </tbody> </table>		Liner/ Sleeve		Piston	Length:	191.0		Length: 103.4	Outside Ø:	96.9		Comp. 60.4	Flange Ø:	101.0		height: +0	Flange depth:	3.8				+0.8			<table border="1"> <thead> <tr> <th colspan="2">Rings</th> <th></th> <th></th> </tr> </thead> <tbody> <tr> <td>Top:</td> <td>2.38</td> <td>Ø:</td> <td>31.75</td> </tr> <tr> <td>2nd:</td> <td>2.38</td> <td>Length:</td> <td>75.0</td> </tr> <tr> <td>oil:</td> <td>4.76</td> <td></td> <td></td> </tr> </tbody> </table>	Rings				Top:	2.38	Ø:	31.75	2nd:	2.38	Length:	75.0	oil:	4.76													
			Liner/ Sleeve		Piston																																																	
Length:	191.0		Length: 103.4																																																			
Outside Ø:	96.9		Comp. 60.4																																																			
Flange Ø:	101.0		height: +0																																																			
Flange depth:	3.8																																																					
	+0.8																																																					
Rings																																																						
Top:	2.38	Ø:	31.75																																																			
2nd:	2.38	Length:	75.0																																																			
oil:	4.76																																																					
		Reference no.: 0528-10-311 V101-23-051		Reference no.: V101-23-200	Reference no.: V101-23-206	Reference no.: 0636-11-213																																																
NM-Motorservice Article no./ Artikelnummer/ Modelo número/ статья номер	NM-Motorservice Article no.:	NM-Motorservice Article no.:	NM-Motorservice Article no.:	NM-Motorservice Article no.:	NM-Motorservice Article no.:	NM-Motorservice Article no.:																																																
	LBS 44000 F LBS 44000 S	LB 44000 F LB 44000 S	KBS 44000	KB 44000	KR 44000	PB 44000																																																

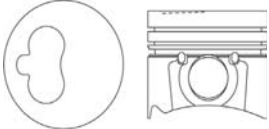

ENGINE TYPE Motortyp/ tipo de motor/ тип двигателя	LINER KIT Liner Kit/ camisas de los cilindros/ Лайнер комплект	CYL. LINER Zylinderlaufbuchse/ camisas de los cilindros/ втулка цилиндра		PISTON + RINGS Kolben + Ringe/ Pistón + Anillos/ поршень и кольца	PISTON SET Kolben Set/ Pistón Set/ поршневой	RINGS SET Ring Set/ Anillos Set/ кольца	PIN Pin/ Perno/ Пин
K3E/ K4E 1,061 cc / 1,415 cc 3 / 4 cyl 76.0 mm Bore Ø			Flange	No flange	Piston	Rings	Ø : 23.0 Length: 62.0
		Length: Outside Ø: Flange Ø: Flange depth:					
		Reference no.:		Reference no.:		Reference no.:	Reference no.:
				30A17-00050 30A17-00060 30A17-00070 30A17-00080		MM431579 MM431631 MM431632 MM431633	MM430145
NM-Motorservice Article no./ Artikelnummer/ Modelo número/ статья номер	NM-Motorservice Article no.:	NM-Motorservice Article no.:		NM-Motorservice Article no.:	NM-Motorservice Article no.:	NM-Motorservice Article no.:	NM-Motorservice Article no.:
	LBS 23550 P LBS 23550 S	LB 23550 P LB 23550 S		KBS 23550	KB 23550	KR 23550	PB 23550

ENGINE TYPE Motortyp/ tipo de motor/ тип двигателя	LINER KIT Liner Kit/ camisas de los cilindros/ Лайнер комплект	CYL. LINER Zylinderlaufbuchse/ camisas de los cilindros/ втулка цилиндра		PISTON + RINGS Kolben + Ringe/ Pistón + Anillos/ поршень и кольца	PISTON SET Kolben Set/ Pistón Set/ поршневой	RINGS SET Ring Set/ Anillos Set/ кольца	PIN Pin/ Perno/ Пин
NM75 406 cc 1 cyl 78.0 mm Bore Ø			Flange	No flange	Piston	Rings	Ø : 23.0 Length: 65.0
		Length: Outside Ø: Flange Ø: Flange depth:					
		Reference no.:		Reference no.:		Reference no.:	Reference no.:
				MM400470			
NM-Motorservice Article no./ Artikelnummer/ Modelo número/ статья номер	NM-Motorservice Article no.:	NM-Motorservice Article no.:		NM-Motorservice Article no.:	NM-Motorservice Article no.:	NM-Motorservice Article no.:	NM-Motorservice Article no.:
	LBS 23600 P LBS 23600S	LB 23600 P LB 23600 S		KBS 23600	KB 23600	KR 23600	PB 23600

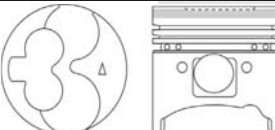
ENGINE TYPE Motortyp/ tipo de motor/ тип двигателя	LINER KIT Liner Kit/ camisas de los cilindros/ Лайнер комплект	CYL. LINER Zylinderlaufbuchse/ camisas de los cilindros/ втулка цилиндра		PISTON + RINGS Kolben + Ringe/ Pistón + Anillos/ поршень и кольца	PISTON SET Kolben Set/ Pistón Set/ поршневой	RINGS SET Ring Set/ Anillos Set/ кольца	PIN Pin/ Perno/ Пин
NM90 477 cc 1 cyl 80.0 mm Bore Ø			Flange	No flange	Piston	Rings	Ø : 25.0 Length: 67.0
		Length: Outside Ø: Flange Ø: Flange depth:					
		Reference no.:		Reference no.:		Reference no.:	Reference no.:
				MM404575			
NM-Motorservice Article no./ Artikelnummer/ Modelo número/ статья номер	NM-Motorservice Article no.:	NM-Motorservice Article no.:		NM-Motorservice Article no.:	NM-Motorservice Article no.:	NM-Motorservice Article no.:	NM-Motorservice Article no.:
	LBS 23650 P LBS 23650 S	LB 23650 P LB 23650 S		KBS 23650	KB 23650	KR 23650	PB 23650

ENGINE TYPE Motortyp/ tipo de motor/ тип двигателя	LINER KIT Liner Kit/ camisas de los cilindros/ Лайнер комплект	CYL. LINER Zylinderlaufbuchse/ camisas de los cilindros/ втулка цилиндра		PISTON + RINGS Kolben + Ringe/ Pistón + Anillos/ поршень и кольца	PISTON SET Kolben Set/ Pistón Set/ поршневой	RINGS SET Ring Set/ Anillos Set/ кольца	PIN Pin/ Perno/ Пин		
F8Q 784 TURBO CARISMA 1.9 TD also for RENAULT VOLVO 1,870 cc 4 cyl 80.0 mm Bore Ø			Flange	No flange	Piston	Alfin and with oil gallery	Rings	Ø : Length:	26.0 66.5
		Length: Outside Ø: Flange Ø: Flange depth:	154.0 83.05 86.0 5.0						
		Reference no.:		Reference no.:	Reference no.:	Reference no.:	Reference no.:	Reference no.:	
				A-A350542 N-8710350000	M345509 M883402	A-R60260 G-0810150000 K-800036140000 M-02158V0 M345510 M883403			
NM-Motorservice Article no./ Artikelnummer/ Modelo número/ статья номер	NM-Motorservice Article no.:	NM-Motorservice Article no.:		NM-Motorservice Article no.:	NM-Motorservice Article no.:	NM-Motorservice Article no.:	NM-Motorservice Article no.:		NM-Motorservice Article no.:
	LBS 23700 P LBS 23700 S	LB 23700 P LB 23700 S		KBS 23700	KB 23700	KR 23700	PB 23700		

ENGINE TYPE Motortyp/ tipo de motor/ тип двигателя	LINER KIT Liner Kit/ camisas de los cilindros/ Лайнер комплект	CYL. LINER Zylinderlaufbuchse/ camisas de los cilindros/ втулка цилиндра		PISTON + RINGS Kolben + Ringe/ Pistón + Anillos/ поршень и кольца	PISTON SET Kolben Set/ Pistón Set/ поршневой	RINGS SET Ring Set/ Anillos Set/ кольца	PIN Pin/ Perno/ Пин		
4D65 1,795 cc 4 cyl 80.6 mm Bore Ø			Flange	No flange	Piston	Rings	Ø : Length:	25.0 68.0	
		Length: Outside Ø: Flange Ø: Flange depth:	150.0 84.6 90.5 4.0	146.0 84.6					Length: Comp. height:
		Reference no.:			Reference no.:	Reference no.:	Reference no.:		
					MD061985	MD071206 MD078209 MD078309 MD127017 MD127022 MD136692	MD060467		
NM-Motorservice Article no./ Artikelnummer/ Modelo número/ статья номер	NM-Motorservice Article no.:	NM-Motorservice Article no.:		NM-Motorservice Article no.:	NM-Motorservice Article no.:	NM-Motorservice Article no.:	NM-Motorservice Article no.:		NM-Motorservice Article no.:
	LBS 23750 P LBS 23750 S	LB 23750 P LB 23750 S		KBS 23750	KB 23750	KR 23750	PB 23750		

ENGINE TYPE Motortyp/ tipo de motor/ тип двигателя	LINER KIT Liner Kit/ camisas de los cilindros/ Лайнер комплект	CYL. LINER Zylinderlaufbuchse/ camisas de los cilindros/ втулка цилиндра		PISTON + RINGS Kolben + Ringe/ Pistón + Anillos/ поршень и кольца	PISTON SET Kolben Set/ Pistón Set/ поршневой	RINGS SET Ring Set/ Anillos Set/ кольца	PIN Pin/ Perno/ Пин		
4D65T 1,795 cc 4 cyl 80.6 mm Bore Ø			Liner/ Sleeve		Piston	Rings	Ø : Length:	25.0 68.0	
		Length: Outside Ø: Flange Ø: Flange depth:	150.0 84.6 90.5 4.0						Length: Comp. height:
		Reference no.:			Reference no.:	Reference no.:	Reference no.:		
					MD072264	MD071206 MD078209 MD078309 MD127017 MD127022 MD136692	MD060467		
NM-Motorservice Article no./ Artikelnummer/ Modelo número/ статья номер	NM-Motorservice Article no.:	NM-Motorservice Article no.:		NM-Motorservice Article no.:	NM-Motorservice Article no.:	NM-Motorservice Article no.:	NM-Motorservice Article no.:		NM-Motorservice Article no.:
	LBS 23800 PA LBS 23800 SA	LB 23800 P LB 23800 S		KBS 23800 A	KB 23800 A	KR 23800	PB 23800		

ENGINE TYPE Motortyp/ tipo de motor/ тип двигателя	LINER KIT Liner Kit/ camisas de los cilindros/ Лайнер комплект	CYL. LINER Zylinderlaufbuchse/ camisas de los cilindros/ втулка цилиндра		PISTON + RINGS Kolben + Ringe/ Pistón + Anillos/ поршень и кольца		PISTON SET Kolben Set/ Pistón Set/ поршневой	RINGS SET Ring Set/ Anillos Set/ кольца		PIN Pin/ Perno/ Пин
4D65T 1,795 cc 4 cyl 80.6 mm Bore Ø			Flange	No flange	Piston		Rings		
		Length: Outside Ø: Flange Ø: Flange depth:	150.0 84.6 90.5 4.0	146.0 84.6	Length: Comp. height:	78.7 41.7 -3.6	Top: 2nd: oil:	2.0 2.0 4.0	Ø: Length:
		Reference no.:			Reference no.:	Reference no.:	Reference no.:		
					MD131615	MD071206 MD078209 MD078309 MD127017 MD127022 MD136692	MD060467		
NM-Motorservice Article no./ Artikelnummer/ Modelo número/ статья номер	NM-Motorservice Article no.:	NM-Motorservice Article no.:		NM-Motorservice Article no.:		NM-Motorservice Article no.:	NM-Motorservice Article no.:		NM-Motorservice Article no.:
	LBS 23850 PA LBS 23850 SA	LB 23850 P LB 23850 S		KBS 23850 A		KB 23850 A	KR 23850		PB 23850

ENGINE TYPE Motortyp/ tipo de motor/ тип двигателя	LINER KIT Liner Kit/ camisas de los cilindros/ Лайнер комплект	CYL. LINER Zylinderlaufbuchse/ camisas de los cilindros/ втулка цилиндра		PISTON + RINGS Kolben + Ringe/ Pistón + Anillos/ поршень и кольца		PISTON SET Kolben Set/ Pistón Set/ поршневой	RINGS SET Ring Set/ Anillos Set/ кольца		PIN Pin/ Perno/ Пин
4D68 1,998 cc 4 cyl 82.7 mm Bore Ø			Flange	No flange	Piston		Rings		
		Length: Outside Ø: Flange Ø: Flange depth:	170.0 86.7 90.7 5.0	165.0 86.7	Length: Comp. height:	76.3 39.4 -1.7	Top: 2nd: oil:	2.0 2.0 3.0	Ø: Length:
		Reference no.:			Reference no.:	Reference no.:	Reference no.:		
					MD194163	MD197162	MD060467		
NM-Motorservice Article no./ Artikelnummer/ Modelo número/ статья номер	NM-Motorservice Article no.:	NM-Motorservice Article no.:		NM-Motorservice Article no.:		NM-Motorservice Article no.:	NM-Motorservice Article no.:		NM-Motorservice Article no.:
	LBS 23900 PA LBS 23900 SA	LB 23900 P LB 23900 S		KBS 23900 A		KB 23900 A	KR 23900		PB 23900

ENGINE TYPE Motortyp/ tipo de motor/ тип двигателя	LINER KIT Liner Kit/ camisas de los cilindros/ Лайнер комплект	CYL. LINER Zylinderlaufbuchse/ camisas de los cilindros/ втулка цилиндра		PISTON + RINGS Kolben + Ringe/ Pistón + Anillos/ поршень и кольца		PISTON SET Kolben Set/ Pistón Set/ поршневой	RINGS SET Ring Set/ Anillos Set/ кольца		PIN Pin/ Perno/ Пин
4D68T 1,998 cc 4 cyl 82.7 mm Bore Ø			Flange	No flange	Piston		Rings		
		Length: Outside Ø: Flange Ø: Flange depth:	170.0 86.7 90.7 5.0	165.0 86.7	Length: Comp. height:	76.3 39.3 -1.75	Alfin and with oil gallery	Top: 2nd: oil:	2.0 2.0 3.0
		Reference no.:			Reference no.:	Reference no.:	Reference no.:		
					MD194157	MD197187	MD060467		
NM-Motorservice Article no./ Artikelnummer/ Modelo número/ статья номер	NM-Motorservice Article no.:	NM-Motorservice Article no.:		NM-Motorservice Article no.:		NM-Motorservice Article no.:	NM-Motorservice Article no.:		NM-Motorservice Article no.:
	LBS 23950 PB LBS 23950 SB	LB 23950 P LB 23950 S		KBS 23950 B		KB 23950 B	KR 23950		PB 23950

ENGINE TYPE Motortyp/ tipo de motor/ тип двигателя	LINER KIT Liner Kit/ camisas de los cilindros/ Лайнер комплект	CYL. LINER Zylinderlaufbuchse/ camisas de los cilindros/ втулка цилиндра		PISTON + RINGS Kolben + Ringe/ Pistón + Anillos/ поршень и кольца		PISTON SET Kolben Set/ Pistón Set/ поршневой	RINGS SET Ring Set/ Anillos Set/ кольца		PIN Pin/ Perno/ Пин	
COLT 1.5 DI-D (Z38A/Z39A) 2004- 1,493 cc 3 cyl 83.0 mm Bore Ø			Flange	No flange	Piston		Alfin and with oil gallery skirt MOS2 treated		Rings	
		Length: Outside Ø: Flange Ø: Flange depth:			Length: Comp. height:	71.65 45.65 -14.65			Top: 2nd: oil:	2.0 2.0 2.0
		Reference no.:		Reference no.:		Reference no.:	Reference no.:		Reference no.:	
				MN960060			MN960373		MN960307	
NM-Motorservice Article no./ Artikelnummer/ Modelo número/ статья номер		NM-Motorservice Article no.:		NM-Motorservice Article no.:		NM-Motorservice Article no.:	NM-Motorservice Article no.:		NM-Motorservice Article no.:	
		LBS 39700 PB LBS 39700 SB		LB 39700 P LB 39700 S		KBS 39700 B	KB 39700 B		KR 39700 PB 39700	

ENGINE TYPE Motortyp/ tipo de motor/ тип двигателя	LINER KIT Liner Kit/ camisas de los cilindros/ Лайнер комплект	CYL. LINER Zylinderlaufbuchse/ camisas de los cilindros/ втулка цилиндра		PISTON + RINGS Kolben + Ringe/ Pistón + Anillos/ поршень и кольца		PISTON SET Kolben Set/ Pistón Set/ поршневой	RINGS SET Ring Set/ Anillos Set/ кольца		PIN Pin/ Perno/ Пин	
4N13 LANCER (CY9A CX9A) 2009- 1,799 cc 4 cyl 83.0 mm Bore Ø			Flange	No flange	Piston		Alfin and with oil gallery skirt MOS2 treated		Rings	
		Length: Outside Ø: Flange Ø: Flange depth:			Length: Comp. height:				Top: 2nd: oil:	
		Reference no.:		Reference no.:		Reference no.:	Reference no.:		Reference no.:	
NM-Motorservice Article no./ Artikelnummer/ Modelo número/ статья номер		NM-Motorservice Article no.:		NM-Motorservice Article no.:		NM-Motorservice Article no.:	NM-Motorservice Article no.:		NM-Motorservice Article no.:	
		LBS 55500 PB LBS 55500 SB		LB 55500 P LB 55500 S		KBS 55500 B	KB 55500 B		KR 55500 PB 55500	

ENGINE TYPE Motortyp/ tipo de motor/ тип двигателя	LINER KIT Liner Kit/ camisas de los cilindros/ Лайнер комплект	CYL. LINER Zylinderlaufbuchse/ camisas de los cilindros/ втулка цилиндра		PISTON + RINGS Kolben + Ringe/ Pistón + Anillos/ поршень и кольца		PISTON SET Kolben Set/ Pistón Set/ поршневой	RINGS SET Ring Set/ Anillos Set/ кольца		PIN Pin/ Perno/ Пин	
4DQ5 2,084 cc 4 cyl 84.0 mm Bore Ø			Liner/ Sleeve		Piston				Rings	
		Length: Outside Ø: Flange Ø: Flange depth:	163.0 88.0		Length: Comp. height:	92.3 45.3 -1.8			Top: 2nd: oil:	2.5 2.0 4.0
		Reference no.:		Reference no.:		Reference no.:	Reference no.:		Reference no.:	
		30607-50301				30617-57105	30615-51011 30617-51011			
NM-Motorservice Article no./ Artikelnummer/ Modelo número/ статья номер		NM-Motorservice Article no.:		NM-Motorservice Article no.:		NM-Motorservice Article no.:	NM-Motorservice Article no.:		NM-Motorservice Article no.:	
		LBS 24100 P		LB 24100 P		KBS 24100	KB 24100		KR 24100 PB 24100	

ENGINE TYPE Motortyp/ tipo de motor/ тип двигателя	LINER KIT Liner Kit/ camisas de los cilindros/ Лайнер комплект	CYL. LINER Zylinderlaufbuchse/ camisas de los cilindros/ втулка цилиндра		PISTON + RINGS Kolben + Ringe/ Pistón + Anillos/ поршень и кольца	PISTON SET Kolben Set/ Pistón Set/ поршневой	RINGS SET Ring Set/ Anillos Set/ кольца	PIN Pin/ Perno/ Пин
4N14 OUTLANDER (CW7W) 2007- 2,268 cc 4 cyl 86.0 mm Bore Ø			Liner/ Sleeve	Piston	Alfin and with oil gallery skirt MOS2 treated	Rings	Ø : Length:
		Length: Outside Ø: Flange Ø: Flange depth:					
		Reference no.:		Reference no.:	Reference no.:	Reference no.:	Reference no.:
				MN982119 MN982377		MN982121 MN982378	
NM-Motorservice Article no./ Artikelnummer/ Modelo número/ статья номер	NM-Motorservice Article no.:	NM-Motorservice Article no.:		NM-Motorservice Article no.:	NM-Motorservice Article no.:	NM-Motorservice Article no.:	NM-Motorservice Article no.:
	LBS 56500 PB LBS 56500 SB	LB 56500 P LB 56500 S		KBS 56500 B	KB 56500 B	KR 56500	PB 56500

ENGINE TYPE Motortyp/ tipo de motor/ тип двигателя	LINER KIT Liner Kit/ camisas de los cilindros/ Лайнер комплект	CYL. LINER Zylinderlaufbuchse/ camisas de los cilindros/ втулка цилиндра			PISTON + RINGS Kolben + Ringe/ Pistón + Anillos/ поршень и кольца	PISTON SET Kolben Set/ Pistón Set/ поршневой	RINGS SET Ring Set/ Anillos Set/ кольца	PIN Pin/ Perno/ Пин
4D56 2,476 cc 4 cyl 91.1 mm Bore Ø			Flanged	No flange	Piston		Rings	Ø : Length:
		Length: Outside Ø: Flange Ø: Flange depth:	165.0 94.2 98.1 2.0	165.0 94.2				
		Reference no.:				Reference no.:	Reference no.:	Reference no.:
		MD050430 MD103648				MD367335 MD304835	MD050395	MD050009
NM-Motorservice Article no./ Artikelnummer/ Modelo número/ статья номер	NM-Motorservice Article no.:	NM-Motorservice Article no.:			NM-Motorservice Article no.:	NM-Motorservice Article no.:	NM-Motorservice Article no.:	NM-Motorservice Article no.:
	LBS 24200 P LBS 24200 S	LB 24200 P LB 24200 S			KBS 24200	KB 24200	KR 24200	PB 24200

ENGINE TYPE Motortyp/ tipo de motor/ тип двигателя	LINER KIT Liner Kit/ camisas de los cilindros/ Лайнер комплект	CYL. LINER Zylinderlaufbuchse/ camisas de los cilindros/ втулка цилиндра			PISTON + RINGS Kolben + Ringe/ Pistón + Anillos/ поршень и кольца	PISTON SET Kolben Set/ Pistón Set/ поршневой	RINGS SET Ring Set/ Anillos Set/ кольца	PIN Pin/ Perno/ Пин
4D55 4D56 2,346 cc / 2,476 cc 4 cyl 91.1 mm Bore Ø			Flanged	No flange	Piston		Rings	Ø : Length:
		Length: Outside Ø: Flange Ø: Flange depth:	165.0 94.2 98.1 2.0	165.0 94.2				
		Reference no.:				Reference no.:	Reference no.:	Reference no.:
		MD050430 MD103648				MD050021 MD103318	MD050395	MD050009
NM-Motorservice Article no./ Artikelnummer/ Modelo número/ статья номер	NM-Motorservice Article no.:	NM-Motorservice Article no.:			NM-Motorservice Article no.:	NM-Motorservice Article no.:	NM-Motorservice Article no.:	NM-Motorservice Article no.:
	LBS 24250 P LBS 24250 S	LB 24250 P LB 24250 S			KBS 24250	KB 24250	KR 24250	24250 PB

ENGINE TYPE Motortyp/ tipo de motor/ тип двигателя	LINER KIT Liner Kit/ camisas de los cilindros/ Лайнер комплект	CYL. LINER Zylinderlaufbuchse/ camisas de los cilindros/ втулка цилиндра		PISTON + RINGS Kolben + Ringe/ Pistón + Anillos/ поршень и кольца	PISTON SET Kolben Set/ Pistón Set/ поршневой	RINGS SET Ring Set/ Anillos Set/ кольца	PIN Pin/ Perno/ Пин
4D56 New 2,476 cc 4 cyl 91.1 mm Bore Ø			Flanged	No flange	Piston	Rings	Ø : 29.0 Length: 75.0
		Length: Outside Ø: Flange Ø: Flange depth:	165.0 94.2 98.1 2.0	165.0 94.2 94.2			
		Reference no.:			Reference no.:	Reference no.:	Reference no.:
		MD050430 MD103648			MD304838	MD050395	MD050009
NM-Motorservice Article no./ Artikelnummer/ Modelo número/ статья номер	NM-Motorservice Article no.:	NM-Motorservice Article no.:		NM-Motorservice Article no.:	NM-Motorservice Article no.:	NM-Motorservice Article no.:	NM-Motorservice Article no.:
	LBS 24300 P LBS 24300 S	LB 24300 P LB 24300 S		KBS 24300	KB 24300	KR 24300	PB 24300



ENGINE TYPE Motortyp/ tipo de motor/ тип двигателя	LINER KIT Liner Kit/ camisas de los cilindros/ Лайнер комплект	CYL. LINER Zylinderlaufbuchse/ camisas de los cilindros/ втулка цилиндра		PISTON + RINGS Kolben + Ringe/ Pistón + Anillos/ поршень и кольца	PISTON SET Kolben Set/ Pistón Set/ поршневой	RINGS SET Ring Set/ Anillos Set/ кольца	PIN Pin/ Perno/ Пин
4D55T / 4D56T also for HYUNDAI D4BF FORD 2,346 cc / 2,476 cc 4 cyl 91.1 mm Bore Ø			Flanged	No flange	Piston	Rings	Ø : 29.0 Length: 75.0
		Length: Outside Ø: Flange Ø: Flange depth:	165.0 94.2 98.1 2.0	165.0 94.2 94.2			
		Reference no.:			Reference no.:	Reference no.:	Reference no.:
		MD050430 MD103648			MD050011 MD103308	1110A561 1110A562 1110A563 MD050390 MD103391	MD050009
NM-Motorservice Article no./ Artikelnummer/ Modelo número/ статья номер	NM-Motorservice Article no.:	NM-Motorservice Article no.:		NM-Motorservice Article no.:	NM-Motorservice Article no.:	NM-Motorservice Article no.:	NM-Motorservice Article no.:
	LBS Mi 18000 PA LBS Mi 18000 SA LBS Hd 18000 PA LBS Hd 18000 SA	LB Mi 18000 P LB Mi 18000 S LB Hd 18000 P LB Hd 18000 S		KBS Mi 18000 A KBS Hd 18000 A	KB Mi 18000 A KB Hd 18000 A	KR Mi 18000 KR Hd 18000	PB Mi 18000 PB Hd 18000



ENGINE TYPE Motortyp/ tipo de motor/ тип двигателя	LINER KIT Liner Kit/ camisas de los cilindros/ Лайнер комплект	CYL. LINER Zylinderlaufbuchse/ camisas de los cilindros/ втулка цилиндра		PISTON + RINGS Kolben + Ringe/ Pistón + Anillos/ поршень и кольца	PISTON SET Kolben Set/ Pistón Set/ поршневой	RINGS SET Ring Set/ Anillos Set/ кольца	PIN Pin/ Perno/ Пин
4D55T (L/R) 4D56T (L/R) 2,346 cc / 2,476 cc 4 cyl 91.1 mm Bore Ø			Flanged	No flange	Piston	Rings	Ø : 29.0 Length: 75.0
		Length: Outside Ø: Flange Ø: Flange depth:	165.0 94.2 98.1 2.0	165.0 94.2 94.2			
		Reference no.:			Reference no.:	Reference no.:	Reference no.:
		MD050430 MD103648			MD182601 MD182607 (L/R)	1110A561 1110A562 1110A563 MD050390 MD103391	MD050009
NM-Motorservice Article no./ Artikelnummer/ Modelo número/ статья номер	NM-Motorservice Article no.:	NM-Motorservice Article no.:		NM-Motorservice Article no.:	NM-Motorservice Article no.:	NM-Motorservice Article no.:	NM-Motorservice Article no.:
	LBS 18001 PB LBS 18001 SB	LB 18001 P LB 18001 S		KBS 18001 B	KB 18001 B	KR 18001	PB 18001



ENGINE TYPE Motortyp/ tipo de motor/ тип двигателя	LINER KIT Liner Kit/ camisas de los cilindros/ Лайнер комплект	CYL. LINER Zylinderlaufbuchse/ camisas de los cilindros/ втулка цилиндра		PISTON + RINGS Kolben + Ringe/ Pistón + Anillos/ поршень и кольца		PISTON SET Kolben Set/ Pistón Set/ поршневой	RINGS SET Ring Set/ Anillos Set/ кольца		PIN Pin/ Perno/ Пин	
4D56T 2,476 cc 4 cyl 91.1 mm Bore Ø			Flanged	No flange	Piston		Rings			
		Length: Outside Ø: Flange Ø: Flange depth:	165.0 94.2 98.1 2.0	165.0 94.2	Length: Comp. height:	88.7 48.7 -1.3 -2.6	Top: 2nd: oil:	2.5 2.0 4.0	Ø: Length:	29.0 75.0
	Reference no.:				Reference no.:	Reference no.:	Reference no.:		Reference no.:	
	MD050430 MD103648				MD304850	1110A561 1110A562 1110A563 MD050390 MD103391	MD050009			
NM-Motorservice Article no./ Artikelnummer/ Modelo número/ статья номер	NM-Motorservice Article no.:	NM-Motorservice Article no.:		NM-Motorservice Article no.:		NM-Motorservice Article no.:	NM-Motorservice Article no.:	NM-Motorservice Article no.:		NM-Motorservice Article no.:
	LBS 24450 PA LBS 24450 SA	LB 24450 P LB 24450 S		KBS 24450 A		KB 24450 A	KR 24450	PB 24450		

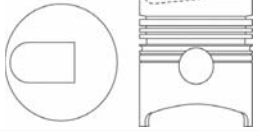

ENGINE TYPE Motortyp/ tipo de motor/ тип двигателя	LINER KIT Liner Kit/ camisas de los cilindros/ Лайнер комплект	CYL. LINER Zylinderlaufbuchse/ camisas de los cilindros/ втулка цилиндра		PISTON + RINGS Kolben + Ringe/ Pistón + Anillos/ поршень и кольца		PISTON SET Kolben Set/ Pistón Set/ поршневой	RINGS SET Ring Set/ Anillos Set/ кольца		PIN Pin/ Perno/ Пин	
4D56T New (L/R) 2,476 cc 4 cyl 91.1 mm Bore Ø			Flanged	No flange	Piston		Alfin and with oil gallery		Rings	
		Length: Outside Ø: Flange Ø: Flange depth:	165.0 94.2 98.1 2.0	165.0 94.2	Length: Comp. height:	88.7 48.7 -2.3	Top: 2nd: oil:	2.5 2.0 4.0	Ø: Length:	29.0 75.0
	Reference no.:				Reference no.:	Reference no.:	Reference no.:		Reference no.:	
	MD050430 MD103648				MD304853 MD304859 (L/R)	1110A561 1110A562 1110A563 MD050390 MD103391	MD050009			
NM-Motorservice Article no./ Artikelnummer/ Modelo número/ статья номер	NM-Motorservice Article no.:	NM-Motorservice Article no.:		NM-Motorservice Article no.:		NM-Motorservice Article no.:	NM-Motorservice Article no.:	NM-Motorservice Article no.:		NM-Motorservice Article no.:
	LBS 44500 PB LBS 44500 SB	LB 44500 P LB 44500 S		KBS 44500 B		KB 44500 B	KR 44500	PB 44500		

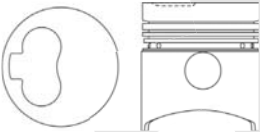

ENGINE TYPE Motortyp/ tipo de motor/ тип двигателя	LINER KIT Liner Kit/ camisas de los cilindros/ Лайнер комплект	CYL. LINER Zylinderlaufbuchse/ camisas de los cilindros/ втулка цилиндра		PISTON + RINGS Kolben + Ringe/ Pistón + Anillos/ поршень и кольца		PISTON SET Kolben Set/ Pistón Set/ поршневой	RINGS SET Ring Set/ Anillos Set/ кольца		PIN Pin/ Perno/ Пин	
4D57 also for HYUNDAI D4BB 2,607 cc 4 cyl 91.1 mm Bore Ø			Flanged	No flange	Piston		Alfin skirt MOS2 treated		Rings	
		Length: Outside Ø: Flange Ø: Flange depth:	165.0 94.2 98.1 2.0	165.0 94.2	Length: Comp. height:	76.2 46.2 -2.2 -3.4	Top: 2nd: oil:	2.0 2.0 3.0	Ø: Length:	29.0 75.0
	Reference no.:				Reference no.:	Reference no.:	Reference no.:		Reference no.:	
	MD050430 MD103648					23040-42200 23040-42202 23040-42210	MD050009			
NM-Motorservice Article no./ Artikelnummer/ Modelo número/ статья номер	NM-Motorservice Article no.:	NM-Motorservice Article no.:		NM-Motorservice Article no.:		NM-Motorservice Article no.:	NM-Motorservice Article no.:	NM-Motorservice Article no.:		NM-Motorservice Article no.:
	LBS Mi 24550 PA LBS Mi 24550 SA LBS Hd 24550 PA LBS Hd 24550 SA	LB Mi 24550 P LB Mi 24550 S LB Hd 24550 P LB Hd 24550 S		KBS Mi 24550 A KBS Hd 24550 A		KB Mi 24550 A KB Hd 24550 A	KR Mi 24550 KR Hd 24550	PB Mi 24550 PB Hd 24550		



ENGINE TYPE Motortyp/ tipo de motor/ тип двигателя	LINER KIT Liner Kit/ camisas de los cilindros/ Лайнер комплект	CYL. LINER Zylinderlaufbuchse/ camisas de los cilindros/ втулка цилиндра		PISTON + RINGS Kolben + Ringe/ Pistón + Anillos/ поршень и кольца		PISTON SET Kolben Set/ Pistón Set/ поршневой	RINGS SET Ring Set/ Anillos Set/ кольца		PIN Pin/ Perno/ Пин	
4D56T (L/R) 2,476 cc 4 cyl 91.1 mm Bore Ø			Flanged	No flange	Piston		Alfin and with oil gallery head anodized	Rings		
		Length: Outside Ø: Flange Ø: Flange depth:	165.0 94.2 98.1 2.0	165.0 94.2 94.2	Length: Comp. height:	78.7 48.7 -1.3 -2.6		Top: 2nd: oil:	2.5 2.0 4.0	Ø: Length:
		Reference no.:				Reference no.:	Reference no.:		Reference no.:	
		MD050430 MD103648				MD377962 MD377963 MD377965 MD377966 MR984128 MR984130 (L / R)	1110A561 1110A562 1110A563 MD050390 MD103391			
NM-Motorservice Article no./ Artikelnummer/ Modelo número/ статья номер	NM-Motorservice Article no.:	NM-Motorservice Article no.:		NM-Motorservice Article no.:		NM-Motorservice Article no.:	NM-Motorservice Article no.:		NM-Motorservice Article no.:	
	LBS 24600 APB LBS 24600 ASB	LB 24600 P LB 24600 S		KBS 24600 B		KB 24600 B	KR 24600		PB 24600	
4D56T CRDi (L/R) New L200 16V 2,476 cc 4 cyl 91.1 mm Bore Ø			Flanged	No flange	Piston		alfin and with oil gallery head anodized skirt MOS2 treated	Rings		
		Length: Outside Ø: Flange Ø: Flange depth:	165.0 94.2 98.1 2.0	165.0 94.2 94.2	Length: Comp. height:	78.2 48.2 -4.0 -19.0		Top: 2nd: oil:	2.5 2.0 4.0	Ø: Length:
		Reference no.:				Reference no.:	Reference no.:		Reference no.:	
		MD050430 MD103648				1110A593 1110A594 1110A595 1110A596 1110A597 1110A598 1110A599 1110A600 1110A601 1110A602 (L / R)	1110A561 1110A562 1110A563 MD050390 MD103391			
NM-Motorservice Article no./ Artikelnummer/ Modelo número/ статья номер	NM-Motorservice Article no.:	NM-Motorservice Article no.:		NM-Motorservice Article no.:		NM-Motorservice Article no.:	NM-Motorservice Article no.:		NM-Motorservice Article no.:	
	LBS 67000 BPB LBS 67000 BSB	LB 67000 P LB 67000 S		KBS 67000 B		KB 67000 B	KR 67000		PB 67000	
4D55T (L/R) 4D56T (L/R) 2,476 cc 4 cyl 91.1 mm Bore Ø			Flanged	No flange	Piston		Alfin and with oil gallery head anodized	Rings		
		Length: Outside Ø: Flange Ø: Flange depth:	165.0 94.2 98.1 2.0	165.0 94.2 94.2	Length: Comp. height:	78.2 48.2 -4.0 -19.0		Top: 2nd: oil:	2.5 2.0 3.0	Ø: Length:
		Reference no.:				Reference no.:	Reference no.:		Reference no.:	
		MD050430 MD103648				1110C313 1110C314 1110C315 1110C316 1110C317 (L/R)				
NM-Motorservice Article no./ Artikelnummer/ Modelo número/ статья номер	NM-Motorservice Article no.:	NM-Motorservice Article no.:		NM-Motorservice Article no.:		NM-Motorservice Article no.:	NM-Motorservice Article no.:		NM-Motorservice Article no.:	
	LBS 24700 CPB LBS 24700 CSB	LB 24700 P LB 24700 S		KBS 24700 B		KB 24700 B	KR 24700		PB 24700	

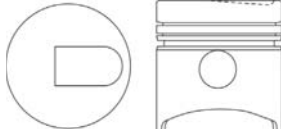

ENGINE TYPE Motortyp/ tipo de motor/ тип двигателя	LINER KIT Liner Kit/ camisas de los cilindros/ Лайнер комплект	CYL. LINER Zylinderlaufbuchse/ camisas de los cilindros/ втулка цилиндра		PISTON + RINGS Kolben + Ringe/ Pistón + Anillos/ поршень и кольца		PISTON SET Kolben Set/ Pistón Set/ поршневой	RINGS SET Ring Set/ Anillos Set/ кольца		PIN Pin/ Perno/ Пин	
4DR5 2,659 cc 4 cyl 92.0 mm Bore Ø			Liner/ Sleeve	Piston			Rings		Ø : Length:	28.0 77.0
		Length: Outside Ø: Flange Ø: Flange depth:	176.0 95.0	Length: Comp. height:	99.5 52.5 -3.6		Top: 2nd: 3rd: oil:	2.5 2.0 2.0 4.5		
		Reference no.:				Reference no.:	Reference no.:	Reference no.:		
		31607-02202				31617-00106	31617-02012 31617-02013 31617-05102 31617-05103 ME999073	31619-00700 31619-00792		
NM-Motorservice Article no./ Artikelnummer/ Modelo número/ статья номер	NM-Motorservice Article no.:	NM-Motorservice Article no.:		NM-Motorservice Article no.:		NM-Motorservice Article no.:	NM-Motorservice Article no.:	NM-Motorservice Article no.:		
	LBS 24750 P	LB 24750 P		KBS 24750		KB 24750	KR 24750	PB 24750		

ENGINE TYPE Motortyp/ tipo de motor/ тип двигателя	LINER KIT Liner Kit/ camisas de los cilindros/ Лайнер комплект	CYL. LINER Zylinderlaufbuchse/ camisas de los cilindros/ втулка цилиндра		PISTON + RINGS Kolben + Ringe/ Pistón + Anillos/ поршень и кольца		PISTON SET Kolben Set/ Pistón Set/ поршневой	RINGS SET Ring Set/ Anillos Set/ кольца		PIN Pin/ Perno/ Пин	
4DR5 4DR51 2,659 cc 4 cyl 92.0 mm Bore Ø			Liner/ Sleeve	Piston			Rings		Ø : Length:	28.0 77.0
		Length: Outside Ø: Flange Ø: Flange depth:	176.0 95.0	Length: Comp. height:	99.7 52.7 -2.6		Top: 2nd: 3rd: oil:	2.5 2.0 2.0 4.5		
		Reference no.:				Reference no.:	Reference no.:	Reference no.:		
		31607-02202				MD002044 ME002044	31617-02012 31617-02013 31617-05102 31617-05103 ME999073	31619-00700 31619-00792		
NM-Motorservice Article no./ Artikelnummer/ Modelo número/ статья номер	NM-Motorservice Article no.:	NM-Motorservice Article no.:		NM-Motorservice Article no.:		NM-Motorservice Article no.:	NM-Motorservice Article no.:	NM-Motorservice Article no.:		
	LBS 24800 P	LB 24800 P		KBS 24800		KB 24800	KR 24800	PB 24800		

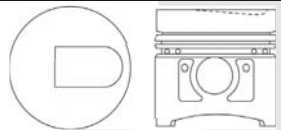
ENGINE TYPE Motortyp/ tipo de motor/ тип двигателя	LINER KIT Liner Kit/ camisas de los cilindros/ Лайнер комплект	CYL. LINER Zylinderlaufbuchse/ camisas de los cilindros/ втулка цилиндра		PISTON + RINGS Kolben + Ringe/ Pistón + Anillos/ поршень и кольца		PISTON SET Kolben Set/ Pistón Set/ поршневой	RINGS SET Ring Set/ Anillos Set/ кольца		PIN Pin/ Perno/ Пин	
4DR5 New 2,659 cc 4 cyl 92.0 mm Bore Ø			Liner/ Sleeve	Piston			Rings		Ø : Length:	28.0 77.0
		Length: Outside Ø: Flange Ø: Flange depth:	176.0 95.0	Length: Comp. height:	99.7 52.7 -2.6		Top: 2nd: 3rd: oil:	2.5 2.0 2.0 4.5		
		Reference no.:				Reference no.:	Reference no.:	Reference no.:		
		31607-02202				ME002117	31617-02012 31617-02013 31617-05102 31617-05103 ME999073	31619-00700 31619-00792		
NM-Motorservice Article no./ Artikelnummer/ Modelo número/ статья номер	NM-Motorservice Article no.:	NM-Motorservice Article no.:		NM-Motorservice Article no.:		NM-Motorservice Article no.:	NM-Motorservice Article no.:	NM-Motorservice Article no.:		
	LBS 24850 P	LB 24850 P		KBS 24850		KB 24850	KR 24850	PB 24850		

ENGINE TYPE Motortyp/ tipo de motor/ тип двигателя	LINER KIT Liner Kit/ camisas de los cilindros/ Лайнер комплект	CYL. LINER Zylinderlaufbuchse/ camisas de los cilindros/ втулка цилиндра		PISTON + RINGS Kolben + Ringe/ Pistón + Anillos/ поршень и кольца		PISTON SET Kolben Set/ Pistón Set/ поршневой	RINGS SET Ring Set/ Anillos Set/ кольца		PIN Pin/ Perno/ Пин	
S4E			Liner/ Sleeve	Piston			Rings		Ø: Length:	28.0 77.0
		Length: Outside Ø: Flange Ø: Flange depth:	165.0 98.0	Length: Comp. height:	98.5 51.5 -3.5		Top: 2nd: oil:	2.5 2.0 4.5		
2,610 cc 4 cyl 94.0 mm Bore Ø		Reference no.:		Reference no.:		Reference no.:	Reference no.:		Reference no.:	
		34407-00301				34417-04101 34417-20101	34417-11011 34417-02012	31619-00700 31619-00792		
NM-Motorservice Article no./ Artikelnummer/ Modelo número/ статья номер	NM-Motorservice Article no.:	NM-Motorservice Article no.:		NM-Motorservice Article no.:		NM-Motorservice Article no.:	NM-Motorservice Article no.:	NM-Motorservice Article no.:		NM-Motorservice Article no.:
	LBS 24900 P	LB 24900 P		KBS 24900		KB 24900	KR 24900	PB 24900		







ENGINE TYPE Motortyp/ tipo de motor/ тип двигателя	LINER KIT Liner Kit/ camisas de los cilindros/ Лайнер комплект	CYL. LINER Zylinderlaufbuchse/ camisas de los cilindros/ втулка цилиндра		PISTON + RINGS Kolben + Ringe/ Pistón + Anillos/ поршень и кольца		PISTON SET Kolben Set/ Pistón Set/ поршневой	RINGS SET Ring Set/ Anillos Set/ кольца		PIN Pin/ Perno/ Пин	
S4E1			Liner/ Sleeve	Piston			Rings		Ø: Length:	28.0 77.0
		Length: Outside Ø: Flange Ø: Flange depth:	165.0 98.0	Length: Comp. height:	90.1 51.5 -3.5		Top: 2nd: oil:	2.5 2.0 4.5		
2,610 cc cyl 94.0 mm Bore Ø		Reference no.:		Reference no.:		Reference no.:	Reference no.:		Reference no.:	
		34407-00301					34417-11011 34417-02012	31619-00700 31619-00792		
NM-Motorservice Article no./ Artikelnummer/ Modelo número/ статья номер	NM-Motorservice Article no.:	NM-Motorservice Article no.:		NM-Motorservice Article no.:		NM-Motorservice Article no.:	NM-Motorservice Article no.:	NM-Motorservice Article no.:		NM-Motorservice Article no.:
	LBS 24950 P	LB 24950 P		KBS 24950		KB 24950	KR 24950	PB 24950		

ENGINE TYPE Motortyp/ tipo de motor/ тип двигателя	LINER KIT Liner Kit/ camisas de los cilindros/ Лайнер комплект	CYL. LINER Zylinderlaufbuchse/ camisas de los cilindros/ втулка цилиндра		PISTON + RINGS Kolben + Ringe/ Pistón + Anillos/ поршень и кольца		PISTON SET Kolben Set/ Pistón Set/ поршневой	RINGS SET Ring Set/ Anillos Set/ кольца		PIN Pin/ Perno/ Пин		
S4S			Flanged	No flange	Piston			Rings		Ø: Length:	30.0 76.5
		Length: Outside Ø: Flange Ø: Flange depth:	185.0 98.0 101.9 4.0	190.0 98.0	Length: Comp. height:	89.8 55.0 -4.5		Top: 2nd: oil:	2.5 2.0 4.5		
3,331 cc 4 cyl 94.0 mm Bore Ø		Reference no.:		Reference no.:		Reference no.:	Reference no.:		Reference no.:		
		32A07-00300				32A17-00100	34417-11011 34417-02012				
NM-Motorservice Article no./ Artikelnummer/ Modelo número/ статья номер	NM-Motorservice Article no.:	NM-Motorservice Article no.:		NM-Motorservice Article no.:		NM-Motorservice Article no.:	NM-Motorservice Article no.:	NM-Motorservice Article no.:		NM-Motorservice Article no.:	
	LBS 39950 P LBS 39950 S	LB 39950 P LB 39950 S		KBS 39950		KB 39950	KR 39950	PB 39950			

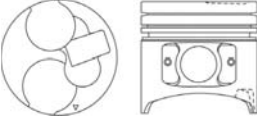
ENGINE TYPE Motortyp/ tipo de motor/ тип двигателя	LINER KIT Liner Kit/ camisas de los cilindros/ Лайнер комплект	CYL. LINER Zylinderlaufbuchse/ camisas de los cilindros/ втулка цилиндра		PISTON + RINGS Kolben + Ringe/ Pistón + Anillos/ поршень и кольца		PISTON SET Kolben Set/ Pistón Set/ поршневой	RINGS SET Ring Set/ Anillos Set/ кольца		PIN Pin/ Perno/ Пин
4DR7			Liner/ Sleeve	Piston			Rings		Ø : 30.0 Length: 78.0
		Length: Outside Ø: Flange Ø: Flange depth:	180.0 98.0	Length: Comp. height:	94.6 52.6 -2.2		Top: 2nd: oil:	2.3 2.0 4.0	
2,835 cc 4 cyl 95.0 mm Bore Ø		Reference no.:		Reference no.:		Reference no.:	Reference no.:		Reference no.:
		ME997798				ME021861	ME201522 ME202342 ME202380 ME202950 ME997256 ME997894		ME201016
NM-Motorservice Article no./ Artikelnummer/ Modelo número/ статья номер	NM-Motorservice Article no.:	NM-Motorservice Article no.:		NM-Motorservice Article no.:		NM-Motorservice Article no.:	NM-Motorservice Article no.:		NM-Motorservice Article no.:
	LBS 25050 P	LB 25050 P		KBS 25050		KB 25050	KR 25050		PB 25050

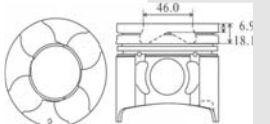
ENGINE TYPE Motortyp/ tipo de motor/ тип двигателя	LINER KIT Liner Kit/ camisas de los cilindros/ Лайнер комплект	CYL. LINER Zylinderlaufbuchse/ camisas de los cilindros/ втулка цилиндра			PISTON + RINGS Kolben + Ringe/ Pistón + Anillos/ поршень и кольца		PISTON SET Kolben Set/ Pistón Set/ поршневой	RINGS SET Ring Set/ Anillos Set/ кольца		PIN Pin/ Perno/ Пин
4M40			Flanged	No flange	Piston		Alfin Head anodized	Rings		Ø : 30.0 Length: 77.9
		Length: Outside Ø: Flange Ø: Flange depth:	186.0 99.0 104.6 2.5	186.0 99.0	Length: Comp. height:	91.7 51.7 -1.3 -3.0		Top: 2nd: oil:	2.3 2.0 4.0	
2,835 cc 4 cyl 95.0 mm Bore Ø		Reference no.:			Reference no.:		Reference no.:	Reference no.:		Reference no.:
		MD168963 ME200685 ME999919					ME200680 ME200681 ME200682 ME201780 ME201781 ME201782	ME201522 ME202342 ME202380 ME202950 ME997256 ME997894		ME201016
NM-Motorservice Article no./ Artikelnummer/ Modelo número/ статья номер	NM-Motorservice Article no.:	NM-Motorservice Article no.:			NM-Motorservice Article no.:		NM-Motorservice Article no.:	NM-Motorservice Article no.:		NM-Motorservice Article no.:
	LBS 42000 PA LBS 42000 SA	LB 42000 P LB 42000 S			KBS 42000 A		KB 42000 A	KR 42000		PB 42000

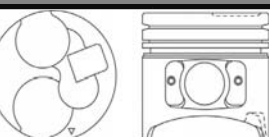

ENGINE TYPE Motortyp/ tipo de motor/ тип двигателя	LINER KIT Liner Kit/ camisas de los cilindros/ Лайнер комплект	CYL. LINER Zylinderlaufbuchse/ camisas de los cilindros/ втулка цилиндра			PISTON + RINGS Kolben + Ringe/ Pistón + Anillos/ поршень и кольца		PISTON SET Kolben Set/ Pistón Set/ поршневой	RINGS SET Ring Set/ Anillos Set/ кольца		PIN Pin/ Perno/ Пин
4M40T			Flanged	No flange	Piston		Alfin and with oil gallery head anodized	Rings		Ø : 30.0 Length: 77.9
		Length: Outside Ø: Flange Ø: Flange depth:	186.0 99.0 104.6 2.5	186.0 99.0	Length: Comp. height:	91.6 51.6 -3.0		Top: 2nd: oil:	2.3 2.0 3.0	
2,835 cc 4 cyl 95.0 mm Bore Ø		Reference no.:			Reference no.:		Reference no.:	Reference no.:		Reference no.:
		MD168963 ME200685 ME999919					ME203223 ME203224 ME203225	ME190317 ME202148		ME201016
NM-Motorservice Article no./ Artikelnummer/ Modelo número/ статья номер	NM-Motorservice Article no.:	NM-Motorservice Article no.:			NM-Motorservice Article no.:		NM-Motorservice Article no.:	NM-Motorservice Article no.:		NM-Motorservice Article no.:
	LBS 25550 PB LBS 25550 SB	LB 25550 P LB 25550 S			KBS 25550 B		KB 25550 B	KR 25550		PB 25550



ENGINE TYPE Motortyp/ tipo de motor/ тип двигателя	LINER KIT Liner Kit/ camisas de los cilindros/ Лайнер комплект	CYL. LINER Zylinderlaufbuchse/ camisas de los cilindros/ втулка цилиндра		PISTON + RINGS Kolben + Ringe/ Pistón + Anillos/ поршень и кольца	PISTON SET Kolben Set/ Pistón Set/ поршневой	RINGS SET Ring Set/ Anillos Set/ кольца	PIN Pin/ Perno/ Пин	
4M40 New 2,835 cc 4 cyl 95.0 mm Bore Ø		Flanged	No flange	Piston		Rings		Ø : 30.0 Length: 78.0
		Length: 186.0 Outside Ø: 99.0 Flange Ø: 104.6 Flange depth: 2.5	186.0 99.0	Length: 91.6 Comp. height: 51.6 -0.7 -3.0	Alfin and with oil gallery head anodized		Top: 2.3 2nd: 2.0 oil: 4.0	
		Reference no.:			Reference no.:	Reference no.:	Reference no.:	
		MD168963 ME200685 ME999919			ME200688 ME200689 ME200690 ME204029 ME204030	ME201522 ME202342 ME202380 ME202950 ME997256 ME997894	ME201016	
NM-Motorservice Article no./ Artikelnummer/ Modelo número/ статья номер	NM-Motorservice Article no.:	NM-Motorservice Article no.:		NM-Motorservice Article no.:	NM-Motorservice Article no.:	NM-Motorservice Article no.:	NM-Motorservice Article no.:	
	LBS 42000 PB LBS 42000 SB	LB 42000 P LB 42000 S		KBS 42000 B	KB 42000 B	KR 42000	PB 42000	
4M42-0AT 2,977 cc 4 cyl 95.0 mm Bore Ø		Flanged	No flange	Piston		Rings		Ø : 30.0 Length: 78.0
		Length: 186.0 Outside Ø: 99.0 Flange Ø: 104.6 Flange depth: 2.5	186.0 99.0	Length: 87.0 Comp. height: 47.0 -6.9 -18.1	Alfin and with oil gallery		Top: 2.3 2nd: 2.0 oil: 3.0	
		Reference no.:			Reference no.:	Reference no.:	Reference no.:	
								
NM-Motorservice Article no./ Artikelnummer/ Modelo número/ статья номер	NM-Motorservice Article no.:	NM-Motorservice Article no.:		NM-Motorservice Article no.:	NM-Motorservice Article no.:	NM-Motorservice Article no.:	NM-Motorservice Article no.:	
	LBS 96000 PB LBS 96000 SB	LB 96000 P LB 96000 S		KBS 96000 B	KB 96000 B	KR 96000	PB 96000	
4M40 2,835 cc 4 cyl 95.0 mm Bore Ø	LB 25300-2 S Length: 181.0 Outside Ø: 98.0 Flange Ø: 101.9 Flange depth: 4.0	Flanged	No flange	Piston		Rings		Ø : 30.0 Length: 77.9
		Length: 186.0 Outside Ø: 99.0 Flange Ø: 104.6 Flange depth: 2.5	186.0 99.0	Length: 91.7 Comp. height: 51.7 -1.3 -3.0	Alfin head anodized		Top: 2.3 2nd: 2.0 oil: 3.0	
		Reference no.:			Reference no.:	Reference no.:	Reference no.:	
		MD168963 ME200685 ME999919			ME204402	ME190317 ME202148	ME201016	
NM-Motorservice Article no./ Artikelnummer/ Modelo número/ статья номер	NM-Motorservice Article no.:	NM-Motorservice Article no.:		NM-Motorservice Article no.:	NM-Motorservice Article no.:	NM-Motorservice Article no.:	NM-Motorservice Article no.:	
	LBS 25300 PA LBS 25300 SA	LB 25300 P LB 25300 S LB 25300-2 S		KBS 25300 A	KB 25300 A	KR 25300	PB 25300	

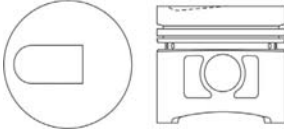

ENGINE TYPE Motortyp/ tipo de motor/ тип двигателя	LINER KIT Liner Kit/ camisas de los cilindros/ Лайнер комплект	CYL. LINER Zylinderlaufbuchse/ camisas de los cilindros/ втулка цилиндра		PISTON + RINGS Kolben + Ringe/ Pistón + Anillos/ поршень и кольца		PISTON SET Kolben Set/ Pistón Set/ поршневой	RINGS SET Ring Set/ Anillos Set/ кольца		PIN Pin/ Perno/ Пин		
4M42 2,977 cc 4 cyl 95.0 mm Bore Ø	LB 25350-2 S Length: 181.0 Outside Ø: 98.0 Flange Ø: 101.9 Flange depth: 4.0		Flanged	No flange	Piston		Alfin and with oil gallery skirt MOS2 treated		Rings		
		Length: 186.0 Outside Ø: 99.0 Flange Ø: 104.6 Flange depth: 2.5	186.0 99.0	77.0 51.0 -3.5 -17.0	Top: 2.3 2nd: 2.0 oil: 3.0	Ø: 32.0 Length: 80.0					
		Reference no.:			Reference no.:	Reference no.:	Reference no.:		Reference no.:		
		MD168963 ME200685 ME999919			ME193937 ME193939	ME190317 ME202148	ME203868				
NM-Motorservice Article no./ Artikelnummer/ Modelo número/ статья номер	NM-Motorservice Article no.:	NM-Motorservice Article no.:		NM-Motorservice Article no.:		NM-Motorservice Article no.:	NM-Motorservice Article no.:	NM-Motorservice Article no.:		NM-Motorservice Article no.:	
	LBS 25350 PB LBS 25350 DB	LB 25350 P LB 25350 S		KBS 25350 B		KB 25350 B	KR 25350	PB 25350			

ENGINE TYPE Motortyp/ tipo de motor/ тип двигателя	LINER KIT Liner Kit/ camisas de los cilindros/ Лайнер комплект	CYL. LINER Zylinderlaufbuchse/ camisas de los cilindros/ втулка цилиндра		PISTON + RINGS Kolben + Ringe/ Pistón + Anillos/ поршень и кольца		PISTON SET Kolben Set/ Pistón Set/ поршневой	RINGS SET Ring Set/ Anillos Set/ кольца		PIN Pin/ Perno/ Пин		
S4E2 2,960 cc 4 cyl 98.0 mm Bore Ø			Flanged	No flange	Piston		Rings				
		Length: 170.0 Outside Ø: 101.0 Flange Ø: 103.0 Flange depth: 4.0	170.0 101.0 103.0	168.5 102.0	98.5 51.5 -3.2	Top: 3.0 2nd: 2.0 oil: 5.0	Ø: 28.0 Length: 77.0				
		Reference no.:			Reference no.:	Reference no.:	Reference no.:		Reference no.:		
		34407-00500 34407-05400			34417-54100	34417-09012					
NM-Motorservice Article no./ Artikelnummer/ Modelo número/ статья номер	NM-Motorservice Article no.:	NM-Motorservice Article no.:		NM-Motorservice Article no.:		NM-Motorservice Article no.:	NM-Motorservice Article no.:	NM-Motorservice Article no.:		NM-Motorservice Article no.:	
	LBS 25400 P LBS 25400 S	LB 25400 P LB 25400 S		KBS 25400		KB 25400	KR 25400	PB 25400			

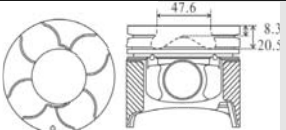
ENGINE TYPE Motortyp/ tipo de motor/ тип двигателя	LINER KIT Liner Kit/ camisas de los cilindros/ Лайнер комплект	CYL. LINER Zylinderlaufbuchse/ camisas de los cilindros/ втулка цилиндра		PISTON + RINGS Kolben + Ringe/ Pistón + Anillos/ поршень и кольца		PISTON SET Kolben Set/ Pistón Set/ поршневой	RINGS SET Ring Set/ Anillos Set/ кольца		PIN Pin/ Perno/ Пин		
S4F 2,955 cc 4 cyl 98.0 mm Bore Ø			Liner/ Sleeve		Piston		Rings				
		Length: 168.5 Outside Ø: 102.0 Flange Ø: Flange depth:	168.5 102.0	96.5 57.6 -14.5 -18.2	Top: 3.0 2nd: 2.0 oil: 5.0	Ø: 32.0 Length: 78.0					
		Reference no.:			Reference no.:	Reference no.:	Reference no.:		Reference no.:		
		34407-00500 34407-05400			36717-41100	34417-09012					
NM-Motorservice Article no./ Artikelnummer/ Modelo número/ статья номер	NM-Motorservice Article no.:	NM-Motorservice Article no.:		NM-Motorservice Article no.:		NM-Motorservice Article no.:	NM-Motorservice Article no.:	NM-Motorservice Article no.:		NM-Motorservice Article no.:	
	LBS 25450 P LBS 25450 PA	LB 25450 P		KBS 25450 KBS 25450 A		KB 25450 KB 25450 A	KR 25450	PB 25450			

ENGINE TYPE Motortyp/ tipo de motor/ тип двигателя	LINER KIT Liner Kit/ camisas de los cilindros/ Лайнер комплект	CYL. LINER Zylinderlaufbuchse/ camisas de los cilindros/ втулка цилиндра		PISTON + RINGS Kolben + Ringe/ Pistón + Anillos/ поршень и кольца		PISTON SET Kolben Set/ Pistón Set/ поршневой	RINGS SET Ring Set/ Anillos Set/ кольца		PIN Pin/ Perno/ Пин	
S4E2 2,960 cc 4 cyl 98.0 mm Bore Ø			Flanged	No flange	Piston		Rings			
		Length: Outside Ø: Flange Ø: Flange depth:	170.0 101.0 103.0 4.0	168.5 102.0	Length: Comp. height:	90.0 51.5 -3.4	Top: 2nd: oil:	3.0 2.0 5.0	Ø: Length:	28.0 77.0
		Reference no.:				Reference no.:	Reference no.:	Reference no.:		
		34407-00500 34407-05400								
NM-Motorservice Article no./ Artikelnummer/ Modelo número/ статья номер	NM-Motorservice Article no.:	NM-Motorservice Article no.:		NM-Motorservice Article no.:		NM-Motorservice Article no.:	NM-Motorservice Article no.:	NM-Motorservice Article no.:		
	LBS 44350 P LBS 44350 S	LB 44350 P LB 44350 S		KBS 44350		KB 44350	KR 44350	PB 44350		

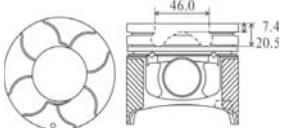

ENGINE TYPE Motortyp/ tipo de motor/ тип двигателя	LINER KIT Liner Kit/ camisas de los cilindros/ Лайнер комплект	CYL. LINER Zylinderlaufbuchse/ camisas de los cilindros/ втулка цилиндра		PISTON + RINGS Kolben + Ringe/ Pistón + Anillos/ поршень и кольца		PISTON SET Kolben Set/ Pistón Set/ поршневой	RINGS SET Ring Set/ Anillos Set/ кольца		PIN Pin/ Perno/ Пин	
4M41 4M41T 3,200 cc 4 cyl 98.5 mm Bore Ø			Flanged	No flange	Piston		Rings			
		Length: Outside Ø: Flange Ø: Flange depth:	170.5 102.5 105.5 4.0	170.5 102.5	Length: Comp. height:	87.0 47.0 -8.3 -20.5	Alfin and with oil gallery head anodized skirt MOS2 treated	Top: 2nd: oil:	2.3 1.5 3.0	Ø: Length:
		Reference no.:				Reference no.:	Reference no.:	Reference no.:		
						ME191469 ME191470 ME191471	ME203533	ME203868		
NM-Motorservice Article no./ Artikelnummer/ Modelo número/ статья номер	NM-Motorservice Article no.:	NM-Motorservice Article no.:		NM-Motorservice Article no.:		NM-Motorservice Article no.:	NM-Motorservice Article no.:	NM-Motorservice Article no.:		
	LBS 19000 PB LBS 19000 SB	LB 19000 P LB 19000 S		KBS 19000 B		KB 19000 B	KR 19000	PB 19000		



ENGINE TYPE Motortyp/ tipo de motor/ тип двигателя	LINER KIT Liner Kit/ camisas de los cilindros/ Лайнер комплект	CYL. LINER Zylinderlaufbuchse/ camisas de los cilindros/ втулка цилиндра		PISTON + RINGS Kolben + Ringe/ Pistón + Anillos/ поршень и кольца		PISTON SET Kolben Set/ Pistón Set/ поршневой	RINGS SET Ring Set/ Anillos Set/ кольца		PIN Pin/ Perno/ Пин	
4M41 4M41T 3,200 cc 4 cyl 98.5 mm Bore Ø			Flanged	No flange	Piston		Rings			
		Length: Outside Ø: Flange Ø: Flange depth:	170.5 102.5 105.5 4.0	170.5 102.5	Length: Comp. height:	87.0 47.0 -7.4 -20.5	Alfin and with oil gallery head anodized skirt MOS2 treated	Top: 2nd: oil:	2.3 1.5 3.0	Ø: Length:
		Reference no.:				Reference no.:	Reference no.:	Reference no.:		
						1110B327	ME203533	ME203868		
NM-Motorservice Article no./ Artikelnummer/ Modelo número/ статья номер	NM-Motorservice Article no.:	NM-Motorservice Article no.:		NM-Motorservice Article no.:		NM-Motorservice Article no.:	NM-Motorservice Article no.:	NM-Motorservice Article no.:		
	LBS 25600 PB LBS 25600 SB	LB 25600 P LB 25600 S		KBS 25600 B		KB 25600 B	KR 25600	PB 25600		

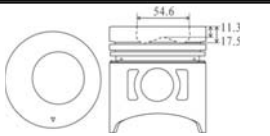

ENGINE TYPE Motortyp/ tipo de motor/ тип двигателя	LINER KIT Liner Kit/ camisas de los cilindros/ Лайнер комплект	CYL. LINER Zylinderlaufbuchse/ camisas de los cilindros/ втулка цилиндра		PISTON + RINGS Kolben + Ringe/ Pistón + Anillos/ поршень и кольца		PISTON SET Kolben Set/ Pistón Set/ поршневой	RINGS SET Ring Set/ Anillos Set/ кольца		PIN Pin/ Perno/ Пин	
4D30			Flanged	No flange	Piston			Rings		
					Length: Outside Ø: Flange Ø: Flange depth:	197.0 104.0 109.0 5.0		197.0 104.0	Length: Comp. height:	
3,298 cc 4 cyl 100.0 mm Bore Ø						Reference no.:				
						ME012001 ME012051 ME012090 ME012100 ME012115 ME012166	Reference no.:	ME012010 ME012070	Reference no.:	ME012203 ME012249 ME012255 ME012257
NM-Motorservice Article no./ Artikelnummer/ Modelo número/ статья номер	NM-Motorservice Article no.:	NM-Motorservice Article no.:	NM-Motorservice Article no.:	NM-Motorservice Article no.:	NM-Motorservice Article no.:	NM-Motorservice Article no.:	NM-Motorservice Article no.:	NM-Motorservice Article no.:	NM-Motorservice Article no.:	NM-Motorservice Article no.:
	LBS 25650 P LBS 25650 S	LB 25650 P LB 25650 S			KBS 25650	KB 25650	KR 25650			PB 25650

ENGINE TYPE Motortyp/ tipo de motor/ тип двигателя	LINER KIT Liner Kit/ camisas de los cilindros/ Лайнер комплект	CYL. LINER Zylinderlaufbuchse/ camisas de los cilindros/ втулка цилиндра		PISTON + RINGS Kolben + Ringe/ Pistón + Anillos/ поршень и кольца		PISTON SET Kolben Set/ Pistón Set/ поршневой	RINGS SET Ring Set/ Anillos Set/ кольца		PIN Pin/ Perno/ Пин	
4D31			Flanged	No flange	Piston			Rings		
					Length: Outside Ø: Flange Ø: Flange depth:	191.0 104.0 109.0 5.0		191.0 104.0	Length: Comp. height:	
3,298 cc 4 cyl 100.0 mm Bore Ø						Reference no.:				
						ME012131 ME012145 ME012160	Reference no.:	ME012010 ME012070	Reference no.:	ME012203 ME012249 ME012255 ME012257
NM-Motorservice Article no./ Artikelnummer/ Modelo número/ статья номер	NM-Motorservice Article no.:	NM-Motorservice Article no.:	NM-Motorservice Article no.:	NM-Motorservice Article no.:	NM-Motorservice Article no.:	NM-Motorservice Article no.:	NM-Motorservice Article no.:	NM-Motorservice Article no.:	NM-Motorservice Article no.:	NM-Motorservice Article no.:
	LBS 25700 P LBS 25700 S	LB 25700 P LB 25700 S			KBS 25700	KB 25700	KR 25700			PB 25700

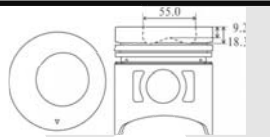
ENGINE TYPE Motortyp/ tipo de motor/ тип двигателя	LINER KIT Liner Kit/ camisas de los cilindros/ Лайнер комплект	CYL. LINER Zylinderlaufbuchse/ camisas de los cilindros/ втулка цилиндра		PISTON + RINGS Kolben + Ringe/ Pistón + Anillos/ поршень и кольца		PISTON SET Kolben Set/ Pistón Set/ поршневой	RINGS SET Ring Set/ Anillos Set/ кольца		PIN Pin/ Perno/ Пин	
4D31T			Flanged	No flange	Piston			Rings		
					Length: Outside Ø: Flange Ø: Flange depth:	191.0 104.0 109.0 5.0		191.0 104.0	Length: Comp. height:	
3,298 cc 4 cyl 100.0 mm Bore Ø						Reference no.:				
						ME011523 ME011604	Reference no.:	ME012010 ME012070	Reference no.:	ME012203 ME012249 ME012255 ME012257
NM-Motorservice Article no./ Artikelnummer/ Modelo número/ статья номер	NM-Motorservice Article no.:	NM-Motorservice Article no.:	NM-Motorservice Article no.:	NM-Motorservice Article no.:	NM-Motorservice Article no.:	NM-Motorservice Article no.:	NM-Motorservice Article no.:	NM-Motorservice Article no.:	NM-Motorservice Article no.:	NM-Motorservice Article no.:
	LBS 25750 PA LBS 25750 SA	LB 25750 P LB 25750 S			KBS 25750 A	KB 25750 A	KR 25750			PB 25750

ENGINE TYPE Motortyp/ tipo de motor/ тип двигателя	LINER KIT Liner Kit/ camisas de los cilindros/ Лайнер комплект	CYL. LINER Zylinderlaufbuchse/ camisas de los cilindros/ втулка цилиндра		PISTON + RINGS Kolben + Ringe/ Pistón + Anillos/ поршень и кольца		PISTON SET Kolben Set/ Pistón Set/ поршневой	RINGS SET Ring Set/ Anillos Set/ кольца		PIN Pin/ Perno/ Пин	
4D31T New			Flanged	No flange	Piston		Rings			
		Length: Outside Ø: Flange Ø: Flange depth:	191.0 104.0 109.0 5.0	191.0 104.0	Length: Comp. height:	110.7 60.7 -11.3 -17.5	Top: 2nd: oil:	3.0 2.0 4.0	Ø: Length:	34.0 84.0
3,298 cc 4 cyl 100.0 mm Bore Ø		Reference no.:				Reference no.:	Reference no.:	Reference no.:		
		ME011523 ME011604				ME012858	ME012848 ME997396 ME997398 ME999783	ME012234		
NM-Motorservice Article no./ Artikelnummer/ Modelo número/ статья номер	NM-Motorservice Article no.:	NM-Motorservice Article no.:		NM-Motorservice Article no.:		NM-Motorservice Article no.:	NM-Motorservice Article no.:	NM-Motorservice Article no.:		
	LBS 25800 PA LBS 25800 SA	LB 25800 P LB 25800 S		KBS 25800 A		KB 25800 A	KR 25800	PB 25800		

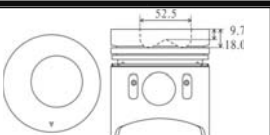
ENGINE TYPE Motortyp/ tipo de motor/ тип двигателя	LINER KIT Liner Kit/ camisas de los cilindros/ Лайнер комплект	CYL. LINER Zylinderlaufbuchse/ camisas de los cilindros/ втулка цилиндра		PISTON + RINGS Kolben + Ringe/ Pistón + Anillos/ поршень и кольца		PISTON SET Kolben Set/ Pistón Set/ поршневой	RINGS SET Ring Set/ Anillos Set/ кольца		PIN Pin/ Perno/ Пин	
4D31T New			Flanged	No flange	Piston		Rings			
		Length: Outside Ø: Flange Ø: Flange depth:	191.0 104.0 109.0 5.0	191.0 104.0	Length: Comp. height:	110.7 60.7 -9.2 -18.3	Top: 2nd: oil:	3.0 2.0 5.0	Ø: Length:	34.0 84.0
3,298 cc 4 cyl 100.0 mm Bore Ø		Reference no.:				Reference no.:	Reference no.:	Reference no.:		
		ME011523 ME011604				ME012155	ME012010 ME012070	ME012234		
NM-Motorservice Article no./ Artikelnummer/ Modelo número/ статья номер	NM-Motorservice Article no.:	NM-Motorservice Article no.:		NM-Motorservice Article no.:		NM-Motorservice Article no.:	NM-Motorservice Article no.:	NM-Motorservice Article no.:		
	LBS 25850 PA LBS 25850 SA	LB 25850 P LB 25850 S		KBS 25850 A		KB 25850 A	KR 25850	PB 25850		

ENGINE TYPE Motortyp/ tipo de motor/ тип двигателя	LINER KIT Liner Kit/ camisas de los cilindros/ Лайнер комплект	CYL. LINER Zylinderlaufbuchse/ camisas de los cilindros/ втулка цилиндра		PISTON + RINGS Kolben + Ringe/ Pistón + Anillos/ поршень и кольца		PISTON SET Kolben Set/ Pistón Set/ поршневой	RINGS SET Ring Set/ Anillos Set/ кольца		PIN Pin/ Perno/ Пин	
4D31			Flanged	No flange	Piston		Rings			
		Length: Outside Ø: Flange Ø: Flange depth:	191.0 104.0 109.0 5.0	191.0 104.0	Length: Comp. height:	110.7 60.7 -9.7 -18.0	Top: 2nd: oil:	3.0 2.0 4.0	Ø: Length:	34.0 84.0
3,298 cc 4 cyl 100.0 mm Bore Ø		Reference no.:				Reference no.:	Reference no.:	Reference no.:		
		ME011523 ME011604				ME012889	ME012848 ME997396 ME997398 ME999783	ME012203 ME012249 ME012255 ME012257		
NM-Motorservice Article no./ Artikelnummer/ Modelo número/ статья номер	NM-Motorservice Article no.:	NM-Motorservice Article no.:		NM-Motorservice Article no.:		NM-Motorservice Article no.:	NM-Motorservice Article no.:	NM-Motorservice Article no.:		
	LBS 25900 P LBS 25900 S	LB 25900 P LB 25900 S		KBS 25900		KB 25900	KR 25900	PB 25900		

ENGINE TYPE Motortyp/ tipo de motor/ тип двигателя	LINER KIT Liner Kit/ camisas de los cilindros/ Лайнер комплект	CYL. LINER Zylinderlaufbuchse/ camisas de los cilindros/ втулка цилиндра		PISTON + RINGS Kolben + Ringe/ Pistón + Anillos/ поршень и кольца		PISTON SET Kolben Set/ Pistón Set/ поршневой	RINGS SET Ring Set/ Anillos Set/ кольца		PIN Pin/ Perno/ Пин	
4D32			Flanged	No flange	Piston		Rings			
		Length: Outside Ø: Flange Ø: Flange depth:	197.0 108.0 113.0 4.0	197.0 108.0	Length: Comp. height:	110.7 60.7 -9.8	Top: 2nd: oil:	3.0 2.0 4.0	Ø: Length:	34.0 84.0
3,567 cc 4 cyl 104.0 mm Bore Ø		Reference no.:				Reference no.:	Reference no.:	Reference no.:		
		ME012900				ME012174	ME997318 ME999243 ME999641	ME012203 ME012249 ME012255 ME012257		
NM-Motorservice Article no./ Artikelnummer/ Modelo número/ статья номер	NM-Motorservice Article no.:	NM-Motorservice Article no.:		NM-Motorservice Article no.:		NM-Motorservice Article no.:	NM-Motorservice Article no.:	NM-Motorservice Article no.:		
	LBS 25950 PA LBS 25950 SA	LB 25950 P LB 25950 S		KBS 25950 A		KB 25950 A	KR 25950	PB 25950		



ENGINE TYPE Motortyp/ tipo de motor/ тип двигателя	LINER KIT Liner Kit/ camisas de los cilindros/ Лайнер комплект	CYL. LINER Zylinderlaufbuchse/ camisas de los cilindros/ втулка цилиндра		PISTON + RINGS Kolben + Ringe/ Pistón + Anillos/ поршень и кольца		PISTON SET Kolben Set/ Pistón Set/ поршневой	RINGS SET Ring Set/ Anillos Set/ кольца		PIN Pin/ Perno/ Пин	
4D34			Flanged	No flange	Piston		Rings			
		Length: Outside Ø: Flange Ø: Flange depth:	200.0 108.0 113.0 4.0	200.0 108.0	Length: Comp. height:	112.2 62.2 -11.5 -20.5	Top: 2nd: oil:	2.8 2.0 4.0	Ø: Length:	34.0 84.0
3,907 cc 4 cyl 104.0 mm Bore Ø		Reference no.:				Reference no.:	Reference no.:	Reference no.:		
		ME013366				ME012901 ME012928	ME996566 ME997240	ME012234		
NM-Motorservice Article no./ Artikelnummer/ Modelo número/ статья номер	NM-Motorservice Article no.:	NM-Motorservice Article no.:		NM-Motorservice Article no.:		NM-Motorservice Article no.:	NM-Motorservice Article no.:	NM-Motorservice Article no.:		
	LBS 40400 PA LBS 40400 SA	LB 40400 P LB 40400 S		KBS 40400 A		KB 40400 A	KR 40400	PB 40400		



ENGINE TYPE Motortyp/ tipo de motor/ тип двигателя	LINER KIT Liner Kit/ camisas de los cilindros/ Лайнер комплект	CYL. LINER Zylinderlaufbuchse/ camisas de los cilindros/ втулка цилиндра		PISTON + RINGS Kolben + Ringe/ Pistón + Anillos/ поршень и кольца		PISTON SET Kolben Set/ Pistón Set/ поршневой	RINGS SET Ring Set/ Anillos Set/ кольца		PIN Pin/ Perno/ Пин	
4D34T			Flanged	No flange	Piston		Rings			
		Length: Outside Ø: Flange Ø: Flange depth:	200.0 108.0 113.0 4.0	200.0 108.0	Length: Comp. height:	112.2 62.2 -5.5 -20.6	Top: 2nd: oil:	2.8 2.0 4.0	Ø: Length:	36.0 88.0
4 cc 3,907 cyl 104.0 mm Bore Ø		Reference no.:				Reference no.:	Reference no.:	Reference no.:		
		ME013366				ME014160	ME996566 ME997240	ME013075		
NM-Motorservice Article no./ Artikelnummer/ Modelo número/ статья номер	NM-Motorservice Article no.:	NM-Motorservice Article no.:		NM-Motorservice Article no.:		NM-Motorservice Article no.:	NM-Motorservice Article no.:	NM-Motorservice Article no.:		
	LBS 26650 PA LBS 26650 SA	LB 26650 P LB 26650 S		KBS 26650 A		KB 26650 A	KR 26650	PB 26650		

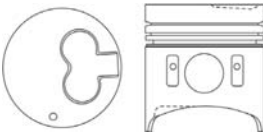

ENGINE TYPE Motortyp/ tipo de motor/ тип двигателя	LINER KIT Liner Kit/ camisas de los cilindros/ Лайнер комплект	CYL. LINER Zylinderlaufbuchse/ camisas de los cilindros/ втулка цилиндра		PISTON + RINGS Kolben + Ringe/ Pistón + Anillos/ поршень и кольца	PISTON SET Kolben Set/ Pistón Set/ поршневой	RINGS SET Ring Set/ Anillos Set/ кольца	PIN Pin/ Perno/ Пин	
4D32 Late 3,567 cc 4 cyl 104.0 mm Bore Ø		Flanged	No flange	Piston		Rings		
		Length: Outside Ø: Flange Ø: Flange depth:	197.0 108.0 113.0 4.0	197.0 108.0	Length: Comp. height:		Top: 2nd: oil:	2.8 2.0 4.0
		Reference no.:			Reference no.:	Reference no.:	Reference no.:	
		ME012900			ME018277	ME996566 ME997240	ME012234	
NM-Motorservice Article no./ Artikelnummer/ Modelo número/ статья номер	NM-Motorservice Article no.:	NM-Motorservice Article no.:		NM-Motorservice Article no.:	NM-Motorservice Article no.:	NM-Motorservice Article no.:	NM-Motorservice Article no.:	
	LBS 26100 PA LBS 26100 SA	LB 26100 P LB 26100 S		KBS 26100 A	KB 26100 A	KR 26100	PB 26100	

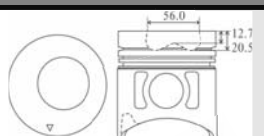

ENGINE TYPE Motortyp/ tipo de motor/ тип двигателя	LINER KIT Liner Kit/ camisas de los cilindros/ Лайнер комплект	CYL. LINER Zylinderlaufbuchse/ camisas de los cilindros/ втулка цилиндра		PISTON + RINGS Kolben + Ringe/ Pistón + Anillos/ поршень и кольца	PISTON SET Kolben Set/ Pistón Set/ поршневой	RINGS SET Ring Set/ Anillos Set/ кольца	PIN Pin/ Perno/ Пин	
4D32 New 3,567 cc 4 cyl 104.0 mm Bore Ø		Flanged	No flange	Piston		Rings		
		Length: Outside Ø: Flange Ø: Flange depth:	197.0 108.0 113.0 4.0	197.0 108.0	Length: Comp. height:	110.7 60.7 -5.6 -18.9	Top: 2nd: oil:	2.8 2.0 4.0
		Reference no.:			Reference no.:	Reference no.:	Reference no.:	
		ME012900			ME018274	ME996566 ME997240	ME012234	
NM-Motorservice Article no./ Artikelnummer/ Modelo número/ статья номер	NM-Motorservice Article no.:	NM-Motorservice Article no.:		NM-Motorservice Article no.:	NM-Motorservice Article no.:	NM-Motorservice Article no.:	NM-Motorservice Article no.:	
	LBS 26150 PA LBS 26150 SA	LB 26150 P LB 26150 S		KBS 26150 A	KB 26150 A	KR 26150	PB 26150	

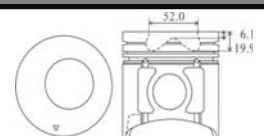

ENGINE TYPE Motortyp/ tipo de motor/ тип двигателя	LINER KIT Liner Kit/ camisas de los cilindros/ Лайнер комплект	CYL. LINER Zylinderlaufbuchse/ camisas de los cilindros/ втулка цилиндра		PISTON + RINGS Kolben + Ringe/ Pistón + Anillos/ поршень и кольца	PISTON SET Kolben Set/ Pistón Set/ поршневой	RINGS SET Ring Set/ Anillos Set/ кольца	PIN Pin/ Perno/ Пин	
4D34T New 3,907 cc 4 cyl 104.0 mm Bore Ø		Flanged	No flange	Piston		Rings		
		Length: Outside Ø: Flange Ø: Flange depth:	200.0 108.0 113.0 4.0	200.0 108.0	Length: Comp. height:	112.2 62.2 -11.5 -22.9	Top: 2nd: oil:	2.8 2.0 4.0
		Reference no.:			Alfin and with oil gallery	Reference no.:	Reference no.:	
		ME013366				ME011143 ME220470	ME996566 ME997240	ME013075
NM-Motorservice Article no./ Artikelnummer/ Modelo número/ статья номер	NM-Motorservice Article no.:	NM-Motorservice Article no.:		NM-Motorservice Article no.:	NM-Motorservice Article no.:	NM-Motorservice Article no.:	NM-Motorservice Article no.:	
	LBS 26200 PB LBS 26200 SB	LB 26200 P LB 26200 S		KBS 26200 B	KB 26200 B	KR 26200	PB 26200	

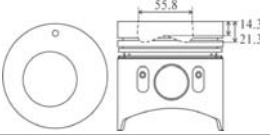

ENGINE TYPE Motortyp/ tipo de motor/ тип двигателя	LINER KIT Liner Kit/ camisas de los cilindros/ Лайнер комплект	CYL. LINER Zylinderlaufbuchse/ camisas de los cilindros/ втулка цилиндра			PISTON + RINGS Kolben + Ringe/ Pistón + Anillos/ поршень и кольца		PISTON SET Kolben Set/ Pistón Set/ поршневой	RINGS SET Ring Set/ Anillos Set/ кольца		PIN Pin/ Perno/ Пин
4D36 3,567 cc 4 cyl 104.0 mm Bore Ø			Flanged	No flange	Piston			Rings		Ø : 34.0 Length: 84.0
		Length: 197.0 Outside Ø: 108.0 Flange Ø: 113.0 Flange depth: 4.0	197.0 108.0		Length: 110.6 Comp. height: 60.5 -2.5 -4.6			Top: 2.8 2nd: 2.0 oil: 4.0		
		Reference no.:					Reference no.:	Reference no.:	Reference no.:	
		ME012900					ME018283	ME996566 ME997240	ME013075	
NM-Motorservice Article no./ Artikelnummer/ Modelo número/ статья номер	NM-Motorservice Article no.:	NM-Motorservice Article no.:			NM-Motorservice Article no.:		NM-Motorservice Article no.:	NM-Motorservice Article no.:	NM-Motorservice Article no.:	NM-Motorservice Article no.:
	LBS 26250 PA LBS 26250 SA	LB 26250 P LB 26250 S			KBS 26250 A		KB 26250 A	KR 26250	PB 26250	

ENGINE TYPE Motortyp/ tipo de motor/ тип двигателя	LINER KIT Liner Kit/ camisas de los cilindros/ Лайнер комплект	CYL. LINER Zylinderlaufbuchse/ camisas de los cilindros/ втулка цилиндра			PISTON + RINGS Kolben + Ringe/ Pistón + Anillos/ поршень и кольца		PISTON SET Kolben Set/ Pistón Set/ поршневой	RINGS SET Ring Set/ Anillos Set/ кольца		PIN Pin/ Perno/ Пин
4D34T 3,907 cc 4 cyl 104.0 mm Bore Ø			Flanged	No flange	Piston			Rings		Ø : 36.0 Length: 88.0
		Length: 200.0 Outside Ø: 108.0 Flange Ø: 113.0 Flange depth: 4.0	200.0 108.0		Length: 112.2 Comp. height: 62.2 -12.7 -20.5			Top: 2.8 2nd: 2.0 oil: 4.0		
		Reference no.:					Reference no.:	Reference no.:	Reference no.:	
		ME013366					ME013325	ME996566 ME997240	ME013075	
NM-Motorservice Article no./ Artikelnummer/ Modelo número/ статья номер	NM-Motorservice Article no.:	NM-Motorservice Article no.:			NM-Motorservice Article no.:		NM-Motorservice Article no.:	NM-Motorservice Article no.:	NM-Motorservice Article no.:	NM-Motorservice Article no.:
	LBS 26300 PA LBS 26300 SA	LB 26300 P LB 26300 S			KBS 26300 A		KB 26300 A	KR 26300	PB 26300	

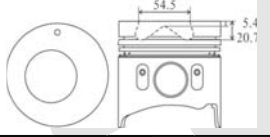
ENGINE TYPE Motortyp/ tipo de motor/ тип двигателя	LINER KIT Liner Kit/ camisas de los cilindros/ Лайнер комплект	CYL. LINER Zylinderlaufbuchse/ camisas de los cilindros/ втулка цилиндра			PISTON + RINGS Kolben + Ringe/ Pistón + Anillos/ поршень и кольца		PISTON SET Kolben Set/ Pistón Set/ поршневой	RINGS SET Ring Set/ Anillos Set/ кольца		PIN Pin/ Perno/ Пин
4D34 • 2AT 4D34 • 3AT 3,907 cc 4 cyl 104.0 mm Bore Ø			Flanged	No flange	Piston		Alfin and with oil gallery	Rings		Ø : 36.0 Length: 88.0
		Length: 200.0 Outside Ø: 108.0 Flange Ø: 113.0 Flange depth: 4.0	200.0 108.0		Length: 112.2 Comp. height: 62.2 -6.1 -19.9			Top: 2.8 2nd: 2.0 oil: 4.0		
		Reference no.:					Reference no.:	Reference no.:	Reference no.:	
		ME013366					ME220454	ME996566 ME997240	ME013075	
NM-Motorservice Article no./ Artikelnummer/ Modelo número/ статья номер	NM-Motorservice Article no.:	NM-Motorservice Article no.:			NM-Motorservice Article no.:		NM-Motorservice Article no.:	NM-Motorservice Article no.:	NM-Motorservice Article no.:	NM-Motorservice Article no.:
	LBS 26350 PB LBS 26350 SB	LB 26350 P LB 26350 S			KBS 26350 B		KB 26350 B	KR 26350	PB 26350	

ENGINE TYPE Motortyp/ tipo de motor/ тип двигателя	LINER KIT Liner Kit/ camisas de los cilindros/ Лайнер комплект	CYL. LINER Zylinderlaufbuchse/ camisas de los cilindros/ втулка цилиндра		PISTON + RINGS Kolben + Ringe/ Pistón + Anillos/ поршень и кольца		PISTON SET Kolben Set/ Pistón Set/ поршневой	RINGS SET Ring Set/ Anillos Set/ кольца		PIN Pin/ Perno/ Пин	
4D33 4,214 cc 4 cyl 108.0 mm Bore Ø			Flanged	No flange	Piston		Rings			
		Length: Outside Ø: Flange Ø: Flange depth:	205.0 112.0 117.0 5.0	200.0 112.0 112.0	Length: Comp. height:	112.2 62.2 -14.3 -21.3	Top: 2nd: oil:	3.0 2.0 4.0	Ø: Length:	34.0 84.0
		Reference no.:				Reference no.:	Reference no.:	Reference no.:		
		ME013333				ME012897 ME013312	ME996378 ME999871	ME012234		
NM-Motorservice Article no./ Artikelnummer/ Modelo número/ статья номер	NM-Motorservice Article no.:	NM-Motorservice Article no.:		NM-Motorservice Article no.:		NM-Motorservice Article no.:	NM-Motorservice Article no.:	NM-Motorservice Article no.:		
	LBS 26400 PA LBS 26400 SA	LB 26400 P LB 26400 S		KBS 26400 A		KB 26400 A	KR 26400	PB 26400		

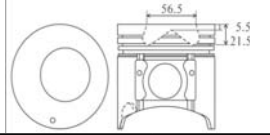

ENGINE TYPE Motortyp/ tipo de motor/ тип двигателя	LINER KIT Liner Kit/ camisas de los cilindros/ Лайнер комплект	CYL. LINER Zylinderlaufbuchse/ camisas de los cilindros/ втулка цилиндра		PISTON + RINGS Kolben + Ringe/ Pistón + Anillos/ поршень и кольца		PISTON SET Kolben Set/ Pistón Set/ поршневой	RINGS SET Ring Set/ Anillos Set/ кольца		PIN Pin/ Perno/ Пин	
4D33 4D33 • 4A 4,214 cc 4 cyl 108.0 mm Bore Ø			Flanged	No flange	Piston		Rings			
		Length: Outside Ø: Flange Ø: Flange depth:	205.0 112.0 117.0 5.0	200.0 112.0 112.0	Length: Comp. height:	112.1 62.2 -5.4 -20.7	Top: 2nd: oil:	3.0 2.0 4.0	Ø: Length:	34.0 83.5
		Reference no.:				Reference no.:	Reference no.:	Reference no.:		
		ME013333				ME018280	ME996378 ME999871	ME012234		
NM-Motorservice Article no./ Artikelnummer/ Modelo número/ статья номер	NM-Motorservice Article no.:	NM-Motorservice Article no.:		NM-Motorservice Article no.:		NM-Motorservice Article no.:	NM-Motorservice Article no.:	NM-Motorservice Article no.:		
	LBS 26450 PA LBS 26450 SA	LB 26450 P LB 26450 S		KBS 26450 A		KB 26450 A	KR 26450	PB 26450		



ENGINE TYPE Motortyp/ tipo de motor/ тип двигателя	LINER KIT Liner Kit/ camisas de los cilindros/ Лайнер комплект	CYL. LINER Zylinderlaufbuchse/ camisas de los cilindros/ втулка цилиндра		PISTON + RINGS Kolben + Ringe/ Pistón + Anillos/ поршень и кольца		PISTON SET Kolben Set/ Pistón Set/ поршневой	RINGS SET Ring Set/ Anillos Set/ кольца		PIN Pin/ Perno/ Пин	
4D35 4D35T 4,561 cc 4 cyl 110.0 mm Bore Ø			Flanged	No flange	Piston		Alfin and with oil gallery		Rings	
		Length: Outside Ø: Flange Ø: Flange depth:	205.0 114.0 119.0 5.0	200.0 114.0 114.0	Length: Comp. height:	109.5 59.8 -5.5 -21.5	Top: 2nd: oil:	3.0 2.5 4.0	Ø: Length:	36.0 88.0
		Reference no.:				Reference no.:	Reference no.:	Reference no.:		
		ME013678				ME018825	ME996628	ME013075		
NM-Motorservice Article no./ Artikelnummer/ Modelo número/ статья номер	NM-Motorservice Article no.:	NM-Motorservice Article no.:		NM-Motorservice Article no.:		NM-Motorservice Article no.:	NM-Motorservice Article no.:	NM-Motorservice Article no.:		
	LBS 45050 PB LBS 45050 SB	LB 45050 P LB 45050 S		KBS 45050 B		KB 45050 B	KR 45050	PB 45050		

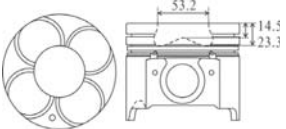

ENGINE TYPE Motor/typo/ tipo de motor/ тип двигателя	LINER KIT Liner Kit/ camisas de los cilindros/ Лайнер комплект	CYL. LINER Zylinderlaufbuchse/ camisas de los cilindros/ втулка цилиндра			PISTON + RINGS Kolben + Ringe/ Pistón + Anillos/ поршень и кольца		PISTON SET Kolben Set/ Pistón Set/ поршневой	RINGS SET Ring Set/ Anillos Set/ кольца		PIN Pin/ Perno/ Пин
4D35 4D35T 4,561 cc 4 cyl 110.0 mm Bore Ø			Flanged	No flange	Piston		Alfin and with oil gallery	Rings		
		Length: Outside Ø: Flange Ø: Flange depth:	205.0 114.0 119.0 5.0	200.0 114.0	Length: Comp. height:	109.6 59.7 -5.5 -21.5		Top: 2nd: oil:	3.0 2.0 4.0	Ø: Length:
		Reference no.:					Reference no.:	Reference no.:	Reference no.:	
		ME013678					ME014693	ME995214	ME013075	
NM-Motorservice Article no./ Artikelnummer/ Modelo número/ статья номер	NM-Motorservice Article no.:	NM-Motorservice Article no.:			NM-Motorservice Article no.:		NM-Motorservice Article no.:	NM-Motorservice Article no.:	NM-Motorservice Article no.:	
	LBS 26550 PB LBS 26550 SB	LB 26550 P LB 26550 S			KBS 26550 B		KB 26550 B	KR 26550	PB 26550	

ENGINE TYPE Motor/typo/ tipo de motor/ тип двигателя	LINER KIT Liner Kit/ camisas de los cilindros/ Лайнер комплект	CYL. LINER Zylinderlaufbuchse/ camisas de los cilindros/ втулка цилиндра			PISTON + RINGS Kolben + Ringe/ Pistón + Anillos/ поршень и кольца		PISTON SET Kolben Set/ Pistón Set/ поршневой	RINGS SET Ring Set/ Anillos Set/ кольца		PIN Pin/ Perno/ Пин
4M50T CANTER FE84D FE85D) 2006-2007 4,899 cc 4 cyl 114.0 mm Bore Ø			Flanged	No flange	Piston		Two alfins and with oil gallery head anodized skirt MOS2 treated	Rings		
		Length: Outside Ø: Flange Ø: Flange depth:			Length: Comp. height:	99.1 59.1 -8.5 -21.0		Top: 2nd: oil:	3.0 2.0 4.0	Ø: Length:
		Reference no.:					Reference no.:	Reference no.:	Reference no.:	
							ME224532 ME224533 ME226782 ME226783	ME993913	ME221709	
NM-Motorservice Article no./ Artikelnummer/ Modelo número/ статья номер	NM-Motorservice Article no.:	NM-Motorservice Article no.:			NM-Motorservice Article no.:		NM-Motorservice Article no.:	NM-Motorservice Article no.:	NM-Motorservice Article no.:	
	LBS 26600 PB LBS 26600 SB	LB 26600 P LB 26600 S			KBS 26600 B		KB 26600 B	KR 26600	PB 26600	

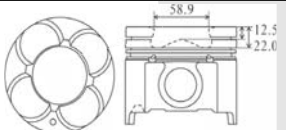
ENGINE TYPE Motor/typo/ tipo de motor/ тип двигателя	LINER KIT Liner Kit/ camisas de los cilindros/ Лайнер комплект	CYL. LINER Zylinderlaufbuchse/ camisas de los cilindros/ втулка цилиндра			PISTON + RINGS Kolben + Ringe/ Pistón + Anillos/ поршень и кольца		PISTON SET Kolben Set/ Pistón Set/ поршневой	RINGS SET Ring Set/ Anillos Set/ кольца		PIN Pin/ Perno/ Пин
4M51 CANTER 5,249 cc 4 cyl 118.0 mm Bore Ø			Flanged	No flange	Piston			Rings		
		Length: Outside Ø: Flange Ø: Flange depth:	190.0 122.0 127.0 5.0	190.0 122.0	Length: Comp. height:			Top: 2nd: oil:	3.0 2.0 4.0	Ø: Length:
		Reference no.:					Reference no.:	Reference no.:	Reference no.:	
							ME995591 ME995592 ME995593		ME012203 ME012249 ME012255 ME012257	
NM-Motorservice Article no./ Artikelnummer/ Modelo número/ статья номер	NM-Motorservice Article no.:	NM-Motorservice Article no.:			NM-Motorservice Article no.:		NM-Motorservice Article no.:	NM-Motorservice Article no.:	NM-Motorservice Article no.:	
	LBS 26650 PA LBS 26650 SA	LB 26650 P LB 26650 S			KBS 26650 A		KB 26650 A	KR 26650	PB 26650	

ENGINE TYPE Motortyp/ tipo de motor/ тип двигателя	LINER KIT Liner Kit/ camisas de los cilindros/ Лайнер комплект	CYL. LINER Zylinderlaufbuchse/ camisas de los cilindros/ втулка цилиндра		PISTON + RINGS Kolben + Ringe/ Pistón + Anillos/ поршень и кольца		PISTON SET Kolben Set/ Pistón Set/ поршневой	RINGS SET Ring Set/ Anillos Set/ кольца		PIN Pin/ Perno/ Пин	
4M51 CANTER 5,249 cc 4 cyl 118.0 mm Bore Ø			Flanged	No flange	Piston		Rings		Ø: Length:	34.0 84.0
		Length: Outside Ø: Flange Ø: Flange depth:	190.0 122.0 127.0 5.0	190.0 122.0	Length: Comp. height:	99.1 59.1 -14.5 -23.3	Top: 2nd: oil:	3.0 2.0 3.0		
		Reference no.:				Reference no.:	Reference no.:	Reference no.:		
						ME240047 ME240316	ME995113 ME995114 ME995115	ME012203 ME012249 ME012255 ME012257		
NM-Motorservice Article no./ Artikelnummer/ Modelo número/ статья номер	NM-Motorservice Article no.:	NM-Motorservice Article no.:		NM-Motorservice Article no.:		NM-Motorservice Article no.:	NM-Motorservice Article no.:	NM-Motorservice Article no.:		
	LBS 26700 PA LBS 26700 SA	LB 26700 P LB 26700 S		KBS 26700 A		KB 26700 A	KR 26700	PB 26700		

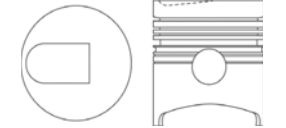

ENGINE TYPE Motortyp/ tipo de motor/ тип двигателя	LINER KIT Liner Kit/ camisas de los cilindros/ Лайнер комплект	CYL. LINER Zylinderlaufbuchse/ camisas de los cilindros/ втулка цилиндра		PISTON + RINGS Kolben + Ringe/ Pistón + Anillos/ поршень и кольца		PISTON SET Kolben Set/ Pistón Set/ поршневой	RINGS SET Ring Set/ Anillos Set/ кольца		PIN Pin/ Perno/ Пин	
4M51T CANTER 5,249 cc 4 cyl 118.0 mm Bore Ø			Flanged	No flange	Piston		Alfin and with oil gallery		Rings	
		Length: Outside Ø: Flange Ø: Flange depth:	190.0 122.0 127.0 5.0	190.0 122.0	Length: Comp. height:	99.1 59.1 -12.5 -22.0	Top: 2nd: oil:	3.0 2.0 4.0	Ø: Length:	34.0 84.0
		Reference no.:				Reference no.:	Reference no.:	Reference no.:		
						ME241686 ME241688	ME995591 ME995592 ME995593	ME012203 ME012249 ME012255 ME012257		
NM-Motorservice Article no./ Artikelnummer/ Modelo número/ статья номер	NM-Motorservice Article no.:	NM-Motorservice Article no.:		NM-Motorservice Article no.:		NM-Motorservice Article no.:	NM-Motorservice Article no.:	NM-Motorservice Article no.:		
	LBS 26750 PB LBS 26750 SB	LB 26750 P LB 26750 S		KBS 26750 B		KB 26750 B	KR 26750	PB 26750		



ENGINE TYPE Motortyp/ tipo de motor/ тип двигателя	LINER KIT Liner Kit/ camisas de los cilindros/ Лайнер комплект	CYL. LINER Zylinderlaufbuchse/ camisas de los cilindros/ втулка цилиндра		PISTON + RINGS Kolben + Ringe/ Pistón + Anillos/ поршень и кольца		PISTON SET Kolben Set/ Pistón Set/ поршневой	RINGS SET Ring Set/ Anillos Set/ кольца		PIN Pin/ Perno/ Пин	
6DR5 3,988 cc 6 cyl 92.0 mm Bore Ø			Liner/ Sleeve		Piston		Rings		Ø: Length:	28.0 77.0
		Length: Outside Ø: Flange Ø: Flange depth:	176.0 95.0		Length: Comp. height:	99.5 52.5 -3.6	Top: 2nd: 3rd: oil:	2.5 2.0 2.0 4.5		
		Reference no.:				Reference no.:	Reference no.:	Reference no.:		
		31607-02202				31617-00106	31717-12012 31717-12013	31619-00700 31619-00792		
NM-Motorservice Article no./ Artikelnummer/ Modelo número/ статья номер	NM-Motorservice Article no.:	NM-Motorservice Article no.:		NM-Motorservice Article no.:		NM-Motorservice Article no.:	NM-Motorservice Article no.:	NM-Motorservice Article no.:		
	LBS 26800 P	LB 26800 P		KBS 26800		KB 26800	KR 26800	PB 26800		

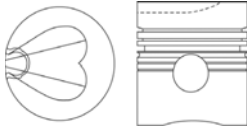

ENGINE TYPE Motortyp/ tipo de motor/ тип двигателя	LINER KIT Liner Kit/ camisas de los cilindros/ Лайнер комплект	CYL. LINER Zylinderlaufbuchse/ camisas de los cilindros/ втулка цилиндра		PISTON + RINGS Kolben + Ringe/ Pistón + Anillos/ поршень и кольца		PISTON SET Kolben Set/ Pistón Set/ поршневой	RINGS SET Ring Set/ Anillos Set/ кольца		PIN Pin/ Perno/ Пин	
6DR5 6DR51 3,988 cc 6 cyl 92.0 mm Bore Ø			Liner/ Sleeve	Piston			Rings		Ø : Length:	28.0 77.0
		Length: Outside Ø: Flange Ø: Flange depth:	176.0 95.0	Length: Comp. height:	99.7 52.7 -2.4		Top: 2nd: 3rd: oil:	2.5 2.0 2.0 4.5		
		Reference no.:				Reference no.:	Reference no.:	Reference no.:		
		31607-02202				MD002044 ME002044	31717-12012 31717-12013	31619-00700 31619-00792		
NM-Motorservice Article no./ Artikelnummer/ Modelo número/ статья номер	NM-Motorservice Article no.:	NM-Motorservice Article no.:		NM-Motorservice Article no.:		NM-Motorservice Article no.:	NM-Motorservice Article no.:	NM-Motorservice Article no.:		
	LBS 26850 P	LB 26850 P		KBS 26850		KB 26850	KR 26850	PB 26850		

ENGINE TYPE Motortyp/ tipo de motor/ тип двигателя	LINER KIT Liner Kit/ camisas de los cilindros/ Лайнер комплект	CYL. LINER Zylinderlaufbuchse/ camisas de los cilindros/ втулка цилиндра		PISTON + RINGS Kolben + Ringe/ Pistón + Anillos/ поршень и кольца		PISTON SET Kolben Set/ Pistón Set/ поршневой	RINGS SET Ring Set/ Anillos Set/ кольца		PIN Pin/ Perno/ Пин	
S6E 3,915 cc 6 cyl 94.0 mm Bore Ø			Liner/ Sleeve	Piston			Rings		Ø : Length:	28.0 77.0
		Length: Outside Ø: Flange Ø: Flange depth:	165.0 98.0	Length: Comp. height:	98.5 51.5 -3.5		Top: 2nd: oil:	2.5 2.0 4.5		
		Reference no.:				Reference no.:	Reference no.:	Reference no.:		
		34407-00301				34417-04101 34417-20101	34417-11011 34417-02012			
NM-Motorservice Article no./ Artikelnummer/ Modelo número/ статья номер	NM-Motorservice Article no.:	NM-Motorservice Article no.:		NM-Motorservice Article no.:		NM-Motorservice Article no.:	NM-Motorservice Article no.:	NM-Motorservice Article no.:		
	LBS 26900 P	LB 26900 P		KBS 26900		KB 26900	KR 26900	PB 26900		

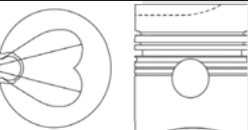

ENGINE TYPE Motortyp/ tipo de motor/ тип двигателя	LINER KIT Liner Kit/ camisas de los cilindros/ Лайнер комплект	CYL. LINER Zylinderlaufbuchse/ camisas de los cilindros/ втулка цилиндра			PISTON + RINGS Kolben + Ringe/ Pistón + Anillos/ поршень и кольца		PISTON SET Kolben Set/ Pistón Set/ поршневой	RINGS SET Ring Set/ Anillos Set/ кольца		PIN Pin/ Perno/ Пин	
S6S 4,996 cc 6 cyl 94.0 mm Bore Ø			Flanged	No flange	Piston			Rings		Ø : Length:	30.0 76.5
		Length: Outside Ø: Flange Ø: Flange depth:	185.0 98.0 101.9 4.0	190.0 98.0	Length: Comp. height:	89.8 55.0 -4.5		Top: 2nd: oil:	2.5 2.0 4.5		
		Reference no.:					Reference no.:	Reference no.:	Reference no.:		
		32A07-00300					32A17-00100	34417-11011 34417-02012			
NM-Motorservice Article no./ Artikelnummer/ Modelo número/ статья номер	NM-Motorservice Article no.:	NM-Motorservice Article no.:			NM-Motorservice Article no.:		NM-Motorservice Article no.:	NM-Motorservice Article no.:	NM-Motorservice Article no.:		
	LBS 26950 P LBS 26950 S	LB 26950 P LB 26950 S			KBS 26950		KB 26950	KR 26950	PB 26950		

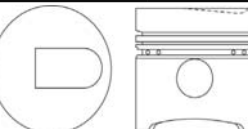

ENGINE TYPE Motortyp/ tipo de motor/ тип двигателя	LINER KIT Liner Kit/ camisas de los cilindros/ Лайнер комплект	CYL. LINER Zylinderlaufbuchse/ camisas de los cilindros/ втулка цилиндра		PISTON + RINGS Kolben + Ringe/ Pistón + Anillos/ поршень и кольца		PISTON SET Kolben Set/ Pistón Set/ поршневой		RINGS SET Ring Set/ Anillos Set/ кольца		PIN Pin/ Perno/ Пин	
6DS7		Liner/ Sleeve		Piston				Rings			
		Length: Outside Ø: Flange Ø: Flange depth:	201.0 110.0 117.0 10.0 +0.9		Length: Comp. height:	105.2 60.73 -9.27		Top: 2nd: oil:	3.0 2.0 5.0	Ø: Length:	32.0 82.0
5,430 cc 6 cyl 98.0 mm Bore Ø		Reference no.:				Reference no.:		Reference no.:		Reference no.:	
		ME021843				ME023274 ME024402		ME021861 ME023333 ME024409		ME020448 ME020449	
NM-Motorservice Article no./ Artikelnummer/ Modelo número/ статья номер	NM-Motorservice Article no.:	NM-Motorservice Article no.:		NM-Motorservice Article no.:		NM-Motorservice Article no.:		NM-Motorservice Article no.:		NM-Motorservice Article no.:	
	LBS 44650 F	LB 44650 F		KBS 44650		KB 44650		KR 44650		PB 44650	

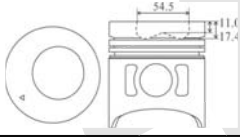

ENGINE TYPE Motortyp/ tipo de motor/ тип двигателя	LINER KIT Liner Kit/ camisas de los cilindros/ Лайнер комплект	CYL. LINER Zylinderlaufbuchse/ camisas de los cilindros/ втулка цилиндра		PISTON + RINGS Kolben + Ringe/ Pistón + Anillos/ поршень и кольца		PISTON SET Kolben Set/ Pistón Set/ поршневой		RINGS SET Ring Set/ Anillos Set/ кольца		PIN Pin/ Perno/ Пин	
6DS7 New		Liner/ Sleeve		Piston				Rings			
		Length: Outside Ø: Flange Ø: Flange depth:	206.0 110.0 117.0 10.0 +1.15		Length: Comp. height:	105.2 60.73 -9.27		Top: 2nd: oil:	3.0 2.0 5.0	Ø: Length:	32.0 82.0
5,430 cc 6 cyl 98.0 mm Bore Ø		Reference no.:				Reference no.:		Reference no.:		Reference no.:	
		ME029081 ME029187				ME023274 ME024402		ME021861 ME023333 ME024409		ME020448 ME020449	
NM-Motorservice Article no./ Artikelnummer/ Modelo número/ статья номер	NM-Motorservice Article no.:	NM-Motorservice Article no.:		NM-Motorservice Article no.:		NM-Motorservice Article no.:		NM-Motorservice Article no.:		NM-Motorservice Article no.:	
	LBS 27050 F	LB 27050 F		KBS 27050		KB 27050		KR 27050		PB 27050	

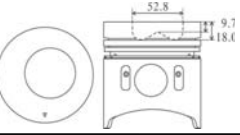

ENGINE TYPE Motortyp/ tipo de motor/ тип двигателя	LINER KIT Liner Kit/ camisas de los cilindros/ Лайнер комплект	CYL. LINER Zylinderlaufbuchse/ camisas de los cilindros/ втулка цилиндра		PISTON + RINGS Kolben + Ringe/ Pistón + Anillos/ поршень и кольца		PISTON SET Kolben Set/ Pistón Set/ поршневой		RINGS SET Ring Set/ Anillos Set/ кольца		PIN Pin/ Perno/ Пин	
S6E2		Liner/ Sleeve		Piston				Rings			
		Length: Outside Ø: Flange Ø: Flange depth:	168.5 102.0 102.0 10.0 -3.2		Length: Comp. height:	98.5 51.5 -3.2		Top: 2nd: oil:	3.0 2.0 3.0	Ø: Length:	28.0 77.0
4,440 cc 6 cyl 98.0 mm Bore Ø		Reference no.:				Reference no.:		Reference no.:		Reference no.:	
		34407-05400				34417-54100		34417-09012			
NM-Motorservice Article no./ Artikelnummer/ Modelo número/ статья номер	NM-Motorservice Article no.:	NM-Motorservice Article no.:		NM-Motorservice Article no.:		NM-Motorservice Article no.:		NM-Motorservice Article no.:		NM-Motorservice Article no.:	
	LBS 27100 P	LB 27100 P		KBS 27100		KB 27100		KR 27100		PB 27100	

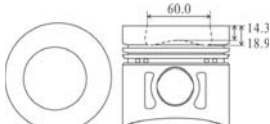

ENGINE TYPE Motortyp/ tipo de motor/ тип двигателя	LINER KIT Liner Kit/ camisas de los cilindros/ Лайнер комплект	CYL. LINER Zylinderlaufbuchse/ camisas de los cilindros/ втулка цилиндра		PISTON + RINGS Kolben + Ringe/ Pistón + Anillos/ поршень и кольца		PISTON SET Kolben Set/ Pistón Set/ поршневой		RINGS SET Ring Set/ Anillos Set/ кольца		PIN Pin/ Perno/ Пин	
S6F			Liner/ Sleeve	Piston				Rings			
		Length: Outside Ø: Flange Ø: Flange depth:	168.5 102.0		Length: Comp. height:	96.5 57.6 -14.5 -18.2		Top: 2nd: oil:	3.0 2.0 3.0	Ø: Length:	32.0 78.0
4,432 cc 6 cyl 98.0 mm Bore Ø		Reference no.:				Reference no.:		Reference no.:		Reference no.:	
		34407-05400						34417-09012			
NM-Motorservice Article no./ Artikelnummer/ Modelo número/ статья номер	NM-Motorservice Article no.:	NM-Motorservice Article no.:		NM-Motorservice Article no.:		NM-Motorservice Article no.:		NM-Motorservice Article no.:		NM-Motorservice Article no.:	
	LBS 27150 P LBS 27150 PA	LB 27150 P		KBS 27150 KBS 27150 A		KB 27150 KB 27150 A		KR 27150		PB 27150	

ENGINE TYPE Motortyp/ tipo de motor/ тип двигателя	LINER KIT Liner Kit/ camisas de los cilindros/ Лайнер комплект	CYL. LINER Zylinderlaufbuchse/ camisas de los cilindros/ втулка цилиндра			PISTON + RINGS Kolben + Ringe/ Pistón + Anillos/ поршень и кольца		PISTON SET Kolben Set/ Pistón Set/ поршневой		RINGS SET Ring Set/ Anillos Set/ кольца		PIN Pin/ Perno/ Пин	
6D31T			Flange	No flange	Piston				Rings			
		Length: Outside Ø: Flange Ø: Flange depth:	191.0 104.0 109.0 5.0	191.0 104.0	Length: Comp. height:	110.7 60.7 -11.0 -17.4		Top: 2nd: oil:	3.0 2.0 4.0	Ø: Length:	34.0 84.0	
4,948 cc 6 cyl 100.0 mm Bore Ø		Reference no.:					Reference no.:		Reference no.:		Reference no.:	
		ME011626					ME012858		ME997458 ME999836		ME012257	
NM-Motorservice Article no./ Artikelnummer/ Modelo número/ статья номер	NM-Motorservice Article no.:	NM-Motorservice Article no.:			NM-Motorservice Article no.:		NM-Motorservice Article no.:		NM-Motorservice Article no.:		NM-Motorservice Article no.:	
	LBS 27200 PA LBS 27200 SA	LB 27200 P LB 27200 S			KBS 27200 A		KB 27200 A		KR 27200		PB 27200	

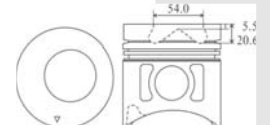
ENGINE TYPE Motortyp/ tipo de motor/ тип двигателя	LINER KIT Liner Kit/ camisas de los cilindros/ Лайнер комплект	CYL. LINER Zylinderlaufbuchse/ camisas de los cilindros/ втулка цилиндра			PISTON + RINGS Kolben + Ringe/ Pistón + Anillos/ поршень и кольца		PISTON SET Kolben Set/ Pistón Set/ поршневой		RINGS SET Ring Set/ Anillos Set/ кольца		PIN Pin/ Perno/ Пин	
6D31			Flange	No flange	Piston				Rings			
		Length: Outside Ø: Flange Ø: Flange depth:	191.0 104.0 109.0 5.0	191.0 104.0	Length: Comp. height:	110.7 60.7 -9.7 -18.0		Top: 2nd: oil:	3.0 2.0 5.0	Ø: Length:	34.0 84.0	
4,948 cc 6 cyl 100.0 mm Bore Ø		Reference no.:					Reference no.:		Reference no.:		Reference no.:	
		ME011626							ME999717		ME012257	
NM-Motorservice Article no./ Artikelnummer/ Modelo número/ статья номер	NM-Motorservice Article no.:	NM-Motorservice Article no.:			NM-Motorservice Article no.:		NM-Motorservice Article no.:		NM-Motorservice Article no.:		NM-Motorservice Article no.:	
	LBS 27250 P LBS 27250	LB 27250 P LB 27250 S			KBS 27250		KB 27250		KR 27250		PB 27250	

ENGINE TYPE Motortyp/ tipo de motor/ тип двигателя	LINER KIT Liner Kit/ camisas de los cilindros/ Лайнер комплект	CYL. LINER Zylinderlaufbuchse/ camisas de los cilindros/ втулка цилиндра		PISTON + RINGS Kolben + Ringe/ Pistón + Anillos/ поршень и кольца	PISTON SET Kolben Set/ Pistón Set/ поршневой	RINGS SET Ring Set/ Anillos Set/ кольца	PIN Pin/ Perno/ Пин	
S6KT 6,380 cc 6 cyl 102.0 mm Bore Ø		Liner/ Sleeve		Piston		Rings		
		Length: Outside Ø: Flange Ø: Flange depth:	196.0 105.0		Length: Comp. height:	97.8 57.8 -14.3 -18.9	Top: 2nd: oil:	3.0 2.0 4.0
		Reference no.:				Reference no.:	Reference no.:	Reference no.:
		34307-00500 34307-00501				34317-10200 975-10200	34317-19010	34319-10500
NM-Motorservice Article no./ Artikelnummer/ Modelo número/ статья номер	NM-Motorservice Article no.:	NM-Motorservice Article no.:		NM-Motorservice Article no.:		NM-Motorservice Article no.:	NM-Motorservice Article no.:	NM-Motorservice Article no.:
	LBS 27300 PA	LB 27300 P		KBS 27300 A		KB 27300 A	KR 27300	PB 27300

ENGINE TYPE Motortyp/ tipo de motor/ тип двигателя	LINER KIT Liner Kit/ camisas de los cilindros/ Лайнер комплект	CYL. LINER Zylinderlaufbuchse/ camisas de los cilindros/ втулка цилиндра		PISTON + RINGS Kolben + Ringe/ Pistón + Anillos/ поршень и кольца	PISTON SET Kolben Set/ Pistón Set/ поршневой	RINGS SET Ring Set/ Anillos Set/ кольца	PIN Pin/ Perno/ Пин	
6D34T 5,861 cc 6 cyl 104.0 mm Bore Ø		Flanged	No flange	Piston		Rings		
		Length: Outside Ø: Flange Ø: Flange depth:	200.0 108.0 113.0 4.0	200.0 108.0	Length: Comp. height:	112.2 62.2 -5.5 -20.6	Top: 2nd: oil:	2.8 2.0 4.0
		Reference no.:				Reference no.:	Reference no.:	Reference no.:
		ME012900 ME013366				ME014160	ME996442	
NM-Motorservice Article no./ Artikelnummer/ Modelo número/ статья номер	NM-Motorservice Article no.:	NM-Motorservice Article no.:		NM-Motorservice Article no.:		NM-Motorservice Article no.:	NM-Motorservice Article no.:	NM-Motorservice Article no.:
	LBS 27350 PA LBS 27350 SA	LB 27350 P LB 27350 S		KBS 27350 A		KB 27350 A	KR 27350	PB 27350

ENGINE TYPE Motortyp/ tipo de motor/ тип двигателя	LINER KIT Liner Kit/ camisas de los cilindros/ Лайнер комплект	CYL. LINER Zylinderlaufbuchse/ camisas de los cilindros/ втулка цилиндра		PISTON + RINGS Kolben + Ringe/ Pistón + Anillos/ поршень и кольца	PISTON SET Kolben Set/ Pistón Set/ поршневой	RINGS SET Ring Set/ Anillos Set/ кольца	PIN Pin/ Perno/ Пин	
6D34 • 2AT 6D34 • 3AT 5,861 cc 6 cyl 104.0 mm Bore Ø		Flanged	No flange	Piston		Rings		
		Length: Outside Ø: Flange Ø: Flange depth:	200.0 108.0 113.0 4.0	200.0 108.0	Length: Comp. height:	112.2 62.2 -6.1 -19.9	Top: 2nd: oil:	2.8 2.0 4.0
		Reference no.:				Reference no.:	Reference no.:	Reference no.:
		ME012900 ME013366				ME220454	ME996442	
NM-Motorservice Article no./ Artikelnummer/ Modelo número/ статья номер	NM-Motorservice Article no.:	NM-Motorservice Article no.:		NM-Motorservice Article no.:		NM-Motorservice Article no.:	NM-Motorservice Article no.:	NM-Motorservice Article no.:
	LBS 27400 PB LBS 27400 SB	LB 27400 P LB 27400 S		KBS 27400 B		KB 27400 B	KR 27400	PB 27400

ENGINE TYPE Motortyp/ tipo de motor/ тип двигателя	LINER KIT Liner Kit/ camisas de los cilindros/ Лайнер комплект	CYL. LINER Zylinderlaufbuchse/ camisas de los cilindros/ втулка цилиндра	PISTON + RINGS Kolben + Ringe/ Pistón + Anillos/ поршень и кольца	PISTON SET Kolben Set/ Pistón Set/ поршневой	RINGS SET Ring Set/ Anillos Set/ кольца	PIN Pin/ Perno/ Пин	
6D10 5,974 cc 6 cyl 105.0 mm Bore Ø		Liner/ Sleeve	Piston		Rings		
		Length: Outside Ø: Flange Ø: Flange depth:	205.8 119.0 126.0 10.0 +1.3	Length: Comp. height:	130.7 71.0 -8.0 -10.0	Top: 2nd: oil:	3.0 2.0 5.0
		Reference no.:	Reference no.:	Reference no.:	Reference no.:	Reference no.:	
		ME031502	O-Ring: ME031604	ME032194 ME032300	ME032190 ME032326	ME032014 ME032015 ME033943	
NM-Motorservice Article no./ Artikelnummer/ Modelo número/ статья номер	NM-Motorservice Article no.:	NM-Motorservice Article no.:	NM-Motorservice Article no.:	NM-Motorservice Article no.:	NM-Motorservice Article no.:	NM-Motorservice Article no.:	
	LBS 27450 F	LB 27450 F	KBS 27450	KB 27450	KR 27450	PB 27450	

ENGINE TYPE Motortyp/ tipo de motor/ тип двигателя	LINER KIT Liner Kit/ camisas de los cilindros/ Лайнер комплект	CYL. LINER Zylinderlaufbuchse/ camisas de los cilindros/ втулка цилиндра	PISTON + RINGS Kolben + Ringe/ Pistón + Anillos/ поршень и кольца	PISTON SET Kolben Set/ Pistón Set/ поршневой	RINGS SET Ring Set/ Anillos Set/ кольца	PIN Pin/ Perno/ Пин	
6D11 6,754 cc 6 cyl 105.0 mm Bore Ø		Liner/ Sleeve	Piston		Rings		
		Length: Outside Ø: Flange Ø: Flange depth:	228.3 119.0 126.0 10.0 +1.3	Length: Comp. height:	130.7 71.0 -8.0 -10.0	Top: 2nd: oil:	3.0 2.0 5.0
		Reference no.:	Reference no.:	Reference no.:	Reference no.:	Reference no.:	
		ME031505	O-Ring: ME031604	ME032301	ME032190 ME032326		
NM-Motorservice Article no./ Artikelnummer/ Modelo número/ статья номер	NM-Motorservice Article no.:	NM-Motorservice Article no.:	NM-Motorservice Article no.:	NM-Motorservice Article no.:	NM-Motorservice Article no.:	NM-Motorservice Article no.:	
	LBS 45100 F	LB 45100 F	KBS 45100	KB 45100	KR 45100	PB 45100	

ENGINE TYPE Motortyp/ tipo de motor/ тип двигателя	LINER KIT Liner Kit/ camisas de los cilindros/ Лайнер комплект	CYL. LINER Zylinderlaufbuchse/ camisas de los cilindros/ втулка цилиндра	PISTON + RINGS Kolben + Ringe/ Pistón + Anillos/ поршень и кольца	PISTON SET Kolben Set/ Pistón Set/ поршневой	RINGS SET Ring Set/ Anillos Set/ кольца	PIN Pin/ Perno/ Пин	
6D14 6,557 cc 6 cyl 110.0 mm Bore Ø		Liner/ Sleeve	Piston		Rings		
		Length: Outside Ø: Flange Ø: Flange depth:	206.0 122.0 130.6 10.0 +1.4	Length: Comp. height:	115.9 70.9 -11.3 -20.7	Top: 2nd: oil:	3.0 2.5 5.0
		Reference no.:	Reference no.:	Reference no.:	Reference no.:	Reference no.:	
		ME031453 ME071174 ME031463 ME071198 ME031508 ME031617 ME031510 ME031618	O-Ring: ME031605	ME032216 ME032298 ME032531 ME032619 ME032621	ME032071 ME032260 ME032404 ME032458 ME033904 ME997423 ME997439		ME032014 ME032015 ME033943
NM-Motorservice Article no./ Artikelnummer/ Modelo número/ статья номер	NM-Motorservice Article no.:	NM-Motorservice Article no.:	NM-Motorservice Article no.:	NM-Motorservice Article no.:	NM-Motorservice Article no.:	NM-Motorservice Article no.:	
	LBS 27550 F	LB 27550 F	KBS 27550	KB 27550	KR 27550	PB 27550	

ENGINE TYPE Motortyp/ tipo de motor/ тип двигателя	LINER KIT Liner Kit/ camisas de los cilindros/ Лайнер комплект	CYL. LINER Zylinderlaufbuchse/ camisas de los cilindros/ втулка цилиндра	PISTON + RINGS Kolben + Ringe/ Pistón + Anillos/ поршень и кольца	PISTON SET Kolben Set/ Pistón Set/ поршневой	RINGS SET Ring Set/ Anillos Set/ кольца	PIN Pin/ Perno/ Пин																																		
6D14 • A		<table border="1"> <tr> <td></td> <td>Liner/ Sleeve</td> <td></td> </tr> <tr> <td>Length:</td> <td>206.0</td> <td></td> </tr> <tr> <td>Outside Ø:</td> <td>122.0</td> <td></td> </tr> <tr> <td>Flange Ø:</td> <td>130.6</td> <td></td> </tr> <tr> <td>Flange depth:</td> <td>10.0 +1.4</td> <td></td> </tr> </table>		Liner/ Sleeve		Length:	206.0		Outside Ø:	122.0		Flange Ø:	130.6		Flange depth:	10.0 +1.4		<table border="1"> <tr> <td></td> <td>Piston</td> <td></td> </tr> <tr> <td>Length:</td> <td>116.1</td> <td></td> </tr> <tr> <td>Comp. height:</td> <td>71.1 -12.0 -21.0</td> <td></td> </tr> </table>		Piston		Length:	116.1		Comp. height:	71.1 -12.0 -21.0			<table border="1"> <tr> <td></td> <td>Rings</td> <td></td> </tr> <tr> <td>Top:</td> <td>3.0</td> <td rowspan="3">Ø : 38.0 Length: 90.0</td> </tr> <tr> <td>2nd: oil:</td> <td>2.5 5.0</td> </tr> <tr> <td colspan="2">Reference no.:</td> </tr> </table>		Rings		Top:	3.0	Ø : 38.0 Length: 90.0	2nd: oil:	2.5 5.0	Reference no.:		
				Liner/ Sleeve																																				
Length:	206.0																																							
Outside Ø:	122.0																																							
Flange Ø:	130.6																																							
Flange depth:	10.0 +1.4																																							
	Piston																																							
Length:	116.1																																							
Comp. height:	71.1 -12.0 -21.0																																							
	Rings																																							
Top:	3.0	Ø : 38.0 Length: 90.0																																						
2nd: oil:	2.5 5.0																																							
Reference no.:																																								
6,557 cc 6 cyl 110.0 mm Bore Ø																																								
NM-Motorservice Article no./ Artikelnummer/ Modelo número/ статья номер	NM-Motorservice Article no.:	NM-Motorservice Article no.:	NM-Motorservice Article no.:	NM-Motorservice Article no.:	NM-Motorservice Article no.:	NM-Motorservice Article no.:																																		
	LBS 27600 F	LB 27600 F	KBS 27600	KB 27600	KR 27600	PB 27600																																		

ENGINE TYPE Motortyp/ tipo de motor/ тип двигателя	LINER KIT Liner Kit/ camisas de los cilindros/ Лайнер комплект	CYL. LINER Zylinderlaufbuchse/ camisas de los cilindros/ втулка цилиндра	PISTON + RINGS Kolben + Ringe/ Pistón + Anillos/ поршень и кольца	PISTON SET Kolben Set/ Pistón Set/ поршневой	RINGS SET Ring Set/ Anillos Set/ кольца	PIN Pin/ Perno/ Пин																																		
6D14 • 2A		<table border="1"> <tr> <td></td> <td>Liner/ Sleeve</td> <td></td> </tr> <tr> <td>Length:</td> <td>206.0</td> <td></td> </tr> <tr> <td>Outside Ø:</td> <td>122.0</td> <td></td> </tr> <tr> <td>Flange Ø:</td> <td>130.6</td> <td></td> </tr> <tr> <td>Flange depth:</td> <td>10.0 +1.4</td> <td></td> </tr> </table>		Liner/ Sleeve		Length:	206.0		Outside Ø:	122.0		Flange Ø:	130.6		Flange depth:	10.0 +1.4		<table border="1"> <tr> <td></td> <td>Piston</td> <td></td> </tr> <tr> <td>Length:</td> <td>115.8</td> <td></td> </tr> <tr> <td>Comp. height:</td> <td>70.8 -11.5 -20.8</td> <td></td> </tr> </table>		Piston		Length:	115.8		Comp. height:	70.8 -11.5 -20.8			<table border="1"> <tr> <td></td> <td>Rings</td> <td></td> </tr> <tr> <td>Top:</td> <td>3.0</td> <td rowspan="3">Ø : 38.0 Length: 90.0</td> </tr> <tr> <td>2nd: oil:</td> <td>2.5 5.0</td> </tr> <tr> <td colspan="2">Reference no.:</td> </tr> </table>		Rings		Top:	3.0	Ø : 38.0 Length: 90.0	2nd: oil:	2.5 5.0	Reference no.:		
				Liner/ Sleeve																																				
Length:	206.0																																							
Outside Ø:	122.0																																							
Flange Ø:	130.6																																							
Flange depth:	10.0 +1.4																																							
	Piston																																							
Length:	115.8																																							
Comp. height:	70.8 -11.5 -20.8																																							
	Rings																																							
Top:	3.0	Ø : 38.0 Length: 90.0																																						
2nd: oil:	2.5 5.0																																							
Reference no.:																																								
6,557 cc 6 cyl 110.0 mm Bore Ø																																								
NM-Motorservice Article no./ Artikelnummer/ Modelo número/ статья номер	NM-Motorservice Article no.:	NM-Motorservice Article no.:	NM-Motorservice Article no.:	NM-Motorservice Article no.:	NM-Motorservice Article no.:	NM-Motorservice Article no.:																																		
	LBS 27650 FA	LB 27650 F	KBS 27650 A	KB 27650 A	KR 27650	PB 27650																																		

ENGINE TYPE Motortyp/ tipo de motor/ тип двигателя	LINER KIT Liner Kit/ camisas de los cilindros/ Лайнер комплект	CYL. LINER Zylinderlaufbuchse/ camisas de los cilindros/ втулка цилиндра	PISTON + RINGS Kolben + Ringe/ Pistón + Anillos/ поршень и кольца	PISTON SET Kolben Set/ Pistón Set/ поршневой	RINGS SET Ring Set/ Anillos Set/ кольца	PIN Pin/ Perno/ Пин																																		
6D14T		<table border="1"> <tr> <td></td> <td>Liner/ Sleeve</td> <td></td> </tr> <tr> <td>Length:</td> <td>206.0</td> <td></td> </tr> <tr> <td>Outside Ø:</td> <td>122.0</td> <td></td> </tr> <tr> <td>Flange Ø:</td> <td>130.6</td> <td></td> </tr> <tr> <td>Flange depth:</td> <td>10.0 +1.4</td> <td></td> </tr> </table>		Liner/ Sleeve		Length:	206.0		Outside Ø:	122.0		Flange Ø:	130.6		Flange depth:	10.0 +1.4		<table border="1"> <tr> <td></td> <td>Piston</td> <td></td> </tr> <tr> <td>Length:</td> <td>116.1</td> <td></td> </tr> <tr> <td>Comp. height:</td> <td>71.1 -10.0 -20.0</td> <td></td> </tr> </table>		Piston		Length:	116.1		Comp. height:	71.1 -10.0 -20.0			<table border="1"> <tr> <td></td> <td>Rings</td> <td></td> </tr> <tr> <td>Top:</td> <td>3.0</td> <td rowspan="3">Ø : 38.0 Length: 90.0</td> </tr> <tr> <td>2nd: oil:</td> <td>2.5 5.0</td> </tr> <tr> <td colspan="2">Reference no.:</td> </tr> </table>		Rings		Top:	3.0	Ø : 38.0 Length: 90.0	2nd: oil:	2.5 5.0	Reference no.:		
				Liner/ Sleeve																																				
Length:	206.0																																							
Outside Ø:	122.0																																							
Flange Ø:	130.6																																							
Flange depth:	10.0 +1.4																																							
	Piston																																							
Length:	116.1																																							
Comp. height:	71.1 -10.0 -20.0																																							
	Rings																																							
Top:	3.0	Ø : 38.0 Length: 90.0																																						
2nd: oil:	2.5 5.0																																							
Reference no.:																																								
6,557 cc 6 cyl 110.0 mm Bore Ø																																								
NM-Motorservice Article no./ Artikelnummer/ Modelo número/ статья номер	NM-Motorservice Article no.:	NM-Motorservice Article no.:	NM-Motorservice Article no.:	NM-Motorservice Article no.:	NM-Motorservice Article no.:	NM-Motorservice Article no.:																																		
	LBS 27700 FA	LB 27700 F	KBS 27700 A	KB 27700 A	KR 27700	PB 27700																																		

ENGINE TYPE Motortyp/ tipo de motor/ тип двигателя	LINER KIT Liner Kit/ camisas de los cilindros/ Лайнер комплект	CYL. LINER Zylinderlaufbuchse/ camisas de los cilindros/ втулка цилиндра	PISTON + RINGS Kolben + Ringe/ Pistón + Anillos/ поршень и кольца	PISTON SET Kolben Set/ Pistón Set/ поршневой	RINGS SET Ring Set/ Anillos Set/ кольца	PIN Pin/ Perno/ Пин	
6D14T 6,557 cc 6 cyl 110.0 mm Bore Ø		Liner/ Sleeve	Piston		Rings		
		Length: Outside Ø: Flange Ø: Flange depth:	206.0 122.0 130.6 10.0 +1.4	Length: Comp. height:	116.1 71.2 -10.2 -20.3	Top: 2nd: oil:	3.0 2.5 5.0
		Reference no.:	Reference no.:	Reference no.:	Reference no.:	Reference no.:	
		ME031453 ME071174 ME031463 ME071198 ME031508 ME031617 ME031510 ME031618	O-Ring: ME031605	ME032742	ME032071 ME032260 ME032404 ME032458 ME033904 ME997423 ME997439	ME032014 ME032015 ME033943	
NM-Motorservice Article no./ Artikelnummer/ Modelo número/ статья номер	NM-Motorservice Article no.:	NM-Motorservice Article no.:	NM-Motorservice Article no.:	NM-Motorservice Article no.:	NM-Motorservice Article no.:	NM-Motorservice Article no.:	
	LBS 27750 FA	LB 27750 F	KBS 27750 A	KB 27750 A	KR 27750	PB 27750	



ENGINE TYPE Motortyp/ tipo de motor/ тип двигателя	LINER KIT Liner Kit/ camisas de los cilindros/ Лайнер комплект	CYL. LINER Zylinderlaufbuchse/ camisas de los cilindros/ втулка цилиндра	PISTON + RINGS Kolben + Ringe/ Pistón + Anillos/ поршень и кольца	PISTON SET Kolben Set/ Pistón Set/ поршневой	RINGS SET Ring Set/ Anillos Set/ кольца	PIN Pin/ Perno/ Пин	
6D14 • 2A 6D14 • 3A 6,557 cc 6 cyl 110.0 mm Bore Ø		Liner/ Sleeve	Piston		Rings		
		Length: Outside Ø: Flange Ø: Flange depth:	206.0 122.0 130.6 10.0 +1.4	Length: Comp. height:	116.1 71.1 -12.1 -20.6	Top: 2nd: oil:	3.0 2.5 4.0
		Reference no.:	Reference no.:	Reference no.:	Reference no.:	Reference no.:	
		ME031453 ME071174 ME031463 ME071198 ME031508 ME031618 ME031510 ME031617	O-Ring: ME031605	ME072064 ME072170 ME072172	ME999952 ME999927	ME072128	
NM-Motorservice Article no./ Artikelnummer/ Modelo número/ статья номер	NM-Motorservice Article no.:	NM-Motorservice Article no.:	NM-Motorservice Article no.:	NM-Motorservice Article no.:	NM-Motorservice Article no.:	NM-Motorservice Article no.:	
	LBS 27800 FA	LB 27800 F	KBS 27800 A	KB 27800 A	KR 27800	PB 27800	



ENGINE TYPE Motortyp/ tipo de motor/ тип двигателя	LINER KIT Liner Kit/ camisas de los cilindros/ Лайнер комплект	CYL. LINER Zylinderlaufbuchse/ camisas de los cilindros/ втулка цилиндра	PISTON + RINGS Kolben + Ringe/ Pistón + Anillos/ поршень и кольца	PISTON SET Kolben Set/ Pistón Set/ поршневой	RINGS SET Ring Set/ Anillos Set/ кольца	PIN Pin/ Perno/ Пин	
6D14 • 3AT 6,557 cc 6 cyl 110.0 mm Bore Ø		Liner/ Sleeve	Piston		Rings		
		Length: Outside Ø: Flange Ø: Flange depth:	210.0 121.95 130.65 10.0 +1.4	Length: Comp. height:	116.1 71.1 -12.3 -21.5	Top: 2nd: oil:	2.8 2.5 4.0
		Reference no.:	Reference no.:	Reference no.:	Reference no.:	Reference no.:	
		ME071175 ME071199	O-Ring: ME031605	ME072047	ME997465	ME072128	
NM-Motorservice Article no./ Artikelnummer/ Modelo número/ статья номер	NM-Motorservice Article no.:	NM-Motorservice Article no.:	NM-Motorservice Article no.:	NM-Motorservice Article no.:	NM-Motorservice Article no.:	NM-Motorservice Article no.:	
	LBS 27850 FA	LB 27850 F	KBS 27850 A	KB 27850 A	KR 27850	PB 27850	

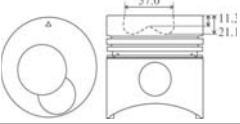

ENGINE TYPE Motortyp/ tipo de motor/ тип двигателя	LINER KIT Liner Kit/ camisas de los cilindros/ Лайнер комплект	CYL. LINER Zylinderlaufbuchse/ camisas de los cilindros/ втулка цилиндра		PISTON + RINGS Kolben + Ringe/ Pistón + Anillos/ поршень и кольца		PISTON SET Kolben Set/ Pistón Set/ поршневой	RINGS SET Ring Set/ Anillos Set/ кольца		PIN Pin/ Perno/ Пин	
6DB1		Liner/ Sleeve		Piston			Rings		Ø: Length:	40.0 95.0
		Length: Outside Ø: Flange Ø: Flange depth:	270.0 125.9 134.5 11.82	Length: Comp. height:	152.5 77.5 -2.6		Top: 2nd: 3rd: oil:	3.5 2.5 2.5 5.0		
8,550 cc 6 cyl 110.0 mm Bore Ø		Reference no.:				Reference no.:	Reference no.:	Reference no.:		
		30007-62200 ME040040				30017-82101 30017-90100 30017-93101	30017-71002 30017-71003 30017-73002 30017-75002 30017-75003	30019-20601		
NM-Motorservice Article no./ Artikelnummer/ Modelo número/ статья номер	NM-Motorservice Article no.:	NM-Motorservice Article no.:		NM-Motorservice Article no.:		NM-Motorservice Article no.:	NM-Motorservice Article no.:	NM-Motorservice Article no.:		
	LBS 27900 F LBS 27900 FA	LB 27900 F		KBS 27900 KBS 27900 A		KB 27900 KB 27900 A	KR 27900	PB 27900		

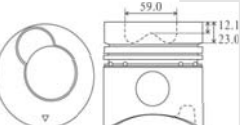

ENGINE TYPE Motortyp/ tipo de motor/ тип двигателя	LINER KIT Liner Kit/ camisas de los cilindros/ Лайнер комплект	CYL. LINER Zylinderlaufbuchse/ camisas de los cilindros/ втулка цилиндра		PISTON + RINGS Kolben + Ringe/ Pistón + Anillos/ поршень и кольца		PISTON SET Kolben Set/ Pistón Set/ поршневой	RINGS SET Ring Set/ Anillos Set/ кольца		PIN Pin/ Perno/ Пин	
6D14 • A		Liner/ Sleeve		Piston			Rings		Ø: Length:	38.0 90.0
		Length: Outside Ø: Flange Ø: Flange depth:	206.0 122.0 130.6 10.0 +1.4	Length: Comp. height:	115.8 70.8 -11.9 -21.0		Top: 2nd: oil:	3.0 2.5 5.0		
6,557 cc 6 cyl 110.0 mm Bore Ø		Reference no.:		Reference no.:		Reference no.:	Reference no.:		Reference no.:	
		ME031453 ME071174 ME031463 ME071198 ME031508 ME031618 ME031510 ME031617		O-Ring: ME031605		ME032626	ME032071 ME032260 ME032404 ME032458 ME033904 ME997423 ME997439	ME032014 ME032015 ME033943		
NM-Motorservice Article no./ Artikelnummer/ Modelo número/ статья номер	NM-Motorservice Article no.:	NM-Motorservice Article no.:		NM-Motorservice Article no.:		NM-Motorservice Article no.:	NM-Motorservice Article no.:	NM-Motorservice Article no.:		
	LBS 27950 F	LB 27950 F		KBS 27950		KB 27950	KR 27950	PB 27950		



ENGINE TYPE Motortyp/ tipo de motor/ тип двигателя	LINER KIT Liner Kit/ camisas de los cilindros/ Лайнер комплект	CYL. LINER Zylinderlaufbuchse/ camisas de los cilindros/ втулка цилиндра		PISTON + RINGS Kolben + Ringe/ Pistón + Anillos/ поршень и кольца		PISTON SET Kolben Set/ Pistón Set/ поршневой	RINGS SET Ring Set/ Anillos Set/ кольца		PIN Pin/ Perno/ Пин	
6D15		Liner/ Sleeve		Piston			Rings		Ø: Length:	
		Length: Outside Ø: Flange Ø: Flange depth:	206.0 125.0 132.8 10.0 +1.5	Length: Comp. height:	115.8 70.8 -11.7 -21.3		Top: 2nd: oil:	3.0 2.5 5.0		
6,919 cc 6 cyl 113.0 mm Bore Ø		Reference no.:		Reference no.:		Reference no.:	Reference no.:		Reference no.:	
		ME031654 ME031656 ME071041 ME071063		O-Ring: ME031601 ME031610 ME071066		ME032480 ME032593 ME032634 ME033963	ME032403 ME072306	ME032014 ME032015 ME033943		
NM-Motorservice Article no./ Artikelnummer/ Modelo número/ статья номер	NM-Motorservice Article no.:	NM-Motorservice Article no.:		NM-Motorservice Article no.:		NM-Motorservice Article no.:	NM-Motorservice Article no.:	NM-Motorservice Article no.:		
	LBS 44750 FA	LB 44750 F		KBS 44750 A		KB 44750 A	KR 44750	PB 44750		

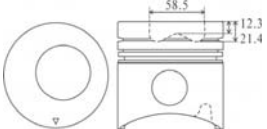

ENGINE TYPE Motortyp/ tipo de motor/ тип двигателя	LINER KIT Liner Kit/ camisas de los cilindros/ Лайнер комплект	CYL. LINER Zylinderlaufbuchse/ camisas de los cilindros/ втулка цилиндра	PISTON + RINGS Kolben + Ringe/ Pistón + Anillos/ поршень и кольца	PISTON SET Kolben Set/ Pistón Set/ поршневой	RINGS SET Ring Set/ Anillos Set/ кольца	PIN Pin/ Perno/ Пин	
6D15 6,919 cc 6 cyl 113.0 mm Bore Ø		Liner/ Sleeve	Piston		Rings		Ø : 38.0 Length: 90.0
		Length: Outside Ø: Flange Ø: Flange depth:	206.0 125.0 132.8 10.0 +1.5	Length: Comp. height:	116.0 71.0 -11.3 -21.1	Top: 2nd: oil:	
		Reference no.:	Reference no.:	Reference no.:	Reference no.:	Reference no.:	
		ME031654 ME031656 ME071041 ME071063	O-Ring: ME031601 ME031610 ME071066	ME033934 ME072033 ME072035	ME032403 ME072306	ME032014 ME032015 ME033943	
NM-Motorservice Article no./ Artikelnummer/ Modelo número/ статья номер	NM-Motorservice Article no.:	NM-Motorservice Article no.:	NM-Motorservice Article no.:	NM-Motorservice Article no.:	NM-Motorservice Article no.:	NM-Motorservice Article no.:	
	LBS 28050 FA	LB 28050 F	KBS 28050 A	KB 28050 A	KR 28050	PB 28050	

ENGINE TYPE Motortyp/ tipo de motor/ тип двигателя	LINER KIT Liner Kit/ camisas de los cilindros/ Лайнер комплект	CYL. LINER Zylinderlaufbuchse/ camisas de los cilindros/ втулка цилиндра	PISTON + RINGS Kolben + Ringe/ Pistón + Anillos/ поршень и кольца	PISTON SET Kolben Set/ Pistón Set/ поршневой	RINGS SET Ring Set/ Anillos Set/ кольца	PIN Pin/ Perno/ Пин	
6D15T 6,919 cc 6 cyl 113.0 mm Bore Ø		Liner/ Sleeve	Piston		Rings		Ø : 38.0 Length: 90.0
		Length: Outside Ø: Flange Ø: Flange depth:	211.0 125.0 132.8 10.0 +1.5	Length: Comp. height:	116.2 71.0 -12.1 -23.0	Top: 2nd: oil:	
		Reference no.:	Reference no.:	Reference no.:	Reference no.:	Reference no.:	
		ME071062 ME071063 ME071064	O-Ring: ME031601 ME031610 ME071066	ME032870 ME032871	ME032403 ME072306	ME032014 ME032015 ME033943	
NM-Motorservice Article no./ Artikelnummer/ Modelo número/ статья номер	NM-Motorservice Article no.:	NM-Motorservice Article no.:	NM-Motorservice Article no.:	NM-Motorservice Article no.:	NM-Motorservice Article no.:	NM-Motorservice Article no.:	
	LBS 28100 F LBS 28100 FA	LB 28100 F	KBS 28100 KBS 28100 A	KB 28100 KB 28100 A	KR 28100	PB 28100	

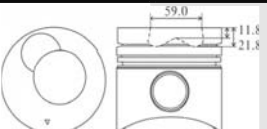
ENGINE TYPE Motortyp/ tipo de motor/ тип двигателя	LINER KIT Liner Kit/ camisas de los cilindros/ Лайнер комплект	CYL. LINER Zylinderlaufbuchse/ camisas de los cilindros/ втулка цилиндра	PISTON + RINGS Kolben + Ringe/ Pistón + Anillos/ поршень и кольца	PISTON SET Kolben Set/ Pistón Set/ поршневой	RINGS SET Ring Set/ Anillos Set/ кольца	PIN Pin/ Perno/ Пин	
6D15T New 6,919 cc 6 cyl 113.0 mm Bore Ø		Liner/ Sleeve	Piston		Rings		Ø : 38.0 Length: 92.0
		Length: Outside Ø: Flange Ø: Flange depth:	211.0 125.0 132.8 10.0 +1.5	Length: Comp. height:	116.1 71.1 -12.3 -21.4	Top: 2nd: oil:	
		Reference no.:	Reference no.:	Reference no.:	Reference no.:	Reference no.:	
		ME071062 ME071063 ME071064	O-Ring: ME031601 ME031610 ME071066	ME072055	ME997456 ME997466 ME999929 ME999954	ME072128	
NM-Motorservice Article no./ Artikelnummer/ Modelo número/ статья номер	NM-Motorservice Article no.:	NM-Motorservice Article no.:	NM-Motorservice Article no.:	NM-Motorservice Article no.:	NM-Motorservice Article no.:	NM-Motorservice Article no.:	
	LBS 28150 FA	LB 28150 F	KBS 28150 A	KB 28150 A	KR 28150	PB 28150	

ENGINE TYPE Motortyp/ tipo de motor/ тип двигателя	LINER KIT Liner Kit/ camisas de los cilindros/ Лайнер комплект	CYL. LINER Zylinderlaufbuchse/ camisas de los cilindros/ втулка цилиндра	PISTON + RINGS Kolben + Ringe/ Pistón + Anillos/ поршень и кольца	PISTON SET Kolben Set/ Pistón Set/ поршневой	RINGS SET Ring Set/ Anillos Set/ кольца	PIN Pin/ Perno/ Пин
6D15T • 3AT		Liner/ Sleeve	Piston		Rings	Ø : 38.0 Length: 92.0
		Length: 206.0 Outside Ø: 117.0 Flange Ø: 125.0 Flange depth: 8.0 +1.5	Length: 116.1 Comp. height: 71.1 -12.3 -21.4	Top: 2.8 2nd: 2.5 oil: 4.0		
6,919 cc 6 cyl 113.0 mm Bore Ø		Reference no.:		Reference no.:	Reference no.:	Reference no.:
		ME047574 ME071086/7/8/9 ME071090/1/2 ME071145		ME072055	ME997456 ME997466 ME999929 ME999954	ME072128
NM-Motorservice Article no./ Artikelnummer/ Modelo número/ статья номер	NM-Motorservice Article no.:	NM-Motorservice Article no.:	NM-Motorservice Article no.:	NM-Motorservice Article no.:	NM-Motorservice Article no.:	NM-Motorservice Article no.:
	LBS 28200 FA	LB 28200 F (phosphated)	KBS 28200 A	KB 28200 A	KR 28200	PB 28200

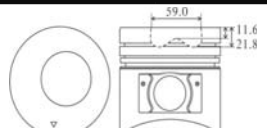
ENGINE TYPE Motortyp/ tipo de motor/ тип двигателя	LINER KIT Liner Kit/ camisas de los cilindros/ Лайнер комплект	CYL. LINER Zylinderlaufbuchse/ camisas de los cilindros/ втулка цилиндра	PISTON + RINGS Kolben + Ringe/ Pistón + Anillos/ поршень и кольца	PISTON SET Kolben Set/ Pistón Set/ поршневой	RINGS SET Ring Set/ Anillos Set/ кольца	PIN Pin/ Perno/ Пин
6D16		Liner/ Sleeve	Piston		Rings	Ø : 38.0 Length: 92.0
		Length: 205.0 Outside Ø: 122.0 Flange Ø: 128.0 Flange depth: 8.0	Length: 116.1 Comp. height: 71.1 -11.8 -21.8	Top: 3.0 2nd: 2.5 oil: 4.0		
7,545 cc 6 cyl 118.0 mm Bore Ø		Reference no.:		Reference no.:	Reference no.:	Reference no.:
		ME071224 ME071227 ME071225 ME071228 ME071226 ME071230		ME072000 ME072002	ME999540 ME999955	ME072128
NM-Motorservice Article no./ Artikelnummer/ Modelo número/ статья номер	NM-Motorservice Article no.:	NM-Motorservice Article no.:	NM-Motorservice Article no.:	NM-Motorservice Article no.:	NM-Motorservice Article no.:	NM-Motorservice Article no.:
	LBS 28250 FA	LB 28250 F (phosphated)	KBS 28250 A	KB 28250 A	KR 28250	PB 28250



ENGINE TYPE Motortyp/ tipo de motor/ тип двигателя	LINER KIT Liner Kit/ camisas de los cilindros/ Лайнер комплект	CYL. LINER Zylinderlaufbuchse/ camisas de los cilindros/ втулка цилиндра	PISTON + RINGS Kolben + Ringe/ Pistón + Anillos/ поршень и кольца	PISTON SET Kolben Set/ Pistón Set/ поршневой	RINGS SET Ring Set/ Anillos Set/ кольца	PIN Pin/ Perno/ Пин
6D16		Liner/ Sleeve	Piston		Rings	Ø : 38.0 Length: 92.0
		Length: 205.0 Outside Ø: 122.0 Flange Ø: 128.0 Flange depth: 8.0	Length: 116.1 Comp. height: 71.1 -11.8 -21.8	Top: 3.0 2nd: 2.5 oil: 4.0		
7,545 cc 6 cyl 118.0 mm Bore Ø		Reference no.:		Reference no.:	Reference no.:	Reference no.:
		ME071224 ME071227 ME071225 ME071228 ME071226 ME071230		ME072062	ME999540 ME999955	ME035380 ME035381 ME072126
NM-Motorservice Article no./ Artikelnummer/ Modelo número/ статья номер	NM-Motorservice Article no.:	NM-Motorservice Article no.:	NM-Motorservice Article no.:	NM-Motorservice Article no.:	NM-Motorservice Article no.:	NM-Motorservice Article no.:
	LBS 28300 FA	LB 28300 F (phosphated)	KBS 28300 A	KB 28300 A	KR 28300	PB 28300



ENGINE TYPE Motortyp/ tipo de motor/ тип двигателя	LINER KIT Liner Kit/ camisas de los cilindros/ Лайнер комплект	CYL. LINER Zylinderlaufbuchse/ camisas de los cilindros/ втулка цилиндра	PISTON + RINGS Kolben + Ringe/ Pistón + Anillos/ поршень и кольца	PISTON SET Kolben Set/ Pistón Set/ поршневой	RINGS SET Ring Set/ Anillos Set/ кольца	PIN Pin/ Perno/ Пин	
6D16T		Liner/ Sleeve	Piston		Rings		
			Length: Outside Ø: Flange Ø: Flange depth:	206.0 122.0 128.0 8.0 +1.5	Length: Comp. height:	116.1 71.1 -12.2 -22.7	Top: 2nd: oil:
7,545 cc 6 cyl 118.0 mm Bore Ø		Reference no.:		Reference no.:	Reference no.:	Reference no.:	
		ME041102 ME041105 ME041107		ME072065	ME996591 ME997467 ME997999 ME999549	ME072128	
NM-Motorservice Article no./ Artikelnummer/ Modelo número/ статья номер	NM-Motorservice Article no.:	NM-Motorservice Article no.:	NM-Motorservice Article no.:	NM-Motorservice Article no.:	NM-Motorservice Article no.:	NM-Motorservice Article no.:	
	LBS 28350 FA	LB 28350 F (phosphated)	KBS 28350 A	KB 28350 A	KR 28350	PB 28350	

ENGINE TYPE Motortyp/ tipo de motor/ тип двигателя	LINER KIT Liner Kit/ camisas de los cilindros/ Лайнер комплект	CYL. LINER Zylinderlaufbuchse/ camisas de los cilindros/ втулка цилиндра	PISTON + RINGS Kolben + Ringe/ Pistón + Anillos/ поршень и кольца	PISTON SET Kolben Set/ Pistón Set/ поршневой	RINGS SET Ring Set/ Anillos Set/ кольца	PIN Pin/ Perno/ Пин	
6D17	LBS 28400 FA consists of LB 28400 F	Flanged Flanged (-1F)	Piston		Rings		
			Length: Outside Ø: Flange Ø: Flange depth:	209.0 122.0 128.0 8.0 8.0 +1.5	Length: Comp. height:	111.1 66.1 -5.5 -23.1	Top: 2nd: oil:
8,201 cc 6 cyl 118.0 mm Bore Ø	LBS 28400-1 FA consists of LB 28400-1 F	Reference no.:		Reference no.:	Reference no.:	Reference no.:	
		ME071125 ME071537 ME071538 ME071543		ME072576	ME999540 ME999955	ME072128	
NM-Motorservice Article no./ Artikelnummer/ Modelo número/ статья номер	NM-Motorservice Article no.:	NM-Motorservice Article no.:	NM-Motorservice Article no.:	NM-Motorservice Article no.:	NM-Motorservice Article no.:	NM-Motorservice Article no.:	
	LBS 28400 FA LBS 28400-1 FA	LB 28400 F LB 28400-1 F (phosphated)	KBS 28400 A	KB 28400 A	KR 28400	PB 28400	

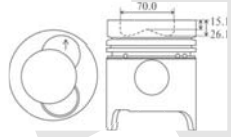
ENGINE TYPE Motortyp/ tipo de motor/ тип двигателя	LINER KIT Liner Kit/ camisas de los cilindros/ Лайнер комплект	CYL. LINER Zylinderlaufbuchse/ camisas de los cilindros/ втулка цилиндра	PISTON + RINGS Kolben + Ringe/ Pistón + Anillos/ поршень и кольца	PISTON SET Kolben Set/ Pistón Set/ поршневой	RINGS SET Ring Set/ Anillos Set/ кольца	PIN Pin/ Perno/ Пин	
6D20		Liner/ Sleeve	Piston		Rings		
			Length: Outside Ø: Flange Ø: Flange depth:	261.3 143.0 153.0 11.5 +1.3	Length: Comp. height:	155.5 83.0 -13.5 -23.4	Top: 2nd: oil:
10,308 cc 6 cyl 125.0 mm Bore Ø		Reference no.:	Reference no.:	Reference no.:	Reference no.:	Reference no.:	
		30907-10500 ME051157 ME051553 ME051554	O-Ring: 30907-00801 ME093520	30917-10101 30917-10103	ME052145	30319-00600 30319-00690 ME052158 ME052159 ME052603 ME052660	
NM-Motorservice Article no./ Artikelnummer/ Modelo número/ статья номер	NM-Motorservice Article no.:	NM-Motorservice Article no.:	NM-Motorservice Article no.:	NM-Motorservice Article no.:	NM-Motorservice Article no.:	NM-Motorservice Article no.:	
	LBS 28450 FA	LB 28450 F	KBS 28450 A	KB 28450 A	KR 28450	PB 28450	

ENGINE TYPE Motortyp/ tipo de motor/ тип двигателя	LINER KIT Liner Kit/ camisas de los cilindros/ Лайнер комплект	CYL. LINER Zylinderlaufbuchse/ camisas de los cilindros/ втулка цилиндра		PISTON + RINGS Kolben + Ringe/ Pistón + Anillos/ поршень и кольца		PISTON SET Kolben Set/ Pistón Set/ поршневой	RINGS SET Ring Set/ Anillos Set/ кольца		PIN Pin/ Perno/ Пин	
6D20		Liner/ Sleeve		Piston			Rings		Ø : 50.0 Length: 101.0	Reference no.:
		Length: Outside Ø: Flange Ø: Flange depth:	261.3 143.0 153.0 11.5 +1.3		Length: Comp. height:		158.2 83.2 -22.7	Top: 2nd: oil:		
10,308 cc 6 cyl 125.0 mm Bore Ø		Reference no.:		Reference no.:		Reference no.:	Reference no.:		30319-00600 30319-00690 ME052158 ME052159 ME052603 ME052660	
		30907-10500 ME051157 ME051553 ME051554		O-Ring: 30907-00801 ME093520		ME052264	30917-01012 30917-01013			
NM-Motorservice Article no./ Artikelnummer/ Modelo número/ статья номер	NM-Motorservice Article no.:	NM-Motorservice Article no.:		NM-Motorservice Article no.:		NM-Motorservice Article no.:	NM-Motorservice Article no.:		NM-Motorservice Article no.:	
	LBS 28500 FA	LB 28500 F		KBS 28500 A		KB 28500 A	KR 28500		PB 28500	

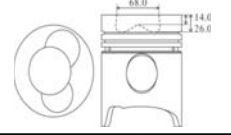
ENGINE TYPE Motortyp/ tipo de motor/ тип двигателя	LINER KIT Liner Kit/ camisas de los cilindros/ Лайнер комплект	CYL. LINER Zylinderlaufbuchse/ camisas de los cilindros/ втулка цилиндра		PISTON + RINGS Kolben + Ringe/ Pistón + Anillos/ поршень и кольца		PISTON SET Kolben Set/ Pistón Set/ поршневой	RINGS SET Ring Set/ Anillos Set/ кольца		PIN Pin/ Perno/ Пин	
6D22		Liner/ Sleeve		Piston			Rings		Ø : 50.0 Length: 105.0	Reference no.:
		Length: Outside Ø: Flange Ø: Flange depth:	262.0 147.0 156.0 11.5 +1.8		Length: Comp. height:		158.0 82.9 -15.1 -26.1	Top: 2nd: oil:		
11,149 cc 6 cyl 130.0 mm Bore Ø		Reference no.:		Reference no.:		Reference no.:	Reference no.:		30319-00600 30319-00690 ME052158 ME052159 ME052603 ME052660	
		ME051217 ME051500 ME051501 ME051502 ME051503		O-Ring: 30907-22300 31107-02401 ME051375		ME052447 ME052448 ME052449	30917-20010 ME052124 ME052787			
NM-Motorservice Article no./ Artikelnummer/ Modelo número/ статья номер	NM-Motorservice Article no.:	NM-Motorservice Article no.:		NM-Motorservice Article no.:		NM-Motorservice Article no.:	NM-Motorservice Article no.:		NM-Motorservice Article no.:	
	LBS 28550 FA	LB 28550 F		KBS 28550 A		KB 28550 A	KR 28550		PB 28550	

ENGINE TYPE Motortyp/ tipo de motor/ тип двигателя	LINER KIT Liner Kit/ camisas de los cilindros/ Лайнер комплект	CYL. LINER Zylinderlaufbuchse/ camisas de los cilindros/ втулка цилиндра		PISTON + RINGS Kolben + Ringe/ Pistón + Anillos/ поршень и кольца		PISTON SET Kolben Set/ Pistón Set/ поршневой	RINGS SET Ring Set/ Anillos Set/ кольца		PIN Pin/ Perno/ Пин	
6D22		Liner/ Sleeve		Piston			Rings		Ø : 50.0 Length: 105.0	Reference no.:
		Length: Outside Ø: Flange Ø: Flange depth:	262.0 147.0 156.0 11.5 +1.8		Length: Comp. height:		158.0 83.0 -14.0 -26.0	Top: 2nd: oil:		
11,149 cc 6 cyl 130.0 mm Bore Ø		Reference no.:		Reference no.:		Reference no.:	Reference no.:		30319-00600 30319-00690 ME052158 ME052159 ME052603 ME052660	
		ME051217 ME051500 ME051501 ME051502 ME051503		O-Ring: 30907-22300 31107-02401 ME051375		ME052902	30917-20010 ME052124 ME052787			
NM-Motorservice Article no./ Artikelnummer/ Modelo número/ статья номер	NM-Motorservice Article no.:	NM-Motorservice Article no.:		NM-Motorservice Article no.:		NM-Motorservice Article no.:	NM-Motorservice Article no.:		NM-Motorservice Article no.:	
	LBS 28600 FA	LB 28600 F		KBS 28600 A		KB 28600 A	KR 28600		PB 28600	

ENGINE TYPE Motortyp/ tipo de motor/ тип двигателя	LINER KIT Liner Kit/ camisas de los cilindros/ Лайнер комплект	CYL. LINER Zylinderlaufbuchse/ camisas de los cilindros/ втулка цилиндра	PISTON + RINGS Kolben + Ringe/ Pistón + Anillos/ поршень и кольца	PISTON SET Kolben Set/ Pistón Set/ поршневой	RINGS SET Ring Set/ Anillos Set/ кольца	PIN Pin/ Perno/ Пин																																								
6D22T		<table border="1"> <tr> <td></td> <td>Liner/ Sleeve</td> <td></td> </tr> <tr> <td>Length:</td> <td>262.0</td> <td></td> </tr> <tr> <td>Outside Ø:</td> <td>147.0</td> <td></td> </tr> <tr> <td>Flange Ø:</td> <td>156.0</td> <td></td> </tr> <tr> <td>Flange depth:</td> <td>11.5 +1.8</td> <td></td> </tr> </table>		Liner/ Sleeve		Length:	262.0		Outside Ø:	147.0		Flange Ø:	156.0		Flange depth:	11.5 +1.8		<table border="1"> <tr> <td></td> <td>Piston</td> <td></td> </tr> <tr> <td>Length:</td> <td>158.1</td> <td></td> </tr> <tr> <td>Comp. height:</td> <td>83.1 -12.3 -23.3</td> <td></td> </tr> </table>		Piston		Length:	158.1		Comp. height:	83.1 -12.3 -23.3			<table border="1"> <tr> <td></td> <td>Rings</td> <td></td> </tr> <tr> <td>Top:</td> <td>3.3</td> <td></td> </tr> <tr> <td>2nd:</td> <td>3.0</td> <td></td> </tr> <tr> <td>oil:</td> <td>6.0</td> <td></td> </tr> </table>		Rings		Top:	3.3		2nd:	3.0		oil:	6.0		<table border="1"> <tr> <td>Ø:</td> <td>50.0</td> </tr> <tr> <td>Length:</td> <td>105.0</td> </tr> </table>	Ø:	50.0	Length:	105.0
				Liner/ Sleeve																																										
Length:	262.0																																													
Outside Ø:	147.0																																													
Flange Ø:	156.0																																													
Flange depth:	11.5 +1.8																																													
	Piston																																													
Length:	158.1																																													
Comp. height:	83.1 -12.3 -23.3																																													
	Rings																																													
Top:	3.3																																													
2nd:	3.0																																													
oil:	6.0																																													
Ø:	50.0																																													
Length:	105.0																																													
11,149 cc 6 cyl 130.0 mm Bore Ø						Reference no.:																																								
		Reference no.:	Reference no.:	Reference no.:	Reference no.:	30319-00600																																								
						ME051217 ME051500 ME051501 ME051502 ME051503	O-Ring: 30907-22300 31107-02401 ME051375	ME052665 ME052540	30917-20010 ME052124 ME052787	30319-00690 ME052158 ME052159 ME052603 ME052660																																				
NM-Motorservice Article no./ Artikelnummer/ Modelo número/ статья номер	NM-Motorservice Article no.:	NM-Motorservice Article no.:	NM-Motorservice Article no.:	NM-Motorservice Article no.:	NM-Motorservice Article no.:	NM-Motorservice Article no.:																																								
	LBS 28650 FA	LB 28650 F	KBS 28650 A	KB 28650 A	KR 28650	PB 28650																																								

ENGINE TYPE Motortyp/ tipo de motor/ тип двигателя	LINER KIT Liner Kit/ camisas de los cilindros/ Лайнер комплект	CYL. LINER Zylinderlaufbuchse/ camisas de los cilindros/ втулка цилиндра	PISTON + RINGS Kolben + Ringe/ Pistón + Anillos/ поршень и кольца	PISTON SET Kolben Set/ Pistón Set/ поршневой	RINGS SET Ring Set/ Anillos Set/ кольца	PIN Pin/ Perno/ Пин																																								
6D22T		<table border="1"> <tr> <td></td> <td>Liner/ Sleeve</td> <td></td> </tr> <tr> <td>Length:</td> <td>262.0</td> <td></td> </tr> <tr> <td>Outside Ø:</td> <td>147.0</td> <td></td> </tr> <tr> <td>Flange Ø:</td> <td>156.0</td> <td></td> </tr> <tr> <td>Flange depth:</td> <td>11.5 +1.8</td> <td></td> </tr> </table>		Liner/ Sleeve		Length:	262.0		Outside Ø:	147.0		Flange Ø:	156.0		Flange depth:	11.5 +1.8		<table border="1"> <tr> <td></td> <td>Piston</td> <td></td> </tr> <tr> <td>Length:</td> <td>158.2</td> <td></td> </tr> <tr> <td>Comp. height:</td> <td>83.1 -12.3 -23.3</td> <td></td> </tr> </table>		Piston		Length:	158.2		Comp. height:	83.1 -12.3 -23.3			<table border="1"> <tr> <td></td> <td>Rings</td> <td></td> </tr> <tr> <td>Top:</td> <td>3.3</td> <td></td> </tr> <tr> <td>2nd:</td> <td>3.0</td> <td></td> </tr> <tr> <td>oil:</td> <td>6.0</td> <td></td> </tr> </table>		Rings		Top:	3.3		2nd:	3.0		oil:	6.0		<table border="1"> <tr> <td>Ø:</td> <td>50.0</td> </tr> <tr> <td>Length:</td> <td>105.0</td> </tr> </table>	Ø:	50.0	Length:	105.0
				Liner/ Sleeve																																										
Length:	262.0																																													
Outside Ø:	147.0																																													
Flange Ø:	156.0																																													
Flange depth:	11.5 +1.8																																													
	Piston																																													
Length:	158.2																																													
Comp. height:	83.1 -12.3 -23.3																																													
	Rings																																													
Top:	3.3																																													
2nd:	3.0																																													
oil:	6.0																																													
Ø:	50.0																																													
Length:	105.0																																													
11,149 cc 6 cyl 130.0 mm Bore Ø						Reference no.:																																								
		Reference no.:	Reference no.:	Reference no.:	Reference no.:	30319-00600																																								
						ME051217 ME051500 ME051501 ME051502 ME051503	O-Ring: 30907-22300 31107-02401 ME051375	ME052730	30917-20010 ME052124 ME052787	30319-00690 ME052158 ME052159 ME052603 ME052660																																				
NM-Motorservice Article no./ Artikelnummer/ Modelo número/ статья номер	NM-Motorservice Article no.:	NM-Motorservice Article no.:	NM-Motorservice Article no.:	NM-Motorservice Article no.:	NM-Motorservice Article no.:	NM-Motorservice Article no.:																																								
	LBS 28700 FA	LB 28700 F	KBS 28700 A	KB 28700 A	KR 28700	PB 28700																																								

ENGINE TYPE Motortyp/ tipo de motor/ тип двигателя	LINER KIT Liner Kit/ camisas de los cilindros/ Лайнер комплект	CYL. LINER Zylinderlaufbuchse/ camisas de los cilindros/ втулка цилиндра	PISTON + RINGS Kolben + Ringe/ Pistón + Anillos/ поршень и кольца	PISTON SET Kolben Set/ Pistón Set/ поршневой	RINGS SET Ring Set/ Anillos Set/ кольца	PIN Pin/ Perno/ Пин																																								
6D22 • 3AT		<table border="1"> <tr> <td></td> <td>Liner/ Sleeve</td> <td></td> </tr> <tr> <td>Length:</td> <td>262.0</td> <td></td> </tr> <tr> <td>Outside Ø:</td> <td>147.0</td> <td></td> </tr> <tr> <td>Flange Ø:</td> <td>156.0</td> <td></td> </tr> <tr> <td>Flange depth:</td> <td>11.5 +1.8</td> <td></td> </tr> </table>		Liner/ Sleeve		Length:	262.0		Outside Ø:	147.0		Flange Ø:	156.0		Flange depth:	11.5 +1.8		<table border="1"> <tr> <td></td> <td>Piston</td> <td></td> </tr> <tr> <td>Length:</td> <td>158.2</td> <td></td> </tr> <tr> <td>Comp. height:</td> <td>83.1 -12.7 -23.5</td> <td></td> </tr> </table>		Piston		Length:	158.2		Comp. height:	83.1 -12.7 -23.5		Alfin and with oil gallery	<table border="1"> <tr> <td></td> <td>Rings</td> <td></td> </tr> <tr> <td>Top:</td> <td>3.3</td> <td></td> </tr> <tr> <td>2nd:</td> <td>3.0</td> <td></td> </tr> <tr> <td>oil:</td> <td>4.0</td> <td></td> </tr> </table>		Rings		Top:	3.3		2nd:	3.0		oil:	4.0		<table border="1"> <tr> <td>Ø:</td> <td>50.0</td> </tr> <tr> <td>Length:</td> <td>105.0</td> </tr> </table>	Ø:	50.0	Length:	105.0
				Liner/ Sleeve																																										
Length:	262.0																																													
Outside Ø:	147.0																																													
Flange Ø:	156.0																																													
Flange depth:	11.5 +1.8																																													
	Piston																																													
Length:	158.2																																													
Comp. height:	83.1 -12.7 -23.5																																													
	Rings																																													
Top:	3.3																																													
2nd:	3.0																																													
oil:	4.0																																													
Ø:	50.0																																													
Length:	105.0																																													
11,149 cc 6 cyl 130.0 mm Bore Ø						Reference no.:																																								
		Reference no.:	Reference no.:	Reference no.:	Reference no.:	30319-00600																																								
						ME051217 ME051500 ME051501 ME051502 ME051503	O-Ring: 30907-22300 31107-02401 ME051375	ME052792	ME052889 ME052893 ME151190	30319-00690 ME052158 ME052159 ME052603 ME052660																																				
NM-Motorservice Article no./ Artikelnummer/ Modelo número/ статья номер	NM-Motorservice Article no.:	NM-Motorservice Article no.:	NM-Motorservice Article no.:	NM-Motorservice Article no.:	NM-Motorservice Article no.:	NM-Motorservice Article no.:																																								
	LBS 28750 FB	LB 28750 F	KBS 28750 B	KB 28750 B	KR 28750	PB 28750																																								

ENGINE TYPE Motortyp/ tipo de motor/ тип двигателя	LINER KIT Liner Kit/ camisas de los cilindros/ Лайнер комплект	CYL. LINER Zylinderlaufbuchse/ camisas de los cilindros/ втулка цилиндра	PISTON + RINGS Kolben + Ringe/ Pistón + Anillos/ поршень и кольца	PISTON SET Kolben Set/ Pistón Set/ поршневой	RINGS SET Ring Set/ Anillos Set/ кольца	PIN Pin/ Perno/ Пин	
6D24 11,945 cc 6 cyl 130.0 mm Bore Ø		Liner/ Sleeve	Piston		Alfin and with oil gallery	Rings	
		Length: Outside Ø: Flange Ø: Flange depth:	262.0 147.0 156.0 11.5 +1.8	Length: Comp. height:		153.2 78.2 -11.8 -26.2	Top: 2nd: oil:
		Reference no.:	Reference no.:	Reference no.:	Reference no.:	Reference no.:	
		ME051217 ME051500 ME051501 ME051502 ME051503	O-Ring: 30907-22300 31107-02401 ME051375	ME151409 ME151413 ME151414 ME151415	ME052889 ME052893 ME151190	ME151450	
NM-Motorservice Article no./ Artikelnummer/ Modelo número/ статья номер	NM-Motorservice Article no.:	NM-Motorservice Article no.:	NM-Motorservice Article no.:	NM-Motorservice Article no.:	NM-Motorservice Article no.:	NM-Motorservice Article no.:	
	LBS 28800 FB	LB 28800 F	KBS 28800 B	KB 28800 B	KR 28800	PB 28800	



ENGINE TYPE Motortyp/ tipo de motor/ тип двигателя	LINER KIT Liner Kit/ camisas de los cilindros/ Лайнер комплект	CYL. LINER Zylinderlaufbuchse/ camisas de los cilindros/ втулка цилиндра	PISTON + RINGS Kolben + Ringe/ Pistón + Anillos/ поршень и кольца	PISTON SET Kolben Set/ Pistón Set/ поршневой	RINGS SET Ring Set/ Anillos Set/ кольца	PIN Pin/ Perno/ Пин	
6D24 • 3V 11,945 cc 6 cyl 130.0 mm Bore Ø		Liner/ Sleeve	Piston		Alfin and with oil gallery	Rings	
		Length: Outside Ø: Flange Ø: Flange depth:	262.0 147.0 156.0 11.5 +1.8	Length: Comp. height:		153.2 78.2 -11.8 -26.2	Top: 2nd: oil:
		Reference no.:	Reference no.:	Reference no.:	Reference no.:	Reference no.:	
		ME051217 ME051500 ME051501 ME051502 ME051503	O-Ring: 30907-22300 31107-02401 ME051375	ME151416 ME151420 ME151421 ME151422	ME052889 ME052893 ME151190	ME151450	
NM-Motorservice Article no./ Artikelnummer/ Modelo número/ статья номер	NM-Motorservice Article no.:	NM-Motorservice Article no.:	NM-Motorservice Article no.:	NM-Motorservice Article no.:	NM-Motorservice Article no.:	NM-Motorservice Article no.:	
	LBS 28850 FB	LB 28850 F	KBS 28850 B	KB 28850 B	KR 28850	PB 28850	



ENGINE TYPE Motortyp/ tipo de motor/ тип двигателя	LINER KIT Liner Kit/ camisas de los cilindros/ Лайнер комплект	CYL. LINER Zylinderlaufbuchse/ camisas de los cilindros/ втулка цилиндра	PISTON + RINGS Kolben + Ringe/ Pistón + Anillos/ поршень и кольца	PISTON SET Kolben Set/ Pistón Set/ поршневой	RINGS SET Ring Set/ Anillos Set/ кольца	PIN Pin/ Perno/ Пин	
6D24 11,945 cc 6 cyl 130.0 mm Bore Ø		Liner/ Sleeve	Piston			Rings	
		Length: Outside Ø: Flange Ø: Flange depth:	262.0 147.0 156.0 11.5 +1.8	Length: Comp. height:		153.2 78.2 -11.8 -26.2	Top: 2nd: oil:
		Reference no.:	Reference no.:	Reference no.:	Reference no.:	Reference no.:	
		ME051217 ME051500 ME051501 ME051502 ME051503	O-Ring: 30907-22300 31107-02401 ME051375	ME151395 ME151399 ME151400 ME151401	ME052889 ME052893 ME151190	ME151450	
NM-Motorservice Article no./ Artikelnummer/ Modelo número/ статья номер	NM-Motorservice Article no.:	NM-Motorservice Article no.:	NM-Motorservice Article no.:	NM-Motorservice Article no.:	NM-Motorservice Article no.:	NM-Motorservice Article no.:	
	LBS 28900 FA	LB 28900 F	KBS 28900 A	KB 28900 A	KR 28900	PB 28900	

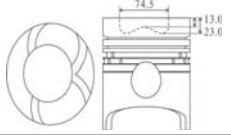

ENGINE TYPE Motortyp/ tipo de motor/ тип двигателя	LINER KIT Liner Kit/ camisas de los cilindros/ Лайнер комплект	CYL. LINER Zylinderlaufbuchse/ camisas de los cilindros/ втулка цилиндра	PISTON + RINGS Kolben + Ringe/ Pistón + Anillos/ поршень и кольца	PISTON SET Kolben Set/ Pistón Set/ поршневой	RINGS SET Ring Set/ Anillos Set/ кольца	PIN Pin/ Perno/ Пин
6D24 • 3V		Liner/ Sleeve	Piston		Rings	Ø : Length:
11,945 cc 6 cyl 130.0 mm Bore Ø		Reference no.:	Reference no.:	Reference no.:	Reference no.:	Reference no.:
		ME051217 ME051500 ME051501 ME051502 ME051503	O-Ring: 30907-22300 31107-02401 ME051375	ME151402 ME151406 ME151407 ME151408	ME052889 ME052893 ME151190	ME151450
NM-Motorservice Article no./ Artikelnummer/ Modelo número/ статья номер	NM-Motorservice Article no.:	NM-Motorservice Article no.:	NM-Motorservice Article no.:	NM-Motorservice Article no.:	NM-Motorservice Article no.:	NM-Motorservice Article no.:
	LBS 28950 FA	LB 28950 F	KBS 28950 A	KB 28950 A	KR 28950	PB 28950

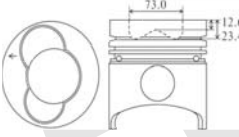

ENGINE TYPE Motortyp/ tipo de motor/ тип двигателя	LINER KIT Liner Kit/ camisas de los cilindros/ Лайнер комплект	CYL. LINER Zylinderlaufbuchse/ camisas de los cilindros/ втулка цилиндра	PISTON + RINGS Kolben + Ringe/ Pistón + Anillos/ поршень и кольца	PISTON SET Kolben Set/ Pistón Set/ поршневой	RINGS SET Ring Set/ Anillos Set/ кольца	PIN Pin/ Perno/ Пин
8DC4		Liner/ Sleeve	Piston		Rings	Ø : Length:
13,273 cc 8 cyl 130.0 mm Bore Ø		229.3 147.0 157.0 11.8 +1.3	145.2 80.4 -8.5 -21.2		3.3 3.0 6.0	45.0 108.0
		Reference no.:	Reference no.:	Reference no.:	Reference no.:	Reference no.:
		31207-43401 31207-43402 31207-72503 31207-72603 31207-72604 ME062526	O-Ring: 31107-02401 31107-03500	31217-50105 31217-56103 ME062273	ME062298	31219-70600
NM-Motorservice Article no./ Artikelnummer/ Modelo número/ статья номер	NM-Motorservice Article no.:	NM-Motorservice Article no.:	NM-Motorservice Article no.:	NM-Motorservice Article no.:	NM-Motorservice Article no.:	NM-Motorservice Article no.:
	LBS 29000 FA	LB 29000 F (water jacket chromed)	KBS 29000 A	KB 29000 A	KR 29000	PB 29000

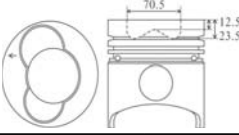

ENGINE TYPE Motortyp/ tipo de motor/ тип двигателя	LINER KIT Liner Kit/ camisas de los cilindros/ Лайнер комплект	CYL. LINER Zylinderlaufbuchse/ camisas de los cilindros/ втулка цилиндра	PISTON + RINGS Kolben + Ringe/ Pistón + Anillos/ поршень и кольца	PISTON SET Kolben Set/ Pistón Set/ поршневой	RINGS SET Ring Set/ Anillos Set/ кольца	PIN Pin/ Perno/ Пин
8DC2		Liner/ Sleeve	Piston		Rings	Ø : Length:
13,273 cc 8 cyl 130.0 mm Bore Ø		229.3 147.0 157.0 11.8 +1.3	145.0 80.3 -2.6 -11.5		4.0 3.0 6.0	45.0 108.0
		Reference no.:	Reference no.:	Reference no.:	Reference no.:	Reference no.:
		31207-43401 31207-43402 31207-72503 31207-72603 31207-72604 ME062526	O-Ring: 31107-02401 31107-03500	31217-77101	31217-02010 ME062109 ME062117	31219-70600
NM-Motorservice Article no./ Artikelnummer/ Modelo número/ статья номер	NM-Motorservice Article no.:	NM-Motorservice Article no.:	NM-Motorservice Article no.:	NM-Motorservice Article no.:	NM-Motorservice Article no.:	NM-Motorservice Article no.:
	LBS 29050 FA	LB 29050 F (water jacket chromed)	KBS 29050 A	KB 29050 A	KR 29050	PB 29050

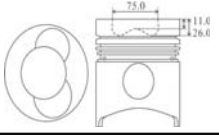

ENGINE TYPE Motortyp/ tipo de motor/ тип двигателя	LINER KIT Liner Kit/ camisas de los cilindros/ Лайнер комплект	CYL. LINER Zylinderlaufbuchse/ camisas de los cilindros/ втулка цилиндра		PISTON + RINGS Kolben + Ringe/ Pistón + Anillos/ поршень и кольца		PISTON SET Kolben Set/ Pistón Set/ поршневой	RINGS SET Ring Set/ Anillos Set/ кольца		PIN Pin/ Perno/ Пин	
8DC8		Liner/ Sleeve		Piston			Rings		Ø : 45.0 Length: 108.0	
		Length: 229.3 Outside Ø: 154.0 Flange Ø: 163.0 Flange depth: 11.8 +1.0		Length: 142.8 Comp. height: 78.0 -13.0 -23.0				Top: 4.0 2nd: 3.0 oil: 6.0		
14,886 cc 8 cyl 135.0 mm Bore Ø										
										
NM-Motorservice Article no./ Artikelnummer/ Modelo número/ статья номер	NM-Motorservice Article no.:	NM-Motorservice Article no.:		NM-Motorservice Article no.:	NM-Motorservice Article no.:	NM-Motorservice Article no.:	NM-Motorservice Article no.:	NM-Motorservice Article no.:	NM-Motorservice Article no.:	NM-Motorservice Article no.:
	LBS 29100 FA	LB 29100 F (water jacket chromed)		KBS 29100 A	KB 29100 A	ME062287	31217-60012 ME062086		31219-70600	

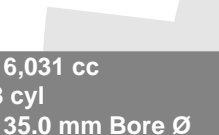

ENGINE TYPE Motortyp/ tipo de motor/ тип двигателя	LINER KIT Liner Kit/ camisas de los cilindros/ Лайнер комплект	CYL. LINER Zylinderlaufbuchse/ camisas de los cilindros/ втулка цилиндра		PISTON + RINGS Kolben + Ringe/ Pistón + Anillos/ поршень и кольца		PISTON SET Kolben Set/ Pistón Set/ поршневой	RINGS SET Ring Set/ Anillos Set/ кольца		PIN Pin/ Perno/ Пин	
8DC81		Liner/ Sleeve		Piston			Rings		Ø : 45.0 Length: 108.0	
		Length: 229.3 Outside Ø: 154.0 Flange Ø: 163.0 Flange depth: 11.8 +1.0		Length: 143.0 Comp. height: 78.0 -12.6 -23.4				Top: 3.3 2nd: 3.0 oil: 6.0		
14,886 cc 8 cyl 135.0 mm Bore Ø										
										
NM-Motorservice Article no./ Artikelnummer/ Modelo número/ статья номер	NM-Motorservice Article no.:	NM-Motorservice Article no.:		NM-Motorservice Article no.:	NM-Motorservice Article no.:	NM-Motorservice Article no.:	NM-Motorservice Article no.:	NM-Motorservice Article no.:	NM-Motorservice Article no.:	NM-Motorservice Article no.:
	LBS 29150 FA	LB 29150 F (water jacket chromed)		KBS 29150 A	KB 29150 A	ME062422	ME062022 ME062246 ME065684		31219-70600	

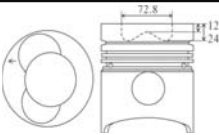

ENGINE TYPE Motortyp/ tipo de motor/ тип двигателя	LINER KIT Liner Kit/ camisas de los cilindros/ Лайнер комплект	CYL. LINER Zylinderlaufbuchse/ camisas de los cilindros/ втулка цилиндра		PISTON + RINGS Kolben + Ringe/ Pistón + Anillos/ поршень и кольца		PISTON SET Kolben Set/ Pistón Set/ поршневой	RINGS SET Ring Set/ Anillos Set/ кольца		PIN Pin/ Perno/ Пин	
8DC82		Liner/ Sleeve		Piston			Rings		Ø : 45.0 Length: 108.0	
		Length: 229.3 Outside Ø: 154.0 Flange Ø: 163.0 Flange depth: 11.8 +1.0		Length: 143.1 Comp. height: 78.1 -12.5 -23.5				Top: 3.3 2nd: 3.0 oil: 4.0		
14,886 cc 8 cyl 135.0 mm Bore Ø										
										
NM-Motorservice Article no./ Artikelnummer/ Modelo número/ статья номер	NM-Motorservice Article no.:	NM-Motorservice Article no.:		NM-Motorservice Article no.:	NM-Motorservice Article no.:	NM-Motorservice Article no.:	NM-Motorservice Article no.:	NM-Motorservice Article no.:	NM-Motorservice Article no.:	NM-Motorservice Article no.:
	LBS 29200 FA	LB 29200 F (water jacket chromed)		KBS 29200 A	KB 29200 A	ME090717	ME090574		31219-70600	

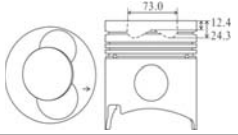

ENGINE TYPE Motortyp/ tipo de motor/ тип двигателя	LINER KIT Liner Kit/ camisas de los cilindros/ Лайнер комплект	CYL. LINER Zylinderlaufbuchse/ camisas de los cilindros/ втулка цилиндра	PISTON + RINGS Kolben + Ringe/ Pistón + Anillos/ поршень и кольца	PISTON SET Kolben Set/ Pistón Set/ поршневой	RINGS SET Ring Set/ Anillos Set/ кольца	PIN Pin/ Perno/ Пин																																								
8DC9		<table border="1"> <tr> <td></td> <td>Liner/ Sleeve</td> <td></td> </tr> <tr> <td>Length:</td> <td>260.0</td> <td></td> </tr> <tr> <td>Outside Ø:</td> <td>154.0</td> <td></td> </tr> <tr> <td>Flange Ø:</td> <td>163.0</td> <td></td> </tr> <tr> <td>Flange depth:</td> <td>11.8 +1.2</td> <td></td> </tr> </table>		Liner/ Sleeve		Length:	260.0		Outside Ø:	154.0		Flange Ø:	163.0		Flange depth:	11.8 +1.2		<table border="1"> <tr> <td></td> <td>Piston</td> <td></td> </tr> <tr> <td>Length:</td> <td>153.0</td> <td></td> </tr> <tr> <td>Comp. height:</td> <td>88.0 -11.0 -26.0</td> <td></td> </tr> </table>		Piston		Length:	153.0		Comp. height:	88.0 -11.0 -26.0			<table border="1"> <tr> <td></td> <td>Rings</td> <td></td> </tr> <tr> <td>Top:</td> <td>3.3</td> <td rowspan="4"> <table border="1"> <tr> <td>Ø:</td> <td>50.0</td> </tr> <tr> <td>Length:</td> <td>112.0</td> </tr> </table> </td> </tr> <tr> <td>2nd:</td> <td>3.0</td> </tr> <tr> <td>3rd:</td> <td>3.0</td> </tr> <tr> <td>oil:</td> <td>6.0</td> </tr> </table>		Rings		Top:	3.3	<table border="1"> <tr> <td>Ø:</td> <td>50.0</td> </tr> <tr> <td>Length:</td> <td>112.0</td> </tr> </table>	Ø:	50.0	Length:	112.0	2nd:	3.0	3rd:	3.0	oil:	6.0	
				Liner/ Sleeve																																										
Length:	260.0																																													
Outside Ø:	154.0																																													
Flange Ø:	163.0																																													
Flange depth:	11.8 +1.2																																													
	Piston																																													
Length:	153.0																																													
Comp. height:	88.0 -11.0 -26.0																																													
	Rings																																													
Top:	3.3	<table border="1"> <tr> <td>Ø:</td> <td>50.0</td> </tr> <tr> <td>Length:</td> <td>112.0</td> </tr> </table>	Ø:	50.0	Length:	112.0																																								
Ø:	50.0																																													
Length:	112.0																																													
2nd:	3.0																																													
3rd:	3.0																																													
oil:	6.0																																													
16,031 cc 8 cyl 135.0 mm Bore Ø																																														
		Reference no.:	Reference no.:	Reference no.:	Reference no.:	Reference no.:																																								
		ME061782	O-Ring: 31207-62302 31207-62400 31207-62401	ME062408	ME062018 ME062230	31219-34300 31219-34390 ME062310																																								
NM-Motorservice Article no./ Artikelnummer/ Modelo número/ статья номер	NM-Motorservice Article no.:	NM-Motorservice Article no.:	NM-Motorservice Article no.:	NM-Motorservice Article no.:	NM-Motorservice Article no.:	NM-Motorservice Article no.:																																								
	LBS 29250 FA	LB 29250 F (water jacket chromed)	KBS 29250 A	KB 29250 A	KR 29250	PB 29250																																								

ENGINE TYPE Motortyp/ tipo de motor/ тип двигателя	LINER KIT Liner Kit/ camisas de los cilindros/ Лайнер комплект	CYL. LINER Zylinderlaufbuchse/ camisas de los cilindros/ втулка цилиндра	PISTON + RINGS Kolben + Ringe/ Pistón + Anillos/ поршень и кольца	PISTON SET Kolben Set/ Pistón Set/ поршневой	RINGS SET Ring Set/ Anillos Set/ кольца	PIN Pin/ Perno/ Пин																																								
8DC9T		<table border="1"> <tr> <td></td> <td>Liner/ Sleeve</td> <td></td> </tr> <tr> <td>Length:</td> <td>260.0</td> <td></td> </tr> <tr> <td>Outside Ø:</td> <td>154.0</td> <td></td> </tr> <tr> <td>Flange Ø:</td> <td>163.0</td> <td></td> </tr> <tr> <td>Flange depth:</td> <td>11.8 +1.2</td> <td></td> </tr> </table>		Liner/ Sleeve		Length:	260.0		Outside Ø:	154.0		Flange Ø:	163.0		Flange depth:	11.8 +1.2		<table border="1"> <tr> <td></td> <td>Piston</td> <td></td> </tr> <tr> <td>Length:</td> <td>153.0</td> <td></td> </tr> <tr> <td>Comp. height:</td> <td>88.0 -12.4 -24.4</td> <td></td> </tr> </table>		Piston		Length:	153.0		Comp. height:	88.0 -12.4 -24.4			<table border="1"> <tr> <td></td> <td>Rings</td> <td></td> </tr> <tr> <td>Top:</td> <td>3.3</td> <td rowspan="4"> <table border="1"> <tr> <td>Ø:</td> <td>50.0</td> </tr> <tr> <td>Length:</td> <td>112.0</td> </tr> </table> </td> </tr> <tr> <td>2nd:</td> <td>3.0</td> </tr> <tr> <td>3rd:</td> <td>3.0</td> </tr> <tr> <td>oil:</td> <td>6.0</td> </tr> </table>		Rings		Top:	3.3	<table border="1"> <tr> <td>Ø:</td> <td>50.0</td> </tr> <tr> <td>Length:</td> <td>112.0</td> </tr> </table>	Ø:	50.0	Length:	112.0	2nd:	3.0	3rd:	3.0	oil:	6.0	
				Liner/ Sleeve																																										
Length:	260.0																																													
Outside Ø:	154.0																																													
Flange Ø:	163.0																																													
Flange depth:	11.8 +1.2																																													
	Piston																																													
Length:	153.0																																													
Comp. height:	88.0 -12.4 -24.4																																													
	Rings																																													
Top:	3.3	<table border="1"> <tr> <td>Ø:</td> <td>50.0</td> </tr> <tr> <td>Length:</td> <td>112.0</td> </tr> </table>	Ø:	50.0	Length:	112.0																																								
Ø:	50.0																																													
Length:	112.0																																													
2nd:	3.0																																													
3rd:	3.0																																													
oil:	6.0																																													
16,031 cc 8 cyl 135.0 mm Bore Ø																																														
		Reference no.:	Reference no.:	Reference no.:	Reference no.:	Reference no.:																																								
		ME061782	O-Ring: 31207-62302 31207-62400 31207-62401		ME062018 ME062230	31219-34300 31219-34390 ME062310																																								
NM-Motorservice Article no./ Artikelnummer/ Modelo número/ статья номер	NM-Motorservice Article no.:	NM-Motorservice Article no.:	NM-Motorservice Article no.:	NM-Motorservice Article no.:	NM-Motorservice Article no.:	NM-Motorservice Article no.:																																								
	LBS 29300 FA	LB 29300 F (water jacket chromed)	KBS 29300 A	KB 29300 A	KR 29300	PB 29300																																								

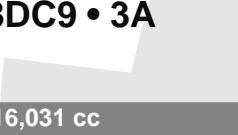
ENGINE TYPE Motortyp/ tipo de motor/ тип двигателя	LINER KIT Liner Kit/ camisas de los cilindros/ Лайнер комплект	CYL. LINER Zylinderlaufbuchse/ camisas de los cilindros/ втулка цилиндра	PISTON + RINGS Kolben + Ringe/ Pistón + Anillos/ поршень и кольца	PISTON SET Kolben Set/ Pistón Set/ поршневой	RINGS SET Ring Set/ Anillos Set/ кольца	PIN Pin/ Perno/ Пин																																								
8DC91		<table border="1"> <tr> <td></td> <td>Liner/ Sleeve</td> <td></td> </tr> <tr> <td>Length:</td> <td>260.0</td> <td></td> </tr> <tr> <td>Outside Ø:</td> <td>154.0</td> <td></td> </tr> <tr> <td>Flange Ø:</td> <td>163.0</td> <td></td> </tr> <tr> <td>Flange depth:</td> <td>11.8 +1.2</td> <td></td> </tr> </table>		Liner/ Sleeve		Length:	260.0		Outside Ø:	154.0		Flange Ø:	163.0		Flange depth:	11.8 +1.2		<table border="1"> <tr> <td></td> <td>Piston</td> <td></td> </tr> <tr> <td>Length:</td> <td>153.0</td> <td></td> </tr> <tr> <td>Comp. height:</td> <td>88.0 -12.4 -24.4</td> <td></td> </tr> </table>		Piston		Length:	153.0		Comp. height:	88.0 -12.4 -24.4			<table border="1"> <tr> <td></td> <td>Rings</td> <td></td> </tr> <tr> <td>Top:</td> <td>3.3</td> <td rowspan="4"> <table border="1"> <tr> <td>Ø:</td> <td>50.0</td> </tr> <tr> <td>Length:</td> <td>112.0</td> </tr> </table> </td> </tr> <tr> <td>2nd:</td> <td>3.0</td> </tr> <tr> <td>3rd:</td> <td>3.0</td> </tr> <tr> <td>oil:</td> <td>6.0</td> </tr> </table>		Rings		Top:	3.3	<table border="1"> <tr> <td>Ø:</td> <td>50.0</td> </tr> <tr> <td>Length:</td> <td>112.0</td> </tr> </table>	Ø:	50.0	Length:	112.0	2nd:	3.0	3rd:	3.0	oil:	6.0	
				Liner/ Sleeve																																										
Length:	260.0																																													
Outside Ø:	154.0																																													
Flange Ø:	163.0																																													
Flange depth:	11.8 +1.2																																													
	Piston																																													
Length:	153.0																																													
Comp. height:	88.0 -12.4 -24.4																																													
	Rings																																													
Top:	3.3	<table border="1"> <tr> <td>Ø:</td> <td>50.0</td> </tr> <tr> <td>Length:</td> <td>112.0</td> </tr> </table>	Ø:	50.0	Length:	112.0																																								
Ø:	50.0																																													
Length:	112.0																																													
2nd:	3.0																																													
3rd:	3.0																																													
oil:	6.0																																													
16,031 cc 8 cyl 135.0 mm Bore Ø																																														
		Reference no.:	Reference no.:	Reference no.:	Reference no.:	Reference no.:																																								
		ME061782	O-Ring: 31207-62302 31207-62400 31207-62401	ME062336	ME062018 ME062230	31219-34300 31219-34390 ME062310																																								
NM-Motorservice Article no./ Artikelnummer/ Modelo número/ статья номер	NM-Motorservice Article no.:	NM-Motorservice Article no.:	NM-Motorservice Article no.:	NM-Motorservice Article no.:	NM-Motorservice Article no.:	NM-Motorservice Article no.:																																								
	LBS 29350 FA	LB 29350 F (water jacket chromed)	KBS 29350 A	KB 29350 A	KR 29350	PB 29350																																								

ENGINE TYPE Motortyp/ tipo de motor/ тип двигателя	LINER KIT Liner Kit/ camisas de los cilindros/ Лайнер комплект	CYL. LINER Zylinderlaufbuchse/ camisas de los cilindros/ втулка цилиндра		PISTON + RINGS Kolben + Ringe/ Pistón + Anillos/ поршень и кольца		PISTON SET Kolben Set/ Pistón Set/ поршневой	RINGS SET Ring Set/ Anillos Set/ кольца		PIN Pin/ Perno/ Пин	
8DC91T		Liner/ Sleeve		Piston			Rings		Ø : Length:	50.0 112.0
		Length: Outside Ø: Flange Ø: Flange depth:	260.0 154.0 163.0 11.8 +1.2	Length: Comp. height:	153.2 88.2 -12.4 -24.3		Top: 2nd: oil:	3.3 3.0 3.0 4.0		
16,031 cc 8 cyl 135.0 mm Bore Ø		Reference no.:		Reference no.:	Reference no.:	Reference no.:	Reference no.:	Reference no.:		
		ME061782		O-Ring: 31207-62302 31207-62400 31207-62401	ME090163 ME091048	ME090578	31219-34300 31219-34390 ME062310			
NM-Motorservice Article no./ Artikelnummer/ Modelo número/ статья номер	NM-Motorservice Article no.:	NM-Motorservice Article no.:		NM-Motorservice Article no.:	NM-Motorservice Article no.:	NM-Motorservice Article no.:	NM-Motorservice Article no.:		NM-Motorservice Article no.:	
	LBS 29400 FA	LB 29400 F (water jacket chromed)		KBS 29400 A	KB 29400 A	KR 29400	PB 29400			



ENGINE TYPE Motortyp/ tipo de motor/ тип двигателя	LINER KIT Liner Kit/ camisas de los cilindros/ Лайнер комплект	CYL. LINER Zylinderlaufbuchse/ camisas de los cilindros/ втулка цилиндра		PISTON + RINGS Kolben + Ringe/ Pistón + Anillos/ поршень и кольца		PISTON SET Kolben Set/ Pistón Set/ поршневой	RINGS SET Ring Set/ Anillos Set/ кольца		PIN Pin/ Perno/ Пин	
8DC9 • 3A		Liner/ Sleeve		Piston			Rings		Ø : Length:	50.0 112.0
		Length: Outside Ø: Flange Ø: Flange depth:	259.7 154.0 163.0 11.8 +1.7	Length: Comp. height:	153.1 88.1		Top: 2nd: 3rd: oil:	3.3 3.0 3.0 4.0		
16,031 cc 8 cyl 135.0 mm Bore Ø		Reference no.:		Reference no.:	Reference no.:	Reference no.:	Reference no.:	Reference no.:		
		ME996209		ME062602 ME062603 ME062604	O-Ring: 31207-62302 31207-62400 31207-62401	ME093424	ME090578	31219-34300 31219-34390 ME062310		
NM-Motorservice Article no./ Artikelnummer/ Modelo número/ статья номер	NM-Motorservice Article no.:	NM-Motorservice Article no.:		NM-Motorservice Article no.:	NM-Motorservice Article no.:	NM-Motorservice Article no.:	NM-Motorservice Article no.:		NM-Motorservice Article no.:	
	LBS 29450 FA	LB 29450 F (water jacket chromed)		KBS 29450 A	KB 29450 A	KR 29450	PB 29450			



ENGINE TYPE Motortyp/ tipo de motor/ тип двигателя	LINER KIT Liner Kit/ camisas de los cilindros/ Лайнер комплект	CYL. LINER Zylinderlaufbuchse/ camisas de los cilindros/ втулка цилиндра		PISTON + RINGS Kolben + Ringe/ Pistón + Anillos/ поршень и кольца		PISTON SET Kolben Set/ Pistón Set/ поршневой	RINGS SET Ring Set/ Anillos Set/ кольца		PIN Pin/ Perno/ Пин	
8DC6		Liner/ Sleeve		Piston			Rings		Ø : Length:	45.0 108.0
		Length: Outside Ø: Flange Ø: Flange depth:	229.3 154.0 163.0 11.8 +1.3	Length: Comp. height:	142.8 77.8		Top: 2nd: oil:	4.0 3.0 6.0		
14,886 cc 8 cyl 135.0 mm Bore Ø		Reference no.:		Reference no.:	Reference no.:	Reference no.:	Reference no.:	Reference no.:		
		31207-63202 ME062379		O-Ring: 31207-62302 31207-62400 31207-62401	31217-78101	31217-60012 ME062086	31219-70600			
NM-Motorservice Article no./ Artikelnummer/ Modelo número/ статья номер	NM-Motorservice Article no.:	NM-Motorservice Article no.:		NM-Motorservice Article no.:	NM-Motorservice Article no.:	NM-Motorservice Article no.:	NM-Motorservice Article no.:		NM-Motorservice Article no.:	
	LBS 45250 FA	LB 45250 F		KBS 45250 A	KB 45250 A	KR 45250	PB 45250			

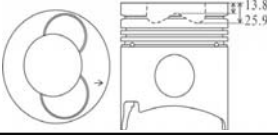

ENGINE TYPE Motortyp/ tipo de motor/ тип двигателя	LINER KIT Liner Kit/ camisas de los cilindros/ Лайнер комплект	CYL. LINER Zylinderlaufbuchse/ camisas de los cilindros/ втулка цилиндра	PISTON + RINGS Kolben + Ringe/ Pistón + Anillos/ поршень и кольца	PISTON SET Kolben Set/ Pistón Set/ поршневой	RINGS SET Ring Set/ Anillos Set/ кольца	PIN Pin/ Perno/ Пин	
8DC9 • 3AT 14,886 cc 8 cyl 135.0 mm Bore Ø		Liner/ Sleeve	Piston		Rings		
		Length: Outside Ø: Flange Ø: Flange depth:	259.7 154.0 163.0 11.8 +1.7	Length: Comp. height:	153.0 88.0	Top: 2nd: oil:	3.3 3.0 3.0 6.0
		Reference no.:	Reference no.:	Reference no.:	Reference no.:	Reference no.:	
		ME062602 ME062603 ME062604	O-Ring: 31207-62302 31207-62400 31207-62401	ME090167	ME062018 ME062230	31219-34300 31219-34390 ME062310	
NM-Motorservice Article no./ Artikelnummer/ Modelo número/ статья номер	NM-Motorservice Article no.:	NM-Motorservice Article no.:	NM-Motorservice Article no.:	NM-Motorservice Article no.:	NM-Motorservice Article no.:	NM-Motorservice Article no.:	
	LBS 29550 FA	LB 29550 F (water jacket chromed)	KBS 29550 A	KB 29550 A	KR 29550	PB 29550	

ENGINE TYPE Motortyp/ tipo de motor/ тип двигателя	LINER KIT Liner Kit/ camisas de los cilindros/ Лайнер комплект	CYL. LINER Zylinderlaufbuchse/ camisas de los cilindros/ втулка цилиндра	PISTON + RINGS Kolben + Ringe/ Pistón + Anillos/ поршень и кольца	PISTON SET Kolben Set/ Pistón Set/ поршневой	RINGS SET Ring Set/ Anillos Set/ кольца	PIN Pin/ Perno/ Пин	
8DC91 • 3AT 16,031 cc 8 cyl 135.0 mm Bore Ø		Liner/ Sleeve	Piston		Rings		
		Length: Outside Ø: Flange Ø: Flange depth:	259.7 154.0 163.0 11.8 +1.7	Length: Comp. height:	153.1 88.1	Top: 2nd: 3rd: oil:	3.3 3.0 3.0 4.0
		Reference no.:	Reference no.:	Reference no.:	Reference no.:	Reference no.:	
		ME062602 ME062603 ME062604	O-Ring: 31207-62302 31207-62400 31207-62401	ME092922	ME090578	31219-34300 31219-34390 ME062310	
NM-Motorservice Article no./ Artikelnummer/ Modelo número/ статья номер	NM-Motorservice Article no.:	NM-Motorservice Article no.:	NM-Motorservice Article no.:	NM-Motorservice Article no.:	NM-Motorservice Article no.:	NM-Motorservice Article no.:	
	LBS 29600 BFA	LB 29600 F (water jacket chromed)	KBS 29600 BA	KB 29600 BA	KR 29600	PB 29600	

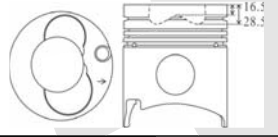
ENGINE TYPE Motortyp/ tipo de motor/ тип двигателя	LINER KIT Liner Kit/ camisas de los cilindros/ Лайнер комплект	CYL. LINER Zylinderlaufbuchse/ camisas de los cilindros/ втулка цилиндра	PISTON + RINGS Kolben + Ringe/ Pistón + Anillos/ поршень и кольца	PISTON SET Kolben Set/ Pistón Set/ поршневой	RINGS SET Ring Set/ Anillos Set/ кольца	PIN Pin/ Perno/ Пин	
8DC82 14,886 cc 8 cyl 135.0 mm Bore Ø		Liner/ Sleeve	Piston		Rings		
		Length: Outside Ø: Flange Ø: Flange depth:	229.3 154.0 163.0 11.8 +1.0	Length: Comp. height:	143.1 78.1 -12.3 -23.6	Top: 2nd: oil:	3.3 3.0 6.0
		Reference no.:	Reference no.:	Reference no.:	Reference no.:	Reference no.:	
		31207-72183	O-Ring: 31207-62302 31207-62400 31207-62401	ME062589	ME062022 ME062246 ME065684	31219-70600	
NM-Motorservice Article no./ Artikelnummer/ Modelo número/ статья номер	NM-Motorservice Article no.:	NM-Motorservice Article no.:	NM-Motorservice Article no.:	NM-Motorservice Article no.:	NM-Motorservice Article no.:	NM-Motorservice Article no.:	
	LBS 29650 FA	LB 29650 F (water jacket chromed)	KBS 29650 CA	KB 29650 CA	KR 29650	PB 29650	

ENGINE TYPE Motortyp/ tipo de motor/ тип двигателя	LINER KIT Liner Kit/ camisas de los cilindros/ Лайнер комплект	CYL. LINER Zylinderlaufbuchse/ camisas de los cilindros/ втулка цилиндра	PISTON + RINGS Kolben + Ringe/ Pistón + Anillos/ поршень и кольца	PISTON SET Kolben Set/ Pistón Set/ поршневой	RINGS SET Ring Set/ Anillos Set/ кольца	PIN Pin/ Perno/ Пин																																								
8DC9T2		<table border="1"> <tr> <td></td> <td>Liner/ Sleeve</td> <td></td> </tr> <tr> <td>Length:</td> <td>259.7</td> <td></td> </tr> <tr> <td>Outside Ø:</td> <td>154.0</td> <td></td> </tr> <tr> <td>Flange Ø:</td> <td>163.0</td> <td></td> </tr> <tr> <td>Flange depth:</td> <td>11.8 +1.7</td> <td></td> </tr> </table>		Liner/ Sleeve		Length:	259.7		Outside Ø:	154.0		Flange Ø:	163.0		Flange depth:	11.8 +1.7		<table border="1"> <tr> <td></td> <td>Piston</td> <td></td> </tr> <tr> <td>Length:</td> <td>153.0</td> <td></td> </tr> <tr> <td>Comp. height:</td> <td>88.0 -13.8 -25.9</td> <td></td> </tr> </table>		Piston		Length:	153.0		Comp. height:	88.0 -13.8 -25.9			<table border="1"> <tr> <td></td> <td>Rings</td> <td></td> </tr> <tr> <td>Top:</td> <td>3.3</td> <td rowspan="5"> <table border="1"> <tr> <td>Ø:</td> <td>50.0</td> </tr> <tr> <td>Length:</td> <td>112.0</td> </tr> </table> </td> </tr> <tr> <td>2nd:</td> <td>3.0</td> </tr> <tr> <td>3rd:</td> <td>3.0</td> </tr> <tr> <td>oil:</td> <td>4.0</td> </tr> </table>		Rings		Top:	3.3	<table border="1"> <tr> <td>Ø:</td> <td>50.0</td> </tr> <tr> <td>Length:</td> <td>112.0</td> </tr> </table>	Ø:	50.0	Length:	112.0	2nd:	3.0	3rd:	3.0	oil:	4.0	
				Liner/ Sleeve																																										
Length:	259.7																																													
Outside Ø:	154.0																																													
Flange Ø:	163.0																																													
Flange depth:	11.8 +1.7																																													
	Piston																																													
Length:	153.0																																													
Comp. height:	88.0 -13.8 -25.9																																													
	Rings																																													
Top:	3.3	<table border="1"> <tr> <td>Ø:</td> <td>50.0</td> </tr> <tr> <td>Length:</td> <td>112.0</td> </tr> </table>	Ø:	50.0	Length:	112.0																																								
Ø:	50.0																																													
Length:	112.0																																													
2nd:	3.0																																													
3rd:	3.0																																													
oil:	4.0																																													
Reference no.:	Reference no.:	Reference no.:	Reference no.:	Reference no.:																																										
																																														
NM-Motorservice Article no./ Artikelnummer/ Modelo número/ статья номер	NM-Motorservice Article no.:	NM-Motorservice Article no.:	NM-Motorservice Article no.:	NM-Motorservice Article no.:	NM-Motorservice Article no.:	NM-Motorservice Article no.:																																								
	LBS 29700 FA	LB 29700 F (water jacket chromed)	KBS 29700 A	KB 29700 A	KR 29700	PB 29700																																								

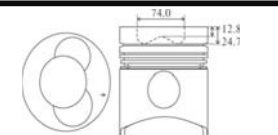

ENGINE TYPE Motortyp/ tipo de motor/ тип двигателя	LINER KIT Liner Kit/ camisas de los cilindros/ Лайнер комплект	CYL. LINER Zylinderlaufbuchse/ camisas de los cilindros/ втулка цилиндра	PISTON + RINGS Kolben + Ringe/ Pistón + Anillos/ поршень и кольца	PISTON SET Kolben Set/ Pistón Set/ поршневой	RINGS SET Ring Set/ Anillos Set/ кольца	PIN Pin/ Perno/ Пин																																								
8DC9T2 • 3V		<table border="1"> <tr> <td></td> <td>Liner/ Sleeve</td> <td></td> </tr> <tr> <td>Length:</td> <td>259.7</td> <td></td> </tr> <tr> <td>Outside Ø:</td> <td>154.0</td> <td></td> </tr> <tr> <td>Flange Ø:</td> <td>163.0</td> <td></td> </tr> <tr> <td>Flange depth:</td> <td>11.8 +1.7</td> <td></td> </tr> </table>		Liner/ Sleeve		Length:	259.7		Outside Ø:	154.0		Flange Ø:	163.0		Flange depth:	11.8 +1.7		<table border="1"> <tr> <td></td> <td>Piston</td> <td></td> </tr> <tr> <td>Length:</td> <td>153.0</td> <td></td> </tr> <tr> <td>Comp. height:</td> <td>88.0 -16.5 -28.5</td> <td></td> </tr> </table>		Piston		Length:	153.0		Comp. height:	88.0 -16.5 -28.5			<table border="1"> <tr> <td></td> <td>Rings</td> <td></td> </tr> <tr> <td>Top:</td> <td>3.3</td> <td rowspan="5"> <table border="1"> <tr> <td>Ø:</td> <td>50.0</td> </tr> <tr> <td>Length:</td> <td>112.0</td> </tr> </table> </td> </tr> <tr> <td>2nd:</td> <td>3.0</td> </tr> <tr> <td>3rd:</td> <td>3.0</td> </tr> <tr> <td>oil:</td> <td>4.0</td> </tr> </table>		Rings		Top:	3.3	<table border="1"> <tr> <td>Ø:</td> <td>50.0</td> </tr> <tr> <td>Length:</td> <td>112.0</td> </tr> </table>	Ø:	50.0	Length:	112.0	2nd:	3.0	3rd:	3.0	oil:	4.0	
				Liner/ Sleeve																																										
Length:	259.7																																													
Outside Ø:	154.0																																													
Flange Ø:	163.0																																													
Flange depth:	11.8 +1.7																																													
	Piston																																													
Length:	153.0																																													
Comp. height:	88.0 -16.5 -28.5																																													
	Rings																																													
Top:	3.3	<table border="1"> <tr> <td>Ø:</td> <td>50.0</td> </tr> <tr> <td>Length:</td> <td>112.0</td> </tr> </table>	Ø:	50.0	Length:	112.0																																								
Ø:	50.0																																													
Length:	112.0																																													
2nd:	3.0																																													
3rd:	3.0																																													
oil:	4.0																																													
Reference no.:	Reference no.:	Reference no.:	Reference no.:	Reference no.:																																										
																																														
NM-Motorservice Article no./ Artikelnummer/ Modelo número/ статья номер	NM-Motorservice Article no.:	NM-Motorservice Article no.:	NM-Motorservice Article no.:	NM-Motorservice Article no.:	NM-Motorservice Article no.:	NM-Motorservice Article no.:																																								
	LBS 29750 FA	LB 29750 F (water jacket chromed)	KBS 29750 A	KB 29750 A	KR 29750	PB 29750																																								



ENGINE TYPE Motortyp/ tipo de motor/ тип двигателя	LINER KIT Liner Kit/ camisas de los cilindros/ Лайнер комплект	CYL. LINER Zylinderlaufbuchse/ camisas de los cilindros/ втулка цилиндра	PISTON + RINGS Kolben + Ringe/ Pistón + Anillos/ поршень и кольца	PISTON SET Kolben Set/ Pistón Set/ поршневой	RINGS SET Ring Set/ Anillos Set/ кольца	PIN Pin/ Perno/ Пин																																								
8DC10		<table border="1"> <tr> <td></td> <td>Liner/ Sleeve</td> <td></td> </tr> <tr> <td>Length:</td> <td>259.7</td> <td></td> </tr> <tr> <td>Outside Ø:</td> <td>154.0</td> <td></td> </tr> <tr> <td>Flange Ø:</td> <td>163.0</td> <td></td> </tr> <tr> <td>Flange depth:</td> <td>11.8 +1.7</td> <td></td> </tr> </table>		Liner/ Sleeve		Length:	259.7		Outside Ø:	154.0		Flange Ø:	163.0		Flange depth:	11.8 +1.7		<table border="1"> <tr> <td></td> <td>Piston</td> <td></td> </tr> <tr> <td>Length:</td> <td>153.1</td> <td></td> </tr> <tr> <td>Comp. height:</td> <td>88.1 -12.8 -24.7</td> <td></td> </tr> </table>		Piston		Length:	153.1		Comp. height:	88.1 -12.8 -24.7			<table border="1"> <tr> <td></td> <td>Rings</td> <td></td> </tr> <tr> <td>Top:</td> <td>3.3</td> <td rowspan="5"> <table border="1"> <tr> <td>Ø:</td> <td>50.0</td> </tr> <tr> <td>Length:</td> <td>112.0</td> </tr> </table> </td> </tr> <tr> <td>2nd:</td> <td>3.0</td> </tr> <tr> <td>3rd:</td> <td>3.0</td> </tr> <tr> <td>oil:</td> <td>4.0</td> </tr> </table>		Rings		Top:	3.3	<table border="1"> <tr> <td>Ø:</td> <td>50.0</td> </tr> <tr> <td>Length:</td> <td>112.0</td> </tr> </table>	Ø:	50.0	Length:	112.0	2nd:	3.0	3rd:	3.0	oil:	4.0	
				Liner/ Sleeve																																										
Length:	259.7																																													
Outside Ø:	154.0																																													
Flange Ø:	163.0																																													
Flange depth:	11.8 +1.7																																													
	Piston																																													
Length:	153.1																																													
Comp. height:	88.1 -12.8 -24.7																																													
	Rings																																													
Top:	3.3	<table border="1"> <tr> <td>Ø:</td> <td>50.0</td> </tr> <tr> <td>Length:</td> <td>112.0</td> </tr> </table>	Ø:	50.0	Length:	112.0																																								
Ø:	50.0																																													
Length:	112.0																																													
2nd:	3.0																																													
3rd:	3.0																																													
oil:	4.0																																													
Reference no.:	Reference no.:	Reference no.:	Reference no.:	Reference no.:																																										
																																														
NM-Motorservice Article no./ Artikelnummer/ Modelo número/ статья номер	NM-Motorservice Article no.:	NM-Motorservice Article no.:	NM-Motorservice Article no.:	NM-Motorservice Article no.:	NM-Motorservice Article no.:	NM-Motorservice Article no.:																																								
	LBS 29800 FA	LB 29800 F (water jacket chromed)	KBS 29800 A	KB 29800 A	KR 29800	PB 29800																																								

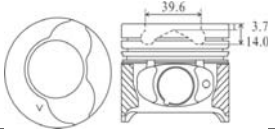

ENGINE TYPE Motortyp/ tipo de motor/ тип двигателя	LINER KIT Liner Kit/ camisas de los cilindros/ Лайнер комплект	CYL. LINER Zylinderlaufbuche/ camisas de los cilindros/ втулка цилиндра	PISTON + RINGS Kolben + Ringe/ Pistón + Anillos/ поршень и кольца	PISTON SET Kolben Set/ Pistón Set/ поршневой	RINGS SET Ring Set/ Anillos Set/ кольца	PIN Pin/ Perno/ Пин	
8DC10 17,739 cc 8 cyl 138.0 mm Bore Ø		Liner/ Sleeve	Piston		Rings		
		Length: Outside Ø: Flange Ø: Flange depth:	259.7 154.0 163.0 11.8 +1.7	Length: Comp. height:	153.1 88.1 -12.9 -24.8	Top: 2nd: 3rd: oil:	3.3 3.0 3.0 4.0
		Reference no.:	Reference no.:	Reference no.:	Reference no.:	Reference no.:	
		ME062783	O-Ring: 31207-62302 31207-62400 31207-62401	ME091049	ME090582 ME997030	31219-34300 31219-34390 ME062310	
NM-Motorservice Article no./ Artikelnummer/ Modelo número/ статья номер	NM-Motorservice Article no.:	NM-Motorservice Article no.:	NM-Motorservice Article no.:	NM-Motorservice Article no.:	NM-Motorservice Article no.:	NM-Motorservice Article no.:	
	LBS 29850 FA	LB 29850 F (water jacket chromed)	KBS 29850 A	KB 29850 A	KR 29850	PB 29850	

ENGINE TYPE Motortyp/ tipo de motor/ тип двигателя	LINER KIT Liner Kit/ camisas de los cilindros/ Лайнер комплект	CYL. LINER Zylinderlaufbuche/ camisas de los cilindros/ втулка цилиндра	PISTON + RINGS Kolben + Ringe/ Pistón + Anillos/ поршень и кольца	PISTON SET Kolben Set/ Pistón Set/ поршневой	RINGS SET Ring Set/ Anillos Set/ кольца	PIN Pin/ Perno/ Пин	
8DC11 16,752 cc 8 cyl 142.0 mm Bore Ø		Liner/ Sleeve	Piston		Rings		
		Length: Outside Ø: Flange Ø: Flange depth:	259.5 154.0 163.0 201.3 +1.7	Length: Comp. height:	153.1 88.1 -13.1 -25.3	Top: 2nd: 3rd: oil:	3.3 3.0 3.0 4.0
		Reference no.:	Reference no.:	Reference no.:	Reference no.:	Reference no.:	
		ME060439 ME060440 ME060441	O-Ring: ME035606 ME035614	ME091050	30617-50111 ME090586 ME999990	31219-34300 31219-34390 ME062310	
NM-Motorservice Article no./ Artikelnummer/ Modelo número/ статья номер	NM-Motorservice Article no.:	NM-Motorservice Article no.:	NM-Motorservice Article no.:	NM-Motorservice Article no.:	NM-Motorservice Article no.:	NM-Motorservice Article no.:	
	LBS 29900 FA	LB 29900 F (phosphating and water jacket chromed)	KBS 29900 A	KB 29900 A	KR 29900	PB 29900	

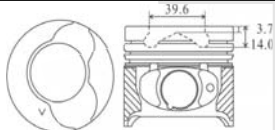
ENGINE TYPE Motortyp/ tipo de motor/ тип двигателя	LINER KIT Liner Kit/ camisas de los cilindros/ Лайнер комплект	CYL. LINER Zylinderlaufbuche/ camisas de los cilindros/ втулка цилиндра	PISTON + RINGS Kolben + Ringe/ Pistón + Anillos/ поршень и кольца	PISTON SET Kolben Set/ Pistón Set/ поршневой	RINGS SET Ring Set/ Anillos Set/ кольца	PIN Pin/ Perno/ Пин	
8M20 20,089 cc 8 cyl 146.0 mm Bore Ø		Liner/ Sleeve	Piston		Rings		
		Length: Outside Ø: Flange Ø: Flange depth:	258.2 158.0 177.5 12.0 +2.0	Length: Comp. height:	147.7 82.7 -9.4 -24.8	Top: 2nd: 3rd: oil:	3.3 3.0 3.0 4.0
		Reference no.:	Reference no.:	Reference no.:	Reference no.:	Reference no.:	
		ME997879	ME161018	O-Ring: ME020855	ME160286	ME996163	ME062310 31219-34300 31219-34390
NM-Motorservice Article no./ Artikelnummer/ Modelo número/ статья номер	NM-Motorservice Article no.:	NM-Motorservice Article no.:	NM-Motorservice Article no.:	NM-Motorservice Article no.:	NM-Motorservice Article no.:	NM-Motorservice Article no.:	
	LBS 29950 FA	LB 29950 F (water jacket chromed)	KBS 29950 A	KB 29950 A	KR 29950	PB 29950	

ENGINE TYPE Motortyp/ tipo de motor/ тип двигателя	LINER KIT Liner Kit/ camisas de los cilindros/ Лайнер комплект	CYL. LINER Zylinderlaufbuchse/ camisas de los cilindros/ втулка цилиндра	PISTON + RINGS Kolben + Ringe/ Pistón + Anillos/ поршень и кольца	PISTON SET Kolben Set/ Pistón Set/ поршневой	RINGS SET Ring Set/ Anillos Set/ кольца	PIN Pin/ Perno/ Пин																																					
K9K 700/704 K9K 722/750 ALMERA KUBISTAR MICRA 1.5 DCI (K12E N16E) 2003-2005 1,461 cc 4 cyl 76.0 mm Bore Ø		<table border="1"> <tr> <td></td> <td>Flanged</td> <td>No flange</td> </tr> <tr> <td>Length:</td> <td>145.0</td> <td>140.0</td> </tr> <tr> <td>Outside Ø:</td> <td>80.5</td> <td>80.5</td> </tr> <tr> <td>Flange Ø:</td> <td>84.5</td> <td></td> </tr> <tr> <td>Flange depth:</td> <td>5.0</td> <td></td> </tr> </table>		Flanged	No flange	Length:	145.0	140.0	Outside Ø:	80.5	80.5	Flange Ø:	84.5		Flange depth:	5.0		<table border="1"> <tr> <td colspan="2">Piston</td> </tr> <tr> <td>Length:</td> <td>66.0</td> </tr> <tr> <td>Comp. height:</td> <td>41.78</td> </tr> <tr> <td></td> <td>-3.7</td> </tr> <tr> <td></td> <td>-14.0</td> </tr> </table>	Piston		Length:	66.0	Comp. height:	41.78		-3.7		-14.0	Alfin skirt MOS2 treated	<table border="1"> <tr> <td colspan="2">Rings</td> </tr> <tr> <td>Top:</td> <td>2.0</td> </tr> <tr> <td>2nd:</td> <td>2.0</td> </tr> <tr> <td>oil:</td> <td>2.5</td> </tr> </table>	Rings		Top:	2.0	2nd:	2.0	oil:	2.5	<table border="1"> <tr> <td>Ø:</td> <td>25.0</td> </tr> <tr> <td>Length:</td> <td>60.0</td> </tr> </table>	Ø:	25.0	Length:	60.0
			Flanged	No flange																																							
		Length:	145.0	140.0																																							
Outside Ø:	80.5	80.5																																									
Flange Ø:	84.5																																										
Flange depth:	5.0																																										
Piston																																											
Length:	66.0																																										
Comp. height:	41.78																																										
	-3.7																																										
	-14.0																																										
Rings																																											
Top:	2.0																																										
2nd:	2.0																																										
oil:	2.5																																										
Ø:	25.0																																										
Length:	60.0																																										
LB 29100-2 S:		Reference no.:		Reference no.:	Reference no.:	Reference no.:																																					
<table border="1"> <tr> <td></td> <td>Flanged</td> <td></td> </tr> <tr> <td>Length:</td> <td>143.5</td> <td></td> </tr> <tr> <td>Outside Ø:</td> <td>79.5</td> <td></td> </tr> <tr> <td>Flange Ø:</td> <td>81.5</td> <td></td> </tr> <tr> <td>Flange depth:</td> <td>4.0</td> <td></td> </tr> </table>			Flanged		Length:	143.5		Outside Ø:	79.5		Flange Ø:	81.5		Flange depth:	4.0		<table border="1"> <tr> <td colspan="2">Reference no.:</td> </tr> <tr> <td colspan="2">12010-AY601</td> </tr> <tr> <td colspan="2">12010-AY602</td> </tr> <tr> <td colspan="2">12010-BN700</td> </tr> <tr> <td colspan="2">12010-BN701</td> </tr> <tr> <td colspan="2">12010-BN702</td> </tr> </table>		Reference no.:		12010-AY601		12010-AY602		12010-BN700		12010-BN701		12010-BN702		Reference no.:	Reference no.:	Reference no.:										
	Flanged																																										
Length:	143.5																																										
Outside Ø:	79.5																																										
Flange Ø:	81.5																																										
Flange depth:	4.0																																										
Reference no.:																																											
12010-AY601																																											
12010-AY602																																											
12010-BN700																																											
12010-BN701																																											
12010-BN702																																											
NM-Motorservice Article no./ Artikelnummer/ Modelo número/ статья номер	NM-Motorservice Article no.:	NM-Motorservice Article no.:	NM-Motorservice Article no.:	NM-Motorservice Article no.:	NM-Motorservice Article no.:	NM-Motorservice Article no.:																																					
	LBS 43000 PA LBS 43000 SA	LB 43000 P LB 43000 S LB 43000-2 S	KBS 43000 A	KB 43000 A	KR 43000	PB 43000																																					

ENGINE TYPE Motortyp/ tipo de motor/ тип двигателя	LINER KIT Liner Kit/ camisas de los cilindros/ Лайнер комплект	CYL. LINER Zylinderlaufbuchse/ camisas de los cilindros/ втулка цилиндра	PISTON + RINGS Kolben + Ringe/ Pistón + Anillos/ поршень и кольца	PISTON SET Kolben Set/ Pistón Set/ поршневой	RINGS SET Ring Set/ Anillos Set/ кольца	PIN Pin/ Perno/ Пин																																					
K9K 700/704 K9K 722/750 ALMERA KUBISTAR MICRA NOTE 1.5 DCI / (E11E K12E N16E X70) 2002- 1,461 cc 4 cyl 76.0 mm Bore Ø		<table border="1"> <tr> <td></td> <td>Flanged</td> <td>No flange</td> </tr> <tr> <td>Length:</td> <td>145.0</td> <td>140.0</td> </tr> <tr> <td>Outside Ø:</td> <td>80.5</td> <td>80.5</td> </tr> <tr> <td>Flange Ø:</td> <td>84.5</td> <td></td> </tr> <tr> <td>Flange depth:</td> <td>5.0</td> <td></td> </tr> </table>		Flanged	No flange	Length:	145.0	140.0	Outside Ø:	80.5	80.5	Flange Ø:	84.5		Flange depth:	5.0		<table border="1"> <tr> <td colspan="2">Piston</td> </tr> <tr> <td>Length:</td> <td>66.0</td> </tr> <tr> <td>Comp. height:</td> <td>41.78</td> </tr> <tr> <td></td> <td>-3.7</td> </tr> <tr> <td></td> <td>-14.0</td> </tr> </table>	Piston		Length:	66.0	Comp. height:	41.78		-3.7		-14.0	Alfin skirt MOS2 treated	<table border="1"> <tr> <td colspan="2">Rings</td> </tr> <tr> <td>Top:</td> <td>2.0</td> </tr> <tr> <td>2nd:</td> <td>2.0</td> </tr> <tr> <td>oil:</td> <td>2.5</td> </tr> </table>	Rings		Top:	2.0	2nd:	2.0	oil:	2.5	<table border="1"> <tr> <td>Ø:</td> <td>26.0</td> </tr> <tr> <td>Length:</td> <td>60.0</td> </tr> </table>	Ø:	26.0	Length:	60.0
			Flanged	No flange																																							
		Length:	145.0	140.0																																							
Outside Ø:	80.5	80.5																																									
Flange Ø:	84.5																																										
Flange depth:	5.0																																										
Piston																																											
Length:	66.0																																										
Comp. height:	41.78																																										
	-3.7																																										
	-14.0																																										
Rings																																											
Top:	2.0																																										
2nd:	2.0																																										
oil:	2.5																																										
Ø:	26.0																																										
Length:	60.0																																										
LB 25300-2 S:		Reference no.:		Reference no.:	Reference no.:	Reference no.:																																					
<table border="1"> <tr> <td></td> <td>Flanged</td> <td></td> </tr> <tr> <td>Length:</td> <td>143.5</td> <td></td> </tr> <tr> <td>Outside Ø:</td> <td>79.5</td> <td></td> </tr> <tr> <td>Flange Ø:</td> <td>81.5</td> <td></td> </tr> <tr> <td>Flange depth:</td> <td>4.0</td> <td></td> </tr> </table>			Flanged		Length:	143.5		Outside Ø:	79.5		Flange Ø:	81.5		Flange depth:	4.0		<table border="1"> <tr> <td colspan="2">Reference no.:</td> </tr> <tr> <td colspan="2">12010-00QAP</td> </tr> <tr> <td colspan="2">12010-00QAR</td> </tr> <tr> <td colspan="2">12010-00QAS</td> </tr> <tr> <td colspan="2">12010-00QAW</td> </tr> </table>		Reference no.:		12010-00QAP		12010-00QAR		12010-00QAS		12010-00QAW		Reference no.:	Reference no.:	Reference no.:												
	Flanged																																										
Length:	143.5																																										
Outside Ø:	79.5																																										
Flange Ø:	81.5																																										
Flange depth:	4.0																																										
Reference no.:																																											
12010-00QAP																																											
12010-00QAR																																											
12010-00QAS																																											
12010-00QAW																																											
NM-Motorservice Article no./ Artikelnummer/ Modelo número/ статья номер	NM-Motorservice Article no.:	NM-Motorservice Article no.:	NM-Motorservice Article no.:	NM-Motorservice Article no.:	NM-Motorservice Article no.:	NM-Motorservice Article no.:																																					
	LBS 43050 PA LBS 43050 SA	LB 43050 P LB 43050 S LB 43050-2 S	KBS 43050 A	KB 43050 A	KR 43050	PB 43050																																					

ENGINE TYPE Motortyp/ tipo de motor/ тип двигателя	LINER KIT Liner Kit/ camisas de los cilindros/ Лайнер комплект	CYL. LINER Zylinderlaufbuchse/ camisas de los cilindros/ втулка цилиндра	PISTON + RINGS Kolben + Ringe/ Pistón + Anillos/ поршень и кольца	PISTON SET Kolben Set/ Pistón Set/ поршневой	RINGS SET Ring Set/ Anillos Set/ кольца	PIN Pin/ Perno/ Пин																																					
TD15 MICRA 1.5 D (K11E) 1989- cc cyl mm Bore Ø		<table border="1"> <tr> <td></td> <td>Flanged</td> <td>No flange</td> </tr> <tr> <td>Length:</td> <td>147.5</td> <td>142.5</td> </tr> <tr> <td>Outside Ø:</td> <td>81.0</td> <td>81.0</td> </tr> <tr> <td>Flange Ø:</td> <td>84.0</td> <td></td> </tr> <tr> <td>Flange depth:</td> <td>5.0</td> <td></td> </tr> </table>		Flanged	No flange	Length:	147.5	142.5	Outside Ø:	81.0	81.0	Flange Ø:	84.0		Flange depth:	5.0		<table border="1"> <tr> <td colspan="2">Piston</td> </tr> <tr> <td>Length:</td> <td>66.32</td> </tr> <tr> <td>Comp. height:</td> <td>40.37</td> </tr> <tr> <td></td> <td>-1.5</td> </tr> <tr> <td></td> <td>-2.4</td> </tr> </table>	Piston		Length:	66.32	Comp. height:	40.37		-1.5		-2.4	Alfin skirt MOS2 treated	<table border="1"> <tr> <td colspan="2">Rings</td> </tr> <tr> <td>Top:</td> <td>2.0</td> </tr> <tr> <td>2nd:</td> <td>1.75</td> </tr> <tr> <td>oil:</td> <td>3.0</td> </tr> </table>	Rings		Top:	2.0	2nd:	1.75	oil:	3.0	<table border="1"> <tr> <td>Ø:</td> <td>23.0</td> </tr> <tr> <td>Length:</td> <td>60.0</td> </tr> </table>	Ø:	23.0	Length:	60.0
			Flanged	No flange																																							
		Length:	147.5	142.5																																							
Outside Ø:	81.0	81.0																																									
Flange Ø:	84.0																																										
Flange depth:	5.0																																										
Piston																																											
Length:	66.32																																										
Comp. height:	40.37																																										
	-1.5																																										
	-2.4																																										
Rings																																											
Top:	2.0																																										
2nd:	1.75																																										
oil:	3.0																																										
Ø:	23.0																																										
Length:	60.0																																										
Reference no.:		Reference no.:		Reference no.:	Reference no.:	Reference no.:																																					
<table border="1"> <tr> <td colspan="2">Reference no.:</td> </tr> <tr> <td colspan="2">12010-6F910</td> </tr> <tr> <td colspan="2">12010-6F911</td> </tr> <tr> <td colspan="2">12010-6F912</td> </tr> </table>		Reference no.:		12010-6F910		12010-6F911		12010-6F912		<table border="1"> <tr> <td colspan="2">Reference no.:</td> </tr> <tr> <td colspan="2">12010-6F910</td> </tr> <tr> <td colspan="2">12010-6F911</td> </tr> <tr> <td colspan="2">12010-6F912</td> </tr> </table>		Reference no.:		12010-6F910		12010-6F911		12010-6F912		Reference no.:	Reference no.:	Reference no.:																					
Reference no.:																																											
12010-6F910																																											
12010-6F911																																											
12010-6F912																																											
Reference no.:																																											
12010-6F910																																											
12010-6F911																																											
12010-6F912																																											
NM-Motorservice Article no./ Artikelnummer/ Modelo número/ статья номер	NM-Motorservice Article no.:	NM-Motorservice Article no.:	NM-Motorservice Article no.:	NM-Motorservice Article no.:	NM-Motorservice Article no.:	NM-Motorservice Article no.:																																					
	LBS 43100 P LBS 43100 S	LB 43100 P LB 43100 S	KBS 43100	KB 43100	KR 43100	PB 43100																																					

ENGINE TYPE Motortyp/ tipo de motor/ тип двигателя	LINER KIT Liner Kit/ camisas de los cilindros/ Лайнер комплект	CYL. LINER Zylinderlaufbuchse/ camisas de los cilindros/ втулка цилиндра		PISTON + RINGS Kolben + Ringe/ Pistón + Anillos/ поршень и кольца		PISTON SET Kolben Set/ Pistón Set/ поршневой	RINGS SET Ring Set/ Anillos Set/ кольца	PIN Pin/ Perno/ Пин	
CD17 CHERRY SUNNY (B11 B12 N12 N13 Y10) 1982-1998 1,680 cc 4 cyl 80.0 mm Bore Ø			Flanged	No flange	Piston		Rings		
		Length:	146.0	146.0	Length:	71.0	Top:	1.75	Ø : 24.0 Length: 63.0
		Outside Ø:	84.0	84.0	Comp. height:	41.0	2nd:	2.0	
Flange Ø:	86.0		Flange depth:	4.8		oil:	3.0	Reference no.:	
		Reference no.:		Reference no.:		Reference no.:		Reference no.:	
		11012-16A00				12010-6A02/4/6 12010-7A02/4/6 12010-71A02/4/6		12033-16A00 12033-16A10 12036-16A00 12036-16A10 12038-16A00 12038-16A10	12030-16A00 12030-16A01 12030-16A02
NM-Motorservice Article no./ Artikelnummer/ Modelo нúmero/ статья номер	NM-Motorservice Article no.:	NM-Motorservice Article no.:		NM-Motorservice Article no.:		NM-Motorservice Article no.:	NM-Motorservice Article no.:	NM-Motorservice Article no.:	
	LBS 43150 PA LBS 43150 SA	LB 43150 P LB 43150 S		KBS 43150 A		KB 43150 A	KR 43150	PB 43150	

ENGINE TYPE Motortyp/ tipo de motor/ тип двигателя	LINER KIT Liner Kit/ camisas de los cilindros/ Лайнер комплект	CYL. LINER Zylinderlaufbuchse/ camisas de los cilindros/ втулка цилиндра		PISTON + RINGS Kolben + Ringe/ Pistón + Anillos/ поршень и кольца		PISTON SET Kolben Set/ Pistón Set/ поршневой	RINGS SET Ring Set/ Anillos Set/ кольца	PIN Pin/ Perno/ Пин		
F9Q 780 PRIMASTAR INTERSTAR 1.9 DTI (X70 X83) 2002- 1,870 cc 4 cyl 80.0 mm Bore Ø			Flanged	No flange	Piston		Rings			
		Length:	154.0	154.0	Length:	77.4	Alfin skirt MOS2 treated	Top:	2.5	Ø : 28.0 Length: 60.0
		Outside Ø:	83.05	83.05	Comp. height:	47.06		2nd:	2.0	
Flange Ø:	86.0		Flange depth:	5.0		oil:	3.0	Reference no.:		
		Reference no.:		Reference no.:		Reference no.:		Reference no.:		
				12010-00QAD 12010-00QAE 12010-00QAF		12033-AW300 A2033-00QAA				
NM-Motorservice Article no./ Artikelnummer/ Modelo нúmero/ статья номер	NM-Motorservice Article no.:	NM-Motorservice Article no.:		NM-Motorservice Article no.:		NM-Motorservice Article no.:	NM-Motorservice Article no.:	NM-Motorservice Article no.:		
	LBS 43200 PA LBS 43200 SA	LB 43200 P LB 43200 S		KBS 43200 A		KB 43200 A	KR 43200	PB 43200		

ENGINE TYPE Motortyp/ tipo de motor/ тип двигателя	LINER KIT Liner Kit/ camisas de los cilindros/ Лайнер комплект	CYL. LINER Zylinderlaufbuchse/ camisas de los cilindros/ втулка цилиндра		PISTON + RINGS Kolben + Ringe/ Pistón + Anillos/ поршень и кольца		PISTON SET Kolben Set/ Pistón Set/ поршневой	RINGS SET Ring Set/ Anillos Set/ кольца	PIN Pin/ Perno/ Пин		
F9Q 800 PRIMERA 1.9 DCI (P12E) 2003- 1,870 cc 4 cyl 80.0 mm Bore Ø			Flanged	No flange	Piston		Rings			
		Length:	154.0	154.0	Length:	77.0	Alfin and with oil gallery skirt MOS2 treated	Top:	2.5	Ø : 28.0 Length: 60.0
		Outside Ø:	83.05	83.05	Comp. height:	47.04		2nd:	2.0	
Flange Ø:	86.0		Flange depth:	5.0		oil:	3.0	Reference no.:		
		Reference no.:		Reference no.:		Reference no.:		Reference no.:		
				12010-AW303 12010-AW304 12010-AW305		12033-AW300 A2033-00QAA				
NM-Motorservice Article no./ Artikelnummer/ Modelo нúmero/ статья номер	NM-Motorservice Article no.:	NM-Motorservice Article no.:		NM-Motorservice Article no.:		NM-Motorservice Article no.:	NM-Motorservice Article no.:	NM-Motorservice Article no.:		
	LBS 43250 PB LBS 43250 SB	LB 43250 P LB 43250 S		KBS 43250 B		KB 43250 B	KR 43250	PB 43250		

ENGINE TYPE Motortyp/ tipo de motor/ тип двигателя	LINER KIT Liner Kit/ camisas de los cilindros/ Лайнер комплект	CYL. LINER Zylinderlaufbuchse/ camisas de los cilindros/ втулка цилиндра		PISTON + RINGS Kolben + Ringe/ Pistón + Anillos/ поршень и кольца		PISTON SET Kolben Set/ Pistón Set/ поршневой	RINGS SET Ring Set/ Anillos Set/ кольца	PIN Pin/ Perno/ Пин	
R9M QASHQAI (J10E) QASHQAI +2 (JJ10E) 1,598 cc 4 cyl 80.0 mm Bore Ø			Liner/ Sleeve	Piston		Alfin and with oil gallery	Rings		Ø: Length:
		Length: Outside Ø: Flange Ø: Flange depth:		Length: Comp. height:			Top: 2nd: oil:		
		Reference no.:		Reference no.:		Reference no.:	Reference no.:		Reference no.:
NM-Motorservice Article no./ Artikelnummer/ Modelo número/ статья номер	NM-Motorservice Article no.:	NM-Motorservice Article no.:		NM-Motorservice Article no.:		NM-Motorservice Article no.:	NM-Motorservice Article no.:		NM-Motorservice Article no.:
				KBS 43300 B		KB 43300 B			



ENGINE TYPE Motortyp/ tipo de motor/ тип двигателя	LINER KIT Liner Kit/ camisas de los cilindros/ Лайнер комплект	CYL. LINER Zylinderlaufbuchse/ camisas de los cilindros/ втулка цилиндра		PISTON + RINGS Kolben + Ringe/ Pistón + Anillos/ поршень и кольца		PISTON SET Kolben Set/ Pistón Set/ поршневой	RINGS SET Ring Set/ Anillos Set/ кольца	PIN Pin/ Perno/ Пин	
SD22 5 Rings PICK UP (720 SERIES) 1979-1981 2,164 cc 4 cyl 83.0 mm Bore Ø			Liner/ Sleeve	Piston			Rings		Ø: Length:
		Length: Outside Ø: Flange Ø: Flange depth:	176.0 87.0 93.0 5.1		Length: Comp. height:		96.0 48.0 -0.7 -2.1	Top: 2nd: 3rd: 1st oil: 2nd oil:	
		Reference no.:		Reference no.:		Reference no.:	Reference no.:		Reference no.:
		11012-76200 11012-76201				12010-J5310 12010-J5312 12010-Y1411 12010-Y5210 12101-Y5211	12033-76202 12033-76203 12033-V1310 12033-Y1400 12033-Y1402 12033-Y1410/2		12030-37500
NM-Motorservice Article no./ Artikelnummer/ Modelo número/ статья номер	NM-Motorservice Article no.:	NM-Motorservice Article no.:		NM-Motorservice Article no.:		NM-Motorservice Article no.:	NM-Motorservice Article no.:		NM-Motorservice Article no.:
	LBS 43350 F LBS 43350 S	LB 43350 F LB 43350 S		KBS 43350		KB 43350	KR 43350		PB 43350



ENGINE TYPE Motortyp/ tipo de motor/ тип двигателя	LINER KIT Liner Kit/ camisas de los cilindros/ Лайнер комплект	CYL. LINER Zylinderlaufbuchse/ camisas de los cilindros/ втулка цилиндра		PISTON + RINGS Kolben + Ringe/ Pistón + Anillos/ поршень и кольца		PISTON SET Kolben Set/ Pistón Set/ поршневой	RINGS SET Ring Set/ Anillos Set/ кольца	PIN Pin/ Perno/ Пин	
SD22 3 Rings PICK UP URVAN (720 SERIES E23) 1980-1982 2,164 cc 4 cyl 83.0 mm Bore Ø			Flanged	No flange	Piston		Rings		Ø: Length:
		Length: Outside Ø: Flange Ø: Flange depth:	176.0 87.0 93.0 5.1		Length: Comp. height:	90.0 48.0 -0.5 -2.0	Top: 2nd: oil:	2.5 2.0 4.5	
		Reference no.:		Reference no.:		Reference no.:	Reference no.:		Reference no.:
		11012-76200 11012-76201				12010-36W10 12010-R8110 12010-R8111	12033-R8100 12033-R8103 12033-R8104 12033-R8110 12033-R8112 12033-R8114		12030-L2000
NM-Motorservice Article no./ Artikelnummer/ Modelo número/ статья номер	NM-Motorservice Article no.:	NM-Motorservice Article no.:		NM-Motorservice Article no.:		NM-Motorservice Article no.:	NM-Motorservice Article no.:		NM-Motorservice Article no.:
	LBS 43400 F LBS 43400 S	LB 43400 F LB 43400 S		KBS 43400		KB 43400	KR 43400		PB 43400

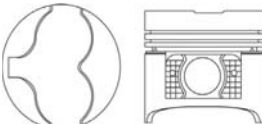

ENGINE TYPE Motortyp/ tipo de motor/ тип двигателя	LINER KIT Liner Kit/ camisas de los cilindros/ Лайнер комплект	CYL. LINER Zylinderlaufbuchse/ camisas de los cilindros/ втулка цилиндра		PISTON + RINGS Kolben + Ringe/ Pistón + Anillos/ поршень и кольца		PISTON SET Kolben Set/ Pistón Set/ поршневой	RINGS SET Ring Set/ Anillos Set/ кольца		PIN Pin/ Perno/ Пин		
M9R 780 PRIMASTAR (X83) 2006- 1,995 cc 4 cyl 84.0 mm Bore Ø			Flanged	No flange	Piston		Alfin and with oil gallery skirt MOS2 treated	Rings		Ø : Length:	30.0 65.0
		Length: Outside Ø: Flange Ø: Flange depth:	169.5 88.0 91.0 5.0	169.5 88.0	Length: Comp. height:	76.0 47.9 -5.3 -14.9		Top: 2nd: oil:	2.5 2.0 2.0		
		Reference no.:		Reference no.:		Reference no.:	Reference no.:		Reference no.:		
				12000-00Q0C 12000-00Q0D 12000-00Q0E 12000-00Q0F 12000-00Q0G			12033-00Q0A				
NM-Motorservice Article no./ Artikelnummer/ Modelo número/ статья номер	NM-Motorservice Article no.:	NM-Motorservice Article no.:		NM-Motorservice Article no.:		NM-Motorservice Article no.:	NM-Motorservice Article no.:	NM-Motorservice Article no.:		NM-Motorservice Article no.:	
	LBS 43450 PB LBS 43450 SB	LB 43450 P LB 43450 S		KBS 43450 B		KB 43450 B	KR 43450		PB 43450		

ENGINE TYPE Motortyp/ tipo de motor/ тип двигателя	LINER KIT Liner Kit/ camisas de los cilindros/ Лайнер комплект	CYL. LINER Zylinderlaufbuchse/ camisas de los cilindros/ втулка цилиндра		PISTON + RINGS Kolben + Ringe/ Pistón + Anillos/ поршень и кольца		PISTON SET Kolben Set/ Pistón Set/ поршневой	RINGS SET Ring Set/ Anillos Set/ кольца		PIN Pin/ Perno/ Пин		
M9R 780 QASHQAI X-TRAIL (J10E T31) 2007- 1,995 cc 4 cyl 84.0 mm Bore Ø			Flanged	No flange	Piston		Alfin and with oil gallery skirt MOS2 treated	Rings		Ø : Length:	32.0 65.0
		Length: Outside Ø: Flange Ø: Flange depth:	169.5 88.0 91.0 5.0	169.5 88.0	Length: Comp. height:	76.0 47.9 -5.3 -14.9		Top: 2nd: oil:	2.5 2.0 2.0		
		Reference no.:		Reference no.:		Reference no.:	Reference no.:		Reference no.:		
				12000-00Q0K 12000-00Q0L 12000-00Q0M 12000-00Q0N 12000-00Q0P			12033-00Q0A		8200580650		
NM-Motorservice Article no./ Artikelnummer/ Modelo número/ статья номер	NM-Motorservice Article no.:	NM-Motorservice Article no.:		NM-Motorservice Article no.:		NM-Motorservice Article no.:	NM-Motorservice Article no.:	NM-Motorservice Article no.:		NM-Motorservice Article no.:	
	LBS 98000 PB LBS 98000 SB	LB 98000 P LB 98000 S		KBS 98000 B		KB 98000 B	KR 98000		PB 98000		

ENGINE TYPE Motortyp/ tipo de motor/ тип двигателя	LINER KIT Liner Kit/ camisas de los cilindros/ Лайнер комплект	CYL. LINER Zylinderlaufbuchse/ camisas de los cilindros/ втулка цилиндра		PISTON + RINGS Kolben + Ringe/ Pistón + Anillos/ поршень и кольца		PISTON SET Kolben Set/ Pistón Set/ поршневой	RINGS SET Ring Set/ Anillos Set/ кольца		PIN Pin/ Perno/ Пин		
M1D QUASHQAI X-TRAIL 1,995 cc 4 cyl 84.0 mm Bore Ø			Flanged	No flange	Piston		Alfin and with oil gallery	Rings		Ø : Length:	
		Length: Outside Ø: Flange Ø: Flange depth:			Length: Comp. height:			Top: 2nd: oil:			
		Reference no.:		Reference no.:		Reference no.:	Reference no.:		Reference no.:		
NM-Motorservice Article no./ Artikelnummer/ Modelo número/ статья номер	NM-Motorservice Article no.:	NM-Motorservice Article no.:		NM-Motorservice Article no.:		NM-Motorservice Article no.:	NM-Motorservice Article no.:	NM-Motorservice Article no.:		NM-Motorservice Article no.:	
				KBS 43550 B		KB 43550 B					

ENGINE TYPE Motortyp/ tipo de motor/ тип двигателя	LINER KIT Liner Kit/ camisas de los cilindros/ Лайнер комплект	CYL. LINER Zylinderlaufbuchse/ camisas de los cilindros/ втулка цилиндра		PISTON + RINGS Kolben + Ringe/ Pistón + Anillos/ поршень и кольца		PISTON SET Kolben Set/ Pistón Set/ поршневой	RINGS SET Ring Set/ Anillos Set/ кольца		PIN Pin/ Perno/ Пин		
CD20 ALMERA PRIMERA SUNNY (N14 N15 P10E W10 Y10) 1990-1996 1,973 cc 4 cyl 84.5 mm Bore Ø			Flanged	No flange	Piston		Reference no.: 12010-57J00 12010-57J01/2/3/4 12010-57J71/2 A2010-57J00/10 A2010-57J01/2/3/4 A2010-57J11/2/6/7 A2010-8E100 A2010-E101/2/3/4	Rings		Ø : 25.0 Length: 66.5	
		Length:	148.0	148.0	Length:	75.5		Top:	2.0		2nd: oil: 2.0 3.0
		Outside Ø: Flange Ø: Flange depth:	87.5 89.5 4.8	87.5	Comp. height:	44.3 -1.2		Reference no.:	Reference no.:		
		Reference no.:		Reference no.:			Reference no.:	Reference no.:			
		11012-16A02					12033-57J00 12035-57J00 12036-57J00	12030-57J00			
NM-Motorservice Article no./ Artikelnummer/ Modelo número/ статья номер	NM-Motorservice Article no.:	NM-Motorservice Article no.:		NM-Motorservice Article no.:		NM-Motorservice Article no.:	NM-Motorservice Article no.:	NM-Motorservice Article no.:	NM-Motorservice Article no.:		
	LBS 61000 PA LBS 61000 SA	LB 61000 P LB 61000 S		KBS 61000 A		KB 61000 A	KR 61000	PB 61000			

ENGINE TYPE Motortyp/ tipo de motor/ тип двигателя	LINER KIT Liner Kit/ camisas de los cilindros/ Лайнер комплект	CYL. LINER Zylinderlaufbuchse/ camisas de los cilindros/ втулка цилиндра		PISTON + RINGS Kolben + Ringe/ Pistón + Anillos/ поршень и кольца		PISTON SET Kolben Set/ Pistón Set/ поршневой	RINGS SET Ring Set/ Anillos Set/ кольца		PIN Pin/ Perno/ Пин		
CD20T PRIMERA (P11E WP11E) 1996-1999 1,973 cc 4 cyl 84.5 mm Bore Ø			Flanged	No flange	Piston		Alfin and with oil gallery head anodized Reference no.: A2010-1C310 A2010-2J600 A2010-2J601 A2010-2J602 A2010-2J603 A2010-2J604 A2010-2J671 A2010-2J672	Rings		Ø : 28.0 Length: 66.5	
		Length:	148.0	148.0	Length:	75.6		Top:	2.0		2nd: oil: 2.0 3.0
		Outside Ø: Flange Ø: Flange depth:	87.5 89.5 4.8	87.5	Comp. height:	44.3 -1.2 -2.6		Reference no.:	Reference no.:		
		Reference no.:		Reference no.:			Reference no.:	Reference no.:			
		11012-16A02					12033-1C300 12035-1C300 12036-1C300	12030-1C300			
NM-Motorservice Article no./ Artikelnummer/ Modelo número/ статья номер	NM-Motorservice Article no.:	NM-Motorservice Article no.:		NM-Motorservice Article no.:		NM-Motorservice Article no.:	NM-Motorservice Article no.:	NM-Motorservice Article no.:	NM-Motorservice Article no.:		
	LBS 43650 PB LBS 43650 SB	LB 43650 P LB 43650 S		KBS 43650 B		KB 43650 B	KR 43650	PB 43650			

ENGINE TYPE Motortyp/ tipo de motor/ тип двигателя	LINER KIT Liner Kit/ camisas de los cilindros/ Лайнер комплект	CYL. LINER Zylinderlaufbuchse/ camisas de los cilindros/ втулка цилиндра		PISTON + RINGS Kolben + Ringe/ Pistón + Anillos/ поршень и кольца		PISTON SET Kolben Set/ Pistón Set/ поршневой	RINGS SET Ring Set/ Anillos Set/ кольца		PIN Pin/ Perno/ Пин		
LD20 BLUEBIRD VANETTE (910 SERIES C120) 1980-1981 1,952 cc 4 cyl 85.0 mm Bore Ø	Remarks: alfin pistons are not in stock		Flanged	No flange	Piston		Reference no.: 12010-W1702 12010-W1762 12010-W1764 12010-W1766 12010-18L02	Rings		Ø : 25.0 Length: 67.0	
		Length:	150.0	150.0	Length:	86.4		Top:	2.0		2nd: oil: 2.0 4.0
		Outside Ø: Flange Ø: Flange depth:	89.0 93.0 2.0	89.0	Comp. height:	46.5 -2.0 -3.3		Reference no.:	Reference no.:		
		Reference no.:		Reference no.:			Reference no.:	Reference no.:			
		11012-W1702					12033-35E25 12033-V7225 12033-W1700 12033-W3400	12030-V0700 12030-V0701			
NM-Motorservice Article no./ Artikelnummer/ Modelo número/ статья номер	NM-Motorservice Article no.:	NM-Motorservice Article no.:		NM-Motorservice Article no.:		NM-Motorservice Article no.:	NM-Motorservice Article no.:	NM-Motorservice Article no.:	NM-Motorservice Article no.:		
	LBS 43700 P LBS 43700 S	LB 43700 P LB 43700 S		KBS 43700		KB 43700	KR 43700	PB 43700			

ENGINE TYPE Motortyp/ tipo de motor/ тип двигателя	LINER KIT Liner Kit/ camisas de los cilindros/ Лайнер комплект	CYL. LINER Zylinderlaufbuchse/ camisas de los cilindros/ втулка цилиндра			PISTON + RINGS Kolben + Ringe/ Pistón + Anillos/ поршень и кольца		PISTON SET Kolben Set/ Pistón Set/ поршневой	RINGS SET Ring Set/ Anillos Set/ кольца		PIN Pin/ Perno/ Пин
LD20 II LD20 New BLUEBIRD SERENA VANETTE (C23M GC22 T12 T72 U11) 1985-1994 1,952 cc 4 cyl 85.0 mm Bore Ø			Flanged	No flange	Piston			Rings		Ø : 25.0 Length: 67.0
		Length:	150.0	150.0	Length:	78.0		Top:	2.0	
		Outside Ø:	89.0	89.0	Comp. height:	46.5				
		Flange Ø:	93.0			-1.3				
		Flange depth:	2.0			-2.8				
		Reference no.:			Reference no.:		Reference no.:	Reference no.:		Reference no.:
		11012-W1702					12010-G5502 12010-G5562 12010-G5564 12010-G5566	12033-35E25 12033-V7225 12033-W1700 12033-W3400		12030-V0700 12030-V0701
NM-Motorservice Article no./ Artikelnummer/ Modelo número/ статья номер	NM-Motorservice Article no.:	NM-Motorservice Article no.:			NM-Motorservice Article no.:		NM-Motorservice Article no.:	NM-Motorservice Article no.:		NM-Motorservice Article no.:
	LBS 43750 PA LBS 43750 SA	LB 43750 P LB 43750 S			KBS 43750 A		KB 43750 A	KR 43750		PB 43750

ENGINE TYPE Motortyp/ tipo de motor/ тип двигателя	LINER KIT Liner Kit/ camisas de los cilindros/ Лайнер комплект	CYL. LINER Zylinderlaufbuchse/ camisas de los cilindros/ втулка цилиндра			PISTON + RINGS Kolben + Ringe/ Pistón + Anillos/ поршень и кольца		PISTON SET Kolben Set/ Pistón Set/ поршневой	RINGS SET Ring Set/ Anillos Set/ кольца		PIN Pin/ Perno/ Пин
LD20T BLUEBIRD (910 SERIES U11) 1981-1986 1,952 cc 4 cyl 85.0 mm Bore Ø			Flanged	No flange	Piston		Alfin and with oil gallery	Rings		Ø : 26.0 Length: 66.0
		Length:	150.0	150.0	Length:	72.5		Top:	2.0	
		Outside Ø:	89.0	89.0	Comp. height:	46.5	2nd:	2.0		
		Flange Ø:	93.0			-2.0	oil:	4.0		
		Flange depth:	2.0			-2.4				
		Reference no.:			Reference no.:		Reference no.:	Reference no.:		Reference no.:
		11012-W1702					12010-W3402 12010-W3404 12010-W3406	12033-35E10 12033-W4200 12036-35E10 12036-W4200 12038-35E10 12038-W4200		12030-W3400
NM-Motorservice Article no./ Artikelnummer/ Modelo número/ статья номер	NM-Motorservice Article no.:	NM-Motorservice Article no.:			NM-Motorservice Article no.:		NM-Motorservice Article no.:	NM-Motorservice Article no.:		NM-Motorservice Article no.:
	LBS 43800 PB LBS 43800 SB	LB 43800 P LB 43800 S			KBS 43800 B		KB 43800 B	KR 43800		PB 43800

ENGINE TYPE Motortyp/ tipo de motor/ тип двигателя	LINER KIT Liner Kit/ camisas de los cilindros/ Лайнер комплект	CYL. LINER Zylinderlaufbuchse/ camisas de los cilindros/ втулка цилиндра			PISTON + RINGS Kolben + Ringe/ Pistón + Anillos/ поршень и кольца		PISTON SET Kolben Set/ Pistón Set/ поршневой	RINGS SET Ring Set/ Anillos Set/ кольца		PIN Pin/ Perno/ Пин
M9T NV400 2,298 cc 4 cyl 85.0 mm Bore Ø			Flanged	No flange	Piston		Alfin and with oil gallery	Rings		Ø : Length:
		Length:			Length:			Top:		
		Outside Ø:			Comp. height:		2nd:			
		Flange Ø:					oil:			
		Flange depth:								
		Reference no.:			Reference no.:		Reference no.:	Reference no.:		Reference no.:
NM-Motorservice Article no./ Artikelnummer/ Modelo número/ статья номер	NM-Motorservice Article no.:	NM-Motorservice Article no.:			NM-Motorservice Article no.:		NM-Motorservice Article no.:	NM-Motorservice Article no.:		NM-Motorservice Article no.:
					KBS 43850 B		KB 43850 B			

ENGINE TYPE Motortyp/ tipo de motor/ тип двигателя	LINER KIT Liner Kit/ camisas de los cilindros/ Лайнер комплект	CYL. LINER Zylinderlaufbuchse/ camisas de los cilindros/ втулка цилиндра	PISTON + RINGS Kolben + Ringe/ Pistón + Anillos/ поршень и кольца	PISTON SET Kolben Set/ Pistón Set/ поршневой	RINGS SET Ring Set/ Anillos Set/ кольца	PIN Pin/ Perno/ Пин																																										
YD22DDT/ DDTi YD22ETi/ TDi ALMERA PRIMERA X-TRAIL (N16E P12E T30 V10M) 2003- 2,184 cc 4 cyl 86.0 mm Bore Ø		<table border="1"> <tr> <td></td> <td>Flanged</td> <td>No flange</td> <td rowspan="2">Piston</td> </tr> <tr> <td>Length:</td> <td>160.0</td> <td>160.0</td> </tr> <tr> <td>Outside Ø:</td> <td>90.0</td> <td>90.0</td> <td>Length:</td> <td>73.8</td> </tr> <tr> <td>Flange Ø:</td> <td>94.0</td> <td></td> <td>Comp. height:</td> <td>48.6</td> </tr> <tr> <td>Flange depth:</td> <td>5.0</td> <td></td> <td></td> <td>-6.7</td> </tr> <tr> <td></td> <td></td> <td></td> <td></td> <td>-15.2</td> </tr> </table>		Flanged	No flange	Piston	Length:	160.0	160.0	Outside Ø:	90.0	90.0	Length:	73.8	Flange Ø:	94.0		Comp. height:	48.6	Flange depth:	5.0			-6.7					-15.2	Alfin and with oil gallery skirt MOS2 treated	<table border="1"> <tr> <td colspan="2">Rings</td> <td></td> <td></td> </tr> <tr> <td>Top:</td> <td>2.0</td> <td rowspan="3">Ø:</td> <td rowspan="3">28.0</td> </tr> <tr> <td>2nd:</td> <td>2.0</td> </tr> <tr> <td>oil:</td> <td>3.0</td> </tr> <tr> <td></td> <td></td> <td>Length:</td> <td>69.0</td> </tr> </table>	Rings				Top:	2.0	Ø:	28.0	2nd:	2.0	oil:	3.0			Length:	69.0	
			Flanged	No flange	Piston																																											
		Length:	160.0	160.0																																												
Outside Ø:	90.0	90.0	Length:	73.8																																												
Flange Ø:	94.0		Comp. height:	48.6																																												
Flange depth:	5.0			-6.7																																												
				-15.2																																												
Rings																																																
Top:	2.0	Ø:	28.0																																													
2nd:	2.0																																															
oil:	3.0																																															
		Length:	69.0																																													
Reference no.:	Reference no.:	Reference no.:	Reference no.:	Reference no.:																																												
			A2010-AW400 A2010-AW401 A2010-AW402 A2010-AW471 A2010-AW472	12033-AW400 12033-4U400 12033-8H800 12033-8H810 12033-ES60A	12030-AD200																																											
NM-Motorservice Article no./ Artikelnummer/ Modelo número/ статья номер	NM-Motorservice Article no.:	NM-Motorservice Article no.:	NM-Motorservice Article no.:	NM-Motorservice Article no.:	NM-Motorservice Article no.:	NM-Motorservice Article no.:																																										
	LBS 31000 PB LBS 31000 SB	LB 31000 P LB 31000 S	KBS 31000 B	KB 31000 B	KR 31000	PB 31000																																										



ENGINE TYPE Motortyp/ tipo de motor/ тип двигателя	LINER KIT Liner Kit/ camisas de los cilindros/ Лайнер комплект	CYL. LINER Zylinderlaufbuchse/ camisas de los cilindros/ втулка цилиндра	PISTON + RINGS Kolben + Ringe/ Pistón + Anillos/ поршень и кольца	PISTON SET Kolben Set/ Pistón Set/ поршневой	RINGS SET Ring Set/ Anillos Set/ кольца	PIN Pin/ Perno/ Пин																																										
YD22DDT/ DDTi ALMERA (N16E V10M) 2002- 2,184 cc 4 cyl 86.0 mm Bore Ø		<table border="1"> <tr> <td></td> <td>Flanged</td> <td>No flange</td> <td rowspan="2">Piston</td> </tr> <tr> <td>Length:</td> <td>160.0</td> <td>160.0</td> </tr> <tr> <td>Outside Ø:</td> <td>90.0</td> <td>90.0</td> <td>Length:</td> <td>80.1</td> </tr> <tr> <td>Flange Ø:</td> <td>94.0</td> <td></td> <td>Comp. height:</td> <td>49.0</td> </tr> <tr> <td>Flange depth:</td> <td>5.0</td> <td></td> <td></td> <td>-6.7</td> </tr> <tr> <td></td> <td></td> <td></td> <td></td> <td>-16.8</td> </tr> </table>		Flanged	No flange	Piston	Length:	160.0	160.0	Outside Ø:	90.0	90.0	Length:	80.1	Flange Ø:	94.0		Comp. height:	49.0	Flange depth:	5.0			-6.7					-16.8	Alfin and with oil gallery skirt MOS2 treated	<table border="1"> <tr> <td colspan="2">Rings</td> <td></td> <td></td> </tr> <tr> <td>Top:</td> <td>2.0</td> <td rowspan="3">Ø:</td> <td rowspan="3">28.0</td> </tr> <tr> <td>2nd:</td> <td>2.0</td> </tr> <tr> <td>oil:</td> <td>3.0</td> </tr> <tr> <td></td> <td></td> <td>Length:</td> <td>60.0</td> </tr> </table>	Rings				Top:	2.0	Ø:	28.0	2nd:	2.0	oil:	3.0			Length:	60.0	
			Flanged	No flange	Piston																																											
		Length:	160.0	160.0																																												
Outside Ø:	90.0	90.0	Length:	80.1																																												
Flange Ø:	94.0		Comp. height:	49.0																																												
Flange depth:	5.0			-6.7																																												
				-16.8																																												
Rings																																																
Top:	2.0	Ø:	28.0																																													
2nd:	2.0																																															
oil:	3.0																																															
		Length:	60.0																																													
Reference no.:	Reference no.:	Reference no.:	Reference no.:	Reference no.:																																												
			A2010-4U165 A2010-4U166 A2010-4U167 A2010-4U183 A2010-4U184	12033-AW400 12033-4U400 12033-8H800 12033-8H810 12033-ES60A	12030-AD200																																											
NM-Motorservice Article no./ Artikelnummer/ Modelo número/ статья номер	NM-Motorservice Article no.:	NM-Motorservice Article no.:	NM-Motorservice Article no.:	NM-Motorservice Article no.:	NM-Motorservice Article no.:	NM-Motorservice Article no.:																																										
	LBS 30000 PB LBS 30000 SB	LB 30000 P LB 30000 S	KBS 30000 B	KB 30000 B	KR 30000	PB 30000																																										



ENGINE TYPE Motortyp/ tipo de motor/ тип двигателя	LINER KIT Liner Kit/ camisas de los cilindros/ Лайнер комплект	CYL. LINER Zylinderlaufbuchse/ camisas de los cilindros/ втулка цилиндра	PISTON + RINGS Kolben + Ringe/ Pistón + Anillos/ поршень и кольца	PISTON SET Kolben Set/ Pistón Set/ поршневой	RINGS SET Ring Set/ Anillos Set/ кольца	PIN Pin/ Perno/ Пин																																										
YD22DDT / ETi PRIMERA X-TRAIL (P12E T30) 2001-2003 2,184 cc 4 cyl 86.0 mm Bore Ø		<table border="1"> <tr> <td></td> <td>Flanged</td> <td>No flange</td> <td rowspan="2">Piston</td> </tr> <tr> <td>Length:</td> <td>160.0</td> <td>160.0</td> </tr> <tr> <td>Outside Ø:</td> <td>90.0</td> <td>90.0</td> <td>Length:</td> <td>79.9</td> </tr> <tr> <td>Flange Ø:</td> <td>94.0</td> <td></td> <td>Comp. height:</td> <td>49.0</td> </tr> <tr> <td>Flange depth:</td> <td>5.0</td> <td></td> <td></td> <td>-8.6</td> </tr> <tr> <td></td> <td></td> <td></td> <td></td> <td>-16.3</td> </tr> </table>		Flanged	No flange	Piston	Length:	160.0	160.0	Outside Ø:	90.0	90.0	Length:	79.9	Flange Ø:	94.0		Comp. height:	49.0	Flange depth:	5.0			-8.6					-16.3	Alfin and with oil gallery skirt MOS2 treated	<table border="1"> <tr> <td colspan="2">Rings</td> <td></td> <td></td> </tr> <tr> <td>Top:</td> <td>2.0</td> <td rowspan="3">Ø:</td> <td rowspan="3">28.0</td> </tr> <tr> <td>2nd:</td> <td>2.0</td> </tr> <tr> <td>oil:</td> <td>3.0</td> </tr> <tr> <td></td> <td></td> <td>Length:</td> <td>61.5</td> </tr> </table>	Rings				Top:	2.0	Ø:	28.0	2nd:	2.0	oil:	3.0			Length:	61.5	
			Flanged	No flange	Piston																																											
		Length:	160.0	160.0																																												
Outside Ø:	90.0	90.0	Length:	79.9																																												
Flange Ø:	94.0		Comp. height:	49.0																																												
Flange depth:	5.0			-8.6																																												
				-16.3																																												
Rings																																																
Top:	2.0	Ø:	28.0																																													
2nd:	2.0																																															
oil:	3.0																																															
		Length:	61.5																																													
Reference no.:	Reference no.:	Reference no.:	Reference no.:	Reference no.:																																												
			A2010-8H800 A2010-8H801 A2010-8H802 A2010-8H865 A2010-8H871 A2010-8H872	12033-AW400 12033-4U400 12033-8H800 12033-8H810 12033-ES60A	12030-AD200																																											
NM-Motorservice Article no./ Artikelnummer/ Modelo número/ статья номер	NM-Motorservice Article no.:	NM-Motorservice Article no.:	NM-Motorservice Article no.:	NM-Motorservice Article no.:	NM-Motorservice Article no.:	NM-Motorservice Article no.:																																										
	LBS 30100 PB LBS 30100 SB	LB 30100 P LB 30100 S	KBS 30100 B	KB 30100 B	KR 30100	PB 30100																																										



ENGINE TYPE Motor/тип de motor/ тип двигателя	LINER KIT Liner Kit/ camisas de los cilindros/ Лайнер комплект	CYL. LINER Zylinderlaufbuchse/ camisas de los cilindros/ втулка цилиндра		PISTON + RINGS Kolben + Ringe/ Pistón + Anillos/ поршень и кольца		PISTON SET Kolben Set/ Pistón Set/ поршневой	RINGS SET Ring Set/ Anillos Set/ кольца		PIN Pin/ Perno/ Пин		
YD22 ETi X-TRAIL (T30) 2005- 2,184 cc 4 cyl 86.0 mm Bore Ø			Flanged	No flange	Piston		Rings				
		Length: Outside Ø: Flange Ø: Flange depth:	160.0 90.0 94.0 5.0	160.0 90.0	Length: Comp. height:	73.9 48.9 -7.8 -15.2					
		Reference no.:		Reference no.:		Reference no.:		Reference no.:		Reference no.:	
						A2010-ES60A A2010-ES61A A2010-ES62A A2010-ES68A A2010-ES69A		12033-AW400 12033-4U400 12033-8H800 12033-8H810 12033-ES60A		12030-AD200	
NM-Motorservice Article no./ Artikelnummer/ Modelo número/ статья номер	NM-Motorservice Article no.:	NM-Motorservice Article no.:		NM-Motorservice Article no.:		NM-Motorservice Article no.:		NM-Motorservice Article no.:		NM-Motorservice Article no.:	
	LBS 30150 PB LBS 30150 SB	LB 30150 P LB 30150 S		KBS 30150 B		KB 30150 B		KR 30150		PB 30150	

ENGINE TYPE Motor/тип de motor/ тип двигателя	LINER KIT Liner Kit/ camisas de los cilindros/ Лайнер комплект	CYL. LINER Zylinderlaufbuchse/ camisas de los cilindros/ втулка цилиндра		PISTON + RINGS Kolben + Ringe/ Pistón + Anillos/ поршень и кольца		PISTON SET Kolben Set/ Pistón Set/ поршневой	RINGS SET Ring Set/ Anillos Set/ кольца		PIN Pin/ Perno/ Пин		
LD23 SERENA (C23M) 1994- 2,283 cc 4 cyl 87.0 mm Bore Ø			Flanged	No flange	Piston		Rings				
		Length: Outside Ø: Flange Ø: Flange depth:	160.0 91.0 95.0 2.0	160.0 91.0	Length: Comp. height:	76.2 47.2 -2.2					
		Reference no.:		Reference no.:		Reference no.:		Reference no.:		Reference no.:	
						12010-9C600 12010-9C625 12010-9C626 12010-9C627 12010-9C628 12010-9C629 A2010-9C626		12033-2J626 12033-9C625 12033-9C626 12035-9C626		12030-9C600	
NM-Motorservice Article no./ Artikelnummer/ Modelo número/ статья номер	NM-Motorservice Article no.:	NM-Motorservice Article no.:		NM-Motorservice Article no.:		NM-Motorservice Article no.:		NM-Motorservice Article no.:		NM-Motorservice Article no.:	
	LBS 43000 PA LBS 43000 SA	LB 43000 P LB 43000 S		KBS 43000 A		KB 43000 A		KR 43000		PB 43000	

ENGINE TYPE Motor/тип de motor/ тип двигателя	LINER KIT Liner Kit/ camisas de los cilindros/ Лайнер комплект	CYL. LINER Zylinderlaufbuchse/ camisas de los cilindros/ втулка цилиндра		PISTON + RINGS Kolben + Ringe/ Pistón + Anillos/ поршень и кольца		PISTON SET Kolben Set/ Pistón Set/ поршневой	RINGS SET Ring Set/ Anillos Set/ кольца		PIN Pin/ Perno/ Пин		
G9T 722 INTERSTAR 2.2 DCI (X70) 2002- 2,188 cc 4 cyl 87.0 mm Bore Ø			Flanged	No flange	Piston		Rings				
		Length: Outside Ø: Flange Ø: Flange depth:	162.0 91.05 92.5 4.0	162.0 91.05	Length: Comp. height:	84.2 54.53 -5.8 -17.5					
		Reference no.:		Reference no.:		Reference no.:		Reference no.:		Reference no.:	
				12000-00QAJ 12000-00QAK				A2033-00QAB A2033-00QAE			
NM-Motorservice Article no./ Artikelnummer/ Modelo número/ статья номер	NM-Motorservice Article no.:	NM-Motorservice Article no.:		NM-Motorservice Article no.:		NM-Motorservice Article no.:		NM-Motorservice Article no.:		NM-Motorservice Article no.:	
	LBS 30250 PA LBS 30250 SA	LB 30250 P LB 30250 S		KBS 30250 A		KB 30250 A		KR 30250		PB 30250	

ENGINE TYPE Motortyp/ tipo de motor/ тип двигателя	LINER KIT Liner Kit/ camisas de los cilindros/ Лайнер комплект	CYL. LINER Zylinderlaufbuchse/ camisas de los cilindros/ втулка цилиндра	PISTON + RINGS Kolben + Ringe/ Pistón + Anillos/ поршень и кольца	PISTON SET Kolben Set/ Pistón Set/ поршневой	RINGS SET Ring Set/ Anillos Set/ кольца	PIN Pin/ Perno/ Пин																																
SD23 SD25 CABSTAR KING CAB PICK UP (720 SERIES D21 E23 F22) 1982-1987 2,289 cc / 2,488 cc 4 cyl 89.0 mm Bore Ø		<table border="1"> <tr> <td>Liner/ Sleeve</td> <td></td> </tr> <tr> <td>Length:</td> <td>172.0</td> </tr> <tr> <td>Outside Ø:</td> <td>92.0</td> </tr> <tr> <td>Flange Ø:</td> <td>98.0</td> </tr> <tr> <td>Flange depth:</td> <td>5.0</td> </tr> </table>	Liner/ Sleeve		Length:	172.0	Outside Ø:	92.0	Flange Ø:	98.0	Flange depth:	5.0	<table border="1"> <tr> <td colspan="2">Piston</td> </tr> <tr> <td>Length:</td> <td>90.0</td> </tr> <tr> <td>Comp. height:</td> <td>48.1</td> </tr> <tr> <td></td> <td>-2.5</td> </tr> </table>	Piston		Length:	90.0	Comp. height:	48.1		-2.5	<table border="1"> <tr> <td>Reference no.:</td> <td>12010-09W01/11 12010-29W00 12010-L2002 12010-T6203 12010-T6213/6 12010-T6273 12010-T7200/2 12010-T7210/2</td> </tr> </table>	Reference no.:	12010-09W01/11 12010-29W00 12010-L2002 12010-T6203 12010-T6213/6 12010-T6273 12010-T7200/2 12010-T7210/2	<table border="1"> <tr> <td colspan="2">Rings</td> </tr> <tr> <td>Top:</td> <td>2.5</td> </tr> <tr> <td>2nd:</td> <td>2.0</td> </tr> <tr> <td>oil:</td> <td>4.5</td> </tr> </table>	Rings		Top:	2.5	2nd:	2.0	oil:	4.5	<table border="1"> <tr> <td>Ø:</td> <td>26.0</td> </tr> <tr> <td>Length:</td> <td>74.0</td> </tr> </table>	Ø:	26.0	Length:	74.0
		Liner/ Sleeve																																				
		Length:	172.0																																			
Outside Ø:	92.0																																					
Flange Ø:	98.0																																					
Flange depth:	5.0																																					
Piston																																						
Length:	90.0																																					
Comp. height:	48.1																																					
	-2.5																																					
Reference no.:	12010-09W01/11 12010-29W00 12010-L2002 12010-T6203 12010-T6213/6 12010-T6273 12010-T7200/2 12010-T7210/2																																					
Rings																																						
Top:	2.5																																					
2nd:	2.0																																					
oil:	4.5																																					
Ø:	26.0																																					
Length:	74.0																																					
NM-Motorservice Article no./ Artikelnummer/ Modelo número/ статья номер	NM-Motorservice Article no.:	NM-Motorservice Article no.:	NM-Motorservice Article no.:	NM-Motorservice Article no.:	NM-Motorservice Article no.:	NM-Motorservice Article no.:																																
	LBS 90000 F LBS 90000 S LBS 90000 FA LBS 90000 SA	LB 90000 F LB 90000 S	KBS 90000 KBS 90000 A	KB 90000 KB 90000 A	KR 90000	PB 90000																																

ENGINE TYPE Motortyp/ tipo de motor/ тип двигателя	LINER KIT Liner Kit/ camisas de los cilindros/ Лайнер комплект	CYL. LINER Zylinderlaufbuchse/ camisas de los cilindros/ втулка цилиндра	PISTON + RINGS Kolben + Ringe/ Pistón + Anillos/ поршень и кольца	PISTON SET Kolben Set/ Pistón Set/ поршневой	RINGS SET Ring Set/ Anillos Set/ кольца	PIN Pin/ Perno/ Пин																																
SD23 New SD25 New FORKLIFT KING CAB PICK UP (720 SERIES D21 H01 H02) 1983-1993 2,289 cc / 2,488 cc 4 cyl 89.0 mm Bore Ø		<table border="1"> <tr> <td>Liner/ Sleeve</td> <td></td> </tr> <tr> <td>Length:</td> <td>172.0</td> </tr> <tr> <td>Outside Ø:</td> <td>92.0</td> </tr> <tr> <td>Flange Ø:</td> <td>98.0</td> </tr> <tr> <td>Flange depth:</td> <td>5.0</td> </tr> </table>	Liner/ Sleeve		Length:	172.0	Outside Ø:	92.0	Flange Ø:	98.0	Flange depth:	5.0	<table border="1"> <tr> <td colspan="2">Piston</td> </tr> <tr> <td>Length:</td> <td>80.0</td> </tr> <tr> <td>Comp. height:</td> <td>48.0</td> </tr> <tr> <td></td> <td>-2.9</td> </tr> </table>	Piston		Length:	80.0	Comp. height:	48.0		-2.9	<table border="1"> <tr> <td>Reference no.:</td> <td>12010-06W10 12010-09W10 12010-L2012 12010-T6202/5/6 12010-T7204/5/6 12010-T7214/5 12010-T7274</td> </tr> </table>	Reference no.:	12010-06W10 12010-09W10 12010-L2012 12010-T6202/5/6 12010-T7204/5/6 12010-T7214/5 12010-T7274	<table border="1"> <tr> <td colspan="2">Rings</td> </tr> <tr> <td>Top:</td> <td>2.5</td> </tr> <tr> <td>2nd:</td> <td>2.0</td> </tr> <tr> <td>oil:</td> <td>4.5</td> </tr> </table>	Rings		Top:	2.5	2nd:	2.0	oil:	4.5	<table border="1"> <tr> <td>Ø:</td> <td>26.0</td> </tr> <tr> <td>Length:</td> <td>74.0</td> </tr> </table>	Ø:	26.0	Length:	74.0
		Liner/ Sleeve																																				
		Length:	172.0																																			
Outside Ø:	92.0																																					
Flange Ø:	98.0																																					
Flange depth:	5.0																																					
Piston																																						
Length:	80.0																																					
Comp. height:	48.0																																					
	-2.9																																					
Reference no.:	12010-06W10 12010-09W10 12010-L2012 12010-T6202/5/6 12010-T7204/5/6 12010-T7214/5 12010-T7274																																					
Rings																																						
Top:	2.5																																					
2nd:	2.0																																					
oil:	4.5																																					
Ø:	26.0																																					
Length:	74.0																																					
NM-Motorservice Article no./ Artikelnummer/ Modelo número/ статья номер	NM-Motorservice Article no.:	NM-Motorservice Article no.:	NM-Motorservice Article no.:	NM-Motorservice Article no.:	NM-Motorservice Article no.:	NM-Motorservice Article no.:																																
	LBS 30350 FA LBS 30350 SA	LB 30350 F LB 30350 S	KBS 30350 A	KB 30350 A	KR 30350	PB 30350																																

ENGINE TYPE Motortyp/ tipo de motor/ тип двигателя	LINER KIT Liner Kit/ camisas de los cilindros/ Лайнер комплект	CYL. LINER Zylinderlaufbuchse/ camisas de los cilindros/ втулка цилиндра	PISTON + RINGS Kolben + Ringe/ Pistón + Anillos/ поршень и кольца	PISTON SET Kolben Set/ Pistón Set/ поршневой	RINGS SET Ring Set/ Anillos Set/ кольца	PIN Pin/ Perno/ Пин																																		
TD23 CABSTAR URVAN (E24 F22) 1987-1989 2,289 cc 4 cyl 89.0 mm Bore Ø		<table border="1"> <tr> <td>Liner/ Sleeve</td> <td></td> </tr> <tr> <td>Length:</td> <td>160.0</td> </tr> <tr> <td>Outside Ø:</td> <td>92.0</td> </tr> <tr> <td>Flange Ø:</td> <td>98.0</td> </tr> <tr> <td>Flange depth:</td> <td>5.0</td> </tr> </table>	Liner/ Sleeve		Length:	160.0	Outside Ø:	92.0	Flange Ø:	98.0	Flange depth:	5.0	<table border="1"> <tr> <td colspan="2">Piston</td> </tr> <tr> <td>Length:</td> <td>84.0</td> </tr> <tr> <td>Comp. height:</td> <td>48.2</td> </tr> <tr> <td></td> <td>-0.8</td> </tr> <tr> <td></td> <td>-1.6</td> </tr> </table>	Piston		Length:	84.0	Comp. height:	48.2		-0.8		-1.6	<table border="1"> <tr> <td>Reference no.:</td> <td>12010-02N06 12010-02N07 12010-02N16 12010-02N17</td> </tr> </table>	Reference no.:	12010-02N06 12010-02N07 12010-02N16 12010-02N17	<table border="1"> <tr> <td colspan="2">Rings</td> </tr> <tr> <td>Top:</td> <td>2.5</td> </tr> <tr> <td>2nd:</td> <td>2.0</td> </tr> <tr> <td>oil:</td> <td>4.0</td> </tr> </table>	Rings		Top:	2.5	2nd:	2.0	oil:	4.0	<table border="1"> <tr> <td>Ø:</td> <td>26.0</td> </tr> <tr> <td>Length:</td> <td>74.0</td> </tr> </table>	Ø:	26.0	Length:	74.0
		Liner/ Sleeve																																						
		Length:	160.0																																					
Outside Ø:	92.0																																							
Flange Ø:	98.0																																							
Flange depth:	5.0																																							
Piston																																								
Length:	84.0																																							
Comp. height:	48.2																																							
	-0.8																																							
	-1.6																																							
Reference no.:	12010-02N06 12010-02N07 12010-02N16 12010-02N17																																							
Rings																																								
Top:	2.5																																							
2nd:	2.0																																							
oil:	4.0																																							
Ø:	26.0																																							
Length:	74.0																																							
NM-Motorservice Article no./ Artikelnummer/ Modelo número/ статья номер	NM-Motorservice Article no.:	NM-Motorservice Article no.:	NM-Motorservice Article no.:	NM-Motorservice Article no.:	NM-Motorservice Article no.:	NM-Motorservice Article no.:																																		
	LBS 30400 FA LBS 30400 SA	LB 30400 F LB 30400 S	KBS 30400 A	KB 30400 A	KR 30400	PB 30400																																		

ENGINE TYPE Motortyp/ tipo de motor/ тип двигателя	LINER KIT Liner Kit/ camisas de los cilindros/ Лайнер комплект	CYL. LINER Zylinderlaufbuchse/ camisas de los cilindros/ втулка цилиндра		PISTON + RINGS Kolben + Ringe/ Pistón + Anillos/ поршень и кольца		PISTON SET Kolben Set/ Pistón Set/ поршневой	RINGS SET Ring Set/ Anillos Set/ кольца		PIN Pin/ Perno/ Пин	
YD25DDTi HARDBODY KING CAB (D22 D2S) 2001-2007 2,488 cc 4 cyl 89.0 mm Bore Ø			Flanged	No flange	Piston		Alfin and with oil gallery	Rings		Ø : 28.0 Length: 61.0
		Length: 167.0 Outside Ø: 92.5 Flange Ø: 94.0 Flange depth: 4.0	167.0 92.5	Length: 80.0 Comp. height: 48.8 -7.7 -18.1	Top: 2.0 2nd: 2.0 oil: 3.0					
		Reference no.:		Reference no.:		Reference no.:	Reference no.:		Reference no.:	
						A2010-VK510 A2010-VK511/2 A2010-VK515/6/7 A5010-VK576/7 A2010-VK581/2 A2010-VK50A A2010-VK51A A2010-VK52A A2010-VK58A A2010-VK59A			12030-AD200	
NM-Motorservice Article no./ Artikelnummer/ Modelo нúmero/ статья номер	NM-Motorservice Article no.:	NM-Motorservice Article no.:		NM-Motorservice Article no.:		NM-Motorservice Article no.:	NM-Motorservice Article no.:	NM-Motorservice Article no.:		NM-Motorservice Article no.:
	LBS 17000 PB LBS 17000 SB	LB 17000 P LB 17000 S		KBS 17000 B		KB 17000 B	KR 17000	PB 17000		

ENGINE TYPE Motortyp/ tipo de motor/ тип двигателя	LINER KIT Liner Kit/ camisas de los cilindros/ Лайнер комплект	CYL. LINER Zylinderlaufbuchse/ camisas de los cilindros/ втулка цилиндра		PISTON + RINGS Kolben + Ringe/ Pistón + Anillos/ поршень и кольца		PISTON SET Kolben Set/ Pistón Set/ поршневой	RINGS SET Ring Set/ Anillos Set/ кольца		PIN Pin/ Perno/ Пин	
YD25DDTi NAVARA PATHFINDER (D40M R51M) 2005- 2,488 cc 4 cyl 89.0 mm Bore Ø			Flanged	No flange	Piston		Alfin and with oil gallery skirt MOS2 treated	Rings		Ø : 28.0 Length: 71.0
		Length: 167.0 Outside Ø: 92.5 Flange Ø: 94.0 Flange depth: 4.0	167.0 92.5	Length: 73.8 Comp. height: 48.9 -8.8 -19.2	Top: 2.0 2nd: 2.0 oil: 3.0					
		Reference no.:		Reference no.:		Reference no.:	Reference no.:		Reference no.:	
						A2010-EB30A A2010-EB31A A2010-EB32A A2010-EB38A A2010-EB39A	12033-VK500 12033-VK510 12033-VK520 12033-EB300 12033-EB30A/B A2033-VK510/20		12030-AD200	
NM-Motorservice Article no./ Artikelnummer/ Modelo нúmero/ статья номер	NM-Motorservice Article no.:	NM-Motorservice Article no.:		NM-Motorservice Article no.:		NM-Motorservice Article no.:	NM-Motorservice Article no.:	NM-Motorservice Article no.:		NM-Motorservice Article no.:
	LBS 19500 PB LBS 19500 SB	LB 19500 P LB 19500 S		KBS 19500 B		KB 19500 B	KR 19500	PB 19500		

ENGINE TYPE Motortyp/ tipo de motor/ тип двигателя	LINER KIT Liner Kit/ camisas de los cilindros/ Лайнер комплект	CYL. LINER Zylinderlaufbuchse/ camisas de los cilindros/ втулка цилиндра		PISTON + RINGS Kolben + Ringe/ Pistón + Anillos/ поршень и кольца		PISTON SET Kolben Set/ Pistón Set/ поршневой	RINGS SET Ring Set/ Anillos Set/ кольца		PIN Pin/ Perno/ Пин	
G9U 720 INTERSTAR 2.5 DCI also for OPEL RENAULT 2,463 cc 4 cyl 89.0 mm Bore Ø	superseded by LBS 30600 PA LBS 30600 SA		Flanged	No flange	Piston		Alfin skirt MOS2 treated	Rings		Ø : 31.0 Length: 65.0
		Length: 167.0 Outside Ø: 92.5 Flange Ø: 94.0 Flange depth: 4.0	167.0 92.5	Length: 83.09 Comp. height: 53.03 -5.8 -17.85	Top: 3.0 2nd: 1.75 oil: 2.5					
		Reference no.:		Reference no.:		Reference no.:	Reference no.:		Reference no.:	
						K-99424600 superseded by KBS 30600 A	superseded by KB 30600 A		K-800053240000 K-800059040000	
NM-Motorservice Article no./ Artikelnummer/ Modelo нúmero/ статья номер	NM-Motorservice Article no.:	NM-Motorservice Article no.:		NM-Motorservice Article no.:		NM-Motorservice Article no.:	NM-Motorservice Article no.:	NM-Motorservice Article no.:		NM-Motorservice Article no.:
	LBS 30550 PA LBS 30550 SA	LB 30550 P LB 30550 S		KBS 30550 A		KB 30550 A	KR 30550	PB 30550		

ENGINE TYPE Motortyp/ tipo de motor/ тип двигателя	LINER KIT Liner Kit/ camisas de los cilindros/ Лайнер комплект	CYL. LINER Zylinderlaufbuchse/ camisas de los cilindros/ втулка цилиндра		PISTON + RINGS Kolben + Ringe/ Pistón + Anillos/ поршень и кольца		PISTON SET Kolben Set/ Pistón Set/ поршневой	RINGS SET Ring Set/ Anillos Set/ кольца		PIN Pin/ Perno/ Пин		
G9U 720/724 G9U 730/750/754 INTERSTAR PRIMASTAR 2.5 DCI (X70 X83) 2002- 2,463 cc 4 cyl 89.0 mm Bore Ø			Flanged	No flange	Piston		Alfin skirt MOS2 treated	Rings		Ø : 31.0 Length: 65.0	
		Length:	167.0	167.0	Length:	83.09		Top:	2.5		2nd: oil: 1.75 2.5
		Outside Ø:	92.5	92.5	Comp. height:	53.03					
		Flange Ø:	94.0								
		Flange depth:	4.0								
		Reference no.:		Reference no.:		Reference no.:		Reference no.:		Reference no.:	
				12000-00Q0A 12000-00Q0B 12000-00QAG 12000-00QAH				A2033-00QAC A2033-00QAF			
NM-Motorservice Article no./ Artikelnummer/ Modelo número/ статья номер		NM-Motorservice Article no.:		NM-Motorservice Article no.:		NM-Motorservice Article no.:		NM-Motorservice Article no.:		NM-Motorservice Article no.:	
		LBS 30600 PA LBS 30600 SA		LB 30600 P LB 30600 S		KBS 30600 A		KB 30600 A		KR 30600 PB 30600	



ENGINE TYPE Motortyp/ tipo de motor/ тип двигателя	LINER KIT Liner Kit/ camisas de los cilindros/ Лайнер комплект	CYL. LINER Zylinderlaufbuchse/ camisas de los cilindros/ втулка цилиндра		PISTON + RINGS Kolben + Ringe/ Pistón + Anillos/ поршень и кольца		PISTON SET Kolben Set/ Pistón Set/ поршневой	RINGS SET Ring Set/ Anillos Set/ кольца		PIN Pin/ Perno/ Пин		
G9U 630/632/635 INTERSTAR PRIMASTAR 2.5 DCI (X70 X83) 2006- 2,463 cc 4 cyl 89.0 mm Bore Ø			Flanged	No flange	Piston		Alfin and with oil gallery skirt MOS2 treated	Rings		Ø : 31.0 Length: 68.0	
		Length:	167.0	167.0	Length:	83.09		Top:	3.0		2nd: oil: 1.75 2.5
		Outside Ø:	92.5	92.5	Comp. height:	53.07					
		Flange Ø:	94.0								
		Flange depth:	4.0								
		Reference no.:		Reference no.:		Reference no.:		Reference no.:		Reference no.:	
				12000-00Q0H 12000-00Q0J				A2033-00Q0A			
NM-Motorservice Article no./ Artikelnummer/ Modelo número/ статья номер		NM-Motorservice Article no.:		NM-Motorservice Article no.:		NM-Motorservice Article no.:		NM-Motorservice Article no.:		NM-Motorservice Article no.:	
		LBS 30650 PB LBS 30650 SB		LB 30650 P LB 30650 S		KBS 30650 B		KB 30650 B		KR 30650 PB 30650	



ENGINE TYPE Motortyp/ tipo de motor/ тип двигателя	LINER KIT Liner Kit/ camisas de los cilindros/ Лайнер комплект	CYL. LINER Zylinderlaufbuchse/ camisas de los cilindros/ втулка цилиндра		PISTON + RINGS Kolben + Ringe/ Pistón + Anillos/ поршень и кольца		PISTON SET Kolben Set/ Pistón Set/ поршневой	RINGS SET Ring Set/ Anillos Set/ кольца		PIN Pin/ Perno/ Пин		
YD25DDTi CABSTAR NAVARA PATHFINDER (F24M F40M R51M) 2006- 2,488 cc 4 cyl 89.0 mm Bore Ø			Flanged	No flange	Piston		Alfin and with oil gallery skirt MOS2 treated	Rings		Ø : 28.0 Length: 71.0	
		Length:	167.0	167.0	Length:	73.8		Top:	2.0		2nd: oil: 2.0 3.0
		Outside Ø:	92.5	92.5	Comp. height:	48.9					
		Flange Ø:	94.0								
		Flange depth:	4.0								
		Reference no.:		Reference no.:		Reference no.:		12033-VK500 12033-VK510 12033-VK520 12033-EB300 12033-EB30A/B A2033-VK510/20		Reference no.:	
						A2010-EC00B A2010-EC01B A2010-EC02B A2010-EC08B A2010-EC09B				12030-AD200	
NM-Motorservice Article no./ Artikelnummer/ Modelo número/ статья номер		NM-Motorservice Article no.:		NM-Motorservice Article no.:		NM-Motorservice Article no.:		NM-Motorservice Article no.:		NM-Motorservice Article no.:	
		LBS 30700 PB LBS 30700 SB		LB 30700 P LB 30700 S		KBS 30700 B		KB 30700 B		KR 30700 PB 30700	

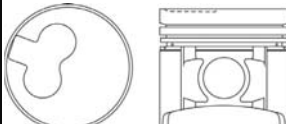

ENGINE TYPE Motor/typo/ tipo de motor/ тип двигателя	LINER KIT Liner Kit/ camisas de los cilindros/ Лайнер комплект	CYL. LINER Zylinderlaufbuchse/ camisas de los cilindros/ втулка цилиндра	PISTON + RINGS Kolben + Ringe/ Pistón + Anillos/ поршень и кольца	PISTON SET Kolben Set/ Pistón Set/ поршневой	RINGS SET Ring Set/ Anillos Set/ кольца	PIN Pin/ Perno/ Пин																																													
TD25 CABSTAR KING CAB URVAN (D21 E24 F22 F23) 1988-1994 2,494 cc 4 cyl 92.9 mm Bore Ø		<table border="1"> <tr> <td></td> <td>Liner/ Sleeve</td> <td></td> </tr> <tr> <td>Length:</td> <td>160.0</td> <td></td> </tr> <tr> <td>Outside Ø:</td> <td>95.9</td> <td></td> </tr> <tr> <td>Flange Ø:</td> <td>102.0</td> <td></td> </tr> <tr> <td>Flange depth:</td> <td>5.0</td> <td></td> </tr> </table>		Liner/ Sleeve		Length:	160.0		Outside Ø:	95.9		Flange Ø:	102.0		Flange depth:	5.0		<table border="1"> <tr> <td></td> <td>Piston</td> <td></td> </tr> <tr> <td>Length:</td> <td>87.1</td> <td></td> </tr> <tr> <td>Comp. height:</td> <td>50.3</td> <td></td> </tr> <tr> <td></td> <td>-1.5</td> <td></td> </tr> </table>		Piston		Length:	87.1		Comp. height:	50.3			-1.5			<table border="1"> <tr> <td></td> <td>Rings</td> <td></td> </tr> <tr> <td>Top:</td> <td>2.5</td> <td>Ø :</td> </tr> <tr> <td>2nd:</td> <td>2.0</td> <td>Length:</td> </tr> <tr> <td>oil:</td> <td>4.0</td> <td></td> </tr> <tr> <td></td> <td></td> <td>28.0</td> </tr> <tr> <td></td> <td></td> <td>80.5</td> </tr> </table>		Rings		Top:	2.5	Ø :	2nd:	2.0	Length:	oil:	4.0				28.0			80.5	
			Liner/ Sleeve																																																
		Length:	160.0																																																
Outside Ø:	95.9																																																		
Flange Ø:	102.0																																																		
Flange depth:	5.0																																																		
	Piston																																																		
Length:	87.1																																																		
Comp. height:	50.3																																																		
	-1.5																																																		
	Rings																																																		
Top:	2.5	Ø :																																																	
2nd:	2.0	Length:																																																	
oil:	4.0																																																		
		28.0																																																	
		80.5																																																	
		Reference no.:	Reference no.:	Reference no.:	Reference no.:	Reference no.:																																													
		11012-44G05 11012-44G10 11012-87G00		12010-44G01 12010-44G02 12010-44G11 12010-44G12	12033-44G10 A2033-44G00	12030-43G00																																													
NM-Motorservice Article no./ Artikelnummer/ Modelo número/ статья номер	NM-Motorservice Article no.:	NM-Motorservice Article no.:	NM-Motorservice Article no.:	NM-Motorservice Article no.:	NM-Motorservice Article no.:	NM-Motorservice Article no.:																																													
	LBS 30750 F LBS 30750 S LBS 30750 FA LBS 30750 SA	LB 30750 F LB 30750 S	KBS 30750 KBS 30750 A	KB 30750 KB 30750 A	KR 30750	PB 30750																																													

ENGINE TYPE Motor/typo/ tipo de motor/ тип двигателя	LINER KIT Liner Kit/ camisas de los cilindros/ Лайнер комплект	CYL. LINER Zylinderlaufbuchse/ camisas de los cilindros/ втулка цилиндра	PISTON + RINGS Kolben + Ringe/ Pistón + Anillos/ поршень и кольца	PISTON SET Kolben Set/ Pistón Set/ поршневой	RINGS SET Ring Set/ Anillos Set/ кольца	PIN Pin/ Perno/ Пин																																																
BD25 2,494 cc 4 cyl 92.9 mm Bore Ø		<table border="1"> <tr> <td></td> <td>Liner/ Sleeve</td> <td></td> </tr> <tr> <td>Length:</td> <td>160.0</td> <td></td> </tr> <tr> <td>Outside Ø:</td> <td>95.9</td> <td></td> </tr> <tr> <td>Flange Ø:</td> <td>102.0</td> <td></td> </tr> <tr> <td>Flange depth:</td> <td>5.0</td> <td></td> </tr> </table>		Liner/ Sleeve		Length:	160.0		Outside Ø:	95.9		Flange Ø:	102.0		Flange depth:	5.0		<table border="1"> <tr> <td></td> <td>Piston</td> <td></td> </tr> <tr> <td>Length:</td> <td>89.8</td> <td></td> </tr> <tr> <td>Comp. height:</td> <td>53.1</td> <td></td> </tr> <tr> <td></td> <td>-12.0</td> <td></td> </tr> <tr> <td></td> <td>-16.1</td> <td></td> </tr> </table>		Piston		Length:	89.8		Comp. height:	53.1			-12.0			-16.1		with oil gallery (= G)	<table border="1"> <tr> <td></td> <td>Rings</td> <td></td> </tr> <tr> <td>Top:</td> <td>2.5</td> <td>Ø :</td> </tr> <tr> <td>2nd:</td> <td>2.0</td> <td>Length:</td> </tr> <tr> <td>oil:</td> <td>4.0</td> <td></td> </tr> <tr> <td></td> <td></td> <td>30.0</td> </tr> <tr> <td></td> <td></td> <td>80.0</td> </tr> </table>		Rings		Top:	2.5	Ø :	2nd:	2.0	Length:	oil:	4.0				30.0			80.0	
			Liner/ Sleeve																																																			
		Length:	160.0																																																			
Outside Ø:	95.9																																																					
Flange Ø:	102.0																																																					
Flange depth:	5.0																																																					
	Piston																																																					
Length:	89.8																																																					
Comp. height:	53.1																																																					
	-12.0																																																					
	-16.1																																																					
	Rings																																																					
Top:	2.5	Ø :																																																				
2nd:	2.0	Length:																																																				
oil:	4.0																																																					
		30.0																																																				
		80.0																																																				
		Reference no.:	Reference no.:	Reference no.:	Reference no.:	Reference no.:																																																
		11012-44G05 11012-44G10 11012-87G00		12010-87G11	12033-44G00 12033-44G10 A2033-44G00	12030-31N00 12030-G2400																																																
NM-Motorservice Article no./ Artikelnummer/ Modelo número/ статья номер	NM-Motorservice Article no.:	NM-Motorservice Article no.:	NM-Motorservice Article no.:	NM-Motorservice Article no.:	NM-Motorservice Article no.:	NM-Motorservice Article no.:																																																
	LBS 30800 FG LBS 30800 SG	LB 30800 F LB 30800 S	KBS 30800 G	KB 30800 G	KR 30800	PB 30800																																																

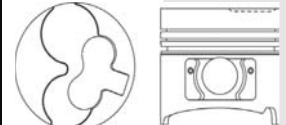
ENGINE TYPE Motor/typo/ tipo de motor/ тип двигателя	LINER KIT Liner Kit/ camisas de los cilindros/ Лайнер комплект	CYL. LINER Zylinderlaufbuchse/ camisas de los cilindros/ втулка цилиндра	PISTON + RINGS Kolben + Ringe/ Pistón + Anillos/ поршень и кольца	PISTON SET Kolben Set/ Pistón Set/ поршневой	RINGS SET Ring Set/ Anillos Set/ кольца	PIN Pin/ Perno/ Пин																																													
TD25 New KING CAB URVAN (D21 E24) 1996- 2,494 cc 4 cyl 92.9 mm Bore Ø		<table border="1"> <tr> <td></td> <td>Liner/ Sleeve</td> <td></td> </tr> <tr> <td>Length:</td> <td>160.0</td> <td></td> </tr> <tr> <td>Outside Ø:</td> <td>95.9</td> <td></td> </tr> <tr> <td>Flange Ø:</td> <td>102.0</td> <td></td> </tr> <tr> <td>Flange depth:</td> <td>5.0</td> <td></td> </tr> </table>		Liner/ Sleeve		Length:	160.0		Outside Ø:	95.9		Flange Ø:	102.0		Flange depth:	5.0		<table border="1"> <tr> <td></td> <td>Piston</td> <td></td> </tr> <tr> <td>Length:</td> <td>86.0</td> <td></td> </tr> <tr> <td>Comp. height:</td> <td>50.3</td> <td></td> </tr> <tr> <td></td> <td>-1.4</td> <td></td> </tr> </table>		Piston		Length:	86.0		Comp. height:	50.3			-1.4			<table border="1"> <tr> <td></td> <td>Rings</td> <td></td> </tr> <tr> <td>Top:</td> <td>2.5</td> <td>Ø :</td> </tr> <tr> <td>2nd:</td> <td>2.0</td> <td>Length:</td> </tr> <tr> <td>oil:</td> <td>3.0</td> <td></td> </tr> <tr> <td></td> <td></td> <td>30.0</td> </tr> <tr> <td></td> <td></td> <td>74.0</td> </tr> </table>		Rings		Top:	2.5	Ø :	2nd:	2.0	Length:	oil:	3.0				30.0			74.0	
			Liner/ Sleeve																																																
		Length:	160.0																																																
Outside Ø:	95.9																																																		
Flange Ø:	102.0																																																		
Flange depth:	5.0																																																		
	Piston																																																		
Length:	86.0																																																		
Comp. height:	50.3																																																		
	-1.4																																																		
	Rings																																																		
Top:	2.5	Ø :																																																	
2nd:	2.0	Length:																																																	
oil:	3.0																																																		
		30.0																																																	
		74.0																																																	
		Reference no.:	Reference no.:	Reference no.:	Reference no.:	Reference no.:																																													
		11012-44G05 11012-44G10 11012-87G00		12010-44G15 12010-5T105 12010-5T115	12033-5T115 12033-5T116	12030-31N00 12030-G2400																																													
NM-Motorservice Article no./ Artikelnummer/ Modelo número/ статья номер	NM-Motorservice Article no.:	NM-Motorservice Article no.:	NM-Motorservice Article no.:	NM-Motorservice Article no.:	NM-Motorservice Article no.:	NM-Motorservice Article no.:																																													
	LBS 30850 FA LBS 30850 SA	LB 30850 F LB 30850 S	KBS 30850 A	KB 30850 A	KR 30850	PB 30850																																													

ENGINE TYPE Motortyp/ tipo de motor/ тип двигателя	LINER KIT Liner Kit/ camisas de los cilindros/ Лайнер комплект	CYL. LINER Zylinderlaufbuchse/ camisas de los cilindros/ втулка цилиндра	PISTON + RINGS Kolben + Ringe/ Pistón + Anillos/ поршень и кольца	PISTON SET Kolben Set/ Pistón Set/ поршневой	RINGS SET Ring Set/ Anillos Set/ кольца	PIN Pin/ Perno/ Пин																															
TD25Ti KING CAB (D22) 1998-2001 2,494 cc 4 cyl 92.9 mm Bore Ø		<table border="1"> <tr> <td></td> <td>Liner/ Sleeve</td> <td></td> </tr> <tr> <td>Length:</td> <td>160.0</td> <td></td> </tr> <tr> <td>Outside Ø:</td> <td>95.9</td> <td></td> </tr> <tr> <td>Flange Ø:</td> <td>102.0</td> <td></td> </tr> <tr> <td>Flange depth:</td> <td>5.0</td> <td></td> </tr> </table>		Liner/ Sleeve		Length:	160.0		Outside Ø:	95.9		Flange Ø:	102.0		Flange depth:	5.0		<table border="1"> <tr> <td colspan="2">Piston</td> </tr> <tr> <td>Length:</td> <td>86.0</td> </tr> <tr> <td>Comp. height:</td> <td>50.4 -1.5</td> </tr> </table>	Piston		Length:	86.0	Comp. height:	50.4 -1.5	Alfin and with oil gallery head anodized	<table border="1"> <tr> <td colspan="2">Rings</td> </tr> <tr> <td>Top:</td> <td>2.5</td> </tr> <tr> <td>2nd: oil:</td> <td>2.0 3.0</td> </tr> </table>	Rings		Top:	2.5	2nd: oil:	2.0 3.0	<table border="1"> <tr> <td>Ø:</td> <td>30.0</td> </tr> <tr> <td>Length:</td> <td>80.0</td> </tr> </table>	Ø:	30.0	Length:	80.0
			Liner/ Sleeve																																		
Length:	160.0																																				
Outside Ø:	95.9																																				
Flange Ø:	102.0																																				
Flange depth:	5.0																																				
Piston																																					
Length:	86.0																																				
Comp. height:	50.4 -1.5																																				
Rings																																					
Top:	2.5																																				
2nd: oil:	2.0 3.0																																				
Ø:	30.0																																				
Length:	80.0																																				
		<table border="1"> <tr> <td>Reference no.:</td> <td>Reference no.:</td> <td>Reference no.:</td> <td>Reference no.:</td> <td>Reference no.:</td> </tr> <tr> <td>11012-44G05 11012-44G10 11012-87G00</td> <td></td> <td></td> <td>12010-3S900 12010-3S901 12010-3S910 12010-3S911</td> <td>12033-3S910 12033-3S911</td> </tr> </table>	Reference no.:	Reference no.:	Reference no.:	Reference no.:	Reference no.:	11012-44G05 11012-44G10 11012-87G00			12010-3S900 12010-3S901 12010-3S910 12010-3S911	12033-3S910 12033-3S911																									
Reference no.:	Reference no.:	Reference no.:	Reference no.:	Reference no.:																																	
11012-44G05 11012-44G10 11012-87G00			12010-3S900 12010-3S901 12010-3S910 12010-3S911	12033-3S910 12033-3S911																																	
NM-Motorservice Article no./ Artikelnummer/ Modelo número/ статья номер	NM-Motorservice Article no.:	NM-Motorservice Article no.:	NM-Motorservice Article no.:	NM-Motorservice Article no.:	NM-Motorservice Article no.:	NM-Motorservice Article no.:																															
	LBS 47500 FB LBS 47500 SB	LB 47500 F LB 47500 S	KBS 47500 B	KB 47500 B	KR 30900	PB 30900																															

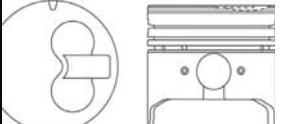





ENGINE TYPE Motortyp/ tipo de motor/ тип двигателя	LINER KIT Liner Kit/ camisas de los cilindros/ Лайнер комплект	CYL. LINER Zylinderlaufbuchse/ camisas de los cilindros/ втулка цилиндра	PISTON + RINGS Kolben + Ringe/ Pistón + Anillos/ поршень и кольца	PISTON SET Kolben Set/ Pistón Set/ поршневой	RINGS SET Ring Set/ Anillos Set/ кольца	PIN Pin/ Perno/ Пин																															
TD27 2,663 cc 4 cyl 96.0 mm Bore Ø		<table border="1"> <tr> <td></td> <td>Liner/ Sleeve</td> <td></td> </tr> <tr> <td>Length:</td> <td>160.0</td> <td></td> </tr> <tr> <td>Outside Ø:</td> <td>99.0</td> <td></td> </tr> <tr> <td>Flange Ø:</td> <td>105.0</td> <td></td> </tr> <tr> <td>Flange depth:</td> <td>5.0</td> <td></td> </tr> </table>		Liner/ Sleeve		Length:	160.0		Outside Ø:	99.0		Flange Ø:	105.0		Flange depth:	5.0		<table border="1"> <tr> <td colspan="2">Piston</td> </tr> <tr> <td>Length:</td> <td>87.0</td> </tr> <tr> <td>Comp. height:</td> <td>50.2 -1.7</td> </tr> </table>	Piston		Length:	87.0	Comp. height:	50.2 -1.7		<table border="1"> <tr> <td colspan="2">Rings</td> </tr> <tr> <td>Top:</td> <td>2.5</td> </tr> <tr> <td>2nd: oil:</td> <td>2.0 4.0</td> </tr> </table>	Rings		Top:	2.5	2nd: oil:	2.0 4.0	<table border="1"> <tr> <td>Ø:</td> <td>28.0</td> </tr> <tr> <td>Length:</td> <td>80.0</td> </tr> </table>	Ø:	28.0	Length:	80.0
			Liner/ Sleeve																																		
Length:	160.0																																				
Outside Ø:	99.0																																				
Flange Ø:	105.0																																				
Flange depth:	5.0																																				
Piston																																					
Length:	87.0																																				
Comp. height:	50.2 -1.7																																				
Rings																																					
Top:	2.5																																				
2nd: oil:	2.0 4.0																																				
Ø:	28.0																																				
Length:	80.0																																				
		<table border="1"> <tr> <td>Reference no.:</td> <td>Reference no.:</td> <td>Reference no.:</td> <td>Reference no.:</td> <td>Reference no.:</td> </tr> <tr> <td></td> <td></td> <td></td> <td>12010-10T02 12010-10T12 12010-43G02 12010-43G12</td> <td>12033-43G10 12033-43G11 12033-54T10 12033-54T11</td> </tr> </table>	Reference no.:	Reference no.:	Reference no.:	Reference no.:	Reference no.:				12010-10T02 12010-10T12 12010-43G02 12010-43G12	12033-43G10 12033-43G11 12033-54T10 12033-54T11																									
Reference no.:	Reference no.:	Reference no.:	Reference no.:	Reference no.:																																	
			12010-10T02 12010-10T12 12010-43G02 12010-43G12	12033-43G10 12033-43G11 12033-54T10 12033-54T11																																	
NM-Motorservice Article no./ Artikelnummer/ Modelo número/ статья номер	NM-Motorservice Article no.:	NM-Motorservice Article no.:	NM-Motorservice Article no.:	NM-Motorservice Article no.:	NM-Motorservice Article no.:	NM-Motorservice Article no.:																															
	LBS 30950 F LBS 30950 S LBS 30950 FA LBS 30950 SA	LB 30950 F LB 30950 S	KBS 30950 KBS 30950 A	KB 30950 KB 30950 A	KR 30950	PB 30950																															

ENGINE TYPE Motortyp/ tipo de motor/ тип двигателя	LINER KIT Liner Kit/ camisas de los cilindros/ Лайнер комплект	CYL. LINER Zylinderlaufbuchse/ camisas de los cilindros/ втулка цилиндра	PISTON + RINGS Kolben + Ringe/ Pistón + Anillos/ поршень и кольца	PISTON SET Kolben Set/ Pistón Set/ поршневой	RINGS SET Ring Set/ Anillos Set/ кольца	PIN Pin/ Perno/ Пин																															
TD27 New 2,663 cc 4 cyl 96.0 mm Bore Ø		<table border="1"> <tr> <td></td> <td>Liner/ Sleeve</td> <td></td> </tr> <tr> <td>Length:</td> <td>160.0</td> <td></td> </tr> <tr> <td>Outside Ø:</td> <td>99.0</td> <td></td> </tr> <tr> <td>Flange Ø:</td> <td>105.0</td> <td></td> </tr> <tr> <td>Flange depth:</td> <td>5.0</td> <td></td> </tr> </table>		Liner/ Sleeve		Length:	160.0		Outside Ø:	99.0		Flange Ø:	105.0		Flange depth:	5.0		<table border="1"> <tr> <td colspan="2">Piston</td> </tr> <tr> <td>Length:</td> <td>86.0</td> </tr> <tr> <td>Comp. height:</td> <td>50.3 -0.5 -1.7</td> </tr> </table>	Piston		Length:	86.0	Comp. height:	50.3 -0.5 -1.7		<table border="1"> <tr> <td colspan="2">Rings</td> </tr> <tr> <td>Top:</td> <td>2.5</td> </tr> <tr> <td>2nd: oil:</td> <td>2.0 3.0</td> </tr> </table>	Rings		Top:	2.5	2nd: oil:	2.0 3.0	<table border="1"> <tr> <td>Ø:</td> <td>30.0</td> </tr> <tr> <td>Length:</td> <td>74.0</td> </tr> </table>	Ø:	30.0	Length:	74.0
			Liner/ Sleeve																																		
Length:	160.0																																				
Outside Ø:	99.0																																				
Flange Ø:	105.0																																				
Flange depth:	5.0																																				
Piston																																					
Length:	86.0																																				
Comp. height:	50.3 -0.5 -1.7																																				
Rings																																					
Top:	2.5																																				
2nd: oil:	2.0 3.0																																				
Ø:	30.0																																				
Length:	74.0																																				
		<table border="1"> <tr> <td>Reference no.:</td> <td>Reference no.:</td> <td>Reference no.:</td> <td>Reference no.:</td> <td>Reference no.:</td> </tr> <tr> <td>11012-2S000 11012-43G00 11012-43G05 11012-43G10</td> <td></td> <td></td> <td>12010-6T000 12010-6T010</td> <td>12033-6T010 12033-6T011</td> </tr> </table>	Reference no.:	Reference no.:	Reference no.:	Reference no.:	Reference no.:	11012-2S000 11012-43G00 11012-43G05 11012-43G10			12010-6T000 12010-6T010	12033-6T010 12033-6T011																									
Reference no.:	Reference no.:	Reference no.:	Reference no.:	Reference no.:																																	
11012-2S000 11012-43G00 11012-43G05 11012-43G10			12010-6T000 12010-6T010	12033-6T010 12033-6T011																																	
NM-Motorservice Article no./ Artikelnummer/ Modelo número/ статья номер	NM-Motorservice Article no.:	NM-Motorservice Article no.:	NM-Motorservice Article no.:	NM-Motorservice Article no.:	NM-Motorservice Article no.:	NM-Motorservice Article no.:																															
	LBS 30050 FA LBS 30050 SA	LB 30050 F LB 30050 S	KBS 30050 A	KB 30050 A	KR 30050	PB 30050																															

ENGINE TYPE Motor/typo/ tipo de motor/ тип двигателя	LINER KIT Liner Kit/ camisas de los cilindros/ Лайнер комплект	CYL. LINER Zylinderlaufbuchse/ camisas de los cilindros/ втулка цилиндра	PISTON + RINGS Kolben + Ringe/ Pistón + Anillos/ поршень и кольца	PISTON SET Kolben Set/ Pistón Set/ поршневой	RINGS SET Ring Set/ Anillos Set/ кольца	PIN Pin/ Perno/ Пин																																								
TD27T TERRANO (WD21) 1989-1993 2,663 cc 4 cyl 96.0 mm Bore Ø		<table border="1"> <tr> <td></td> <td>Liner/ Sleeve</td> <td></td> </tr> <tr> <td>Length:</td> <td>160.0</td> <td></td> </tr> <tr> <td>Outside Ø:</td> <td>99.0</td> <td></td> </tr> <tr> <td>Flange Ø:</td> <td>105.0</td> <td></td> </tr> <tr> <td>Flange depth:</td> <td>5.0</td> <td></td> </tr> </table>		Liner/ Sleeve		Length:	160.0		Outside Ø:	99.0		Flange Ø:	105.0		Flange depth:	5.0		<table border="1"> <tr> <td colspan="2">Piston</td> </tr> <tr> <td>Length:</td> <td>87.0</td> </tr> <tr> <td>Comp. height:</td> <td>50.2 -0.8 -1.7</td> </tr> <tr> <td colspan="2">Reference no.:</td> </tr> </table>	Piston		Length:	87.0	Comp. height:	50.2 -0.8 -1.7	Reference no.:		Alfin and with oil gallery	<table border="1"> <tr> <td colspan="2">Rings</td> <td rowspan="2"> <table border="1"> <tr> <td>Ø:</td> <td>30.0</td> </tr> <tr> <td>Length:</td> <td>80.0</td> </tr> </table> </td> </tr> <tr> <td>Top: 2nd: oil:</td> <td>2.5 2.0 4.0</td> </tr> </table>	Rings		<table border="1"> <tr> <td>Ø:</td> <td>30.0</td> </tr> <tr> <td>Length:</td> <td>80.0</td> </tr> </table>	Ø:	30.0	Length:	80.0	Top: 2nd: oil:	2.5 2.0 4.0	<table border="1"> <tr> <td colspan="2">Reference no.:</td> </tr> <tr> <td>12033-31N11</td> <td>12030-31N00</td> </tr> <tr> <td>12033-37N10</td> <td>12030-G2400</td> </tr> <tr> <td>12033-63G10</td> <td></td> </tr> </table>	Reference no.:		12033-31N11	12030-31N00	12033-37N10	12030-G2400	12033-63G10	
				Liner/ Sleeve																																										
Length:	160.0																																													
Outside Ø:	99.0																																													
Flange Ø:	105.0																																													
Flange depth:	5.0																																													
Piston																																														
Length:	87.0																																													
Comp. height:	50.2 -0.8 -1.7																																													
Reference no.:																																														
Rings		<table border="1"> <tr> <td>Ø:</td> <td>30.0</td> </tr> <tr> <td>Length:</td> <td>80.0</td> </tr> </table>	Ø:	30.0	Length:	80.0																																								
Ø:	30.0																																													
Length:	80.0																																													
Top: 2nd: oil:	2.5 2.0 4.0																																													
Reference no.:																																														
12033-31N11	12030-31N00																																													
12033-37N10	12030-G2400																																													
12033-63G10																																														
		<table border="1"> <tr> <td colspan="2">Reference no.:</td> </tr> <tr> <td>11012-2S000</td> <td>12010-05D00</td> </tr> <tr> <td>11012-43G00</td> <td>12010-05D10</td> </tr> <tr> <td>11012-43G05</td> <td>12010-31N02</td> </tr> <tr> <td>11012-43G10</td> <td>12010-31N03</td> </tr> <tr> <td></td> <td>12010-31N12</td> </tr> <tr> <td></td> <td>12010-31N13</td> </tr> </table>	Reference no.:		11012-2S000	12010-05D00	11012-43G00	12010-05D10	11012-43G05	12010-31N02	11012-43G10	12010-31N03		12010-31N12		12010-31N13	<table border="1"> <tr> <td colspan="2">Reference no.:</td> </tr> <tr> <td>12010-10T05</td> <td></td> </tr> </table>	Reference no.:		12010-10T05																										
Reference no.:																																														
11012-2S000	12010-05D00																																													
11012-43G00	12010-05D10																																													
11012-43G05	12010-31N02																																													
11012-43G10	12010-31N03																																													
	12010-31N12																																													
	12010-31N13																																													
Reference no.:																																														
12010-10T05																																														
NM-Motorservice Article no./ Artikelnummer/ Modelo número/ статья номер	NM-Motorservice Article no.:	NM-Motorservice Article no.:	NM-Motorservice Article no.:	NM-Motorservice Article no.:	NM-Motorservice Article no.:	NM-Motorservice Article no.:																																								
	LBS 31050 FB LBS 31050 SB	LB 31050 F LB 31050 S	KBS 31050 B	KB 31050 B	KR 31050	PB 31050																																								

ENGINE TYPE Motor/typo/ tipo de motor/ тип двигателя	LINER KIT Liner Kit/ camisas de los cilindros/ Лайнер комплект	CYL. LINER Zylinderlaufbuchse/ camisas de los cilindros/ втулка цилиндра	PISTON + RINGS Kolben + Ringe/ Pistón + Anillos/ поршень и кольца	PISTON SET Kolben Set/ Pistón Set/ поршневой	RINGS SET Ring Set/ Anillos Set/ кольца	PIN Pin/ Perno/ Пин																																										
BD30 FORKLIFT (J02) 1993-1996 2,953 cc 4 cyl 96.0 mm Bore Ø		<table border="1"> <tr> <td></td> <td>Liner/ Sleeve</td> <td></td> </tr> <tr> <td>Length:</td> <td>170.0</td> <td></td> </tr> <tr> <td>Outside Ø:</td> <td>99.0</td> <td></td> </tr> <tr> <td>Flange Ø:</td> <td>105.0</td> <td></td> </tr> <tr> <td>Flange depth:</td> <td>5.0</td> <td></td> </tr> </table>		Liner/ Sleeve		Length:	170.0		Outside Ø:	99.0		Flange Ø:	105.0		Flange depth:	5.0		<table border="1"> <tr> <td colspan="2">Piston</td> </tr> <tr> <td>Length:</td> <td>89.6</td> </tr> <tr> <td>Comp. height:</td> <td>53.1 -15.2 -20.1</td> </tr> <tr> <td colspan="2">Reference no.:</td> </tr> </table>	Piston		Length:	89.6	Comp. height:	53.1 -15.2 -20.1	Reference no.:		Alfin and with oil gallery	<table border="1"> <tr> <td colspan="2">Rings</td> <td rowspan="2"> <table border="1"> <tr> <td>Ø:</td> <td>30.0</td> </tr> <tr> <td>Length:</td> <td>80.0</td> </tr> </table> </td> </tr> <tr> <td>Top: 2nd: oil:</td> <td>2.5 2.0 4.0</td> </tr> </table>	Rings		<table border="1"> <tr> <td>Ø:</td> <td>30.0</td> </tr> <tr> <td>Length:</td> <td>80.0</td> </tr> </table>	Ø:	30.0	Length:	80.0	Top: 2nd: oil:	2.5 2.0 4.0	<table border="1"> <tr> <td colspan="2">Reference no.:</td> </tr> <tr> <td>12033-43G10</td> <td>12030-31N00</td> </tr> <tr> <td>12033-43G11</td> <td>12030-G2400</td> </tr> <tr> <td>12033-54T10</td> <td></td> </tr> <tr> <td>12033-54T11</td> <td></td> </tr> </table>	Reference no.:		12033-43G10	12030-31N00	12033-43G11	12030-G2400	12033-54T10		12033-54T11	
				Liner/ Sleeve																																												
Length:	170.0																																															
Outside Ø:	99.0																																															
Flange Ø:	105.0																																															
Flange depth:	5.0																																															
Piston																																																
Length:	89.6																																															
Comp. height:	53.1 -15.2 -20.1																																															
Reference no.:																																																
Rings		<table border="1"> <tr> <td>Ø:</td> <td>30.0</td> </tr> <tr> <td>Length:</td> <td>80.0</td> </tr> </table>	Ø:	30.0	Length:	80.0																																										
Ø:	30.0																																															
Length:	80.0																																															
Top: 2nd: oil:	2.5 2.0 4.0																																															
Reference no.:																																																
12033-43G10	12030-31N00																																															
12033-43G11	12030-G2400																																															
12033-54T10																																																
12033-54T11																																																
		<table border="1"> <tr> <td colspan="2">Reference no.:</td> </tr> <tr> <td>11012-54T00</td> <td></td> </tr> </table>	Reference no.:		11012-54T00		<table border="1"> <tr> <td colspan="2">Reference no.:</td> </tr> <tr> <td>12010-54T00</td> <td></td> </tr> <tr> <td>12010-54T01</td> <td></td> </tr> <tr> <td>12010-54T10</td> <td></td> </tr> <tr> <td>12010-54T11</td> <td></td> </tr> <tr> <td>12010-54T60</td> <td></td> </tr> <tr> <td>12010-54T61</td> <td></td> </tr> </table>	Reference no.:		12010-54T00		12010-54T01		12010-54T10		12010-54T11		12010-54T60		12010-54T61																												
Reference no.:																																																
11012-54T00																																																
Reference no.:																																																
12010-54T00																																																
12010-54T01																																																
12010-54T10																																																
12010-54T11																																																
12010-54T60																																																
12010-54T61																																																
NM-Motorservice Article no./ Artikelnummer/ Modelo número/ статья номер	NM-Motorservice Article no.:	NM-Motorservice Article no.:	NM-Motorservice Article no.:	NM-Motorservice Article no.:	NM-Motorservice Article no.:	NM-Motorservice Article no.:																																										
	LBS 31100 FB LBS 31100 SB	LB 31100 F LB 31100 S	KBS 31100 B	KB 31100 B	KR 31100	PB 31100																																										

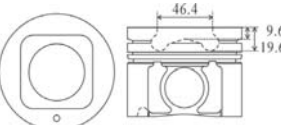

ENGINE TYPE Motor/typo/ tipo de motor/ тип двигателя	LINER KIT Liner Kit/ camisas de los cilindros/ Лайнер комплект	CYL. LINER Zylinderlaufbuchse/ camisas de los cilindros/ втулка цилиндра	PISTON + RINGS Kolben + Ringe/ Pistón + Anillos/ поршень и кольца	PISTON SET Kolben Set/ Pistón Set/ поршневой	RINGS SET Ring Set/ Anillos Set/ кольца	PIN Pin/ Perno/ Пин																																						
TD27T 2,663 cc 4 cyl 96.0 mm Bore Ø		<table border="1"> <tr> <td></td> <td>Liner/ Sleeve</td> <td></td> </tr> <tr> <td>Length:</td> <td>160.0</td> <td></td> </tr> <tr> <td>Outside Ø:</td> <td>99.0</td> <td></td> </tr> <tr> <td>Flange Ø:</td> <td>105.0</td> <td></td> </tr> <tr> <td>Flange depth:</td> <td>5.0</td> <td></td> </tr> </table>		Liner/ Sleeve		Length:	160.0		Outside Ø:	99.0		Flange Ø:	105.0		Flange depth:	5.0		<table border="1"> <tr> <td colspan="2">Piston</td> </tr> <tr> <td>Length:</td> <td>86.0</td> </tr> <tr> <td>Comp. height:</td> <td>50.1 -1.8</td> </tr> <tr> <td colspan="2">Reference no.:</td> </tr> </table>	Piston		Length:	86.0	Comp. height:	50.1 -1.8	Reference no.:			<table border="1"> <tr> <td colspan="2">Rings</td> <td rowspan="2"> <table border="1"> <tr> <td>Ø:</td> <td>30.0</td> </tr> <tr> <td>Length:</td> <td>74.0</td> </tr> </table> </td> </tr> <tr> <td>Top: 2nd: oil:</td> <td>2.5 2.0 3.0</td> </tr> </table>	Rings		<table border="1"> <tr> <td>Ø:</td> <td>30.0</td> </tr> <tr> <td>Length:</td> <td>74.0</td> </tr> </table>	Ø:	30.0	Length:	74.0	Top: 2nd: oil:	2.5 2.0 3.0	<table border="1"> <tr> <td colspan="2">Reference no.:</td> </tr> <tr> <td>12033-6T010</td> <td>12030-31N00</td> </tr> <tr> <td>12033-6T011</td> <td>12030-G2400</td> </tr> </table>	Reference no.:		12033-6T010	12030-31N00	12033-6T011	12030-G2400
				Liner/ Sleeve																																								
Length:	160.0																																											
Outside Ø:	99.0																																											
Flange Ø:	105.0																																											
Flange depth:	5.0																																											
Piston																																												
Length:	86.0																																											
Comp. height:	50.1 -1.8																																											
Reference no.:																																												
Rings		<table border="1"> <tr> <td>Ø:</td> <td>30.0</td> </tr> <tr> <td>Length:</td> <td>74.0</td> </tr> </table>	Ø:	30.0	Length:	74.0																																						
Ø:	30.0																																											
Length:	74.0																																											
Top: 2nd: oil:	2.5 2.0 3.0																																											
Reference no.:																																												
12033-6T010	12030-31N00																																											
12033-6T011	12030-G2400																																											
		<table border="1"> <tr> <td colspan="2">Reference no.:</td> </tr> <tr> <td>11012-2S000</td> <td></td> </tr> <tr> <td>11012-43G00</td> <td></td> </tr> <tr> <td>11012-43G05</td> <td></td> </tr> <tr> <td>11012-43G10</td> <td></td> </tr> </table>	Reference no.:		11012-2S000		11012-43G00		11012-43G05		11012-43G10		<table border="1"> <tr> <td colspan="2">Reference no.:</td> </tr> <tr> <td>12010-10T05</td> <td></td> </tr> </table>	Reference no.:		12010-10T05																												
Reference no.:																																												
11012-2S000																																												
11012-43G00																																												
11012-43G05																																												
11012-43G10																																												
Reference no.:																																												
12010-10T05																																												
NM-Motorservice Article no./ Artikelnummer/ Modelo número/ статья номер	NM-Motorservice Article no.:	NM-Motorservice Article no.:	NM-Motorservice Article no.:	NM-Motorservice Article no.:	NM-Motorservice Article no.:	NM-Motorservice Article no.:																																						
	LBS 31150 FA LBS 31150 SA	LB 31150 F LB 31150 S	KBS 31150 A	KB 31150 A	KR 31150	PB 31150																																						

ENGINE TYPE Motortyp/ tipo de motor/ тип двигателя	LINER KIT Liner Kit/ camisas de los cilindros/ Лайнер комплект	CYL. LINER Zylinderlaufbuchse/ camisas de los cilindros/ втулка цилиндра		PISTON + RINGS Kolben + Ringe/ Pistón + Anillos/ поршень и кольца	PISTON SET Kolben Set/ Pistón Set/ поршневой	RINGS SET Ring Set/ Anillos Set/ кольца	PIN Pin/ Perno/ Пин	
TD27Ti New TERRANO 2 (R20) 1996-2004 2,664 cc 4 cyl 96.0 mm Bore Ø			Liner/ Sleeve	Piston Length: 74.0 Comp. height: 50.5 -1.5	Alfin and with oil gallery head anodized skirt MOS2 treated	Rings Top: 2.5 2nd: 2.0 oil: 3.0	Ø: 30.0 Length: 79.8	
		Length: 160.0 Outside Ø: 99.0 Flange Ø: 105.0 Flange depth: 5.0						
		Reference no.:	Reference no.:	Reference no.:	Reference no.:	Reference no.:	Reference no.:	Reference no.:
		11012-2S000 11012-43G00 11012-43G05 11012-43G10			12010-7F406 12010-7F411 12010-7F412 12010-7F413 A2010-7F406 A2010-7F407/8	12033-0W813 12033-0W814 12033-0W81A 12033-2W211 12033-7F400 12033-NA010	12030-31N00 12030-G2400	
NM-Motorservice Article no./ Artikelnummer/ Modelo número/ статья номер	NM-Motorservice Article no.:	NM-Motorservice Article no.:	NM-Motorservice Article no.:	NM-Motorservice Article no.:	NM-Motorservice Article no.:	NM-Motorservice Article no.:	NM-Motorservice Article no.:	
	LBS 83000 FB LBS 83000 SB	LB 83000 F LB 83000 S		KBS 83000 B	KB 83000 B	KR 83000	PB 83000	
BD30T 2,953 cc 4 cyl 96.0 mm Bore Ø			Liner/ Sleeve	Piston Length: 89.6 Comp. height: 53.0 -9.0 -21.2	Alfin and with oil gallery	Rings Top: 2.5 2nd: 2.0 oil: 3.0	Ø: 30.0 Length: 80.0	
		Length: 170.0 Outside Ø: 99.0 Flange Ø: 105.0 Flange depth: 5.0						
		Reference no.:	Reference no.:	Reference no.:	Reference no.:	Reference no.:	Reference no.:	Reference no.:
		11012-54T00			12010-69T05 12010-69T06	12033-0W813 12033-0W814 12033-0W81A 12033-2W211 12033-7F400 12033-NA010	12030-31N00 12030-G2400	
NM-Motorservice Article no./ Artikelnummer/ Modelo número/ статья номер	NM-Motorservice Article no.:	NM-Motorservice Article no.:	NM-Motorservice Article no.:	NM-Motorservice Article no.:	NM-Motorservice Article no.:	NM-Motorservice Article no.:	NM-Motorservice Article no.:	
	LBS 31250 FB LBS 31250 SB	LB 31250 F LB 31250 S		KBS 31250 B	KB 31250 B	KR 31250	PB 31250	
ZD30 ZD30DDTi PATROL(GR) TERRANO 2 (R20 Y61) 2000-2006 2,953 cc 4 cyl 96.0 mm Bore Ø			Flanged	No flange	Piston Length: 74.1 Comp. height: 50.1 -9.6 -19.6	Alfin and with oil gallery head anodized	Rings Top: 2.5 2nd: 2.0 oil: 3.0	Ø: 33.0 Length: 78.0
		Length: 165.0 Outside Ø: 100.0 Flange Ø: 104.0 Flange depth: 5.0	160.0 100.0					
		Reference no.:	Reference no.:	Reference no.:	Reference no.:	Reference no.:	Reference no.:	Reference no.:
					12010-VC101 12010-VC102 12010-VD112 12010-VK600 12010-VX201	12033-0W813 12033-0W814 12033-0W81A 12033-2W211 12033-7F400 12033-NA010	12030-1W400 12030-2W200	
NM-Motorservice Article no./ Artikelnummer/ Modelo número/ статья номер	NM-Motorservice Article no.:	NM-Motorservice Article no.:	NM-Motorservice Article no.:	NM-Motorservice Article no.:	NM-Motorservice Article no.:	NM-Motorservice Article no.:	NM-Motorservice Article no.:	
	LBS 16000 PB LBS 16000 SB	LB 16000 P LB 16000 S		KBS 16000 B	KB 16000 B	KR 16000	PB 16000	

ENGINE TYPE Motor/тип de motor/ тип двигателя	LINER KIT Liner Kit/ camisas de los cilindros/ Лайнер комплект	CYL. LINER Zylinderlaufbuchse/ camisas de los cilindros/ втулка цилиндра		PISTON + RINGS Kolben + Ringe/ Pistón + Anillos/ поршень и кольца		PISTON SET Kolben Set/ Pistón Set/ поршневой	RINGS SET Ring Set/ Anillos Set/ кольца		PIN Pin/ Perno/ Пин	
ZD30 ZD30DDTi PATROL(GR) TERRANO 2 (R20 Y61) 2000-2006 2,953 cc 4 cyl 96.0 mm Bore Ø			No flange	Piston		Alfin and with oil gallery head anodized	Rings		Ø : 33.0 Length: 78.0	
		Length: 165.0 Outside Ø: 100.0 Flange Ø: 104.0 Flange depth: 5.0	160.0 100.0	Length: 74.1 Comp. height: 50.1 -9.6 -19.6	Top: 2.5 2nd: 2.0 oil: 2.0					
		Reference no.:		Reference no.:		Reference no.:	Reference no.:		Reference no.:	
						12010-VC111 12010-VC112 12010-VK610 12010-VX211	12033-DB010 12033-VK610		12030-1W400 12030-2W200	
NM-Motorservice Article no./ Artikelnummer/ Modelo нúmero/ статья номер	NM-Motorservice Article no.:	NM-Motorservice Article no.:		NM-Motorservice Article no.:		NM-Motorservice Article no.:	NM-Motorservice Article no.:		NM-Motorservice Article no.:	
	LBS 31350 PB LBS 31350 SB	LB 31350 P LB 31350 S		KBS 31350 B		KB 31350 B	KR 31350		PB 31350	

ENGINE TYPE Motor/тип de motor/ тип двигателя	LINER KIT Liner Kit/ camisas de los cilindros/ Лайнер комплект	CYL. LINER Zylinderlaufbuchse/ camisas de los cilindros/ втулка цилиндра		PISTON + RINGS Kolben + Ringe/ Pistón + Anillos/ поршень и кольца		PISTON SET Kolben Set/ Pistón Set/ поршневой	RINGS SET Ring Set/ Anillos Set/ кольца		PIN Pin/ Perno/ Пин	
ZD30DDTi CABSTAR PATROL(GR) (F24M Y61) 2006- 2,953 cc 4 cyl 96.0 mm Bore Ø			No flange	Piston		Alfin and with oil gallery	Rings		Ø : 33.0 Length: 78.0	
		Length: 165.0 Outside Ø: 100.0 Flange Ø: 104.0 Flange depth: 5.0	160.0 100.0	Length: 78.1 Comp. height: 50.1 -8.7 -18.2	Top: 2.5 2nd: 2.0 oil: 2.0					
		Reference no.:		Reference no.:		Reference no.:	Reference no.:		Reference no.:	
						12010-DB000 12010-DB010	12033-DB010 12033-VK610		12030-1W400 12030-2W200	
NM-Motorservice Article no./ Artikelnummer/ Modelo нúmero/ статья номер	NM-Motorservice Article no.:	NM-Motorservice Article no.:		NM-Motorservice Article no.:		NM-Motorservice Article no.:	NM-Motorservice Article no.:		NM-Motorservice Article no.:	
	LBS 48500 APB LBS 48500 ASB	LB 48500 P LB 48500 S		KBS 48500 AB		KB 48500 AB	KR 48500		PB 48500	



ENGINE TYPE Motor/тип de motor/ тип двигателя	LINER KIT Liner Kit/ camisas de los cilindros/ Лайнер комплект	CYL. LINER Zylinderlaufbuchse/ camisas de los cilindros/ втулка цилиндра		PISTON + RINGS Kolben + Ringe/ Pistón + Anillos/ поршень и кольца		PISTON SET Kolben Set/ Pistón Set/ поршневой	RINGS SET Ring Set/ Anillos Set/ кольца		PIN Pin/ Perno/ Пин	
TD27T New 2,664 cc 4 cyl 96.0 mm Bore Ø			Liner/ Sleeve	Piston		Alfin and with oil gallery	Rings		Ø : 30.0 Length: 80.0	
		Length: 160.0 Outside Ø: 99.0 Flange Ø: 105.0 Flange depth: 5.0		Length: 87.0 Comp. height: 50.3 -2.0	Top: 2.5 2nd: 2.0 oil: 4.0					
		Reference no.:		Reference no.:		Reference no.:	Reference no.:		Reference no.:	
		11012-43G00 11012-43G05 11012-43G10 11012-2S000				12010-63G01 12010-63G11	12033-31N11 12033-37N10 12033-63G10		12030-31N00 12030-G2400	
NM-Motorservice Article no./ Artikelnummer/ Modelo нúmero/ статья номер	NM-Motorservice Article no.:	NM-Motorservice Article no.:		NM-Motorservice Article no.:		NM-Motorservice Article no.:	NM-Motorservice Article no.:		NM-Motorservice Article no.:	
	LBS 31450 FB LBS 31450 SB	LB 31450 F LB 31450 S		KBS 31450 B		KB 31450 B	KR 31450		PB 31450	



ENGINE TYPE Motortyp/ tipo de motor/ тип двигателя	LINER KIT Liner Kit/ camisas de los cilindros/ Лайнер комплект	CYL. LINER Zylinderlaufbuchse/ camisas de los cilindros/ втулка цилиндра		PISTON + RINGS Kolben + Ringe/ Pistón + Anillos/ поршень и кольца	PISTON SET Kolben Set/ Pistón Set/ поршневой	RINGS SET Ring Set/ Anillos Set/ кольца	PIN Pin/ Perno/ Пин
TD27Ti also for FORD TD27T 2,664 cc 4 cyl 96.0 mm Bore Ø		Liner/ Sleeve	Piston	Length: 87.2 Comp. height: 50.4 -1.4	Alfin and with oil gallery head anodized skirt MOS2 treated	Rings	Top: 2.5 2nd: 2.0 oil: 3.0 Ø: 30.0 Length: 80.0
		11012-43G00 11012-43G05 11012-43G10 11012-2S000		12033-0W813 12033-0W814 12033-0W81A 12033-2W211 12033-7F400 12033-NA010	12030-31N00 12030-G2400		
NM-Motorservice Article no./ Artikelnummer/ Modelo número/ статья номер	NM-Motorservice Article no.:	NM-Motorservice Article no.:	NM-Motorservice Article no.:	NM-Motorservice Article no.:	NM-Motorservice Article no.:	NM-Motorservice Article no.:	NM-Motorservice Article no.:
	LBS 83000 CFB LBS 83000 CSB	LB 83000 F LB 83000 S		KBS 83000 CB	KB 83000 CB	KR 83000	PB 83000
ZD30DD URVAN (E25) 2,953 cc 4 cyl 96.0 mm Bore Ø		Flanged	No flange	Piston	Alfin and with oil gallery	Rings	Top: 2.0 2nd: 1.2 oil: 2.0 Ø: 33.0 Length: 78.0
		12010-VW200 12010-VW210 12010-VW211B		12033-VW211	12030-1W400 12030-2W200		
NM-Motorservice Article no./ Artikelnummer/ Modelo número/ статья номер	NM-Motorservice Article no.:	NM-Motorservice Article no.:	NM-Motorservice Article no.:	NM-Motorservice Article no.:	NM-Motorservice Article no.:	NM-Motorservice Article no.:	NM-Motorservice Article no.:
	LBS 31550 PB LBS 31550 SB	LB 31550 P LB 31550 S		KBS 31550 B	KB 31550 B	KR 31550	PB 31550
BD30Ti CABSTAR 3.0 TDI 1998- 2,953 cc 4 cyl 96.0 mm Bore Ø		Liner/ Sleeve	Piston	Length: 89.5 Comp. height: 53.2 -8.6 -20.3	Alfin skirt MOS2 treated	Rings	Top: 2.5 2nd: 2.0 oil: 3.0 Ø: 30.0 Length: 80.0
		11012-54T00		12033-0W813 12033-0W814 12033-0W81A 12033-2W211 12033-7F400 12033-NA010	12030-31N00 12030-G2400		
NM-Motorservice Article no./ Artikelnummer/ Modelo número/ статья номер	NM-Motorservice Article no.:	NM-Motorservice Article no.:	NM-Motorservice Article no.:	NM-Motorservice Article no.:	NM-Motorservice Article no.:	NM-Motorservice Article no.:	NM-Motorservice Article no.:
	LBS 31600 FA LBS 31600 SA	LB 31600 F LB 31600 S		KBS 31600 A	KB 31600 A	KR 31600	PB 31600



ENGINE TYPE Motortyp/ tipo de motor/ тип двигателя	LINER KIT Liner Kit/ camisas de los cilindros/ Лайнер комплект	CYL. LINER Zylinderlaufbuchse/ camisas de los cilindros/ втулка цилиндра		PISTON + RINGS Kolben + Ringe/ Pistón + Anillos/ поршень и кольца		PISTON SET Kolben Set/ Pistón Set/ поршневой	RINGS SET Ring Set/ Anillos Set/ кольца		PIN Pin/ Perno/ Пин	
ED30 4 Rings		Liner/ Sleeve	Piston	Rings	Reference no.:	Reference no.:	Reference no.:	Reference no.:	Reference no.:	Reference no.:
2,956 cc 4 cyl 98.0 mm Bore Ø										
NM-Motorservice Article no./ Artikelnummer/ Modelo número/ статья номер	NM-Motorservice Article no.:	NM-Motorservice Article no.:	NM-Motorservice Article no.:	NM-Motorservice Article no.:	NM-Motorservice Article no.:	NM-Motorservice Article no.:	NM-Motorservice Article no.:	NM-Motorservice Article no.:	NM-Motorservice Article no.:	NM-Motorservice Article no.:
	LBS 31650 F	LB 31650 F	KBS 31650	KB 31650	KR 31650	PB 31650				

ENGINE TYPE Motortyp/ tipo de motor/ тип двигателя	LINER KIT Liner Kit/ camisas de los cilindros/ Лайнер комплект	CYL. LINER Zylinderlaufbuchse/ camisas de los cilindros/ втулка цилиндра		PISTON + RINGS Kolben + Ringe/ Pistón + Anillos/ поршень и кольца		PISTON SET Kolben Set/ Pistón Set/ поршневой	RINGS SET Ring Set/ Anillos Set/ кольца		PIN Pin/ Perno/ Пин	
ED30 3 Rings		Liner/ Sleeve	Piston	Rings	Reference no.:	Reference no.:	Reference no.:	Reference no.:	Reference no.:	Reference no.:
2,956 cc 4 cyl 98.0 mm Bore Ø										
NM-Motorservice Article no./ Artikelnummer/ Modelo número/ статья номер	NM-Motorservice Article no.:	NM-Motorservice Article no.:	NM-Motorservice Article no.:	NM-Motorservice Article no.:	NM-Motorservice Article no.:	NM-Motorservice Article no.:	NM-Motorservice Article no.:	NM-Motorservice Article no.:	NM-Motorservice Article no.:	NM-Motorservice Article no.:
	LBS 31700 F	LB 31700 F	KBS 31700	KB 31700	KR 31700	PB 31700				

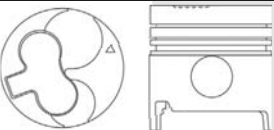
ENGINE TYPE Motortyp/ tipo de motor/ тип двигателя	LINER KIT Liner Kit/ camisas de los cilindros/ Лайнер комплект	CYL. LINER Zylinderlaufbuchse/ camisas de los cilindros/ втулка цилиндра			PISTON + RINGS Kolben + Ringe/ Pistón + Anillos/ поршень и кольца		PISTON SET Kolben Set/ Pistón Set/ поршневой	RINGS SET Ring Set/ Anillos Set/ кольца		PIN Pin/ Perno/ Пин	
QD32		Flanged	No flange	Piston	Rings	Reference no.:	Reference no.:	Reference no.:	Reference no.:	Reference no.:	Reference no.:
3,153 cc 4 cyl 99.2 mm Bore Ø											
NM-Motorservice Article no./ Artikelnummer/ Modelo número/ статья номер	NM-Motorservice Article no.:	NM-Motorservice Article no.:	NM-Motorservice Article no.:	NM-Motorservice Article no.:	NM-Motorservice Article no.:	NM-Motorservice Article no.:	NM-Motorservice Article no.:	NM-Motorservice Article no.:	NM-Motorservice Article no.:	NM-Motorservice Article no.:	NM-Motorservice Article no.:
	LBS 31750 PA LBS 31750 SA	LB 31750 P LB 31750 S	KBS 31750 A	KB 31750 A	KR 31750	PB 31750					

ENGINE TYPE Motortyp/ tipo de motor/ тип двигателя	LINER KIT Liner Kit/ camisas de los cilindros/ Лайнер комплект	CYL. LINER Zylinderlaufbuchse/ camisas de los cilindros/ втулка цилиндра		PISTON + RINGS Kolben + Ringe/ Pistón + Anillos/ поршень и кольца	PISTON SET Kolben Set/ Pistón Set/ поршневой	RINGS SET Ring Set/ Anillos Set/ кольца	PIN Pin/ Perno/ Пин	
QD32Ti 3,153 cc 4 cyl 99.2 mm Bore Ø			Flanged	No flange	Piston	Alfin and with oil gallery head anodized	Rings	Ø : 33.0 Length: 79.0
		Length: 160.0 Outside Ø: 103.2 Flange Ø: 107.0 Flange depth: 5.0	155.0 103.2	Length: 69.8 Comp. height: 45.3 -1.5 -2.6				
		Reference no.:		Reference no.:	Reference no.:	Reference no.:	Reference no.:	
		11012-2S611			12010-2S615	12033-1W411	12030-1W400 12030-2W200	
NM-Motorservice Article no./ Artikelnummer/ Modelo número/ статья номер	NM-Motorservice Article no.:	NM-Motorservice Article no.:		NM-Motorservice Article no.:	NM-Motorservice Article no.:	NM-Motorservice Article no.:	NM-Motorservice Article no.:	
	LBS 31800 PB LBS 31800 SB	LB 31800 P LB 31800 S		KBS 31800 B	KB 31800 B	KR 31800	PB 31800	

ENGINE TYPE Motortyp/ tipo de motor/ тип двигателя	LINER KIT Liner Kit/ camisas de los cilindros/ Лайнер комплект	CYL. LINER Zylinderlaufbuchse/ camisas de los cilindros/ втулка цилиндра		PISTON + RINGS Kolben + Ringe/ Pistón + Anillos/ поршень и кольца	PISTON SET Kolben Set/ Pistón Set/ поршневой	RINGS SET Ring Set/ Anillos Set/ кольца	PIN Pin/ Perno/ Пин
ED33 3,298 cc 4 cyl 100.0 mm Bore Ø			Liner/ Sleeve	Piston		Rings	Ø : 34.0 Length: 84.0
		Length: 191.0 Outside Ø: 112.0 Flange Ø: 118.0 Flange depth: 8.0 +1.0					
		Reference no.:		Reference no.:	Reference no.:	Reference no.:	Reference no.:
		11012-T9000 11012-T9001			12010-J6500 12010-J6501 12010-T9000 12010-T9001 12010-T9010 12010-T9020	12033-J6500 12033-J6501 12033-J9000 12033-T9000 12033-T9304 12033-Z5004	12030-Z5000
NM-Motorservice Article no./ Artikelnummer/ Modelo número/ статья номер	NM-Motorservice Article no.:	NM-Motorservice Article no.:		NM-Motorservice Article no.:	NM-Motorservice Article no.:	NM-Motorservice Article no.:	NM-Motorservice Article no.:
	LBS 31850 F	LB 31850 F		KBS 31850	KB 31850	KR 31850	PB 31850

ENGINE TYPE Motortyp/ tipo de motor/ тип двигателя	LINER KIT Liner Kit/ camisas de los cilindros/ Лайнер комплект	CYL. LINER Zylinderlaufbuchse/ camisas de los cilindros/ втулка цилиндра		PISTON + RINGS Kolben + Ringe/ Pistón + Anillos/ поршень и кольца	PISTON SET Kolben Set/ Pistón Set/ поршневой	RINGS SET Ring Set/ Anillos Set/ кольца	PIN Pin/ Perno/ Пин
ED33 New 3,298 cc 4 cyl 100.0 mm Bore Ø			Liner/ Sleeve	Piston		Rings	Ø : 34.0 Length: 85.0
		Length: 191.0 Outside Ø: 113.0 Flange Ø: 119.0 Flange depth: 8.0 +1.0					
		Reference no.:		Reference no.:	Reference no.:	Reference no.:	Reference no.:
		11012-02T01 11012-02T10 11012-T9017		O-Ring: 11018-01T00 11018-01T01		12033-T9303 12033-W4200 12033-T9306	12030-Z5000
NM-Motorservice Article no./ Artikelnummer/ Modelo número/ статья номер	NM-Motorservice Article no.:	NM-Motorservice Article no.:		NM-Motorservice Article no.:	NM-Motorservice Article no.:	NM-Motorservice Article no.:	NM-Motorservice Article no.:
	LBS 31900 FA	LB 31900 F		KBS 31900 A	KB 31900 A	KR 31900	PB 31900

ENGINE TYPE Motortyp/ tipo de motor/ тип двигателя	LINER KIT Liner Kit/ camisas de los cilindros/ Лайнер комплект	CYL. LINER Zylinderlaufbuchse/ camisas de los cilindros/ втулка цилиндра	PISTON + RINGS Kolben + Ringe/ Pistón + Anillos/ поршень и кольца	PISTON SET Kolben Set/ Pistón Set/ поршневой	RINGS SET Ring Set/ Anillos Set/ кольца	PIN Pin/ Perno/ Пин
FD33 3,298 cc 4 cyl 100.0 mm Bore Ø		Liner/ Sleeve	Piston		Rings	
		Length: 191.0 Outside Ø: 113.0 Flange Ø: 119.0 Flange depth: 8.0 +1.0	Length: 103.2 Comp. height: 59.2 -8.0 -20.9	Top: 3.0 2nd: 2.0 oil: 4.5	Ø: 34.0 Length: 85.0	
		Reference no.:	Reference no.:	Reference no.:	12033-J6500 12033-J6501 12033-J9000 12033-T9000 12033-T9304 12033-Z5004	Reference no.:
		11012-02T01 11012-02T10 11012-T9017	O-Ring: 11018-01T00 11018-01T01	12010-T9313 12011-T9313		12030-Z5000
NM-Motorservice Article no./ Artikelnummer/ Modelo número/ статья номер	NM-Motorservice Article no.:	NM-Motorservice Article no.:	NM-Motorservice Article no.:	NM-Motorservice Article no.:	NM-Motorservice Article no.:	NM-Motorservice Article no.:
	LBS 31950 FA	LB 31950 F	KBS 31950 A	KB 31950 A	KR 31950	PB 31950

ENGINE TYPE Motortyp/ tipo de motor/ тип двигателя	LINER KIT Liner Kit/ camisas de los cilindros/ Лайнер комплект	CYL. LINER Zylinderlaufbuchse/ camisas de los cilindros/ втулка цилиндра	PISTON + RINGS Kolben + Ringe/ Pistón + Anillos/ поршень и кольца	PISTON SET Kolben Set/ Pistón Set/ поршневой	RINGS SET Ring Set/ Anillos Set/ кольца	PIN Pin/ Perno/ Пин
FD33T 3,298 cc 4 cyl 100.0 mm Bore Ø		Liner/ Sleeve	Piston		Rings	
		Length: 191.0 Outside Ø: 113.0 Flange Ø: 119.0 Flange depth: 8.0 +1.0	Length: 103.2 Comp. height: 59.2 -8.0 -20.9	Top: 3.0 2nd: 2.0 oil: 4.5	Ø: 34.0 Length: 85.0	
		Reference no.:	Reference no.:	Reference no.:	Reference no.:	Reference no.:
		11012-02T01 11012-02T10 11012-T9017	O-Ring: 11018-01T00 11018-01T01	12010-T9300	12033-T9302 12033-T9307 12033-T9308	12030-Z5000
NM-Motorservice Article no./ Artikelnummer/ Modelo número/ статья номер	NM-Motorservice Article no.:	NM-Motorservice Article no.:	NM-Motorservice Article no.:	NM-Motorservice Article no.:	NM-Motorservice Article no.:	NM-Motorservice Article no.:
	LBS 21650 FA	LB 21650 F	KBS 21650 A	KB 21650 A	KR 21650	PB 21650

ENGINE TYPE Motortyp/ tipo de motor/ тип двигателя	LINER KIT Liner Kit/ camisas de los cilindros/ Лайнер комплект	CYL. LINER Zylinderlaufbuchse/ camisas de los cilindros/ втулка цилиндра	PISTON + RINGS Kolben + Ringe/ Pistón + Anillos/ поршень и кольца	PISTON SET Kolben Set/ Pistón Set/ поршневой	RINGS SET Ring Set/ Anillos Set/ кольца	PIN Pin/ Perno/ Пин
ED35 3,465 cc 4 cyl 102.5 mm Bore Ø		Liner/ Sleeve	Piston		Rings	
		Length: 191.0 Outside Ø: 113.0 Flange Ø: 119.0 Flange depth: 8.0 +1.0	Length: 98.0 Comp. height: 59.0 -4.2	Top: 3.0 2nd: 2.0 oil: 4.0	Ø: 34.0 Length: 85.0	
		Reference no.:	Reference no.:	Reference no.:	Reference no.:	Reference no.:
		11012-01T01	O-Ring: 11018-01T00 11018-01T01	12010-56T12	12033-56T10	12030-Z5000
NM-Motorservice Article no./ Artikelnummer/ Modelo número/ статья номер	NM-Motorservice Article no.:	NM-Motorservice Article no.:	NM-Motorservice Article no.:	NM-Motorservice Article no.:	NM-Motorservice Article no.:	NM-Motorservice Article no.:
	LBS 32050 FA	LB 32050 F	KBS 32050 A	KB 32050 A	KR 32050	PB 32050

ENGINE TYPE Motortyp/ tipo de motor/ тип двигателя	LINER KIT Liner Kit/ camisas de los cilindros/ Лайнер комплект	CYL. LINER Zylinderlaufbuchse/ camisas de los cilindros/ втулка цилиндра		PISTON + RINGS Kolben + Ringe/ Pistón + Anillos/ поршень и кольца		PISTON SET Kolben Set/ Pistón Set/ поршневой	RINGS SET Ring Set/ Anillos Set/ кольца		PIN Pin/ Perno/ Пин	
FD35T			Liner/ Sleeve	Piston			Rings		Ø: Length:	34.0 85.0
		Length: Outside Ø: Flange Ø: Flange depth:	191.0 113.0 119.0 8.0 +1.0	Length: Comp. height:	98.2 59.2 -11.0 -16.2		Top: 2nd: oil:	3.0 2.0 4.0		
3,465 cc 4 cyl 102.5 mm Bore Ø		Reference no.:		Reference no.:	Reference no.:	Reference no.:	Reference no.:	Reference no.:		
		11012-01T01		O-Ring: 11018-01T00 11018-01T01	12010-01T03	12033-01T60	12030-Z5000			
NM-Motorservice Article no./ Artikelnummer/ Modelo número/ статья номер	NM-Motorservice Article no.:	NM-Motorservice Article no.:		NM-Motorservice Article no.:	NM-Motorservice Article no.:	NM-Motorservice Article no.:	NM-Motorservice Article no.:		NM-Motorservice Article no.:	
	LBS 32100 FA	LB 32100 F		KBS 32100 A	KB 32100 A	KR 32100	PB 32100			

ENGINE TYPE Motortyp/ tipo de motor/ тип двигателя	LINER KIT Liner Kit/ camisas de los cilindros/ Лайнер комплект	CYL. LINER Zylinderlaufbuchse/ camisas de los cilindros/ втулка цилиндра		PISTON + RINGS Kolben + Ringe/ Pistón + Anillos/ поршень и кольца		PISTON SET Kolben Set/ Pistón Set/ поршневой	RINGS SET Ring Set/ Anillos Set/ кольца		PIN Pin/ Perno/ Пин	
FD35			Liner/ Sleeve	Piston			Rings		Ø: Length:	34.0 85.0
		Length: Outside Ø: Flange Ø: Flange depth:	191.0 113.0 119.0 8.0 +1.0	Length: Comp. height:	98.2 59.2 -11.1 -16.8		Top: 2nd: oil:	2.0 2.0 4.0		
3,465 cc 4 cyl 102.5 mm Bore Ø		Reference no.:		Reference no.:	Reference no.:	Reference no.:	Reference no.:	Reference no.:		
		11012-01T01		O-Ring: 11018-01T00 11018-01T01	12010-01T04	12033-01T10	12030-Z5000			
NM-Motorservice Article no./ Artikelnummer/ Modelo número/ статья номер	NM-Motorservice Article no.:	NM-Motorservice Article no.:		NM-Motorservice Article no.:	NM-Motorservice Article no.:	NM-Motorservice Article no.:	NM-Motorservice Article no.:		NM-Motorservice Article no.:	
	LBS 32150 FA	LB 32150 F		KBS 32150 A	KB 32150 A	KR 32150	PB 32150			

ENGINE TYPE Motortyp/ tipo de motor/ тип двигателя	LINER KIT Liner Kit/ camisas de los cilindros/ Лайнер комплект	CYL. LINER Zylinderlaufbuchse/ camisas de los cilindros/ втулка цилиндра		PISTON + RINGS Kolben + Ringe/ Pistón + Anillos/ поршень и кольца		PISTON SET Kolben Set/ Pistón Set/ поршневой	RINGS SET Ring Set/ Anillos Set/ кольца		PIN Pin/ Perno/ Пин	
FD46			Liner/ Sleeve	Piston			Rings		Ø: Length:	36.0 93.0
		Length: Outside Ø: Flange Ø: Flange depth:	213.5 111.0 115.9 8.0 +1.0	Length: Comp. height:	87.1 59.2 -10.4 -22.2		Top: 2nd: oil:	3.0 2.0 4.0		
4,617 cc 4 cyl 108.0 mm Bore Ø		Reference no.:		Reference no.:	Reference no.:	Reference no.:	Reference no.:	Reference no.:		
		11012-0T300			12010-0T302 12010-0T312	12033-0T000 12033-0T010 12033-0T011 12033-0T060	12030-0T000 12030-0T001			
NM-Motorservice Article no./ Artikelnummer/ Modelo número/ статья номер	NM-Motorservice Article no.:	NM-Motorservice Article no.:		NM-Motorservice Article no.:	NM-Motorservice Article no.:	NM-Motorservice Article no.:	NM-Motorservice Article no.:		NM-Motorservice Article no.:	
	LBS 32200 FA LBS 32200 SA	LB 32200 F LB 32200 S		KBS 32200 A	KB 32200 A	KR 32200	PB 32200			

ENGINE TYPE Motortyp/ tipo de motor/ тип двигателя	LINER KIT Liner Kit/ camisas de los cilindros/ Лайнер комплект	CYL. LINER Zylinderlaufbuchse/ camisas de los cilindros/ втулка цилиндра	PISTON + RINGS Kolben + Ringe/ Pistón + Anillos/ поршень и кольца	PISTON SET Kolben Set/ Pistón Set/ поршневой	RINGS SET Ring Set/ Anillos Set/ кольца	PIN Pin/ Perno/ Пин																																	
FD42 4,214 cc 4 cyl 108.0 mm Bore Ø		<table border="1"> <tr> <td></td> <td>Liner/ Sleeve</td> <td></td> </tr> <tr> <td>Length:</td> <td>197.0</td> <td></td> </tr> <tr> <td>Outside Ø:</td> <td>111.0</td> <td></td> </tr> <tr> <td>Flange Ø:</td> <td>115.9</td> <td></td> </tr> <tr> <td>Flange depth:</td> <td>8.0 +0.9</td> <td></td> </tr> </table>		Liner/ Sleeve		Length:	197.0		Outside Ø:	111.0		Flange Ø:	115.9		Flange depth:	8.0 +0.9		<table border="1"> <tr> <td colspan="2">Piston</td> </tr> <tr> <td>Length:</td> <td>87.1</td> </tr> <tr> <td>Comp. height:</td> <td>59.2 -8.0 -21.6</td> </tr> </table>	Piston		Length:	87.1	Comp. height:	59.2 -8.0 -21.6	Alfin and with oil gallery	<table border="1"> <tr> <td colspan="2">Rings</td> </tr> <tr> <td>Top:</td> <td>3.0</td> </tr> <tr> <td>2nd:</td> <td>2.0</td> </tr> <tr> <td>oil:</td> <td>4.0</td> </tr> </table>	Rings		Top:	3.0	2nd:	2.0	oil:	4.0	<table border="1"> <tr> <td>Ø:</td> <td>36.0</td> </tr> <tr> <td>Length:</td> <td>93.0</td> </tr> </table>	Ø:	36.0	Length:	93.0
				Liner/ Sleeve																																			
Length:	197.0																																						
Outside Ø:	111.0																																						
Flange Ø:	115.9																																						
Flange depth:	8.0 +0.9																																						
Piston																																							
Length:	87.1																																						
Comp. height:	59.2 -8.0 -21.6																																						
Rings																																							
Top:	3.0																																						
2nd:	2.0																																						
oil:	4.0																																						
Ø:	36.0																																						
Length:	93.0																																						
	Reference no.:	Reference no.:	Reference no.:	Reference no.:	Reference no.:																																		
	11012-0T000 11012-0T001		12010-0T016	12033-0T000 12033-0T010 12033-0T011 12033-0T060	12030-0T000 12030-0T001																																		
NM-Motorservice Article no./ Artikelnummer/ Modelo número/ статья номер	NM-Motorservice Article no.:	NM-Motorservice Article no.:	NM-Motorservice Article no.:	NM-Motorservice Article no.:	NM-Motorservice Article no.:	NM-Motorservice Article no.:																																	
	LBS 32250 FB LBS 32250 SB	LB 32250 F LB 32250 S	KBS 32250 B	KB 32250 B	KR 32250	PB 32250																																	

ENGINE TYPE Motortyp/ tipo de motor/ тип двигателя	LINER KIT Liner Kit/ camisas de los cilindros/ Лайнер комплект	CYL. LINER Zylinderlaufbuchse/ camisas de los cilindros/ втулка цилиндра	PISTON + RINGS Kolben + Ringe/ Pistón + Anillos/ поршень и кольца	PISTON SET Kolben Set/ Pistón Set/ поршневой	RINGS SET Ring Set/ Anillos Set/ кольца	PIN Pin/ Perno/ Пин																																	
FD46 FD46T 4,617 cc 4 cyl 108.0 mm Bore Ø		<table border="1"> <tr> <td></td> <td>Liner/ Sleeve</td> <td></td> </tr> <tr> <td>Length:</td> <td>213.5</td> <td></td> </tr> <tr> <td>Outside Ø:</td> <td>111.0</td> <td></td> </tr> <tr> <td>Flange Ø:</td> <td>115.9</td> <td></td> </tr> <tr> <td>Flange depth:</td> <td>8.0 +1.0</td> <td></td> </tr> </table>		Liner/ Sleeve		Length:	213.5		Outside Ø:	111.0		Flange Ø:	115.9		Flange depth:	8.0 +1.0		<table border="1"> <tr> <td colspan="2">Piston</td> </tr> <tr> <td>Length:</td> <td>87.1</td> </tr> <tr> <td>Comp. height:</td> <td>59.2 -10.4 -22.2</td> </tr> </table>	Piston		Length:	87.1	Comp. height:	59.2 -10.4 -22.2	Alfin and with oil gallery	<table border="1"> <tr> <td colspan="2">Rings</td> </tr> <tr> <td>Top:</td> <td>3.0</td> </tr> <tr> <td>2nd:</td> <td>2.0</td> </tr> <tr> <td>oil:</td> <td>4.0</td> </tr> </table>	Rings		Top:	3.0	2nd:	2.0	oil:	4.0	<table border="1"> <tr> <td>Ø:</td> <td>36.0</td> </tr> <tr> <td>Length:</td> <td>93.0</td> </tr> </table>	Ø:	36.0	Length:	93.0
				Liner/ Sleeve																																			
Length:	213.5																																						
Outside Ø:	111.0																																						
Flange Ø:	115.9																																						
Flange depth:	8.0 +1.0																																						
Piston																																							
Length:	87.1																																						
Comp. height:	59.2 -10.4 -22.2																																						
Rings																																							
Top:	3.0																																						
2nd:	2.0																																						
oil:	4.0																																						
Ø:	36.0																																						
Length:	93.0																																						
	Reference no.:	Reference no.:	Reference no.:	Reference no.:	Reference no.:																																		
	11012-0T300		12010-0T311	12033-0T000 12033-0T010 12033-0T011 12033-0T060	12030-0T000 12030-0T001																																		
NM-Motorservice Article no./ Artikelnummer/ Modelo número/ статья номер	NM-Motorservice Article no.:	NM-Motorservice Article no.:	NM-Motorservice Article no.:	NM-Motorservice Article no.:	NM-Motorservice Article no.:	NM-Motorservice Article no.:																																	
	LBS 32300 FB LBS 32300 SB	LB 32300 F LB 32300 S	KBS 32300 B	KB 32300 B	KR 32300	PB 32300																																	

ENGINE TYPE Motortyp/ tipo de motor/ тип двигателя	LINER KIT Liner Kit/ camisas de los cilindros/ Лайнер комплект	CYL. LINER Zylinderlaufbuchse/ camisas de los cilindros/ втулка цилиндра	PISTON + RINGS Kolben + Ringe/ Pistón + Anillos/ поршень и кольца	PISTON SET Kolben Set/ Pistón Set/ поршневой	RINGS SET Ring Set/ Anillos Set/ кольца	PIN Pin/ Perno/ Пин																																					
SD33(T) 5 Rings FORKLIFT RATROL (R) (160 SERIES F05) 1983-1988 3,246 cc 6 cyl 83.0 mm Bore Ø		<table border="1"> <tr> <td></td> <td>Liner/ Sleeve</td> <td></td> </tr> <tr> <td>Length:</td> <td>176.0</td> <td></td> </tr> <tr> <td>Outside Ø:</td> <td>87.0</td> <td></td> </tr> <tr> <td>Flange Ø:</td> <td>93.0</td> <td></td> </tr> <tr> <td>Flange depth:</td> <td>5.0</td> <td></td> </tr> </table>		Liner/ Sleeve		Length:	176.0		Outside Ø:	87.0		Flange Ø:	93.0		Flange depth:	5.0		<table border="1"> <tr> <td colspan="2">Piston</td> </tr> <tr> <td>Length:</td> <td>96.0</td> </tr> <tr> <td>Comp. height:</td> <td>48.0 -0.7 -2.1</td> </tr> </table>	Piston		Length:	96.0	Comp. height:	48.0 -0.7 -2.1		<table border="1"> <tr> <td colspan="2">Rings</td> </tr> <tr> <td>Top:</td> <td>2.5</td> </tr> <tr> <td>2nd:</td> <td>2.0</td> </tr> <tr> <td>3rd:</td> <td>2.0</td> </tr> <tr> <td>1st oil:</td> <td>4.5</td> </tr> <tr> <td>2nd oil:</td> <td>4.5</td> </tr> </table>	Rings		Top:	2.5	2nd:	2.0	3rd:	2.0	1st oil:	4.5	2nd oil:	4.5	<table border="1"> <tr> <td>Ø:</td> <td>26.0</td> </tr> <tr> <td>Length:</td> <td>71.0</td> </tr> </table>	Ø:	26.0	Length:	71.0
				Liner/ Sleeve																																							
Length:	176.0																																										
Outside Ø:	87.0																																										
Flange Ø:	93.0																																										
Flange depth:	5.0																																										
Piston																																											
Length:	96.0																																										
Comp. height:	48.0 -0.7 -2.1																																										
Rings																																											
Top:	2.5																																										
2nd:	2.0																																										
3rd:	2.0																																										
1st oil:	4.5																																										
2nd oil:	4.5																																										
Ø:	26.0																																										
Length:	71.0																																										
	Reference no.:	Reference no.:	Reference no.:	Reference no.:	Reference no.:																																						
	11012-76200 11012-76201 11012-C8701		12010-J5310 12010-J5311 12010-J5312 12010-Y1411 12010-Y5210 12010-Y5211	12033-61500 12033-61502 12033-61503 12033-C6810 12033-C6812 12033-J2200 12033-J2201 12033-J2202 12033-J2204	12030-37500																																						
NM-Motorservice Article no./ Artikelnummer/ Modelo número/ статья номер	NM-Motorservice Article no.:	NM-Motorservice Article no.:	NM-Motorservice Article no.:	NM-Motorservice Article no.:	NM-Motorservice Article no.:	NM-Motorservice Article no.:																																					
	LBS 32350 F LBS 32350 S	LB 32350 F LB 32350 S	KBS 32350	KB 32350	KR 32350	PB 32350																																					

ENGINE TYPE Motortyp/ tipo de motor/ тип двигателя	LINER KIT Liner Kit/ camisas de los cilindros/ Лайнер комплект	CYL. LINER Zylinderlaufbuchse/ camisas de los cilindros/ втулка цилиндра		PISTON + RINGS Kolben + Ringe/ Pistón + Anillos/ поршень и кольца		PISTON SET Kolben Set/ Pistón Set/ поршневой	RINGS SET Ring Set/ Anillos Set/ кольца		PIN Pin/ Perno/ Пин	
SD33(T) 3 Rings RATROL (R) (160 SERIES) 1979-1983 3,246 cc 6 cyl 83.0 mm Bore Ø			Liner/ Sleeve	Piston			Rings		Ø : 26.0 Length: 68.0	
		Length: Outside Ø: Flange Ø: Flange depth:	176.0 87.0 93.0 5.0	Length: Comp. height:	80.2 48.2 -0.7 -2.1		Top: 2nd: oil:	2.5 2.0 4.0		
		Reference no.:	Reference no.:	Reference no.:	Reference no.:		Reference no.:			
		11012-76200 11012-76201 11012-C8701			12010-C8602 12010-C8612 12010-C8701 12010-C8711	12033-C8702 12033-C8704		12030-37500		
NM-Motorservice Article no./ Artikelnummer/ Modelo número/ статья номер	NM-Motorservice Article no.:	NM-Motorservice Article no.:	NM-Motorservice Article no.:	NM-Motorservice Article no.:	NM-Motorservice Article no.:	NM-Motorservice Article no.:	NM-Motorservice Article no.:	NM-Motorservice Article no.:	NM-Motorservice Article no.:	
	LBS 32400 FA LBS 32400 SA	LB 32400 F LB 32400 S		KBS 32400 A	KB 32400 A	KB 32400 A	KR 32400	PB 32400		



ENGINE TYPE Motortyp/ tipo de motor/ тип двигателя	LINER KIT Liner Kit/ camisas de los cilindros/ Лайнер комплект	CYL. LINER Zylinderlaufbuchse/ camisas de los cilindros/ втулка цилиндра		PISTON + RINGS Kolben + Ringe/ Pistón + Anillos/ поршень и кольца		PISTON SET Kolben Set/ Pistón Set/ поршневой	RINGS SET Ring Set/ Anillos Set/ кольца		PIN Pin/ Perno/ Пин	
SD33T 5 Rings 3,246 cc 6 cyl 83.0 mm Bore Ø			Liner/ Sleeve	Piston			Rings		Ø : 26.0 Length: 71.0	
		Length: Outside Ø: Flange Ø: Flange depth:	176.0 87.0 93.0 5.0	Length: Comp. height:	96.0 48.0 -2.0		Top: 2nd: 3rd: 1st oil: 2nd oil:	2.5 2.0 2.0 4.5 4.5		
		Reference no.:	Reference no.:	Reference no.:	Reference no.:		Reference no.:			
		11012-76200 11012-76201 11012-C8701				12033-90000		12030-37500		
NM-Motorservice Article no./ Artikelnummer/ Modelo número/ статья номер	NM-Motorservice Article no.:	NM-Motorservice Article no.:	NM-Motorservice Article no.:	NM-Motorservice Article no.:	NM-Motorservice Article no.:	NM-Motorservice Article no.:	NM-Motorservice Article no.:	NM-Motorservice Article no.:	NM-Motorservice Article no.:	
	LBS 32450 FA LBS 32450 SA	LB 32450 F LB 32450 S		KBS 32450 A	KB 32450 A	KB 32450 A	KR 32450	PB 32450		



ENGINE TYPE Motortyp/ tipo de motor/ тип двигателя	LINER KIT Liner Kit/ camisas de los cilindros/ Лайнер комплект	CYL. LINER Zylinderlaufbuchse/ camisas de los cilindros/ втулка цилиндра		PISTON + RINGS Kolben + Ringe/ Pistón + Anillos/ поршень и кольца		PISTON SET Kolben Set/ Pistón Set/ поршневой	RINGS SET Ring Set/ Anillos Set/ кольца		PIN Pin/ Perno/ Пин	
V9X NAVARA(D40M) • PATHFINDER(R51M) 2,993 cc 6 cyl 84.0 mm Bore Ø			Flanged	No flange	Piston		Alfin and with oil gallery		Rings	
		Length: Outside Ø: Flange Ø: Flange depth:			Length: Comp. height:		Top: 2nd: oil:		Ø : Length:	
		Reference no.:	Reference no.:	Reference no.:	Reference no.:	Reference no.:				
					O-Ring:					
NM-Motorservice Article no./ Artikelnummer/ Modelo número/ статья номер	NM-Motorservice Article no.:	NM-Motorservice Article no.:	NM-Motorservice Article no.:	NM-Motorservice Article no.:	NM-Motorservice Article no.:	NM-Motorservice Article no.:	NM-Motorservice Article no.:	NM-Motorservice Article no.:	NM-Motorservice Article no.:	
				KBS 45400 B	KB 45400 B	KB 45400 B	KR 45400			

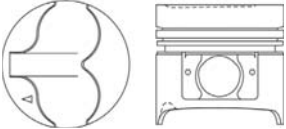

ENGINE TYPE Motor/тип de motor/ тип двигателя	LINER KIT Liner Kit/ camisas de los cilindros/ Лайнер комплект	CYL. LINER Zylinderlaufbuchse/ camisas de los cilindros/ втулка цилиндра			PISTON + RINGS Kolben + Ringe/ Pistón + Anillos/ поршень и кольца		PISTON SET Kolben Set/ Pistón Set/ поршневой	RINGS SET Ring Set/ Anillos Set/ кольца		PIN Pin/ Perno/ Пин
LD28 LAUREL (C32) 1985-1987 2,792 cc 6 cyl 84.5 mm Bore Ø			Flanged	No flange	Piston		Rings Top: 2.0 2nd: 2.0 oil: 4.0 Reference no.:	Ø : 25.0 Length: 67.0		
		Length:	150.0	150.0	Length:	86.4		Reference no.: 12010-V0702 12010-V0762 12010-V5702 12010-V5756 12010-V5762 12010-V5764 12010-V5766 12010-W2502	Reference no.: 12033-60L00 12033-V0700 12036-60L00 12036-V0700 12038-60L00 12038-V0700	
		Outside Ø:	88.5	88.5	Comp. height:	46.5			Reference no.: 12030-V0700 12030-V0701	
Flange Ø:	90.0			-2.0						
		Reference no.: 11012-V0700			Reference no.:					
NM-Motorservice Article no./ Artikelnummer/ Modelo número/ статья номер	NM-Motorservice Article no.:	NM-Motorservice Article no.:			NM-Motorservice Article no.:		NM-Motorservice Article no.:	NM-Motorservice Article no.:		NM-Motorservice Article no.:
	LBS 32550 P LBS 32550 S	LB 32550 P LB 32550 S			KBS 32550		KB 32550	KR 32550		PB 32550

ENGINE TYPE Motor/тип de motor/ тип двигателя	LINER KIT Liner Kit/ camisas de los cilindros/ Лайнер комплект	CYL. LINER Zylinderlaufbuchse/ camisas de los cilindros/ втулка цилиндра			PISTON + RINGS Kolben + Ringe/ Pistón + Anillos/ поршень и кольца		PISTON SET Kolben Set/ Pistón Set/ поршневой	RINGS SET Ring Set/ Anillos Set/ кольца		PIN Pin/ Perno/ Пин
RD28 2,825 cc 6 cyl 85.0 mm Bore Ø			Flanged	No flange	Piston		Rings Top: 2.0 2nd: 2.0 oil: 4.0 Reference no.: 12033-20V01 12033-22J00/11/21 12033-35E00 12033-40L01/11 12036-20V02 12036-22J00/11/21 12036-35E00 12036-40L01/11 12038-20V04 12038-22J00/11/21 12038-35E00 12038-40L01/11	Ø : 25.0 Length: 66.5		
		Length:	150.0	150.0	Length:	78.0		Reference no.: 12010-V7213 A2010-V7213	Reference no.: 12030-V7200	
		Outside Ø:	89.0	89.0	Comp. height:	46.5				
Flange Ø:	93.0			-1.2						
		Reference no.: 11012-V2070			Reference no.:					
NM-Motorservice Article no./ Artikelnummer/ Modelo número/ статья номер	NM-Motorservice Article no.:	NM-Motorservice Article no.:			NM-Motorservice Article no.:		NM-Motorservice Article no.:	NM-Motorservice Article no.:		NM-Motorservice Article no.:
	LBS 32600 P LBS 32600 S	LB 32600 P LB 32600 S			KBS 32600		KB 32600	KR 32600		PB 32600

ENGINE TYPE Motor/тип de motor/ тип двигателя	LINER KIT Liner Kit/ camisas de los cilindros/ Лайнер комплект	CYL. LINER Zylinderlaufbuchse/ camisas de los cilindros/ втулка цилиндра			PISTON + RINGS Kolben + Ringe/ Pistón + Anillos/ поршень и кольца		PISTON SET Kolben Set/ Pistón Set/ поршневой	RINGS SET Ring Set/ Anillos Set/ кольца		PIN Pin/ Perno/ Пин
RD28T RATROL (GR) (Y60) 1988-1995 2,825 cc 6 cyl 85.0 mm Bore Ø			Flanged	No flange	Piston		Alfin and with oil gallery Rings Top: 2.0 2nd: 2.0 oil: 4.0 Reference no.: 12033-20V01 12033-22J00/11/21 12033-35E00 12033-40L01/11 12036-20V02 12036-22J00/11/21 12036-35E00 12036-40L01/11 12038-20V04 12038-22J00/11/21 12038-35E00 12038-40L01/11	Ø : 27.0 Length: 66.8		
		Length:	150.0	150.0	Length:	78.3		Reference no.: 12010-22J11 12010-22J12/3 12010-22J14/5 12010-22J62 12010-22J64/6	Reference no.: 12030-22J01	
		Outside Ø:	89.0	89.0	Comp. height:	46.8				
Flange Ø:	93.0			-1.3						
		Reference no.: 11012-V2070			Reference no.:					
NM-Motorservice Article no./ Artikelnummer/ Modelo número/ статья номер	NM-Motorservice Article no.:	NM-Motorservice Article no.:			NM-Motorservice Article no.:		NM-Motorservice Article no.:	NM-Motorservice Article no.:		NM-Motorservice Article no.:
	LBS 32650 PB LBS 32650 SB	LB 32650 P LB 32650 S			KBS 32650 B		KB 32650 B	KR 32650		PB 32650

ENGINE TYPE Motortyp/ tipo de motor/ тип двигателя	LINER KIT Liner Kit/ camisas de los cilindros/ Лайнер комплект	CYL. LINER Zylinderlaufbuchse/ camisas de los cilindros/ втулка цилиндра		PISTON + RINGS Kolben + Ringe/ Pistón + Anillos/ поршень и кольца	PISTON SET Kolben Set/ Pistón Set/ поршневой	RINGS SET Ring Set/ Anillos Set/ кольца	PIN Pin/ Perno/ Пин						
RD28Ti New RATROL (GR) (Y61) 1997-2000 2,825 cc 6 cyl 85.0 mm Bore Ø			No flange	Piston		Rings							
		Length: Outside Ø: Flange Ø: Flange depth:	150.0 89.0 93.0 2.0	150.0 89.0	Length: Comp. height:	78.3 46.8 -0.7 -1.8	Alfin and with oil gallery head anodized	Top: 2nd: oil:	2.0 2.0 4.0	Ø: Length:	27.0 61.5		
		Reference no.:		Reference no.:		Reference no.:		Reference no.:		Reference no.:			
		11012-V2070				A2010-VB300 A2010-VB301 A2010-VB302 A2010-VB372 A2010-VB373		12033-81T10 12036-81T10 12038-81T10		12030-22J01			
NM-Motorservice Article no./ Artikelnummer/ Modelo número/ статья номер		NM-Motorservice Article no.:		NM-Motorservice Article no.:		NM-Motorservice Article no.:		NM-Motorservice Article no.:		NM-Motorservice Article no.:			
		LBS 49500 PB LBS 49500 SB		LB 49500 P LB 49500 S		KBS 49500 B		KB 49500 B		KR 49500		PB 49500	

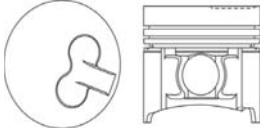





ENGINE TYPE Motortyp/ tipo de motor/ тип двигателя	LINER KIT Liner Kit/ camisas de los cilindros/ Лайнер комплект	CYL. LINER Zylinderlaufbuchse/ camisas de los cilindros/ втулка цилиндра		PISTON + RINGS Kolben + Ringe/ Pistón + Anillos/ поршень и кольца	PISTON SET Kolben Set/ Pistón Set/ поршневой	RINGS SET Ring Set/ Anillos Set/ кольца	PIN Pin/ Perno/ Пин						
TD42 FORKLIFT (F03 F05) 1989-1996 4,169 cc 6 cyl 96.0 mm Bore Ø			Liner/ Sleeve	Piston		Rings							
		Length: Outside Ø: Flange Ø: Flange depth:	164.0 99.0 105.0 5.0		Length: Comp. height:	87.0 50.2 -0.8 -1.7	Top: 2nd: oil:	2.5 2.0 4.0	Ø: Length:	28.0 80.0			
		Reference no.:		Reference no.:		Reference no.:		Reference no.:		Reference no.:			
		11012-06J00				12010-10T02 12010-10T12 12010-43G02 12010-43G12		12033-06J01 12033-06J10 12033-06J11		12030-43G00			
NM-Motorservice Article no./ Artikelnummer/ Modelo número/ статья номер		NM-Motorservice Article no.:		NM-Motorservice Article no.:		NM-Motorservice Article no.:		NM-Motorservice Article no.:		NM-Motorservice Article no.:			
		LBS 32750 F LBS 32750 S LBS 32750 FA LBS 32750 SA		LB 32750 F LB 32750 S		KBS 32750 KBS 32750 A		KB 32750 KB 32750 A		KR 32750		PB 32750	

ENGINE TYPE Motortyp/ tipo de motor/ тип двигателя	LINER KIT Liner Kit/ camisas de los cilindros/ Лайнер комплект	CYL. LINER Zylinderlaufbuchse/ camisas de los cilindros/ втулка цилиндра		PISTON + RINGS Kolben + Ringe/ Pistón + Anillos/ поршень и кольца	PISTON SET Kolben Set/ Pistón Set/ поршневой	RINGS SET Ring Set/ Anillos Set/ кольца	PIN Pin/ Perno/ Пин						
TD42 New 4,169 cc 6 cyl 96.0 mm Bore Ø			Liner/ Sleeve	Piston		Rings							
		Length: Outside Ø: Flange Ø: Flange depth:	164.0 99.0 105.0 5.0		Length: Comp. height:	86.0 50.3 -0.5 -1.7	Top: 2nd: oil:	2.5 2.0 3.0	Ø: Length:	30.0 74.0			
		Reference no.:		Reference no.:		Reference no.:		Reference no.:		Reference no.:			
		11012-06J00				12010-6T000 12010-6T010		12033-06J15		12030-31N00			
NM-Motorservice Article no./ Artikelnummer/ Modelo número/ статья номер		NM-Motorservice Article no.:		NM-Motorservice Article no.:		NM-Motorservice Article no.:		NM-Motorservice Article no.:		NM-Motorservice Article no.:			
		LBS 32800 FA LBS 32800 SA		LB 32800 F LB 32800 S		KBS 32800 A		KB 32800 A		KR 32800		PB 32800	

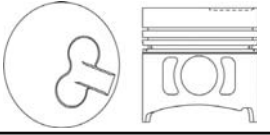
ENGINE TYPE Motortyp/ tipo de motor/ тип двигателя	LINER KIT Liner Kit/ camisas de los cilindros/ Лайнер комплект	CYL. LINER Zylinderlaufbuchse/ camisas de los cilindros/ втулка цилиндра	PISTON + RINGS Kolben + Ringe/ Pistón + Anillos/ поршень и кольца	PISTON SET Kolben Set/ Pistón Set/ поршневой	RINGS SET Ring Set/ Anillos Set/ кольца	PIN Pin/ Perno/ Пин	
TD42T 4,169 cc 6 cyl 96.0 mm Bore Ø		Liner/ Sleeve	Piston		Alfin and with oil gallery	Rings	Ø : 30.0 Length: 80.0
		Length: Outside Ø: Flange Ø: Flange depth:	164.0 99.0 105.0 5.0	Length: Comp. height:			
		Reference no.:	Reference no.:	Reference no.:	Reference no.:	Reference no.:	
		11012-06J00		12010-05D00 12010-05D10 12010-31N03	12033-05D01	12030-31N00	
NM-Motorservice Article no./ Artikelnummer/ Modelo número/ статья номер	NM-Motorservice Article no.:	NM-Motorservice Article no.:	NM-Motorservice Article no.:	NM-Motorservice Article no.:	NM-Motorservice Article no.:	NM-Motorservice Article no.:	
	LBS 32850 FB LBS 32850 SB	LB 32850 F LB 32850 S	KBS 32850 B	KB 32850 B	KR 32850	PB 32850	

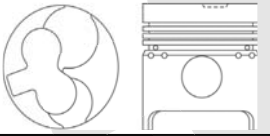
ENGINE TYPE Motortyp/ tipo de motor/ тип двигателя	LINER KIT Liner Kit/ camisas de los cilindros/ Лайнер комплект	CYL. LINER Zylinderlaufbuchse/ camisas de los cilindros/ втулка цилиндра	PISTON + RINGS Kolben + Ringe/ Pistón + Anillos/ поршень и кольца	PISTON SET Kolben Set/ Pistón Set/ поршневой	RINGS SET Ring Set/ Anillos Set/ кольца	PIN Pin/ Perno/ Пин
TD42T 4,169 cc 6 cyl 96.0 mm Bore Ø		Liner/ Sleeve	Piston		Rings	Ø : 30.0 Length: 74.0
		Length: Outside Ø: Flange Ø: Flange depth:	164.0 99.0 105.0 5.0	Length: Comp. height:		
		Reference no.:	Reference no.:	Reference no.:	Reference no.:	Reference no.:
		11012-06J00		12010-10T05	12033-06J15	12030-31N00
NM-Motorservice Article no./ Artikelnummer/ Modelo número/ статья номер	NM-Motorservice Article no.:	NM-Motorservice Article no.:	NM-Motorservice Article no.:	NM-Motorservice Article no.:	NM-Motorservice Article no.:	NM-Motorservice Article no.:
	LBS 32900 FA LBS 32900 SA	LB 32900 F LB 32900 S	KBS 32900 A	KB 32900 A	KR 32900	PB 32900

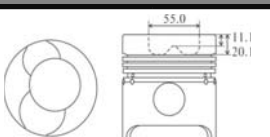
ENGINE TYPE Motortyp/ tipo de motor/ тип двигателя	LINER KIT Liner Kit/ camisas de los cilindros/ Лайнер комплект	CYL. LINER Zylinderlaufbuchse/ camisas de los cilindros/ втулка цилиндра	PISTON + RINGS Kolben + Ringe/ Pistón + Anillos/ поршень и кольца	PISTON SET Kolben Set/ Pistón Set/ поршневой	RINGS SET Ring Set/ Anillos Set/ кольца	PIN Pin/ Perno/ Пин
TD42T II TD42T New 4,169 cc 6 cyl 96.0 mm Bore Ø		Liner/ Sleeve	Piston		Alfin and with oil gallery head anodized skirt MOS2 treated	Ø : 30.0 Length: 79.8
		Length: Outside Ø: Flange Ø: Flange depth:	164.0 99.0 105.0 5.0	Length: Comp. height:		
		Reference no.:	Reference no.:	Reference no.:	Reference no.:	Reference no.:
		11012-06J00		A2010-9C626	12033-0W813 12033-0W814 12033-DY712 12033-WJ115 12033-WJ116 12033-WJ11A	12030-31N00
NM-Motorservice Article no./ Artikelnummer/ Modelo número/ статья номер	NM-Motorservice Article no.:	NM-Motorservice Article no.:	NM-Motorservice Article no.:	NM-Motorservice Article no.:	NM-Motorservice Article no.:	NM-Motorservice Article no.:
	LBS 32950 FB LBS 32950 SB	LB 32950 F LB 32950 S	KBS 32950 B	KB 32950 B	KR 32950	PB 32950

ENGINE TYPE Motortyp/ tipo de motor/ тип двигателя	LINER KIT Liner Kit/ camisas de los cilindros/ Лайнер комплект	CYL. LINER Zylinderlaufbuchse/ camisas de los cilindros/ втулка цилиндра	PISTON + RINGS Kolben + Ringe/ Pistón + Anillos/ поршень и кольца	PISTON SET Kolben Set/ Pistón Set/ поршневой	RINGS SET Ring Set/ Anillos Set/ кольца	PIN Pin/ Perno/ Пин																																				
TD42T TD42Ti		<table border="1"> <tr> <td>Liner/ Sleeve</td> <td></td> </tr> <tr> <td>Length:</td> <td>164.0</td> </tr> <tr> <td>Outside Ø:</td> <td>99.0</td> </tr> <tr> <td>Flange Ø:</td> <td>105.0</td> </tr> <tr> <td>Flange depth:</td> <td>5.0</td> </tr> </table>	Liner/ Sleeve		Length:	164.0	Outside Ø:	99.0	Flange Ø:	105.0	Flange depth:	5.0	<table border="1"> <tr> <td colspan="2">Piston</td> </tr> <tr> <td>Length:</td> <td>87.0</td> </tr> <tr> <td>Comp. height:</td> <td>50.2</td> </tr> <tr> <td></td> <td>-0.8</td> </tr> <tr> <td></td> <td>-1.7</td> </tr> </table>	Piston		Length:	87.0	Comp. height:	50.2		-0.8		-1.7	Alfin and with oil gallery	<table border="1"> <tr> <td colspan="2">Rings</td> </tr> <tr> <td>Top:</td> <td>2.5</td> </tr> <tr> <td>2nd:</td> <td>2.0</td> </tr> <tr> <td>oil:</td> <td>3.0</td> </tr> </table>	Rings		Top:	2.5	2nd:	2.0	oil:	3.0	<table border="1"> <tr> <td>Ø:</td> <td>30.0</td> </tr> <tr> <td>Length:</td> <td>80.0</td> </tr> </table>	Ø:	30.0	Length:	80.0				
			Liner/ Sleeve																																							
Length:	164.0																																									
Outside Ø:	99.0																																									
Flange Ø:	105.0																																									
Flange depth:	5.0																																									
Piston																																										
Length:	87.0																																									
Comp. height:	50.2																																									
	-0.8																																									
	-1.7																																									
Rings																																										
Top:	2.5																																									
2nd:	2.0																																									
oil:	3.0																																									
Ø:	30.0																																									
Length:	80.0																																									
4,169 cc 6 cyl 96.0 mm Bore Ø					Reference no.:																																					
		Reference no.:	Reference no.:	Reference no.:	12033-0W813 12033-0W814 12033-DY712 12033-WJ115 12033-WJ116 12033-WJ11A	Reference no.:																																				
NM-Motorservice Article no./ Artikelnummer/ Modelo número/ статья номер	NM-Motorservice Article no.:	NM-Motorservice Article no.:	NM-Motorservice Article no.:	NM-Motorservice Article no.:	NM-Motorservice Article no.:	NM-Motorservice Article no.:																																				
	LBS 33000 FB LBS 33000 SB	LB 33000 F LB 33000 S	KBS 33000 B	KB 33000 B	KR 33000	PB 33000																																				
ED6		<table border="1"> <tr> <td>Liner/ Sleeve</td> <td></td> </tr> <tr> <td>Length:</td> <td>212.0</td> </tr> <tr> <td>Outside Ø:</td> <td>112.0</td> </tr> <tr> <td>Flange Ø:</td> <td>118.0</td> </tr> <tr> <td>Flange depth:</td> <td>8.05</td> </tr> <tr> <td></td> <td>+1.0</td> </tr> </table>	Liner/ Sleeve		Length:	212.0	Outside Ø:	112.0	Flange Ø:	118.0	Flange depth:	8.05		+1.0	<table border="1"> <tr> <td colspan="2">Piston</td> </tr> <tr> <td>Length:</td> <td>103.0</td> </tr> <tr> <td>Comp. height:</td> <td>59.0</td> </tr> <tr> <td></td> <td>-0.5</td> </tr> <tr> <td></td> <td>-2.2</td> </tr> </table>	Piston		Length:	103.0	Comp. height:	59.0		-0.5		-2.2		<table border="1"> <tr> <td colspan="2">Rings</td> </tr> <tr> <td>Top:</td> <td>3.0</td> </tr> <tr> <td>2nd:</td> <td>2.0</td> </tr> <tr> <td>3rd:</td> <td>2.0</td> </tr> <tr> <td>oil:</td> <td>4.5</td> </tr> </table>	Rings		Top:	3.0	2nd:	2.0	3rd:	2.0	oil:	4.5	<table border="1"> <tr> <td>Ø:</td> <td>34.0</td> </tr> <tr> <td>Length:</td> <td>85.0</td> </tr> </table>	Ø:	34.0	Length:	85.0
			Liner/ Sleeve																																							
Length:	212.0																																									
Outside Ø:	112.0																																									
Flange Ø:	118.0																																									
Flange depth:	8.05																																									
	+1.0																																									
Piston																																										
Length:	103.0																																									
Comp. height:	59.0																																									
	-0.5																																									
	-2.2																																									
Rings																																										
Top:	3.0																																									
2nd:	2.0																																									
3rd:	2.0																																									
oil:	4.5																																									
Ø:	34.0																																									
Length:	85.0																																									
5,654 cc 6 cyl 100.0 mm Bore Ø					Reference no.:	Reference no.:																																				
		Reference no.:	Reference no.:	Reference no.:	Reference no.:	Reference no.:																																				
NM-Motorservice Article no./ Artikelnummer/ Modelo número/ статья номер	NM-Motorservice Article no.:	NM-Motorservice Article no.:	NM-Motorservice Article no.:	NM-Motorservice Article no.:	NM-Motorservice Article no.:	NM-Motorservice Article no.:																																				
	LBS 33050 F	LB 33050 F (water jacket chromed)	KBS 33050	KB 33050	KR 33050	PB 33050																																				
FD6T 4 Rings		<table border="1"> <tr> <td>Liner/ Sleeve</td> <td></td> </tr> <tr> <td>Length:</td> <td>212.0</td> </tr> <tr> <td>Outside Ø:</td> <td>112.0</td> </tr> <tr> <td>Flange Ø:</td> <td>118.0</td> </tr> <tr> <td>Flange depth:</td> <td>8.05</td> </tr> <tr> <td></td> <td>+1.0</td> </tr> </table>	Liner/ Sleeve		Length:	212.0	Outside Ø:	112.0	Flange Ø:	118.0	Flange depth:	8.05		+1.0	<table border="1"> <tr> <td colspan="2">Piston</td> </tr> <tr> <td>Length:</td> <td>109.5</td> </tr> <tr> <td>Comp. height:</td> <td>65.5</td> </tr> <tr> <td></td> <td>-11.1</td> </tr> <tr> <td></td> <td>-20.1</td> </tr> </table>	Piston		Length:	109.5	Comp. height:	65.5		-11.1		-20.1		<table border="1"> <tr> <td colspan="2">Rings</td> </tr> <tr> <td>Top:</td> <td>3.0</td> </tr> <tr> <td>2nd:</td> <td>2.0</td> </tr> <tr> <td>3rd:</td> <td>2.0</td> </tr> <tr> <td>oil:</td> <td>4.5</td> </tr> </table>	Rings		Top:	3.0	2nd:	2.0	3rd:	2.0	oil:	4.5	<table border="1"> <tr> <td>Ø:</td> <td>34.0</td> </tr> <tr> <td>Length:</td> <td>85.0</td> </tr> </table>	Ø:	34.0	Length:	85.0
			Liner/ Sleeve																																							
Length:	212.0																																									
Outside Ø:	112.0																																									
Flange Ø:	118.0																																									
Flange depth:	8.05																																									
	+1.0																																									
Piston																																										
Length:	109.5																																									
Comp. height:	65.5																																									
	-11.1																																									
	-20.1																																									
Rings																																										
Top:	3.0																																									
2nd:	2.0																																									
3rd:	2.0																																									
oil:	4.5																																									
Ø:	34.0																																									
Length:	85.0																																									
5,654 cc 6 cyl 100.0 mm Bore Ø					Reference no.:	Reference no.:																																				
		Reference no.:	Reference no.:	Reference no.:	Reference no.:	Reference no.:																																				
NM-Motorservice Article no./ Artikelnummer/ Modelo número/ статья номер	NM-Motorservice Article no.:	NM-Motorservice Article no.:	NM-Motorservice Article no.:	NM-Motorservice Article no.:	NM-Motorservice Article no.:	NM-Motorservice Article no.:																																				
	LBS 33100 FA	LB 33100 F (water jacket chromed)	KBS 33100 A	KB 33100 A	KR 33100	PB 33100																																				

ENGINE TYPE Motor/тип de motor/ тип двигателя	LINER KIT Liner Kit/ camisas de los cilindros/ Лайнер комплект	CYL. LINER Zylinderlaufbuchse/ camisas de los cilindros/ втулка цилиндра	PISTON + RINGS Kolben + Ringe/ Pistón + Anillos/ поршень и кольца	PISTON SET Kolben Set/ Pistón Set/ поршневой	RINGS SET Ring Set/ Anillos Set/ кольца	PIN Pin/ Perno/ Пин																																						
FD6T 3 Rings		<table border="1"> <tr> <td></td> <td>Liner/ Sleeve</td> <td></td> </tr> <tr> <td>Length:</td> <td>212.0</td> <td></td> </tr> <tr> <td>Outside Ø:</td> <td>112.0</td> <td></td> </tr> <tr> <td>Flange Ø:</td> <td>118.0</td> <td></td> </tr> <tr> <td>Flange depth:</td> <td>8.05 +1.0</td> <td></td> </tr> </table>		Liner/ Sleeve		Length:	212.0		Outside Ø:	112.0		Flange Ø:	118.0		Flange depth:	8.05 +1.0		<table border="1"> <tr> <td></td> <td>Piston</td> <td></td> </tr> <tr> <td>Length:</td> <td>109.5</td> <td></td> </tr> <tr> <td>Comp. height:</td> <td>65.5 -11.0 -21.7</td> <td></td> </tr> </table>		Piston		Length:	109.5		Comp. height:	65.5 -11.0 -21.7			<table border="1"> <tr> <td></td> <td>Rings</td> <td></td> </tr> <tr> <td>Top:</td> <td>3.0</td> <td rowspan="3">Ø : Length:</td> </tr> <tr> <td>2nd: oil:</td> <td>2.0 4.5</td> </tr> <tr> <td></td> <td></td> </tr> </table>		Rings		Top:	3.0	Ø : Length:	2nd: oil:	2.0 4.5			<table border="1"> <tr> <td></td> <td>34.0</td> </tr> <tr> <td>85.0</td> <td></td> </tr> </table>		34.0	85.0	
				Liner/ Sleeve																																								
Length:	212.0																																											
Outside Ø:	112.0																																											
Flange Ø:	118.0																																											
Flange depth:	8.05 +1.0																																											
	Piston																																											
Length:	109.5																																											
Comp. height:	65.5 -11.0 -21.7																																											
	Rings																																											
Top:	3.0	Ø : Length:																																										
2nd: oil:	2.0 4.5																																											
	34.0																																											
85.0																																												
6 cc 5,654 cyl 100.0 mm Bore Ø																																												
NM-Motorservice Article no./ Artikelnummer/ Modelo número/ статья номер	NM-Motorservice Article no.:	NM-Motorservice Article no.:	NM-Motorservice Article no.:	NM-Motorservice Article no.:	NM-Motorservice Article no.:	NM-Motorservice Article no.:																																						
	LBS 33150 FA	LB 33150 F (water jacket chromed)	KBS 33150 A	KB 33150 A	KR 33150	PB 33150																																						

ENGINE TYPE Motor/тип de motor/ тип двигателя	LINER KIT Liner Kit/ camisas de los cilindros/ Лайнер комплект	CYL. LINER Zylinderlaufbuchse/ camisas de los cilindros/ втулка цилиндра	PISTON + RINGS Kolben + Ringe/ Pistón + Anillos/ поршень и кольца	PISTON SET Kolben Set/ Pistón Set/ поршневой	RINGS SET Ring Set/ Anillos Set/ кольца	PIN Pin/ Perno/ Пин																																						
FD6T 3 Rings		<table border="1"> <tr> <td></td> <td>Liner/ Sleeve</td> <td></td> </tr> <tr> <td>Length:</td> <td>212.0</td> <td></td> </tr> <tr> <td>Outside Ø:</td> <td>112.0</td> <td></td> </tr> <tr> <td>Flange Ø:</td> <td>118.0</td> <td></td> </tr> <tr> <td>Flange depth:</td> <td>8.05 +1.0</td> <td></td> </tr> </table>		Liner/ Sleeve		Length:	212.0		Outside Ø:	112.0		Flange Ø:	118.0		Flange depth:	8.05 +1.0		<table border="1"> <tr> <td></td> <td>Piston</td> <td></td> </tr> <tr> <td>Length:</td> <td>109.5</td> <td></td> </tr> <tr> <td>Comp. height:</td> <td>65.5 -10.2 -18.5</td> <td></td> </tr> </table>		Piston		Length:	109.5		Comp. height:	65.5 -10.2 -18.5			<table border="1"> <tr> <td></td> <td>Rings</td> <td></td> </tr> <tr> <td>Top:</td> <td>3.0</td> <td rowspan="3">Ø : Length:</td> </tr> <tr> <td>2nd: oil:</td> <td>2.0 4.5</td> </tr> <tr> <td></td> <td></td> </tr> </table>		Rings		Top:	3.0	Ø : Length:	2nd: oil:	2.0 4.5			<table border="1"> <tr> <td></td> <td>34.0</td> </tr> <tr> <td>85.0</td> <td></td> </tr> </table>		34.0	85.0	
				Liner/ Sleeve																																								
Length:	212.0																																											
Outside Ø:	112.0																																											
Flange Ø:	118.0																																											
Flange depth:	8.05 +1.0																																											
	Piston																																											
Length:	109.5																																											
Comp. height:	65.5 -10.2 -18.5																																											
	Rings																																											
Top:	3.0	Ø : Length:																																										
2nd: oil:	2.0 4.5																																											
	34.0																																											
85.0																																												
5,654 cc 6 cyl 100.0 mm Bore Ø																																												
NM-Motorservice Article no./ Artikelnummer/ Modelo número/ статья номер	NM-Motorservice Article no.:	NM-Motorservice Article no.:	NM-Motorservice Article no.:	NM-Motorservice Article no.:	NM-Motorservice Article no.:	NM-Motorservice Article no.:																																						
	LBS 33200 FA	LB 33200 F (water jacket chromed)	KBS 33200 A	KB 33200 A	KR 33200	PB 33200																																						

ENGINE TYPE Motor/тип de motor/ тип двигателя	LINER KIT Liner Kit/ camisas de los cilindros/ Лайнер комплект	CYL. LINER Zylinderlaufbuchse/ camisas de los cilindros/ втулка цилиндра	PISTON + RINGS Kolben + Ringe/ Pistón + Anillos/ поршень и кольца	PISTON SET Kolben Set/ Pistón Set/ поршневой	RINGS SET Ring Set/ Anillos Set/ кольца	PIN Pin/ Perno/ Пин																																								
FD6 4 Rings		<table border="1"> <tr> <td></td> <td>Liner/ Sleeve</td> <td></td> </tr> <tr> <td>Length:</td> <td>212.0</td> <td></td> </tr> <tr> <td>Outside Ø:</td> <td>112.0</td> <td></td> </tr> <tr> <td>Flange Ø:</td> <td>118.0</td> <td></td> </tr> <tr> <td>Flange depth:</td> <td>8.05 +1.0</td> <td></td> </tr> </table>		Liner/ Sleeve		Length:	212.0		Outside Ø:	112.0		Flange Ø:	118.0		Flange depth:	8.05 +1.0		<table border="1"> <tr> <td></td> <td>Piston</td> <td></td> </tr> <tr> <td>Length:</td> <td>109.5</td> <td></td> </tr> <tr> <td>Comp. height:</td> <td>65.5 -11.1 -20.1</td> <td></td> </tr> </table>		Piston		Length:	109.5		Comp. height:	65.5 -11.1 -20.1			<table border="1"> <tr> <td></td> <td>Rings</td> <td></td> </tr> <tr> <td>Top:</td> <td>3.0</td> <td rowspan="4">Ø : Length:</td> </tr> <tr> <td>2nd:</td> <td>2.0</td> </tr> <tr> <td>3rd: oil:</td> <td>2.0 4.5</td> </tr> <tr> <td></td> <td></td> </tr> </table>		Rings		Top:	3.0	Ø : Length:	2nd:	2.0	3rd: oil:	2.0 4.5			<table border="1"> <tr> <td></td> <td>34.0</td> </tr> <tr> <td>85.0</td> <td></td> </tr> </table>		34.0	85.0	
				Liner/ Sleeve																																										
Length:	212.0																																													
Outside Ø:	112.0																																													
Flange Ø:	118.0																																													
Flange depth:	8.05 +1.0																																													
	Piston																																													
Length:	109.5																																													
Comp. height:	65.5 -11.1 -20.1																																													
	Rings																																													
Top:	3.0	Ø : Length:																																												
2nd:	2.0																																													
3rd: oil:	2.0 4.5																																													
	34.0																																													
85.0																																														
5,654 cc 6 cyl 100.0 mm Bore Ø																																														
NM-Motorservice Article no./ Artikelnummer/ Modelo número/ статья номер	NM-Motorservice Article no.:	NM-Motorservice Article no.:	NM-Motorservice Article no.:	NM-Motorservice Article no.:	NM-Motorservice Article no.:	NM-Motorservice Article no.:																																								
	LBS 33250 FA	LB 33250 F (water jacket chromed)	KBS 33250 A	KB 33250 A	KR 33250	PB 33250																																								

ENGINE TYPE Motortyp/ tipo de motor/ тип двигателя	LINER KIT Liner Kit/ camisas de los cilindros/ Лайнер комплект	CYL. LINER Zylinderlaufbuchse/ camisas de los cilindros/ втулка цилиндра	PISTON + RINGS Kolben + Ringe/ Pistón + Anillos/ поршень и кольца	PISTON SET Kolben Set/ Pistón Set/ поршневой	RINGS SET Ring Set/ Anillos Set/ кольца	PIN Pin/ Perno/ Пин	
FD6 3 Rings		Liner/ Sleeve	Piston		Rings		
		Length: Outside Ø: Flange Ø: Flange depth:	212.0 112.0 118.0 8.05 +1.0	Length: Comp. height:	109.5 65.5 -10.2 -18.5	Top: 2nd: oil:	3.0 2.0 4.5
5,654 cc 6 cyl 100.0 mm Bore Ø		Reference no.:	Reference no.:	Reference no.:	Reference no.:	Reference no.:	
		11012-Z5001 11012-Z5020 11012-Z5508 11012-Z5509 11012-Z5512/6 11012-Z5573	O-Ring: 11026-Z5001		12040-Z5005 12040-Z5028	12030-Z5000	
NM-Motorservice Article no./ Artikelnummer/ Modelo número/ статья номер	NM-Motorservice Article no.:	NM-Motorservice Article no.:	NM-Motorservice Article no.:	NM-Motorservice Article no.:	NM-Motorservice Article no.:	NM-Motorservice Article no.:	
	LBS 33300 FA	LB 33300 F (water jacket chromed)	KBS 33300 A	KB 33300 A	KR 33300	PB 33300	



ENGINE TYPE Motortyp/ tipo de motor/ тип двигателя	LINER KIT Liner Kit/ camisas de los cilindros/ Лайнер комплект	CYL. LINER Zylinderlaufbuchse/ camisas de los cilindros/ втулка цилиндра	PISTON + RINGS Kolben + Ringe/ Pistón + Anillos/ поршень и кольца	PISTON SET Kolben Set/ Pistón Set/ поршневой	RINGS SET Ring Set/ Anillos Set/ кольца	PIN Pin/ Perno/ Пин	
FD6 3 Rings		Liner/ Sleeve	Piston		Rings		
		Length: Outside Ø: Flange Ø: Flange depth:	212.0 112.0 118.0 8.05 +1.0	Length: Comp. height:	109.5 65.5 -11.0 -21.7	Top: 2nd: oil:	3.0 2.0 4.5
5,654 cc 6 cyl 100.0 mm Bore Ø		Reference no.:	Reference no.:	Reference no.:	Reference no.:	Reference no.:	
		11012-Z5001 11012-Z5020 11012-Z5508 11012-Z5509 11012-Z5512/6 11012-Z5573	O-Ring: 11026-Z5001		12040-Z5005 12040-Z5028	12030-Z5000	
NM-Motorservice Article no./ Artikelnummer/ Modelo número/ статья номер	NM-Motorservice Article no.:	NM-Motorservice Article no.:	NM-Motorservice Article no.:	NM-Motorservice Article no.:	NM-Motorservice Article no.:	NM-Motorservice Article no.:	
	LBS 33350 FA	LB 33350 F (water jacket chromed)	KBS 33350 A	KB 33350 A	KR 33350	PB 33350	



ENGINE TYPE Motortyp/ tipo de motor/ тип двигателя	LINER KIT Liner Kit/ camisas de los cilindros/ Лайнер комплект	CYL. LINER Zylinderlaufbuchse/ camisas de los cilindros/ втулка цилиндра	PISTON + RINGS Kolben + Ringe/ Pistón + Anillos/ поршень и кольца	PISTON SET Kolben Set/ Pistón Set/ поршневой	RINGS SET Ring Set/ Anillos Set/ кольца	PIN Pin/ Perno/ Пин	
FE6		Liner/ Sleeve	Piston		Rings		
		Length: Outside Ø: Flange Ø: Flange depth:	217.0 111.0 116.0 8.0 +0.9	Length: Comp. height:	103.4 65.4 -11.8 -19.4	Top: 2nd: oil:	3.0 2.0 4.0
6,925 cc 6 cyl 108.0 mm Bore Ø		Reference no.:	Reference no.:	Reference no.:	Reference no.:	Reference no.:	
		11012-Z5518		12011-Z5615 12011-Z5801	12040-Z5211 12040-Z5504 12040-Z5511	12030-95000	
NM-Motorservice Article no./ Artikelnummer/ Modelo número/ статья номер	NM-Motorservice Article no.:	NM-Motorservice Article no.:	NM-Motorservice Article no.:	NM-Motorservice Article no.:	NM-Motorservice Article no.:	NM-Motorservice Article no.:	
	LBS 33400 FA	LB 33400 F (phosphated)	KBS 33400 A	KB 33400 A	KR 33400	PB 33400	



ENGINE TYPE Motortyp/ tipo de motor/ тип двигателя	LINER KIT Liner Kit/ camisas de los cilindros/ Лайнер комплект	CYL. LINER Zylinderlaufbuchse/ camisas de los cilindros/ втулка цилиндра	PISTON + RINGS Kolben + Ringe/ Pistón + Anillos/ поршень и кольца	PISTON SET Kolben Set/ Pistón Set/ поршневой	RINGS SET Ring Set/ Anillos Set/ кольца	PIN Pin/ Perno/ Пин	
FE6T 6,925 cc 6 cyl 108.0 mm Bore Ø		Liner/ Sleeve	Piston		Alfin head anodized	Rings	Ø : 36.0 Length: 92.0
		Length: Outside Ø: Flange Ø: Flange depth:	217.0 111.0 116.0 8.0 +0.9	Length: Comp. height:			
		Reference no.:	Reference no.:	Reference no.:	Reference no.:	Reference no.:	
		11012-Z5518		12010-96507 12011-96507 12011-Z5768	12040-Z5505 12040-Z5512 12040-Z5517	12030-95000	
NM-Motorservice Article no./ Artikelnummer/ Modelo número/ статья номер	NM-Motorservice Article no.:	NM-Motorservice Article no.:	NM-Motorservice Article no.:	NM-Motorservice Article no.:	NM-Motorservice Article no.:	NM-Motorservice Article no.:	
	LBS 33450 FA	LB 33450 F (phosphated)	KBS 33450 A	KB 33450 A	KR 33450	PB 33450	

ENGINE TYPE Motortyp/ tipo de motor/ тип двигателя	LINER KIT Liner Kit/ camisas de los cilindros/ Лайнер комплект	CYL. LINER Zylinderlaufbuchse/ camisas de los cilindros/ втулка цилиндра	PISTON + RINGS Kolben + Ringe/ Pistón + Anillos/ поршень и кольца	PISTON SET Kolben Set/ Pistón Set/ поршневой	RINGS SET Ring Set/ Anillos Set/ кольца	PIN Pin/ Perno/ Пин
FE6TA 6,925 cc 6 cyl 108.0 mm Bore Ø		Liner/ Sleeve	Piston		Rings	Ø : 36.0 Length: 93.0
		Length: Outside Ø: Flange Ø: Flange depth:	217.0 111.0 116.0 8.0 +0.9	Length: Comp. height:		
		Reference no.:	Reference no.:	Reference no.:	Reference no.:	Reference no.:
		11012-Z5518		12010-Z5507	12040-Z5519 12040-Z5560 12040-Z5561 12040-Z5564 12040-Z5919	12030-95000
NM-Motorservice Article no./ Artikelnummer/ Modelo número/ статья номер	NM-Motorservice Article no.:	NM-Motorservice Article no.:	NM-Motorservice Article no.:	NM-Motorservice Article no.:	NM-Motorservice Article no.:	NM-Motorservice Article no.:
	LBS 36050 FA	LB 36050 F (phosphated)	KBS 36050 A	KB 36050 A	KR 36050	PB 36050

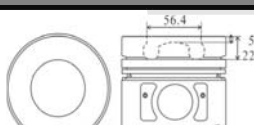
ENGINE TYPE Motortyp/ tipo de motor/ тип двигателя	LINER KIT Liner Kit/ camisas de los cilindros/ Лайнер комплект	CYL. LINER Zylinderlaufbuchse/ camisas de los cilindros/ втулка цилиндра	PISTON + RINGS Kolben + Ringe/ Pistón + Anillos/ поршень и кольца	PISTON SET Kolben Set/ Pistón Set/ поршневой	RINGS SET Ring Set/ Anillos Set/ кольца	PIN Pin/ Perno/ Пин	
FE6T 6,925 cc 6 cyl 108.0 mm Bore Ø		Liner/ Sleeve	Piston		Alfin head anodized	Rings	Ø : 36.0 Length: 90.0
		Length: Outside Ø: Flange Ø: Flange depth:	217.0 111.0 116.0 8.0 +0.9	Length: Comp. height:			
		Reference no.:	Reference no.:	Reference no.:	Reference no.:	Reference no.:	
		11012-Z5518			12040-Z5519 12040-Z5560 12040-Z5561 12040-Z5564 12040-Z5919	12030-95000	
NM-Motorservice Article no./ Artikelnummer/ Modelo número/ статья номер	NM-Motorservice Article no.:	NM-Motorservice Article no.:	NM-Motorservice Article no.:	NM-Motorservice Article no.:	NM-Motorservice Article no.:	NM-Motorservice Article no.:	
	LBS 33550 FA	LB 33550 F (phosphated)	KBS 33550 A	KB 33550 A	KR 33550	PB 33550	

ENGINE TYPE Motortyp/ tipo de motor/ тип двигателя	LINER KIT Liner Kit/ camisas de los cilindros/ Лайнер комплект	CYL. LINER Zylinderlaufbuchse/ camisas de los cilindros/ втулка цилиндра	PISTON + RINGS Kolben + Ringe/ Pistón + Anillos/ поршень и кольца	PISTON SET Kolben Set/ Pistón Set/ поршневой	RINGS SET Ring Set/ Anillos Set/ кольца	PIN Pin/ Perno/ Пин
FE6T New 6,925 cc 6 cyl 108.0 mm Bore Ø		Liner/ Sleeve	Piston	Alfin head anodized pin bushing inserted	Rings	Ø : 36.0 Length: 90.0
		Length: 217.0 Outside Ø: 111.0 Flange Ø: 116.0 Flange depth: 8.0 +0.9	Length: 103.5 Comp. height: 65.5 -21.0			
		Reference no.: 11012-Z5518	Reference no.:	Reference no.: 12010-Z5968 12011-Z5968	Reference no.: 12040-Z5519 12040-Z5560 12040-Z5561 12040-Z5564 12040-Z5919	Reference no.: 12030-95000
NM-Motorservice Article no./ Artikelnummer/ Modelo número/ статья номер	NM-Motorservice Article no.:	NM-Motorservice Article no.:	NM-Motorservice Article no.:	NM-Motorservice Article no.:	NM-Motorservice Article no.:	NM-Motorservice Article no.:
	LBS 33600 FA	LB 33600 F (phosphated)	KBS 33600 A	KB 33600 A	KR 33600	PB 33600

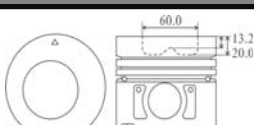
ENGINE TYPE Motortyp/ tipo de motor/ тип двигателя	LINER KIT Liner Kit/ camisas de los cilindros/ Лайнер комплект	CYL. LINER Zylinderlaufbuchse/ camisas de los cilindros/ втулка цилиндра	PISTON + RINGS Kolben + Ringe/ Pistón + Anillos/ поршень и кольца	PISTON SET Kolben Set/ Pistón Set/ поршневой	RINGS SET Ring Set/ Anillos Set/ кольца	PIN Pin/ Perno/ Пин
FE6B 24V LD60A/70A/80A/85A 6,925 cc 6 cyl 108.0 mm Bore Ø		Liner/ Sleeve	Piston	Alfin head anodized	Rings	Ø : 36.0 Length: 92.0
		Length: 217.0 Outside Ø: 111.0 Flange Ø: 116.0 Flange depth: 8.0 +0.9	Length: 103.5 Comp. height: 65.5 -5.9 -22.9			
		Reference no.: 11012-Z5518	Reference no.:	Reference no.: 12013-Z5572	Reference no.: 12040-Z5519 12040-Z5560 12040-Z5561 12040-Z5564 12040-Z5919	Reference no.: 12030-95000
NM-Motorservice Article no./ Artikelnummer/ Modelo número/ статья номер	NM-Motorservice Article no.:	NM-Motorservice Article no.:	NM-Motorservice Article no.:	NM-Motorservice Article no.:	NM-Motorservice Article no.:	NM-Motorservice Article no.:
	LBS 33650 FA	LB 33650 F (phosphated)	KBS 33650 A	KB 33650 A	KR 33650	PB 33650

ENGINE TYPE Motortyp/ tipo de motor/ тип двигателя	LINER KIT Liner Kit/ camisas de los cilindros/ Лайнер комплект	CYL. LINER Zylinderlaufbuchse/ camisas de los cilindros/ втулка цилиндра	PISTON + RINGS Kolben + Ringe/ Pistón + Anillos/ поршень и кольца	PISTON SET Kolben Set/ Pistón Set/ поршневой	RINGS SET Ring Set/ Anillos Set/ кольца	PIN Pin/ Perno/ Пин
FE6T 6,925 cc 6 cyl 108.0 mm Bore Ø		Liner/ Sleeve	Piston		Rings	Ø : 36.0 Length: 93.0
		Length: 217.0 Outside Ø: 111.0 Flange Ø: 116.0 Flange depth: 8.0 +0.9	Length: 104.0 Comp. height: 65.5 -13.2 -20.0			
		Reference no.: 11012-Z5518	Reference no.:	Reference no.:	Reference no.: 12040-Z5519 12040-Z5560 12040-Z5561 12040-Z5564 12040-Z5919	Reference no.: 12030-95000
NM-Motorservice Article no./ Artikelnummer/ Modelo número/ статья номер	NM-Motorservice Article no.:	NM-Motorservice Article no.:	NM-Motorservice Article no.:	NM-Motorservice Article no.:	NM-Motorservice Article no.:	NM-Motorservice Article no.:
	LBS 33700 FA	LB 33700 F (phosphated)	KBS 33700 A	KB 33700 A	KR 33700	PB 33700

ENGINE TYPE Motortyp/ tipo de motor/ тип двигателя	LINER KIT Liner Kit/ camisas de los cilindros/ Лайнер комплект	CYL. LINER Zylinderlaufbuchse/ camisas de los cilindros/ втулка цилиндра	PISTON + RINGS Kolben + Ringe/ Pistón + Anillos/ поршень и кольца	PISTON SET Kolben Set/ Pistón Set/ поршневой	RINGS SET Ring Set/ Anillos Set/ кольца	PIN Pin/ Perno/ Пин	
FE6T 6,925 cc 6 cyl 108.0 mm Bore Ø		Liner/ Sleeve	Piston		Alfin head anodized	Rings	Ø : 36.0 Length: 93.0
		Length: Outside Ø: Flange Ø: Flange depth:	217.0 111.0 116.0 8.0 +0.9	Length: Comp. height:			
		Reference no.:	Reference no.:	Reference no.:	Reference no.:	Reference no.:	
		11012-Z5518		12011-Z5776	12040-Z5519 12040-Z5560 12040-Z5561 12040-Z5564 12040-Z5919	12030-95000	
NM-Motorservice Article no./ Artikelnummer/ Modelo número/ статья номер	NM-Motorservice Article no.:	NM-Motorservice Article no.:	NM-Motorservice Article no.:	NM-Motorservice Article no.:	NM-Motorservice Article no.:	NM-Motorservice Article no.:	
	LBS 33750 FA	LB 33750 F (phosphated)	KBS 33750 A	KB 33750 A	KR 33750	PB 33750	

ENGINE TYPE Motortyp/ tipo de motor/ тип двигателя	LINER KIT Liner Kit/ camisas de los cilindros/ Лайнер комплект	CYL. LINER Zylinderlaufbuchse/ camisas de los cilindros/ втулка цилиндра	PISTON + RINGS Kolben + Ringe/ Pistón + Anillos/ поршень и кольца	PISTON SET Kolben Set/ Pistón Set/ поршневой	RINGS SET Ring Set/ Anillos Set/ кольца	PIN Pin/ Perno/ Пин
ND6 6,842 cc 6 cyl 110.0 mm Bore Ø		Liner/ Sleeve	Piston		Rings	Ø : 36.0 Length: 94.7
		Length: Outside Ø: Flange Ø: Flange depth:	229.0 115.0 118.9 3.0 +1.0	Length: Comp. height:		
		Reference no.:	Reference no.:	Reference no.:	Reference no.:	Reference no.:
		11012-95001 11012-95002		12011-95000	12040-90127 12040-95006 12040-95025	12030-95000
NM-Motorservice Article no./ Artikelnummer/ Modelo número/ статья номер	NM-Motorservice Article no.:	NM-Motorservice Article no.:	NM-Motorservice Article no.:	NM-Motorservice Article no.:	NM-Motorservice Article no.:	NM-Motorservice Article no.:
	LBS 33800 F	LB 33800 F	KBS 33800	KB 33800	KR 33800	PB 33800

ENGINE TYPE Motortyp/ tipo de motor/ тип двигателя	LINER KIT Liner Kit/ camisas de los cilindros/ Лайнер комплект	CYL. LINER Zylinderlaufbuchse/ camisas de los cilindros/ втулка цилиндра	PISTON + RINGS Kolben + Ringe/ Pistón + Anillos/ поршень и кольца	PISTON SET Kolben Set/ Pistón Set/ поршневой	RINGS SET Ring Set/ Anillos Set/ кольца	PIN Pin/ Perno/ Пин
NE6 7,412 cc 6 cyl 110.0 mm Bore Ø		Liner/ Sleeve	Piston		Rings	Ø : 36.0 Length: 95.0
		Length: Outside Ø: Flange Ø: Flange depth:	229.0 115.0 118.9 3.0 +1.0	Length: Comp. height:		
		Reference no.:	Reference no.:	Reference no.:	Reference no.:	Reference no.:
		11012-95001 11012-95002		12011-95073 12011-95105	12040-95012 12040-95013 12040-95014 12040-95016 12040-95029 12040-95125	12030-95000
NM-Motorservice Article no./ Artikelnummer/ Modelo número/ статья номер	NM-Motorservice Article no.:	NM-Motorservice Article no.:	NM-Motorservice Article no.:	NM-Motorservice Article no.:	NM-Motorservice Article no.:	NM-Motorservice Article no.:
	LBS 33850 FA	LB 33850 F	KBS 33850 A	KB 33850 A	KR 33850	PB 33850

ENGINE TYPE Motortyp/ tipo de motor/ тип двигателя	LINER KIT Liner Kit/ camisas de los cilindros/ Лайнер комплект	CYL. LINER Zylinderlaufbuchse/ camisas de los cilindros/ втулка цилиндра	PISTON + RINGS Kolben + Ringe/ Pistón + Anillos/ поршень и кольца	PISTON SET Kolben Set/ Pistón Set/ поршневой	RINGS SET Ring Set/ Anillos Set/ кольца	PIN Pin/ Perno/ Пин																																					
NE6T		<table border="1"> <tr> <td></td> <td>Liner/ Sleeve</td> <td></td> </tr> <tr> <td>Length:</td> <td>229.0</td> <td></td> </tr> <tr> <td>Outside Ø:</td> <td>115.0</td> <td></td> </tr> <tr> <td>Flange Ø:</td> <td>120.9</td> <td></td> </tr> <tr> <td>Flange depth:</td> <td>3.0</td> <td>+1.0</td> </tr> </table>		Liner/ Sleeve		Length:	229.0		Outside Ø:	115.0		Flange Ø:	120.9		Flange depth:	3.0	+1.0	<table border="1"> <tr> <td colspan="2">Piston</td> </tr> <tr> <td>Length:</td> <td>110.2</td> </tr> <tr> <td>Comp. height:</td> <td>68.3</td> </tr> <tr> <td></td> <td>-13.0</td> </tr> <tr> <td></td> <td>-21.0</td> </tr> </table>	Piston		Length:	110.2	Comp. height:	68.3		-13.0		-21.0		<table border="1"> <tr> <td colspan="2">Rings</td> </tr> <tr> <td>Top:</td> <td>3.0</td> </tr> <tr> <td>2nd:</td> <td>2.5</td> </tr> <tr> <td>oil:</td> <td>4.0</td> </tr> </table>	Rings		Top:	3.0	2nd:	2.5	oil:	4.0	<table border="1"> <tr> <td>Ø:</td> <td>36.0</td> </tr> <tr> <td>Length:</td> <td>95.0</td> </tr> </table>	Ø:	36.0	Length:	95.0
				Liner/ Sleeve																																							
Length:	229.0																																										
Outside Ø:	115.0																																										
Flange Ø:	120.9																																										
Flange depth:	3.0	+1.0																																									
Piston																																											
Length:	110.2																																										
Comp. height:	68.3																																										
	-13.0																																										
	-21.0																																										
Rings																																											
Top:	3.0																																										
2nd:	2.5																																										
oil:	4.0																																										
Ø:	36.0																																										
Length:	95.0																																										
7,412 cc 6 cyl 110.0 mm Bore Ø																																											
NM-Motorservice Article no./ Artikelnummer/ Modelo número/ статья номер	NM-Motorservice Article no.:	NM-Motorservice Article no.:	NM-Motorservice Article no.:	NM-Motorservice Article no.:	NM-Motorservice Article no.:	NM-Motorservice Article no.:																																					
	LBS 33900 FA	LB 33900 F (phosphated)	KBS 33900 A	KB 33900 A	KR 33900	PB 33900																																					

ENGINE TYPE Motortyp/ tipo de motor/ тип двигателя	LINER KIT Liner Kit/ camisas de los cilindros/ Лайнер комплект	CYL. LINER Zylinderlaufbuchse/ camisas de los cilindros/ втулка цилиндра	PISTON + RINGS Kolben + Ringe/ Pistón + Anillos/ поршень и кольца	PISTON SET Kolben Set/ Pistón Set/ поршневой	RINGS SET Ring Set/ Anillos Set/ кольца	PIN Pin/ Perno/ Пин																																	
NF6T		<table border="1"> <tr> <td></td> <td>Liner/ Sleeve</td> <td></td> </tr> <tr> <td>Length:</td> <td>226.0</td> <td></td> </tr> <tr> <td>Outside Ø:</td> <td>123.0</td> <td></td> </tr> <tr> <td>Flange Ø:</td> <td>129.0</td> <td></td> </tr> <tr> <td>Flange depth:</td> <td>8.0</td> <td></td> </tr> </table>		Liner/ Sleeve		Length:	226.0		Outside Ø:	123.0		Flange Ø:	129.0		Flange depth:	8.0		<table border="1"> <tr> <td colspan="2">Piston</td> </tr> <tr> <td>Length:</td> <td>116.3</td> </tr> <tr> <td>Comp. height:</td> <td>71.3</td> </tr> </table>	Piston		Length:	116.3	Comp. height:	71.3		<table border="1"> <tr> <td colspan="2">Rings</td> </tr> <tr> <td>Top:</td> <td>3.0</td> </tr> <tr> <td>2nd:</td> <td>2.5</td> </tr> <tr> <td>oil:</td> <td>4.0</td> </tr> </table>	Rings		Top:	3.0	2nd:	2.5	oil:	4.0	<table border="1"> <tr> <td>Ø:</td> <td>44.0</td> </tr> <tr> <td>Length:</td> <td>101.0</td> </tr> </table>	Ø:	44.0	Length:	101.0
				Liner/ Sleeve																																			
Length:	226.0																																						
Outside Ø:	123.0																																						
Flange Ø:	129.0																																						
Flange depth:	8.0																																						
Piston																																							
Length:	116.3																																						
Comp. height:	71.3																																						
Rings																																							
Top:	3.0																																						
2nd:	2.5																																						
oil:	4.0																																						
Ø:	44.0																																						
Length:	101.0																																						
9,160 cc 6 cyl 120.0 mm Bore Ø																																							
NM-Motorservice Article no./ Artikelnummer/ Modelo número/ статья номер	NM-Motorservice Article no.:	NM-Motorservice Article no.:	NM-Motorservice Article no.:	NM-Motorservice Article no.:	NM-Motorservice Article no.:	NM-Motorservice Article no.:																																	
	LBS 33950 FA	LB 33950 F (phosphated)	KBS 33950 A	KB 33950 A	KR 33950	PB 33950																																	

ENGINE TYPE Motortyp/ tipo de motor/ тип двигателя	LINER KIT Liner Kit/ camisas de los cilindros/ Лайнер комплект	CYL. LINER Zylinderlaufbuchse/ camisas de los cilindros/ втулка цилиндра	PISTON + RINGS Kolben + Ringe/ Pistón + Anillos/ поршень и кольца	PISTON SET Kolben Set/ Pistón Set/ поршневой	RINGS SET Ring Set/ Anillos Set/ кольца	PIN Pin/ Perno/ Пин																																					
PD6		<table border="1"> <tr> <td></td> <td>Liner/ Sleeve</td> <td></td> </tr> <tr> <td>Length:</td> <td>259.0</td> <td></td> </tr> <tr> <td>Outside Ø:</td> <td>130.0</td> <td></td> </tr> <tr> <td>Flange Ø:</td> <td>134.0</td> <td></td> </tr> <tr> <td>Flange depth:</td> <td>3.0</td> <td>+1.0</td> </tr> </table>		Liner/ Sleeve		Length:	259.0		Outside Ø:	130.0		Flange Ø:	134.0		Flange depth:	3.0	+1.0	<table border="1"> <tr> <td colspan="2">Piston</td> </tr> <tr> <td>Length:</td> <td>132.0</td> </tr> <tr> <td>Comp. height:</td> <td>82.0</td> </tr> <tr> <td></td> <td>-13.4</td> </tr> <tr> <td></td> <td>-30.0</td> </tr> </table>	Piston		Length:	132.0	Comp. height:	82.0		-13.4		-30.0		<table border="1"> <tr> <td colspan="2">Rings</td> </tr> <tr> <td>Top:</td> <td>5.0</td> </tr> <tr> <td>2nd:</td> <td>3.5</td> </tr> <tr> <td>oil:</td> <td>5.0</td> </tr> </table>	Rings		Top:	5.0	2nd:	3.5	oil:	5.0	<table border="1"> <tr> <td>Ø:</td> <td>46.0</td> </tr> <tr> <td>Length:</td> <td>108.0</td> </tr> </table>	Ø:	46.0	Length:	108.0
				Liner/ Sleeve																																							
Length:	259.0																																										
Outside Ø:	130.0																																										
Flange Ø:	134.0																																										
Flange depth:	3.0	+1.0																																									
Piston																																											
Length:	132.0																																										
Comp. height:	82.0																																										
	-13.4																																										
	-30.0																																										
Rings																																											
Top:	5.0																																										
2nd:	3.5																																										
oil:	5.0																																										
Ø:	46.0																																										
Length:	108.0																																										
10,308 cc 6 cyl 125.0 mm Bore Ø																																											
NM-Motorservice Article no./ Artikelnummer/ Modelo número/ статья номер	NM-Motorservice Article no.:	NM-Motorservice Article no.:	NM-Motorservice Article no.:	NM-Motorservice Article no.:	NM-Motorservice Article no.:	NM-Motorservice Article no.:																																					
	LBS 36450 FA superseded by LBS 34050 FA	LB 36450 F	KBS 36450 A superseded by LB 34050 A	KB 36450 A	KR 36450	PB 36450																																					

ENGINE TYPE Motortyp/ tipo de motor/ тип двигателя	LINER KIT Liner Kit/ camisas de los cilindros/ Лайнер комплект	CYL. LINER Zylinderlaufbuchse/ camisas de los cilindros/ втулка цилиндра	PISTON + RINGS Kolben + Ringe/ Pistón + Anillos/ поршень и кольца	PISTON SET Kolben Set/ Pistón Set/ поршневой	RINGS SET Ring Set/ Anillos Set/ кольца	PIN Pin/ Perno/ Пин																																		
PD6T		<table border="1"> <tr> <td></td> <td>Liner/ Sleeve</td> <td></td> </tr> <tr> <td>Length:</td> <td>259.0</td> <td></td> </tr> <tr> <td>Outside Ø:</td> <td>130.0</td> <td></td> </tr> <tr> <td>Flange Ø:</td> <td>134.0</td> <td></td> </tr> <tr> <td>Flange depth:</td> <td>3.0 +1.0</td> <td></td> </tr> </table>		Liner/ Sleeve		Length:	259.0		Outside Ø:	130.0		Flange Ø:	134.0		Flange depth:	3.0 +1.0		<table border="1"> <tr> <td></td> <td>Piston</td> <td></td> </tr> <tr> <td>Length:</td> <td>132.0</td> <td></td> </tr> <tr> <td>Comp. height:</td> <td>82.0 -12.5 -28.2</td> <td></td> </tr> </table>		Piston		Length:	132.0		Comp. height:	82.0 -12.5 -28.2			<table border="1"> <tr> <td></td> <td>Rings</td> <td></td> </tr> <tr> <td>Top:</td> <td>4.0</td> <td rowspan="3">Ø : 46.0 Length: 107.5</td> </tr> <tr> <td>2nd:</td> <td>3.5</td> </tr> <tr> <td>oil:</td> <td>5.0</td> </tr> </table>		Rings		Top:	4.0	Ø : 46.0 Length: 107.5	2nd:	3.5	oil:	5.0	
				Liner/ Sleeve																																				
Length:	259.0																																							
Outside Ø:	130.0																																							
Flange Ø:	134.0																																							
Flange depth:	3.0 +1.0																																							
	Piston																																							
Length:	132.0																																							
Comp. height:	82.0 -12.5 -28.2																																							
	Rings																																							
Top:	4.0	Ø : 46.0 Length: 107.5																																						
2nd:	3.5																																							
oil:	5.0																																							
10,308 cc 6 cyl 125.0 mm Bore Ø																																								
		Reference no.:	Reference no.:	Reference no.:	Reference no.:	Reference no.:																																		
							11012-96000 11012-96001	12011-96005 12011-96009	12040-90228 12040-96005 12040-96125 12040-96129	12030-96000 12030-96001																														
NM-Motorservice Article no./ Artikelnummer/ Modelo número/ статья номер	NM-Motorservice Article no.:	NM-Motorservice Article no.:	NM-Motorservice Article no.:	NM-Motorservice Article no.:	NM-Motorservice Article no.:	NM-Motorservice Article no.:																																		
	LBS 34050 FA	LB 34050 F	KBS 34050 A	KB 34050 A	KR 34050	PB 34050																																		

ENGINE TYPE Motortyp/ tipo de motor/ тип двигателя	LINER KIT Liner Kit/ camisas de los cilindros/ Лайнер комплект	CYL. LINER Zylinderlaufbuchse/ camisas de los cilindros/ втулка цилиндра	PISTON + RINGS Kolben + Ringe/ Pistón + Anillos/ поршень и кольца	PISTON SET Kolben Set/ Pistón Set/ поршневой	RINGS SET Ring Set/ Anillos Set/ кольца	PIN Pin/ Perno/ Пин																																		
PE6		<table border="1"> <tr> <td></td> <td>Liner/ Sleeve</td> <td></td> </tr> <tr> <td>Length:</td> <td>259.0</td> <td></td> </tr> <tr> <td>Outside Ø:</td> <td>138.0</td> <td></td> </tr> <tr> <td>Flange Ø:</td> <td>142.0</td> <td></td> </tr> <tr> <td>Flange depth:</td> <td>3.0 +1.0</td> <td></td> </tr> </table>		Liner/ Sleeve		Length:	259.0		Outside Ø:	138.0		Flange Ø:	142.0		Flange depth:	3.0 +1.0		<table border="1"> <tr> <td></td> <td>Piston</td> <td></td> </tr> <tr> <td>Length:</td> <td>132.0</td> <td></td> </tr> <tr> <td>Comp. height:</td> <td>82.0 -15.4 -32.4</td> <td></td> </tr> </table>		Piston		Length:	132.0		Comp. height:	82.0 -15.4 -32.4			<table border="1"> <tr> <td></td> <td>Rings</td> <td></td> </tr> <tr> <td>Top:</td> <td>4.0</td> <td rowspan="3">Ø : 46.0 Length: 116.0</td> </tr> <tr> <td>2nd:</td> <td>3.5</td> </tr> <tr> <td>oil:</td> <td>6.0</td> </tr> </table>		Rings		Top:	4.0	Ø : 46.0 Length: 116.0	2nd:	3.5	oil:	6.0	
				Liner/ Sleeve																																				
Length:	259.0																																							
Outside Ø:	138.0																																							
Flange Ø:	142.0																																							
Flange depth:	3.0 +1.0																																							
	Piston																																							
Length:	132.0																																							
Comp. height:	82.0 -15.4 -32.4																																							
	Rings																																							
Top:	4.0	Ø : 46.0 Length: 116.0																																						
2nd:	3.5																																							
oil:	6.0																																							
11,670 cc 6 cyl 133.0 mm Bore Ø																																								
		Reference no.:	Reference no.:	Reference no.:	Reference no.:	Reference no.:																																		
							11012-96500 11012-96501 11012-96566	12011-96508 12011-96516	12040-96028 12040-96128 12040-96500 12040-96503	12030-96000 12030-96001																														
NM-Motorservice Article no./ Artikelnummer/ Modelo número/ статья номер	NM-Motorservice Article no.:	NM-Motorservice Article no.:	NM-Motorservice Article no.:	NM-Motorservice Article no.:	NM-Motorservice Article no.:	NM-Motorservice Article no.:																																		
	LBS 34100 FA	LB 34100 F	KBS 34100 A	KB 34100 A	KR 34100	PB 34100																																		

ENGINE TYPE Motortyp/ tipo de motor/ тип двигателя	LINER KIT Liner Kit/ camisas de los cilindros/ Лайнер комплект	CYL. LINER Zylinderlaufbuchse/ camisas de los cilindros/ втулка цилиндра	PISTON + RINGS Kolben + Ringe/ Pistón + Anillos/ поршень и кольца	PISTON SET Kolben Set/ Pistón Set/ поршневой	RINGS SET Ring Set/ Anillos Set/ кольца	PIN Pin/ Perno/ Пин																																		
PE6T		<table border="1"> <tr> <td></td> <td>Liner/ Sleeve</td> <td></td> </tr> <tr> <td>Length:</td> <td>259.0</td> <td></td> </tr> <tr> <td>Outside Ø:</td> <td>138.0</td> <td></td> </tr> <tr> <td>Flange Ø:</td> <td>142.0</td> <td></td> </tr> <tr> <td>Flange depth:</td> <td>3.0 +1.0</td> <td></td> </tr> </table>		Liner/ Sleeve		Length:	259.0		Outside Ø:	138.0		Flange Ø:	142.0		Flange depth:	3.0 +1.0		<table border="1"> <tr> <td></td> <td>Piston</td> <td></td> </tr> <tr> <td>Length:</td> <td>132.0</td> <td></td> </tr> <tr> <td>Comp. height:</td> <td>82.0 -15.4 -32.4</td> <td></td> </tr> </table>		Piston		Length:	132.0		Comp. height:	82.0 -15.4 -32.4			<table border="1"> <tr> <td></td> <td>Rings</td> <td></td> </tr> <tr> <td>Top:</td> <td>4.0</td> <td rowspan="3">Ø : 46.0 Length: 116.0</td> </tr> <tr> <td>2nd:</td> <td>3.5</td> </tr> <tr> <td>oil:</td> <td>6.0</td> </tr> </table>		Rings		Top:	4.0	Ø : 46.0 Length: 116.0	2nd:	3.5	oil:	6.0	
				Liner/ Sleeve																																				
Length:	259.0																																							
Outside Ø:	138.0																																							
Flange Ø:	142.0																																							
Flange depth:	3.0 +1.0																																							
	Piston																																							
Length:	132.0																																							
Comp. height:	82.0 -15.4 -32.4																																							
	Rings																																							
Top:	4.0	Ø : 46.0 Length: 116.0																																						
2nd:	3.5																																							
oil:	6.0																																							
6 cc 11,670 cyl 133.0 mm Bore Ø																																								
		Reference no.:	Reference no.:	Reference no.:	Reference no.:	Reference no.:																																		
							11012-96500 11012-96501 11012-96566	12011-96509 12011-96776	12040-96504 12040-96509 12040-96513 12040-96518	12030-96000 12030-96001																														
NM-Motorservice Article no./ Artikelnummer/ Modelo número/ статья номер	NM-Motorservice Article no.:	NM-Motorservice Article no.:	NM-Motorservice Article no.:	NM-Motorservice Article no.:	NM-Motorservice Article no.:	NM-Motorservice Article no.:																																		
	LBS 34150 FA	LB 34150 F	KBS 34150 A	KB 34150 A	KR 34150	PB 34150																																		

ENGINE TYPE Motortyp/ tipo de motor/ тип двигателя	LINER KIT Liner Kit/ camisas de los cilindros/ Лайнер комплект	CYL. LINER Zylinderlaufbuchse/ camisas de los cilindros/ втулка цилиндра	PISTON + RINGS Kolben + Ringe/ Pistón + Anillos/ поршень и кольца	PISTON SET Kolben Set/ Pistón Set/ поршневой	RINGS SET Ring Set/ Anillos Set/ кольца	PIN Pin/ Perno/ Пин																																				
PE6TB		<table border="1"> <tr> <td></td> <td>Liner/ Sleeve</td> <td></td> </tr> <tr> <td>Length:</td> <td>259.0</td> <td></td> </tr> <tr> <td>Outside Ø:</td> <td>138.0</td> <td></td> </tr> <tr> <td>Flange Ø:</td> <td>142.0</td> <td></td> </tr> <tr> <td>Flange depth:</td> <td>3.0 +1.0</td> <td></td> </tr> </table>		Liner/ Sleeve		Length:	259.0		Outside Ø:	138.0		Flange Ø:	142.0		Flange depth:	3.0 +1.0		<table border="1"> <tr> <td></td> <td>Piston</td> <td></td> </tr> <tr> <td>Length:</td> <td>132.0</td> <td></td> </tr> <tr> <td>Comp. height:</td> <td>82.0 -15.3 -32.5</td> <td></td> </tr> </table>		Piston		Length:	132.0		Comp. height:	82.0 -15.3 -32.5		Alfin head anodized	<table border="1"> <tr> <td></td> <td>Rings</td> <td></td> </tr> <tr> <td>Top:</td> <td>3.0</td> <td>Ø:</td> </tr> <tr> <td>2nd: oil:</td> <td>2.5 4.0</td> <td>Length:</td> </tr> <tr> <td></td> <td></td> <td>46.0 116.0</td> </tr> </table>		Rings		Top:	3.0	Ø:	2nd: oil:	2.5 4.0	Length:			46.0 116.0	
				Liner/ Sleeve																																						
Length:	259.0																																									
Outside Ø:	138.0																																									
Flange Ø:	142.0																																									
Flange depth:	3.0 +1.0																																									
	Piston																																									
Length:	132.0																																									
Comp. height:	82.0 -15.3 -32.5																																									
	Rings																																									
Top:	3.0	Ø:																																								
2nd: oil:	2.5 4.0	Length:																																								
		46.0 116.0																																								
11,670 cc 6 cyl 133.0 mm Bore Ø	Reference no.:	Reference no.:	Reference no.:	Reference no.:	Reference no.:																																					
NM-Motorservice Article no./ Artikelnummer/ Modelo número/ статья номер	NM-Motorservice Article no.:	NM-Motorservice Article no.:	NM-Motorservice Article no.:	NM-Motorservice Article no.:	NM-Motorservice Article no.:	NM-Motorservice Article no.:																																				
	LBS 34200 FA	LB 34200 F	KBS 34200 A	KB 34200 A	KR 34200	PB 34200																																				



ENGINE TYPE Motortyp/ tipo de motor/ тип двигателя	LINER KIT Liner Kit/ camisas de los cilindros/ Лайнер комплект	CYL. LINER Zylinderlaufbuchse/ camisas de los cilindros/ втулка цилиндра	PISTON + RINGS Kolben + Ringe/ Pistón + Anillos/ поршень и кольца	PISTON SET Kolben Set/ Pistón Set/ поршневой	RINGS SET Ring Set/ Anillos Set/ кольца	PIN Pin/ Perno/ Пин																																				
PF6TB		<table border="1"> <tr> <td></td> <td>Liner/ Sleeve</td> <td></td> </tr> <tr> <td>Length:</td> <td>259.0</td> <td></td> </tr> <tr> <td>Outside Ø:</td> <td>138.0</td> <td></td> </tr> <tr> <td>Flange Ø:</td> <td>144.0</td> <td></td> </tr> <tr> <td>Flange depth:</td> <td>3.0 +1.2</td> <td></td> </tr> </table>		Liner/ Sleeve		Length:	259.0		Outside Ø:	138.0		Flange Ø:	144.0		Flange depth:	3.0 +1.2		<table border="1"> <tr> <td></td> <td>Piston</td> <td></td> </tr> <tr> <td>Length:</td> <td>136.0</td> <td></td> </tr> <tr> <td>Comp. height:</td> <td>86.1 -12.5 -29.4</td> <td></td> </tr> </table>		Piston		Length:	136.0		Comp. height:	86.1 -12.5 -29.4		Alfin head anodized	<table border="1"> <tr> <td></td> <td>Rings</td> <td></td> </tr> <tr> <td>Top:</td> <td>2.5</td> <td>Ø:</td> </tr> <tr> <td>2nd: oil:</td> <td>2.5 4.0</td> <td>Length:</td> </tr> <tr> <td></td> <td></td> <td>50.0 113.0</td> </tr> </table>		Rings		Top:	2.5	Ø:	2nd: oil:	2.5 4.0	Length:			50.0 113.0	
				Liner/ Sleeve																																						
Length:	259.0																																									
Outside Ø:	138.0																																									
Flange Ø:	144.0																																									
Flange depth:	3.0 +1.2																																									
	Piston																																									
Length:	136.0																																									
Comp. height:	86.1 -12.5 -29.4																																									
	Rings																																									
Top:	2.5	Ø:																																								
2nd: oil:	2.5 4.0	Length:																																								
		50.0 113.0																																								
12,503 cc 6 cyl 133.0 mm Bore Ø	Reference no.:	Reference no.:	Reference no.:	Reference no.:	Reference no.:																																					
NM-Motorservice Article no./ Artikelnummer/ Modelo número/ статья номер	NM-Motorservice Article no.:	NM-Motorservice Article no.:	NM-Motorservice Article no.:	NM-Motorservice Article no.:	NM-Motorservice Article no.:	NM-Motorservice Article no.:																																				
	LBS 34250 FA	LB 34250 F (phosphated)	KBS 34250 A	KB 34250 A	KR 34250	PB 34250																																				

ENGINE TYPE Motortyp/ tipo de motor/ тип двигателя	LINER KIT Liner Kit/ camisas de los cilindros/ Лайнер комплект	CYL. LINER Zylinderlaufbuchse/ camisas de los cilindros/ втулка цилиндра	PISTON + RINGS Kolben + Ringe/ Pistón + Anillos/ поршень и кольца	PISTON SET Kolben Set/ Pistón Set/ поршневой	RINGS SET Ring Set/ Anillos Set/ кольца	PIN Pin/ Perno/ Пин																																				
GE13T		<table border="1"> <tr> <td></td> <td>Liner/ Sleeve</td> <td></td> </tr> <tr> <td>Length:</td> <td></td> <td></td> </tr> <tr> <td>Outside Ø:</td> <td></td> <td></td> </tr> <tr> <td>Flange Ø:</td> <td></td> <td></td> </tr> <tr> <td>Flange depth:</td> <td></td> <td></td> </tr> </table>		Liner/ Sleeve		Length:			Outside Ø:			Flange Ø:			Flange depth:			<table border="1"> <tr> <td></td> <td>Piston</td> <td></td> </tr> <tr> <td>Length:</td> <td></td> <td></td> </tr> <tr> <td>Comp. height:</td> <td></td> <td></td> </tr> </table>		Piston		Length:			Comp. height:			Alfin and with oil gallery	<table border="1"> <tr> <td></td> <td>Rings</td> <td></td> </tr> <tr> <td>Top:</td> <td>2.5</td> <td>Ø:</td> </tr> <tr> <td>2nd: oil:</td> <td>2.0 3.0</td> <td>Length:</td> </tr> <tr> <td></td> <td></td> <td></td> </tr> </table>		Rings		Top:	2.5	Ø:	2nd: oil:	2.0 3.0	Length:				
				Liner/ Sleeve																																						
Length:																																										
Outside Ø:																																										
Flange Ø:																																										
Flange depth:																																										
	Piston																																									
Length:																																										
Comp. height:																																										
	Rings																																									
Top:	2.5	Ø:																																								
2nd: oil:	2.0 3.0	Length:																																								
13,074 cc 6 cyl 136.0 mm Bore Ø	Reference no.:	Reference no.:	Reference no.:	Reference no.:	Reference no.:																																					
NM-Motorservice Article no./ Artikelnummer/ Modelo número/ статья номер	NM-Motorservice Article no.:	NM-Motorservice Article no.:	NM-Motorservice Article no.:	NM-Motorservice Article no.:	NM-Motorservice Article no.:	NM-Motorservice Article no.:																																				
	LBS 34300 FB	LB 34300 F (phosphated)	KBS 34300 B	KB 34300 B	KR 34300	PB 34300																																				

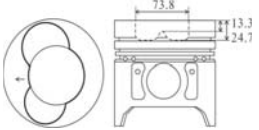

ENGINE TYPE Motortyp/ tipo de motor/ тип двигателя	LINER KIT Liner Kit/ camisas de los cilindros/ Лайнер комплект	CYL. LINER Zylinderlaufbuchse/ camisas de los cilindros/ втулка цилиндра	PISTON + RINGS Kolben + Ringe/ Pistón + Anillos/ поршень и кольца	PISTON SET Kolben Set/ Pistón Set/ поршневой	RINGS SET Ring Set/ Anillos Set/ кольца	PIN Pin/ Perno/ Пин	
RD8 RD10 14,313 cc / 17,892 cc 8/10 cyl 135.0 mm Bore Ø		Liner/ Sleeve	Piston		Rings		
		Length: Outside Ø: Flange Ø: Flange depth:	243.0 152.0 161.0 8.0 +1.0	Length: Comp. height:	137.0 82.0 -13.6 -25.0	Top: 2nd: oil:	4.0 3.0 6.0
		Reference no.:	Reference no.:	Reference no.:	Reference no.:	Reference no.:	
		11012-97001 11012-97025 11012-97063 11012-97077	O-Ring: 1 cyl pack	12010-97004 12010-97006 12010-97012 12010-97079 12011-97004	12040-97007 12040-97126 12040-97127 12040-97527	12030-97000 12030-97001 12030-97002	
NM-Motorservice Article no./ Artikelnummer/ Modelo número/ статья номер	NM-Motorservice Article no.:	NM-Motorservice Article no.:	NM-Motorservice Article no.:	NM-Motorservice Article no.:	NM-Motorservice Article no.:	NM-Motorservice Article no.:	
	LBS 34350-8 FA LBS 34350-10 FA 2 cys pack	LB 34350-8 F LB 34350-10 F 2 cys pack	KBS 34350-8 A KBS 34350-10 A 1 cyl pack	KB 34350-8 A KB 34350-10 A 1 cyl pack	KR 34350-8 KR 34350-10 1 cyl pack	PB 34350-8 PB 34350-10 2 cys pack	

ENGINE TYPE Motortyp/ tipo de motor/ тип двигателя	LINER KIT Liner Kit/ camisas de los cilindros/ Лайнер комплект	CYL. LINER Zylinderlaufbuchse/ camisas de los cilindros/ втулка цилиндра	PISTON + RINGS Kolben + Ringe/ Pistón + Anillos/ поршень и кольца	PISTON SET Kolben Set/ Pistón Set/ поршневой	RINGS SET Ring Set/ Anillos Set/ кольца	PIN Pin/ Perno/ Пин	
RD8T RD10T 14,313 cc / 17,892 cc 8/10 cyl 135.0 mm Bore Ø		Liner/ Sleeve	Piston		Rings		
		Length: Outside Ø: Flange Ø: Flange depth:	243.0 152.0 161.0 8.0 +1.0	Length: Comp. height:	137.0 82.0 -13.5 -25.0	Top: 2nd: oil:	4.0 3.0 6.0
		Reference no.:	Reference no.:	Reference no.:	Reference no.:	Reference no.:	
		11012-97001 11012-97025 11012-97063 11012-97077	O-Ring: 1 cyl pack	12011-97177	12040-97008 12040-97128 12040-97129 12040-97329	12030-97000 12030-97001 12030-97002	
NM-Motorservice Article no./ Artikelnummer/ Modelo número/ статья номер	NM-Motorservice Article no.:	NM-Motorservice Article no.:	NM-Motorservice Article no.:	NM-Motorservice Article no.:	NM-Motorservice Article no.:	NM-Motorservice Article no.:	
	LBS 34400-8 FA LBS 34400-10 FA 2 cys pack	LB 34400-8 F LB 34400-10 F 2 cys pack	KBS 34400-8 A KBS 34400-10 A 1 cyl pack	KB 34400-8 A KB 34400-10 A 1 cyl pack	KR 34400-8 KR 34400-10 1 cyl pack	PB 34400-8 PB 34400-10 2 cys pack	

ENGINE TYPE Motortyp/ tipo de motor/ тип двигателя	LINER KIT Liner Kit/ camisas de los cilindros/ Лайнер комплект	CYL. LINER Zylinderlaufbuchse/ camisas de los cilindros/ втулка цилиндра	PISTON + RINGS Kolben + Ringe/ Pistón + Anillos/ поршень и кольца	PISTON SET Kolben Set/ Pistón Set/ поршневой	RINGS SET Ring Set/ Anillos Set/ кольца	PIN Pin/ Perno/ Пин	
RE8 RE10 15,115 cc / 18,894 cc 8/10 cyl 135.0 mm Bore Ø		Liner/ Sleeve	Piston		Rings		
		Length: Outside Ø: Flange Ø: Flange depth:	238.0 154.9 161.1 11.1 +3.1	Length: Comp. height:	137.0 78.5 -16.1 -27.5	Top: 2nd: oil:	3.0 3.0 5.0
		Reference no.:	Reference no.:	Reference no.:	Reference no.:	Reference no.:	
		11012-97118 11012-97161 11012-97127	O-Ring: 1 cyl pack	12011-97107	12040-97012 12040-97061/8 12040-97074/9 12040-97325 12040-97427 12040-97625	12030-97000 12030-97001 12030-97002	
NM-Motorservice Article no./ Artikelnummer/ Modelo número/ статья номер	NM-Motorservice Article no.:	NM-Motorservice Article no.:	NM-Motorservice Article no.:	NM-Motorservice Article no.:	NM-Motorservice Article no.:	NM-Motorservice Article no.:	
	LBS 34450-8 FA LBS 34450-10 FA 2 cys pack	LB 34450-8 F LB 34450-10 F 2 cys pack	KBS 34450-8 A KBS 34450-10 A 1 cyl pack	KB 34450-8 A KB 34450-10 A 1 cyl pack	KR 34450-8 KR 34450-10 1 cyl pack	PB 34450-8 PB 34450-10 2 cys pack	

ENGINE TYPE Motortyp/ tipo de motor/ тип двигателя	LINER KIT Liner Kit/ camisas de los cilindros/ Лайнер комплект	CYL. LINER Zylinderlaufbuchse/ camisas de los cilindros/ втулка цилиндра		PISTON + RINGS Kolben + Ringe/ Pistón + Anillos/ поршень и кольца		PISTON SET Kolben Set/ Pistón Set/ поршневой	RINGS SET Ring Set/ Anillos Set/ кольца		PIN Pin/ Perno/ Пин	
RF8 (L/R)			Liner/ Sleeve	Piston			Rings		Ø : Length:	46.0 116.0
		Length: Outside Ø: Flange Ø: Flange depth:	238.0 159.0 167.0 11.1 +1.3	Length: Comp. height:	137.0 78.7 -13.3 -24.7		Top: 2nd: oil:	2.5 2.5 4.0		
16,991 cc 8 cyl 138.0 mm Bore Ø		Reference no.:		Reference no.:	Reference no.:	Reference no.:	Reference no.:	Reference no.:		
		11012-97164 11012-97171		O-Ring: 1 cyl pack	12011-97161 12011-97163 12011-97165 (L/R)	12040-97072 12040-97104	12030-97000 12030-97001 12030-97002			
NM-Motorservice Article no./ Artikelnummer/ Modelo número/ статья номер	NM-Motorservice Article no.:	NM-Motorservice Article no.:		NM-Motorservice Article no.:	NM-Motorservice Article no.:	NM-Motorservice Article no.:	NM-Motorservice Article no.:		NM-Motorservice Article no.:	
	LBS 36100 FA 2 cyls pack	LB 36100 F 2 cyls pack		KBS 36100 A 1 cyl pack	KB 36100 A 1 cyl pack	KR 36100 1 cyl pack	PB 36100 2 cyls pack			





ENGINE TYPE Motortyp/ tipo de motor/ тип двигателя	LINER KIT Liner Kit/ camisas de los cilindros/ Лайнер комплект	CYL. LINER Zylinderlaufbuchse/ camisas de los cilindros/ втулка цилиндра		PISTON + RINGS Kolben + Ringe/ Pistón + Anillos/ поршень и кольца		PISTON SET Kolben Set/ Pistón Set/ поршневой	RINGS SET Ring Set/ Anillos Set/ кольца		PIN Pin/ Perno/ Пин		
MD30 1 TON TRUCK 2,663 cc 4 cyl 96.0 mm Bore Ø			Liner/ Sleeve	Piston			Rings		Ø : Length:	30.0 74.0	
		Length: Outside Ø: Flange Ø: Flange depth:	160.0 99.0 105.0 5.0	Length: Comp. height:	86.0 50.3 -0.5 -1.7		Top: 2nd: oil:	86.0 50.3 -0.5 -1.7			
		Reference no.:		Reference no.:		Reference no.:		Reference no.:		Reference no.:	
NM-Motorservice Article no./ Artikelnummer/ Modelo нúmero/ статья номер	NM-Motorservice Article no.:	NM-Motorservice Article no.:		NM-Motorservice Article no.:		NM-Motorservice Article no.:		NM-Motorservice Article no.:		NM-Motorservice Article no.:	
	LBS 41650 FA LBS 41650 SA	LB 41650 F LB 41650		KBS 41650 A		KB 41650 A		KR 41650		PB 41650	





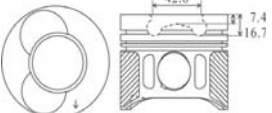

ENGINE TYPE Motortyp/ tipo de motor/ тип двигателя	LINER KIT Liner Kit/ camisas de los cilindros/ Лайнер комплект	CYL. LINER Zylinderlaufbuchse/ camisas de los cilindros/ втулка цилиндра		PISTON + RINGS Kolben + Ringe/ Pistón + Anillos/ поршень и кольца	PISTON SET Kolben Set/ Pistón Set/ поршневой	RINGS SET Ring Set/ Anillos Set/ кольца	PIN Pin/ Perno/ Пин	
D20DT ACTYON 2006- 1,998 cc 4 cyl 86.2 mm Bore Ø			Flanged	No flange	Piston	Alfin and with oil gallery skirt MOS2 treated	Rings	
		Length: Outside Ø: Flange Ø: Flange depth:					Length: Comp. height:	Top: 2nd: oil:
		Reference no.:		Reference no.:	Reference no.:	Reference no.:	Reference no.:	
				664 030 09 17		665 030 05 24	665 038 02 50	
NM-Motorservice Article no./ Artikelnummer/ Modelo número/ статья номер	NM-Motorservice Article no.:	NM-Motorservice Article no.:		NM-Motorservice Article no.:	NM-Motorservice Article no.:	NM-Motorservice Article no.:	NM-Motorservice Article no.:	
	LBS 41700 PB LBS 41700 SB	LB 41700 P LB 41700 S		KBS 41700 B	KB 41700 B	KR 41700	PB 41700	



ENGINE TYPE Motortyp/ tipo de motor/ тип двигателя	LINER KIT Liner Kit/ camisas de los cilindros/ Лайнер комплект	CYL. LINER Zylinderlaufbuchse/ camisas de los cilindros/ втулка цилиндра		PISTON + RINGS Kolben + Ringe/ Pistón + Anillos/ поршень и кольца	PISTON SET Kolben Set/ Pistón Set/ поршневой	RINGS SET Ring Set/ Anillos Set/ кольца	PIN Pin/ Perno/ Пин	
DC 23 KORANDO 2.2 D 2,238 cc 4 cyl 88.0 mm Bore Ø			Liner/ Sleeve		Piston	Rings	Ø: Length:	
		Length: Outside Ø: Flange Ø: Flange depth:	163.0 90.0 95.0 0.9					Length: Comp. height:
		Reference no.:		Reference no.:	Reference no.:	Reference no.:	Reference no.:	
		K-94481960 M-6292390			K-94481600 M-6292300		K-800012041000 M-62923V0	
NM-Motorservice Article no./ Artikelnummer/ Modelo número/ статья номер	NM-Motorservice Article no.:	NM-Motorservice Article no.:		NM-Motorservice Article no.:	NM-Motorservice Article no.:	NM-Motorservice Article no.:	NM-Motorservice Article no.:	
	LBS 41750 CA	LB 41750 C		KBS 41750 A	KB 41750 A	KR 41750	PB 41750	



ENGINE TYPE Motortyp/ tipo de motor/ тип двигателя	LINER KIT Liner Kit/ camisas de los cilindros/ Лайнер комплект	CYL. LINER Zylinderlaufbuchse/ camisas de los cilindros/ втулка цилиндра		PISTON + RINGS Kolben + Ringe/ Pistón + Anillos/ поршень и кольца	PISTON SET Kolben Set/ Pistón Set/ поршневой	RINGS SET Ring Set/ Anillos Set/ кольца	PIN Pin/ Perno/ Пин	
D27DT KYRON REXTON RODIUS 2004- 2,696 cc 5 cyl 86.2 mm Bore Ø			Flanged	No flange	Piston	Alfin and with oil gallery skirt MOS2 treated	Rings	
		Length: Outside Ø: Flange Ø: Flange depth:					Length: Comp. height:	74.6 44.7 -7.4 -17.0
		Reference no.:		Reference no.:	Reference no.:	Reference no.:	Reference no.:	
				665 030 45 17				
NM-Motorservice Article no./ Artikelnummer/ Modelo número/ статья номер	NM-Motorservice Article no.:	NM-Motorservice Article no.:		NM-Motorservice Article no.:	NM-Motorservice Article no.:	NM-Motorservice Article no.:	NM-Motorservice Article no.:	
	LBS 41800 PB LBS 41800 SB	LB 41800 P LB 41800 S		KBS 41800 B	KB 41800B	KR 41800		

ENGINE TYPE Motor/тип de motor/ тип двигателя	LINER KIT Liner Kit/ camisas de los cilindros/ Лайнер комплект	CYL. LINER Zylinderlaufbuchse/ camisas de los cilindros/ втулка цилиндра		PISTON + RINGS Kolben + Ringe/ Pistón + Anillos/ поршень и кольца		PISTON SET Kolben Set/ Pistón Set/ поршневой	RINGS SET Ring Set/ Anillos Set/ кольца		PIN Pin/ Perno/ Пин		
OM602 TURBO OM662 TURBO KORANDO MUSSO REXTON 1996- 2,874 cc 5 cyl 89.0 mm Bore Ø		Length: Outside Ø: Flange Ø: Flange depth:	Liner/ Sleeve	156.5 91.5 94.0 4.7	Piston		Alfin and with oil gallery skirt MOS2 treated	Rings		Ø : Length:	28.0 70.0
					Length: Comp. height:	74.75 44.75 -7.4 -16.7		Top: 2nd: oil:	2.5 2.0 3.0		
	Reference no.:	Reference no.:		Reference no.:		Reference no.:	Reference no.:		Reference no.:		
	K-94823970 M-0010192	K-89456190 M-004WV14		K-94823700 M-0010100 N-8774310000		A-R45080 G-0874310000 K-800017810000 M-00224N0					
NM-Motorservice Article no./ Artikelnummer/ Modelo нúmero/ статья номер	NM-Motorservice Article no.:	NM-Motorservice Article no.:		NM-Motorservice Article no.:		NM-Motorservice Article no.:	NM-Motorservice Article no.:		NM-Motorservice Article no.:		
	LBS 41850 SB	LB 41850 S		KBS 41850 B		KB 41850 B	KR 41850		PB 41850		

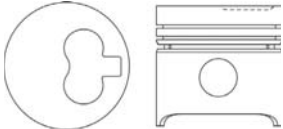

ENGINE TYPE Motor/тип de motor/ тип двигателя	LINER KIT Liner Kit/ camisas de los cilindros/ Лайнер комплект	CYL. LINER Zylinderlaufbuchse/ camisas de los cilindros/ втулка цилиндра			PISTON + RINGS Kolben + Ringe/ Pistón + Anillos/ поршень и кольца		PISTON SET Kolben Set/ Pistón Set/ поршневой	RINGS SET Ring Set/ Anillos Set/ кольца		PIN Pin/ Perno/ Пин	
OM661 OM662 ISTANA KORANDO MUSSO 1986- 2,299 cc / 2,874 cc 4/5 cyl 89.0 mm Bore Ø	Reference no.:	Length: Outside Ø: Flange Ø: Flange depth:	Flanged	No flange	Piston		Alfin skirt MOS2 treated	Rings		Ø : Length:	26.0 62.0
					156.5 91.5 94.0 4.7	156.5 91.5 96.5 4.7		Length: Comp. height:	74.6 44.6 -1.0 -8.9		
	Reference no.:	Reference no.:			Reference no.:		Reference no.:	Reference no.:		Reference no.:	
	LBS 41900 SA Ref. no.: K-91372961 M-0022492 consists of LB 41900 S	LBS 41900 SA Ref. no.: K-91372960 M-0022490 consists of LB 41900-2 S			K-91372600 M-0022400 N-8774310010		A-R45080 G-0874310000 K-800017810000 M-00224N0				
NM-Motorservice Article no./ Artikelnummer/ Modelo нúmero/ статья номер	NM-Motorservice Article no.:	NM-Motorservice Article no.:			NM-Motorservice Article no.:		NM-Motorservice Article no.:	NM-Motorservice Article no.:		NM-Motorservice Article no.:	
	LBS 41900 SA LBA 41900-2 SA	LB 41900 S LB 41900-2 S			KBS 41900 A		KB 41900 A	KR 41900		PB 41900	

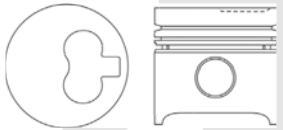

ENGINE TYPE Motor/тип de motor/ тип двигателя	LINER KIT Liner Kit/ camisas de los cilindros/ Лайнер комплект	CYL. LINER Zylinderlaufbuchse/ camisas de los cilindros/ втулка цилиндра			PISTON + RINGS Kolben + Ringe/ Pistón + Anillos/ поршень и кольца		PISTON SET Kolben Set/ Pistón Set/ поршневой	RINGS SET Ring Set/ Anillos Set/ кольца		PIN Pin/ Perno/ Пин	
OM661 OM662 ISTANA KORANDO MUSSO 1986- 2,299 cc / 2,874 cc 4/5 cyl 89.0 mm Bore Ø	Reference no.:	Length: Outside Ø: Flange Ø: Flange depth:	Flanged	No flange	Piston		Alfin skirt MOS2 treated	Rings		Ø : Length:	26.0 62.0
					156.5 91.5 96.5 4.7	156.5 91.5 96.5 4.7		Length: Comp. height:	74.6 44.4 -1.0 -8.9		
	Reference no.:	Reference no.:			Reference no.:		Reference no.:	Reference no.:		Reference no.:	
	K-94675960 M-0022480	K-89429190 M-002WV04			K-94675600 M-0022410		A-R45080 G-0874310000 K-800017810000 M-00224N0				
NM-Motorservice Article no./ Artikelnummer/ Modelo нúmero/ статья номер	NM-Motorservice Article no.:	NM-Motorservice Article no.:			NM-Motorservice Article no.:		NM-Motorservice Article no.:	NM-Motorservice Article no.:		NM-Motorservice Article no.:	
	LBS 41950 SA	LB 41950 S			KBS 41950 A		KB 41950 A	KR 41950		PB 41950	

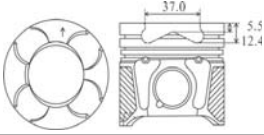

ENGINE TYPE Motortyp/ tipo de motor/ тип двигателя	LINER KIT Liner Kit/ camisas de los cilindros/ Лайнер комплект	CYL. LINER Zylinderlaufbuchse/ camisas de los cilindros/ втулка цилиндра		PISTON + RINGS Kolben + Ringe/ Pistón + Anillos/ поршень и кольца		PISTON SET Kolben Set/ Pistón Set/ поршневой	RINGS SET Ring Set/ Anillos Set/ кольца		PIN Pin/ Perno/ Пин	
XD 3P KORANDO 2.5D also for FORD PEUGEOT 2,498 cc 4 cyl 94.0 mm Bore Ø		Length: Outside Ø: Flange Ø: Flange depth:	Liner/ Sleeve	Piston			Rings		Ø: Length:	30.0 78.8
			165.8 97.0 99.5 3.9	Length: Comp. height:	96.42 53.92 -1.8		Top: 2nd: oil:	2.0 2.0 4.0		
	Reference no.:	Reference no.:		Reference no.:		Reference no.:	Reference no.:		Reference no.:	
	K-93625960 M-0395192	K-89412190 M-039WV30		A-350708 K-93625600 M-0395100 N-8731870010			A-R66140 G-0831870010 K-800004140000 M-03948N0			
NM-Motorservice Article no./ Artikelnummer/ Modelo número/ статья номер	NM-Motorservice Article no.:	NM-Motorservice Article no.:		NM-Motorservice Article no.:		NM-Motorservice Article no.:	NM-Motorservice Article no.:		NM-Motorservice Article no.:	
	LBS 25100 S LBS 25100 SA	LB 42000 S		KBS 25100 KBS 25100 A		KB 25100 KB 25100 A	KR 25100		PB 25100	

ENGINE TYPE Motortyp/ tipo de motor/ тип двигателя	LINER KIT Liner Kit/ camisas de los cilindros/ Лайнер комплект	CYL. LINER Zylinderlaufbuchse/ camisas de los cilindros/ втулка цилиндра		PISTON + RINGS Kolben + Ringe/ Pistón + Anillos/ поршень и кольца		PISTON SET Kolben Set/ Pistón Set/ поршневой	RINGS SET Ring Set/ Anillos Set/ кольца		PIN Pin/ Perno/ Пин	
XD 3T KORANDO 2.5TD 2,498 cc 4 cyl 94.0 mm Bore Ø		Length: Outside Ø: Flange Ø: Flange depth:	Liner/ Sleeve	Piston		Alfin and with oil gallery double keystone skirt MOS2 treated	Rings		Ø: Length:	32.0 78.8
			165.8 97.0 99.5 3.9	Length: Comp. height:	96.37 53.87 -2.27		Top: 2nd: oil:	3.0 2.0 4.0		
	Reference no.:	Reference no.:		Reference no.:		Reference no.:	Reference no.:		Reference no.:	
	K-93608960 M-0394792	K-89412190 M-039WV30		K-93608600 M-0394700			A-R66000 G-0832020010 M-03947N0 M-03952N0			
NM-Motorservice Article no./ Artikelnummer/ Modelo número/ статья номер	NM-Motorservice Article no.:	NM-Motorservice Article no.:		NM-Motorservice Article no.:		NM-Motorservice Article no.:	NM-Motorservice Article no.:		NM-Motorservice Article no.:	
	LBS 42050 SB	LB 42050 S		KBS 42050 B		KB 42050 B	KR 42050		PB 42050	

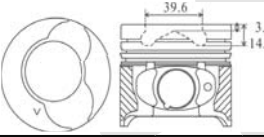

ENGINE TYPE Motortyp/ tipo de motor/ тип двигателя	LINER KIT Liner Kit/ camisas de los cilindros/ Лайнер комплект	CYL. LINER Zylinderlaufbuchse/ camisas de los cilindros/ втулка цилиндра		PISTON + RINGS Kolben + Ringe/ Pistón + Anillos/ поршень и кольца		PISTON SET Kolben Set/ Pistón Set/ поршневой	RINGS SET Ring Set/ Anillos Set/ кольца		PIN Pin/ Perno/ Пин		
Z 13 DT WAGON R DDIS also for SUBARU JUSTY 1.3 TD OPEL 1,248 cc 4 cyl 69.6 mm Bore Ø			Flanged	No flange	Piston		Alfin skirt MOS2 treated	Rings			
		Length:			Length:	63.43		Top:	2.0	Ø:	23.0
		Outside Ø:			Comp. height:	40.43		2nd: oil:	1.5	Length:	56.5
		Flange Ø:			-5.5						
		Flange depth:			-12.4						
		Reference no.:		Reference no.:		Reference no.:	Reference no.:		Reference no.:		
		12111-85E00-0A0 12111-85E00-0B0 12111-85E00-0C0 12111-85E00-040					12140-85E00 12140-85E00-040				
NM-Motorservice Article no./ Artikelnummer/ Modelo número/ статья номер	NM-Motorservice Article no.:	NM-Motorservice Article no.:		NM-Motorservice Article no.:		NM-Motorservice Article no.:	NM-Motorservice Article no.:		NM-Motorservice Article no.:		
	LBS 34550 PA LBS 34550 SA	LB 34550 P LB 34550 S		KBS 34550 A		KB 34550 A	KR 34550		PB 34550		

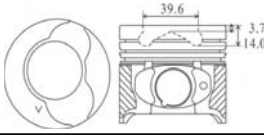

ENGINE TYPE Motortyp/ tipo de motor/ тип двигателя	LINER KIT Liner Kit/ camisas de los cilindros/ Лайнер комплект	CYL. LINER Zylinderlaufbuchse/ camisas de los cilindros/ втулка цилиндра		PISTON + RINGS Kolben + Ringe/ Pistón + Anillos/ поршень и кольца		PISTON SET Kolben Set/ Pistón Set/ поршневой	RINGS SET Ring Set/ Anillos Set/ кольца		PIN Pin/ Perno/ Пин		
K9K 700/766 JIMMY 1.5 DDIS also for RENAULT 1,461 cc 4 cyl 76.0 mm Bore Ø			Flanged	No flange	Piston		Alfin skirt MOS2 treated	Rings			
		Length:	145.0	140.0	Length:	66.0		Top:	2.0	Ø:	25.0
		Outside Ø:	80.5	80.5	Comp. height:	41.78		2nd: oil:	2.0	Length:	60.0
		Flange Ø:			-3.7						
		Flange depth:			-14.0						
		Reference no.:		Reference no.:		Reference no.:	Reference no.:		Reference no.:		
				A-A350603 K-40465600 N-8712340000			A-R60620 G-0812340000 K-800044540000 M-02201N0				
NM-Motorservice Article no./ Artikelnummer/ Modelo número/ статья номер	NM-Motorservice Article no.:	NM-Motorservice Article no.:		NM-Motorservice Article no.:		NM-Motorservice Article no.:	NM-Motorservice Article no.:		NM-Motorservice Article no.:		
	LBS 34600 PA LBS 34600 SA	LB 34600 P LB 34600 S		KBS 34600 A		KB 34600 A	KR 34600		PB 34600		

ENGINE TYPE Motortyp/ tipo de motor/ тип двигателя	LINER KIT Liner Kit/ camisas de los cilindros/ Лайнер комплект	CYL. LINER Zylinderlaufbuchse/ camisas de los cilindros/ втулка цилиндра		PISTON + RINGS Kolben + Ringe/ Pistón + Anillos/ поршень и кольца		PISTON SET Kolben Set/ Pistón Set/ поршневой	RINGS SET Ring Set/ Anillos Set/ кольца		PIN Pin/ Perno/ Пин		
K9K 700/766 JIMMY 1.5 DDIS also for RENAULT 1,461 cc 4 cyl 76.0 mm Bore Ø			Flanged	No flange	Piston		Alfin skirt MOS2 treated	Rings			
		Length:	145.0	140.0	Length:	66.0		Top:	2.0	Ø:	26.0
		Outside Ø:	80.5	80.5	Comp. height:	41.78		2nd: oil:	2.0	Length:	60.0
		Flange Ø:			-3.7						
		Flange depth:			-14.0						
		Reference no.:		Reference no.:		Reference no.:	Reference no.:		Reference no.:		
				A-A354068 K-40190600 M-0220100 N-8712340010			A-R60620 G-0812340000 K-800044540000 M-02201N0				
NM-Motorservice Article no./ Artikelnummer/ Modelo número/ статья номер	NM-Motorservice Article no.:	NM-Motorservice Article no.:		NM-Motorservice Article no.:		NM-Motorservice Article no.:	NM-Motorservice Article no.:		NM-Motorservice Article no.:		
	LBS 34650 PA LBS 34650 SA	LB 34650 P LB 34650 S		KBS 34650 A		KB 34650 A	KR 34650		PB 34650		



ENGINE TYPE Motortyp/ tipo de motor/ тип двигателя	LINER KIT Liner Kit/ camisas de los cilindros/ Лайнер комплект	CYL. LINER Zylinderlaufbuchse/ camisas de los cilindros/ втулка цилиндра	PISTON + RINGS Kolben + Ringe/ Pistón + Anillos/ поршень и кольца	PISTON SET Kolben Set/ Pistón Set/ поршневой	RINGS SET Ring Set/ Anillos Set/ кольца	PIN Pin/ Perno/ Пин		
D19AA also for ALFA ROMEO 1,910 cc 4 cyl 82.0 mm Bore Ø		Liner/ Sleeve	Piston		Alfin skirt MOS2 treated pin bushing inserted	Rings		
		Length: Outside Ø: Flange Ø: Flange depth:	155.0 85.0 88.0 4.5			Length: Comp. height:	72.5 46.5 -0.5 -17.5	Top: 2nd: oil:
		Reference no.:	Reference no.:	Reference no.:	Reference no.:	Reference no.:		
		G-1402896000	A-A354067 K-40218600 K-99724600 M-0101500 N-8712400030		A-R67925 G-0812400000 G-0814610000 K-800072610000 K-800073040000 M-00981N0			
NM-Motorservice Article no./ Artikelnummer/ Modelo número/ статья номер	NM-Motorservice Article no.:	NM-Motorservice Article no.:	NM-Motorservice Article no.:	NM-Motorservice Article no.:	NM-Motorservice Article no.:	NM-Motorservice Article no.:		
	LBS 34700 SA	LB 34700 S	KBS 34700 A	KB 34700 A	KR 34700			

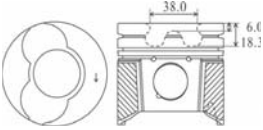

ENGINE TYPE Motortyp/ tipo de motor/ тип двигателя	LINER KIT Liner Kit/ camisas de los cilindros/ Лайнер комплект	CYL. LINER Zylinderlaufbuchse/ camisas de los cilindros/ втулка цилиндра	PISTON + RINGS Kolben + Ringe/ Pistón + Anillos/ поршень и кольца	PISTON SET Kolben Set/ Pistón Set/ поршневой	RINGS SET Ring Set/ Anillos Set/ кольца	PIN Pin/ Perno/ Пин		
XUD 9A SAMURAI VITARA 1.9 D also for PEUGEOT 1,905 cc 4 cyl 83.0 mm Bore Ø		Flanged	No flange	Piston		Rings		
		Length: Outside Ø: Flange Ø: Flange depth:	153.5 86.0 89.0 4.8	153.5 86.0	Length: Comp. height:	84.3 46.8 -2.2	Top: 2nd: oil:	2.0 2.0 3.0
		Reference no.:	Reference no.:	Reference no.:	Reference no.:	Reference no.:		
		K-93648970 M-0392490 M-0392491	K-89184190 M-039WV21 M-039WV32	A-350709 K-93648700 M-0392400 N-8715200010		A-R66390 G-0815200000 K-800003740000 M-03924N0		
NM-Motorservice Article no./ Artikelnummer/ Modelo número/ статья номер	NM-Motorservice Article no.:	NM-Motorservice Article no.:	NM-Motorservice Article no.:	NM-Motorservice Article no.:	NM-Motorservice Article no.:	NM-Motorservice Article no.:		
	LBS 34750 P LBS 34750 S	LB 34750 P LB 34750 S	KBS 34750	KB 34750	KR 34750	PB 34750		

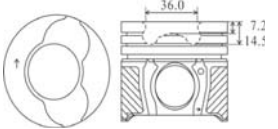

ENGINE TYPE Motortyp/ tipo de motor/ тип двигателя	LINER KIT Liner Kit/ camisas de los cilindros/ Лайнер комплект	CYL. LINER Zylinderlaufbuchse/ camisas de los cilindros/ втулка цилиндра	PISTON + RINGS Kolben + Ringe/ Pistón + Anillos/ поршень и кольца	PISTON SET Kolben Set/ Pistón Set/ поршневой	RINGS SET Ring Set/ Anillos Set/ кольца	PIN Pin/ Perno/ Пин			
XUD 9SE BALENO 1.9 TD also for PEUGEOT 1,905 cc 4 cyl 83.0 mm Bore Ø		Flanged	No flange	Piston		Rings			
		Length: Outside Ø: Flange Ø: Flange depth:	153.5 86.0 89.0 4.8	153.5 86.0	Length: Comp. height:	79.3 46.8 -3.5	Alfin head anodized skirt MOS2 treated	Top: 2nd: oil:	3.0 2.0 3.0
		Reference no.:	Reference no.:	Reference no.:	Reference no.:	Reference no.:			
		K-89184190 M-039WV21 M-039WV32	A-A350520 K-94786700 M-0399600 N-8710550000		A-R60140 G-0810550000 M-03996N0				
NM-Motorservice Article no./ Artikelnummer/ Modelo número/ статья номер	NM-Motorservice Article no.:	NM-Motorservice Article no.:	NM-Motorservice Article no.:	NM-Motorservice Article no.:	NM-Motorservice Article no.:	NM-Motorservice Article no.:			
	LBS 34800 PA LBS 34800 SA	LB 34800 P LB 34800 S	KBS 34800 A	KB 34800 A	KR 34800	PB 34800			

ENGINE TYPE Motortyp/ tipo de motor/ тип двигателя	LINER KIT Liner Kit/ camisas de los cilindros/ Лайнер комплект	CYL. LINER Zylinderlaufbuchse/ camisas de los cilindros/ втулка цилиндра		PISTON + RINGS Kolben + Ringe/ Pistón + Anillos/ поршень и кольца		PISTON SET Kolben Set/ Pistón Set/ поршневой	RINGS SET Ring Set/ Anillos Set/ кольца		PIN Pin/ Perno/ Пин		
RHZ GRAND VITARA • VITARA 2.0 HDI also for PEUGEOT 1,997 cc 4 cyl 85.0 mm Bore Ø			No flange	Piston		Alfin skirt MOS2 treated	Rings		Ø : Length:	28.0 70.0	
		Length: Outside Ø: Flange Ø: Flange depth:	155.0 89.06 91.0 4.5	155.0 89.06	Length: Comp. height:		80.7 46.7 -6.0 -18.3	Top: 2nd: oil:			3.5 2.0 3.0
		Reference no.:		Reference no.:	Reference no.:	Reference no.:	Reference no.:		Reference no.:		
				A-A350566 K-99879601 M-0399900 N-8711470000			A-R60410 G-0811470000 K-80004594000 M-03999N0				
NM-Motorservice Article no./ Artikelnummer/ Modelo нúmero/ статья номер	NM-Motorservice Article no.:	NM-Motorservice Article no.:		NM-Motorservice Article no.:	NM-Motorservice Article no.:	NM-Motorservice Article no.:	NM-Motorservice Article no.:	NM-Motorservice Article no.:		NM-Motorservice Article no.:	
	LBS 34850 PA LBS 34850 SA	LB 34850 P LB 34850 S		KBS 34850 A	KB 34850 A	KB 34850 A	KR 34850	PB 34850			

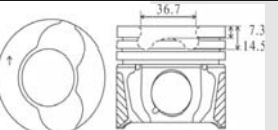

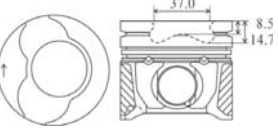

ENGINE TYPE Motortyp/ tipo de motor/ тип двигателя	LINER KIT Liner Kit/ camisas de los cilindros/ Лайнер комплект	CYL. LINER Zylinderlaufbuchse/ camisas de los cilindros/ втулка цилиндра		PISTON + RINGS Kolben + Ringe/ Pistón + Anillos/ поршень и кольца	PISTON SET Kolben Set/ Pistón Set/ поршневой	RINGS SET Ring Set/ Anillos Set/ кольца	PIN Pin/ Perno/ Пин	
1ND-TV YARIS ECHO VERSO (NCP21 NLP10) 2004- 1,364 cc 4 cyl 73.0 mm Bore Ø			Flanged	No flange	Piston Length: 64.1 Comp. height: 41.7 -7.2 -14.5	Alfin and with oil gallery skirt MOS2 treated	Rings Top: 1.5 2nd: 1.5 oil: 3.0	Ø: 27.0 Length: 59.0
		Length: 64.1 Outside Ø: Flange Ø: Flange depth:						
					Reference no.:	Reference no.:	Reference no.:	Reference no.:
NM-Motorservice Article no./ Artikelnummer/ Modelo número/ статья номер	NM-Motorservice Article no.:	NM-Motorservice Article no.:	NM-Motorservice Article no.:	NM-Motorservice Article no.:	NM-Motorservice Article no.:	NM-Motorservice Article no.:	NM-Motorservice Article no.:	
	LBS 34900 PB LBS 34900 SB	LB 34900 P LB 34900 S	KBS 34900 B	KB 34900 B	KR 34900	PB 34900		



ENGINE TYPE Motortyp/ tipo de motor/ тип двигателя	LINER KIT Liner Kit/ camisas de los cilindros/ Лайнер комплект	CYL. LINER Zylinderlaufbuchse/ camisas de los cilindros/ втулка цилиндра		PISTON + RINGS Kolben + Ringe/ Pistón + Anillos/ поршень и кольца	PISTON SET Kolben Set/ Pistón Set/ поршневой	RINGS SET Ring Set/ Anillos Set/ кольца	PIN Pin/ Perno/ Пин	
1ND-TV COROLLA YARIS (NDE120 NLP90) 2004- 1,364 cc 4 cyl 73.0 mm Bore Ø			Flanged	No flange	Piston Length: 64.3 Comp. height: 41.9 -7.3 -14.5	Alfin and with oil gallery 2nd ring land anodized skirt MOS2 treated	Rings Top: 1.5 2nd: 1.5 oil: 3.0	Ø: 27.0 Length: 59.0
		Length: 64.3 Outside Ø: Flange Ø: Flange depth:						
				O-Ring:	Reference no.:	Reference no.:	Reference no.:	
NM-Motorservice Article no./ Artikelnummer/ Modelo número/ статья номер	NM-Motorservice Article no.:	NM-Motorservice Article no.:	NM-Motorservice Article no.:	NM-Motorservice Article no.:	NM-Motorservice Article no.:	NM-Motorservice Article no.:	NM-Motorservice Article no.:	
	LBS 34950 PB LBS 34950 SB	LB 34950 P LB 34950 S	KBS 34950 B	KB 34950 B	KR 34950	PB 34950		



ENGINE TYPE Motortyp/ tipo de motor/ тип двигателя	LINER KIT Liner Kit/ camisas de los cilindros/ Лайнер комплект	CYL. LINER Zylinderlaufbuchse/ camisas de los cilindros/ втулка цилиндра		PISTON + RINGS Kolben + Ringe/ Pistón + Anillos/ поршень и кольца	PISTON SET Kolben Set/ Pistón Set/ поршневой	RINGS SET Ring Set/ Anillos Set/ кольца	PIN Pin/ Perno/ Пин	
2WZ-TV AYGO 1.4 TCI (WNB10) 2005- 1,398 cc 4 cyl 73.7 mm Bore Ø			Flanged	No flange	Piston Length: 65.44 Comp. height: 42.94 -8.5 -14.7	Alfin skirt MOS2 treated	Rings Top: 2.5 2nd: 1.95 oil: 2.5	Ø: 25.0 Length: 60.0
		Length: 65.44 Outside Ø: Flange Ø: Flange depth:	137.0 76.78 78.7 4.0	137.0 76.78				
				SU001-00537	Reference no.:	Reference no.:	Reference no.:	
NM-Motorservice Article no./ Artikelnummer/ Modelo número/ статья номер	NM-Motorservice Article no.:	NM-Motorservice Article no.:	NM-Motorservice Article no.:	NM-Motorservice Article no.:	NM-Motorservice Article no.:	NM-Motorservice Article no.:	NM-Motorservice Article no.:	
	LBS 35500 PA LBS 35500 SA	LB 35500 P LB 35500 S	KBS 35500 A	KB 35500 A	KR 35500	PB 35500		

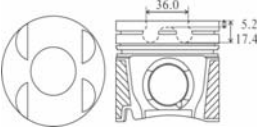

ENGINE TYPE Motortyp/ tipo de motor/ тип двигателя	LINER KIT Liner Kit/ camisas de los cilindros/ Лайнер комплект	CYL. LINER Zylinderlaufbuchse/ camisas de los cilindros/ втулка цилиндра			PISTON + RINGS Kolben + Ringe/ Pistón + Anillos/ поршень и кольца		PISTON SET Kolben Set/ Pistón Set/ поршневой	RINGS SET Ring Set/ Anillos Set/ кольца		PIN Pin/ Perno/ Пин
1N STARLET (NP70/80) 1986-1996 1,453 cc 4 cyl 74.0 mm Bore Ø			Flanged	No flange	Piston			Rings		Ø : 23.5 Length: 58.0
		Length: 136.0 Outside Ø: 78.0 Flange Ø: 82.0 Flange depth: 2.5	133.0 78.0	Length: 67.5 Comp. height: 38.5 -1.0 -2.0				Top: 1.5 2nd: 1.5 oil: 3.0		
		Reference no.:			Reference no.:		Reference no.:	Reference no.:		Reference no.:
							13101-55020 13103-55020	13011-55010 13011-55011 13013-55010		90999-73109
NM-Motorservice Article no./ Artikelnummer/ Modelo número/ статья номер	NM-Motorservice Article no.:	NM-Motorservice Article no.:			NM-Motorservice Article no.:		NM-Motorservice Article no.:	NM-Motorservice Article no.:		NM-Motorservice Article no.:
	LBS 35050 P LBS 35050 S	LB 35050 P LB 35050 S			KBS 35050		KB 35050	KR 35050		PB 35050

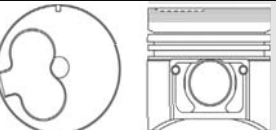

ENGINE TYPE Motortyp/ tipo de motor/ тип двигателя	LINER KIT Liner Kit/ camisas de los cilindros/ Лайнер комплект	CYL. LINER Zylinderlaufbuchse/ camisas de los cilindros/ втулка цилиндра			PISTON + RINGS Kolben + Ringe/ Pistón + Anillos/ поршень и кольца		PISTON SET Kolben Set/ Pistón Set/ поршневой	RINGS SET Ring Set/ Anillos Set/ кольца		PIN Pin/ Perno/ Пин
1WZ COROLLA (WZE110) 1999-2001 1,868 cc 4 cyl 82.2 mm Bore Ø			Flanged	No flange	Piston			Rings		Ø : 25.0 Length: 66.0
		Length: 154.0 Outside Ø: 86.0 Flange Ø: 88.0 Flange depth: 4.0	154.0 86.0	Length: 77.7 Comp. height: 46.8 -1.2	STD	O/S		77.45 46.5 -1.2	Top: 2.0 2nd: 2.0 oil: 3.0	
		Reference no.:			Reference no.:		Reference no.:	Reference no.:		Reference no.:
					SU001-00080			SU001-00081		SU001-00076
NM-Motorservice Article no./ Artikelnummer/ Modelo número/ статья номер	NM-Motorservice Article no.:	NM-Motorservice Article no.:			NM-Motorservice Article no.:		NM-Motorservice Article no.:	NM-Motorservice Article no.:		NM-Motorservice Article no.:
	LBS 35100 P LBS 35100 S	LB 35100 P LB 35100 S			KBS 35100		KB 35100	KR 35100		PB 35100

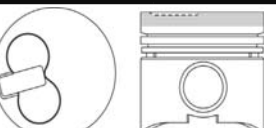

ENGINE TYPE Motortyp/ tipo de motor/ тип двигателя	LINER KIT Liner Kit/ camisas de los cilindros/ Лайнер комплект	CYL. LINER Zylinderlaufbuchse/ camisas de los cilindros/ втулка цилиндра			PISTON + RINGS Kolben + Ringe/ Pistón + Anillos/ поршень и кольца		PISTON SET Kolben Set/ Pistón Set/ поршневой	RINGS SET Ring Set/ Anillos Set/ кольца		PIN Pin/ Perno/ Пин
1CD-FTV AVENSIS COROLLA (CDT250 CUR10) 2003-2006 1,995 cc 4 cyl 82.2 mm Bore Ø			Flanged	No flange	Piston		Alfin and with oil gallery skirt MOS2 treated	Rings		Ø : 31.0 Length: 68.0
		Length: 151.0 Outside Ø: 86.2 Flange Ø: 88.2 Flange depth: 5.0	151.0 86.2	Length: 74.8 Comp. height: 47.8 -4.5 -15.5				Top: 2.0 2nd: 1.5 oil: 3.0		
		Reference no.:			Reference no.:		Reference no.:	Reference no.:		Reference no.:
							13101-27080 13101-OG010	13011-27030 13011-27040		
NM-Motorservice Article no./ Artikelnummer/ Modelo número/ статья номер	NM-Motorservice Article no.:	NM-Motorservice Article no.:			NM-Motorservice Article no.:		NM-Motorservice Article no.:	NM-Motorservice Article no.:		NM-Motorservice Article no.:
	LBS 91000 PB LBS 91000 SB	LB 91000 P LB 91000 S			KBS 91000 B		KB 91000 B	KR 91000		PB 91000



ENGINE TYPE Motortyp/ tipo de motor/ тип двигателя	LINER KIT Liner Kit/ camisas de los cilindros/ Лайнер комплект	CYL. LINER Zylinderlaufbuchse/ camisas de los cilindros/ втулка цилиндра		PISTON + RINGS Kolben + Ringe/ Pistón + Anillos/ поршень и кольца		PISTON SET Kolben Set/ Pistón Set/ поршневой	RINGS SET Ring Set/ Anillos Set/ кольца		PIN Pin/ Perno/ Пин	
1CD-FTV AVENSIS PREVIA RAV 4 (ACR30 CDT220 CLA2#) 1999-2007 1,995 cc 4 cyl 82.2 mm Bore Ø			Flanged	No flange	Piston		Alfin and with oil gallery skirt MOS2 treated		Rings	
		Length: 151.0 Outside Ø: 86.2 Flange Ø: 88.2 Flange depth: 5.0	151.0 86.2	151.0 86.2	Length: 74.8 Comp. height: 47.8 -5.2 -17.4	Top: 2.0 2nd: 1.5 oil: 3.0			Ø: 31.0 Length: 68.0	
		Reference no.:		Reference no.:		Reference no.:	Reference no.:	Reference no.:		
						13101-27050 13101-27051	13011-27030 13011-27040			
NM-Motorservice Article no./ Artikelnummer/ Modelo número/ статья номер	NM-Motorservice Article no.:	NM-Motorservice Article no.:		NM-Motorservice Article no.:		NM-Motorservice Article no.:	NM-Motorservice Article no.:	NM-Motorservice Article no.:		
	LBS 12000 PB LBS 12000 SB	LB 12000 P LB 12000 S		KBS 12000 B		KB 12000 B	KR 12000	PB 12000		

ENGINE TYPE Motortyp/ tipo de motor/ тип двигателя	LINER KIT Liner Kit/ camisas de los cilindros/ Лайнер комплект	CYL. LINER Zylinderlaufbuchse/ camisas de los cilindros/ втулка цилиндра		PISTON + RINGS Kolben + Ringe/ Pistón + Anillos/ поршень и кольца		PISTON SET Kolben Set/ Pistón Set/ поршневой	RINGS SET Ring Set/ Anillos Set/ кольца		PIN Pin/ Perno/ Пин	
1C CARINA LITEACE (CA60 CM20) 1982-1985 1,839 cc 4 cyl 83.0 mm Bore Ø			Flanged	No flange	Piston		Top: 2.0 2nd: 2.0 oil: 4.0		Rings	
		Length: 152.0 Outside Ø: 86.0 Flange Ø: 88.0 Flange depth: 5.0	152.0 86.0	144.0 87.0	Length: 77.0 Comp. height: 47.0 -1.0	Ø: 27.0 Length: 68.0				
		Reference no.:		Reference no.:		Reference no.:	Reference no.:	Reference no.:		
		11461-64011				13101-64010 13101-64020 13103-64010	13011-64010 13011-64020 13011-64040 13011-64070 13011-64080 13013-64000 13013-64020 13013-64070	90999-73091 90999-73101		
NM-Motorservice Article no./ Artikelnummer/ Modelo número/ статья номер	NM-Motorservice Article no.:	NM-Motorservice Article no.:		NM-Motorservice Article no.:		NM-Motorservice Article no.:	NM-Motorservice Article no.:	NM-Motorservice Article no.:		
	LBS 35250 P LBS 35250 S	LB 35250 P LB 35250 S		KBS 35250		KB 35250	KR 35250	PB 35250		

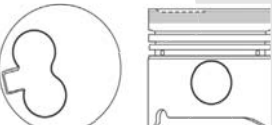
ENGINE TYPE Motortyp/ tipo de motor/ тип двигателя	LINER KIT Liner Kit/ camisas de los cilindros/ Лайнер комплект	CYL. LINER Zylinderlaufbuchse/ camisas de los cilindros/ втулка цилиндра		PISTON + RINGS Kolben + Ringe/ Pistón + Anillos/ поршень и кольца		PISTON SET Kolben Set/ Pistón Set/ поршневой	RINGS SET Ring Set/ Anillos Set/ кольца		PIN Pin/ Perno/ Пин	
1C LITEACE VAN WAGON (CM35) 1985-1988 1,839 cc 4 cyl 83.0 mm Bore Ø			Flanged	No flange	Piston		Top: 2.0 2nd: 2.0 oil: 3.0		Rings	
		Length: 152.0 Outside Ø: 86.0 Flange Ø: 88.0 Flange depth: 5.0	152.0 86.0	144.0 87.0	Length: 77.0 Comp. height: 47.0 -1.2	Ø: 27.0 Length: 58.0				
		Reference no.:		Reference no.:		Reference no.:	Reference no.:	Reference no.:		
		11461-64011				13101-64060 13103-64060	13011-64130 13011-64220 13013-64130	90999-73102 90999-73138		
NM-Motorservice Article no./ Artikelnummer/ Modelo número/ статья номер	NM-Motorservice Article no.:	NM-Motorservice Article no.:		NM-Motorservice Article no.:		NM-Motorservice Article no.:	NM-Motorservice Article no.:	NM-Motorservice Article no.:		
	LBS 35300 P LBS 35300 S	LB 35300 P LB 35300 S		KBS 35300		KB 35300	KR 35300	PB 35300		

ENGINE TYPE Motortyp/ tipo de motor/ тип двигателя	LINER KIT Liner Kit/ camisas de los cilindros/ Лайнер комплект	CYL. LINER Zylinderlaufbuchse/ camisas de los cilindros/ втулка цилиндра			PISTON + RINGS Kolben + Ringe/ Pistón + Anillos/ поршень и кольца		PISTON SET Kolben Set/ Pistón Set/ поршневой	RINGS SET Ring Set/ Anillos Set/ кольца		PIN Pin/ Perno/ Пин
1C 1,839 cc 4 cyl 83.0 mm Bore Ø			Flanged	No flange	Piston			Rings		Ø : 27.0 Length: 58.0
		Length: 152.0 Outside Ø: 86.0 Flange Ø: 88.0 Flange depth: 5.0		144.0 87.0	Length: 77.0 Comp. height: 47.0 -0.8 -1.0	Top: 2.0 2nd: 2.0 oil: 3.0				
		Reference no.:			Reference no.:	Reference no.:	Reference no.:	Reference no.:		Reference no.:
		11461-64011				13101-64050 13101-64100	13011-64130 13011-64220 13013-64130	90999-73102 90999-73138		
NM-Motorservice Article no./ Artikelnummer/ Modelo número/ статья номер	NM-Motorservice Article no.:	NM-Motorservice Article no.:			NM-Motorservice Article no.:	NM-Motorservice Article no.:	NM-Motorservice Article no.:	NM-Motorservice Article no.:		NM-Motorservice Article no.:
	LBS 35350 P LBS 35350 S	LB 35350 P LB 35350 S			KBS 35350	KB 35350	KR 35350	PB 35350		

ENGINE TYPE Motortyp/ tipo de motor/ тип двигателя	LINER KIT Liner Kit/ camisas de los cilindros/ Лайнер комплект	CYL. LINER Zylinderlaufbuchse/ camisas de los cilindros/ втулка цилиндра			PISTON + RINGS Kolben + Ringe/ Pistón + Anillos/ поршень и кольца		PISTON SET Kolben Set/ Pistón Set/ поршневой	RINGS SET Ring Set/ Anillos Set/ кольца		PIN Pin/ Perno/ Пин
1C-TL CAMRY (CV10) 1983-1985 1,839 cc 4 cyl 83.0 mm Bore Ø			Flanged	No flange	Piston			Rings		Ø : 27.0 Length: 68.0
		Length: 152.0 Outside Ø: 86.0 Flange Ø: 88.0 Flange depth: 5.0		144.0 87.0	Length: 77.0 Comp. height: 47.0 -1.1	Top: 2.0 2nd: 2.0 oil: 4.0				
		Reference no.:			Reference no.:	Reference no.:	Reference no.:	Reference no.:		Reference no.:
		11461-64010 11461-64011				13101-64040 13103-64040	13011-64010 13011-64020 13011-64040 13011-64070 13011-64080 13013-64000 13013-64020 13013-64070	90999-73091 90999-73101		
NM-Motorservice Article no./ Artikelnummer/ Modelo número/ статья номер	NM-Motorservice Article no.:	NM-Motorservice Article no.:			NM-Motorservice Article no.:	NM-Motorservice Article no.:	NM-Motorservice Article no.:	NM-Motorservice Article no.:		NM-Motorservice Article no.:
	LBS 35400 P LBS 35400 S	LB 35400 P LB 35400 S			KBS 35400	KB 35400	KR 35400	PB 35400		

ENGINE TYPE Motortyp/ tipo de motor/ тип двигателя	LINER KIT Liner Kit/ camisas de los cilindros/ Лайнер комплект	CYL. LINER Zylinderlaufbuchse/ camisas de los cilindros/ втулка цилиндра			PISTON + RINGS Kolben + Ringe/ Pistón + Anillos/ поршень и кольца		PISTON SET Kolben Set/ Pistón Set/ поршневой	RINGS SET Ring Set/ Anillos Set/ кольца		PIN Pin/ Perno/ Пин
1C New 1,839 cc 4 cyl 83.0 mm Bore Ø			Flanged	No flange	Piston			Rings		Ø : 27.0 Length: 58.0
		Length: 152.0 Outside Ø: 86.0 Flange Ø: 88.0 Flange depth: 5.0		144.0 87.0	Length: 76.8 Comp. height: 47.0 -1.0 -1.3	Top: 2.0 2nd: 2.0 oil: 3.0				
		Reference no.:			Reference no.:	Reference no.:	Reference no.:	Reference no.:		Reference no.:
		11461-64011				13101-64130	13011-64130 13011-64220 13013-64130	90999-73102 90999-73138		
NM-Motorservice Article no./ Artikelnummer/ Modelo número/ статья номер	NM-Motorservice Article no.:	NM-Motorservice Article no.:			NM-Motorservice Article no.:	NM-Motorservice Article no.:	NM-Motorservice Article no.:	NM-Motorservice Article no.:		NM-Motorservice Article no.:
	LBS 35450 P LBS 35450 S	LB 35450 P LB 35450 S			KBS 35450	KB 35450	KR 35450	PB 35450		

ENGINE TYPE Motortyp/ tipo de motor/ тип двигателя	LINER KIT Liner Kit/ camisas de los cilindros/ Лайнер комплект	CYL. LINER Zylinderlaufbuchse/ camisas de los cilindros/ втулка цилиндра		Piston + Rings Kolben + Ringe/ Pistón + Anillos/ поршень и кольца	Piston Set Kolben Set/ Pistón Set/ поршневой	Rings Set Ring Set/ Anillos Set/ кольца	PIN Pin/ Perno/ Пин	
2C MODEL-F (CR21) 1983-1985 1,974 cc 4 cyl 86.0 mm Bore Ø			Flanged	No flange	Piston Length: 77.0 Comp. height: 47.0 -1.3	Rings Top: 2.0 2nd: 2.0 oil: 4.0		Ø: 27.0 Length: 68.0
		Length: 151.0 Outside Ø: 89.2 Flange Ø: 91.0 Flange depth: 4.8	150.0	90.0		Reference no.:	Reference no.:	Reference no.:
		Reference no.: 11461-64090			Reference no.: 13101-64030 13103-64030	Reference no.: 13011-64060 13011-64110 13011-64150 13013-64060 13013-64110 13013-64150	Reference no.: 90999-73091 90999-73101	
NM-Motorservice Article no./ Artikelnummer/ Modelo número/ статья номер	NM-Motorservice Article no.:	NM-Motorservice Article no.:	NM-Motorservice Article no.:	NM-Motorservice Article no.:	NM-Motorservice Article no.:	NM-Motorservice Article no.:	NM-Motorservice Article no.:	
	LBS 35000 P LBS 35000 S	LB 35000 P LB 35000 S	KBS 35000	KB 35000	KR 35000	PB 35000		

ENGINE TYPE Motortyp/ tipo de motor/ тип двигателя	LINER KIT Liner Kit/ camisas de los cilindros/ Лайнер комплект	CYL. LINER Zylinderlaufbuchse/ camisas de los cilindros/ втулка цилиндра		Piston + Rings Kolben + Ringe/ Pistón + Anillos/ поршень и кольца	Piston Set Kolben Set/ Pistón Set/ поршневой	Rings Set Ring Set/ Anillos Set/ кольца	PIN Pin/ Perno/ Пин	
2C New LITEACE CARINA 2 VAN WAGON (CM3# CR2# CT170/190) 1987-1996 1,974 cc 4 cyl 86.0 mm Bore Ø			Flanged	No flange	Piston Length: 77.0 Comp. height: 47.0 -1.4	Rings Top: 2.0 2nd: 2.0 oil: 3.0		Ø: 27.0 Length: 58.0
		Length: 151.0 Outside Ø: 89.2 Flange Ø: 91.0 Flange depth: 4.8	150.0	90.0		Reference no.:	Reference no.:	Reference no.:
		Reference no.:						
NM-Motorservice Article no./ Artikelnummer/ Modelo número/ статья номер	NM-Motorservice Article no.:	NM-Motorservice Article no.:	NM-Motorservice Article no.:	NM-Motorservice Article no.:	NM-Motorservice Article no.:	NM-Motorservice Article no.:	NM-Motorservice Article no.:	
	LBS 35550 P LBS 35550 S	LB 35550 P LB 35550 S	KBS 35550	KB 35550	KR 35550	PB 35550		

ENGINE TYPE Motortyp/ tipo de motor/ тип двигателя	LINER KIT Liner Kit/ camisas de los cilindros/ Лайнер комплект	CYL. LINER Zylinderlaufbuchse/ camisas de los cilindros/ втулка цилиндра		Piston + Rings Kolben + Ringe/ Pistón + Anillos/ поршень и кольца	Piston Set Kolben Set/ Pistón Set/ поршневой	Rings Set Ring Set/ Anillos Set/ кольца	PIN Pin/ Perno/ Пин	
2CT 2CT-L CAMRY (CV11/20) 1985-1987 1,974 cc 4 cyl 86.0 mm Bore Ø			Flanged	No flange	Piston Length: 77.0 Comp. height: 47.0 -1.3	Rings Top: 2.0 2nd: 2.0 oil: 4.0		Ø: 27.0 Length: 61.0
		Length: 151.0 Outside Ø: 89.2 Flange Ø: 91.0 Flange depth: 4.8	150.0	90.0		Reference no.:	Reference no.:	Reference no.:
		Reference no.: 11461-64090			Reference no.: 13101-64070 13103-64070	Reference no.: 13011-64060 13011-64110 13011-64150 13013-64060 13013-64110 13013-64150	Reference no.: 90999-73101 90999-73102 90999-73138	
NM-Motorservice Article no./ Artikelnummer/ Modelo número/ статья номер	NM-Motorservice Article no.:	NM-Motorservice Article no.:	NM-Motorservice Article no.:	NM-Motorservice Article no.:	NM-Motorservice Article no.:	NM-Motorservice Article no.:	NM-Motorservice Article no.:	
	LBS 35600 P LBS 35600 S LBS 35600 PA LBS 35600 SA	LB 35600 P LB 35600 S	KBS 35600 KBS 35600 A	KB 35600 KB 35600 A	KR 35600	PB 35600		

ENGINE TYPE Motortyp/ tipo de motor/ тип двигателя	LINER KIT Liner Kit/ camisas de los cilindros/ Лайнер комплект	CYL. LINER Zylinderlaufbuchse/ camisas de los cilindros/ втулка цилиндра			PISTON + RINGS Kolben + Ringe/ Pistón + Anillos/ поршень и кольца		PISTON SET Kolben Set/ Pistón Set/ поршневой	RINGS SET Ring Set/ Anillos Set/ кольца		PIN Pin/ Perno/ Пин	
2C MODEL-F (CR21) 1985-1987 1,974 cc 4 cyl 86.0 mm Bore Ø			Flanged	No flange	Piston			Rings		Ø : 27.0 Length: 58.0	
		Length:	151.0	150.0	Length:	77.0		Top:	1.75		2nd: oil:
		Outside Ø:	89.2	90.0	Comp. height:	47.0		oil:	2.0		
Flange Ø:	91.0			-0.8		3.0					
		Reference no.:			Reference no.:		Reference no.:		Reference no.:		
		11461-64090					13101-64080 13103-64080		13011-64170 13013-64170		
NM-Motorservice Article no./ Artikelnummer/ Modelo número/ статья номер	NM-Motorservice Article no.:	NM-Motorservice Article no.:			NM-Motorservice Article no.:		NM-Motorservice Article no.:		NM-Motorservice Article no.:		
	LBS 35650 P LBS 35650 S	LB 35650 P LB 35650 S			KBS 35650		KB 35650		KR 35650		



ENGINE TYPE Motortyp/ tipo de motor/ тип двигателя	LINER KIT Liner Kit/ camisas de los cilindros/ Лайнер комплект	CYL. LINER Zylinderlaufbuchse/ camisas de los cilindros/ втулка цилиндра			PISTON + RINGS Kolben + Ringe/ Pistón + Anillos/ поршень и кольца		PISTON SET Kolben Set/ Pistón Set/ поршневой	RINGS SET Ring Set/ Anillos Set/ кольца		PIN Pin/ Perno/ Пин	
2C MODEL-F (CR21) 1987-1988 1,974 cc 4 cyl 86.0 mm Bore Ø			Flanged	No flange	Piston			Rings		Ø : 27.0 Length: 58.0	
		Length:	151.0	150.0	Length:	77.0		Top:	1.75		2nd: oil:
		Outside Ø:	89.2	90.0	Comp. height:	47.0		oil:	2.0		
Flange Ø:	91.0			-2.2		3.0					
		Reference no.:			Reference no.:		Reference no.:		Reference no.:		
		11461-64090					13101-64090 13103-64090		13011-64170 13013-64170		
NM-Motorservice Article no./ Artikelnummer/ Modelo número/ статья номер	NM-Motorservice Article no.:	NM-Motorservice Article no.:			NM-Motorservice Article no.:		NM-Motorservice Article no.:		NM-Motorservice Article no.:		
	LBS 35700 P LBS 35700 S	LB 35700 P LB 35700 S			KBS 35700		KB 35700		KR 35700		



ENGINE TYPE Motortyp/ tipo de motor/ тип двигателя	LINER KIT Liner Kit/ camisas de los cilindros/ Лайнер комплект	CYL. LINER Zylinderlaufbuchse/ camisas de los cilindros/ втулка цилиндра			PISTON + RINGS Kolben + Ringe/ Pistón + Anillos/ поршень и кольца		PISTON SET Kolben Set/ Pistón Set/ поршневой	RINGS SET Ring Set/ Anillos Set/ кольца		PIN Pin/ Perno/ Пин	
2CT AVENSIS (CT220) 1998-2000 1,974 cc 4 cyl 86.0 mm Bore Ø			Flanged	No flange	Piston		Alfin and with oil gallery head anodized	Rings		Ø : 27.0 Length: 66.0	
		Length:	151.0	150.0	Length:	77.0		Top:	2.0		2nd: oil:
		Outside Ø:	89.2	90.0	Comp. height:	47.0		oil:	2.0		
Flange Ø:	91.0			-1.4		3.0					
		Reference no.:			Reference no.:		Reference no.:		Reference no.:		
		11461-64090					13101-64181 13103-64181		13011-64190/1 13011-64202 13011-64210 13011-64212/3 13013-64190/1 13013-64212/3		
NM-Motorservice Article no./ Artikelnummer/ Modelo número/ статья номер	NM-Motorservice Article no.:	NM-Motorservice Article no.:			NM-Motorservice Article no.:		NM-Motorservice Article no.:		NM-Motorservice Article no.:		
	LBS 35750 PB LBS 35750 SB	LB 35750 P LB 35750 S			KBS 35750 B		KB 35750 B		KR 35750		

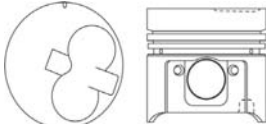

ENGINE TYPE Motortyp/ tipo de motor/ тип двигателя	LINER KIT Liner Kit/ camisas de los cilindros/ Лайнер комплект	CYL. LINER Zylinderlaufbuchse/ camisas de los cilindros/ втулка цилиндра		PISTON + RINGS Kolben + Ringe/ Pistón + Anillos/ поршень и кольца	PISTON SET Kolben Set/ Pistón Set/ поршневой	RINGS SET Ring Set/ Anillos Set/ кольца	PIN Pin/ Perno/ Пин		
3C-TE PICNIC (СХМ10) 1997-2001 2,184 cc 4 cyl 86.0 mm Bore Ø			No flange	Piston		with oil gallery		Rings	
		Length: Outside Ø: Flange Ø: Flange depth:	151.0 89.2 91.0 4.8	150.0 90.0	Length: Comp. height:	72.5 42.5 -1.9 -2.9	Top: 2nd: oil:	2.0 2.0 3.0	Ø: Length:
		Reference no.:		Reference no.:		Reference no.:		Reference no.:	
		11461-64090				13101-64151 13101-64210 13103-64151 13103-64210		13011-64190/1 13011-64202 13011-64210 13011-64212/3 13013-64190/1 13013-64212/3	
NM-Motorservice Article no./ Artikelnummer/ Modelo número/ статья номер		NM-Motorservice Article no.:		NM-Motorservice Article no.:		NM-Motorservice Article no.:		NM-Motorservice Article no.:	
		LBS 35800 PG LBS 35800 SG		LB 35800 P LB 35800 S		KBS 35800 G		KB 35800 G	
						KR 35800		PB 35800	

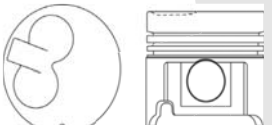

ENGINE TYPE Motortyp/ tipo de motor/ тип двигателя	LINER KIT Liner Kit/ camisas de los cilindros/ Лайнер комплект	CYL. LINER Zylinderlaufbuchse/ camisas de los cilindros/ втулка цилиндра		PISTON + RINGS Kolben + Ringe/ Pistón + Anillos/ поршень и кольца	PISTON SET Kolben Set/ Pistón Set/ поршневой	RINGS SET Ring Set/ Anillos Set/ кольца	PIN Pin/ Perno/ Пин		
3CT 2,184 cc 4 cyl 86.0 mm Bore Ø			No flange	Piston		Alfin and with oil gallery		Rings	
		Length: Outside Ø: Flange Ø: Flange depth:	151.0 89.2 91.0 4.8	150.0 90.0	Length: Comp. height:	72.5 42.5 -2.1 -3.0	Top: 2nd: oil:	2.0 2.0 3.0	Ø: Length:
		Reference no.:		Reference no.:		Reference no.:		Reference no.:	
		11461-64090				13101-64150		13011-64190/1 13011-64202 13011-64210 13011-64212/3 13013-64190/1 13013-64212/3	
NM-Motorservice Article no./ Artikelnummer/ Modelo número/ статья номер		NM-Motorservice Article no.:		NM-Motorservice Article no.:		NM-Motorservice Article no.:		NM-Motorservice Article no.:	
		LBS 35850 PB LBS 35850 SB		LB 35850 P LB 35850 S		KBS 35850 B		KB 35850 B	
						KR 35850		PB 35850	

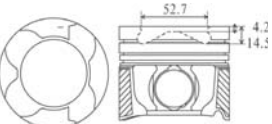

ENGINE TYPE Motortyp/ tipo de motor/ тип двигателя	LINER KIT Liner Kit/ camisas de los cilindros/ Лайнер комплект	CYL. LINER Zylinderlaufbuchse/ camisas de los cilindros/ втулка цилиндра		PISTON + RINGS Kolben + Ringe/ Pistón + Anillos/ поршень и кольца	PISTON SET Kolben Set/ Pistón Set/ поршневой	RINGS SET Ring Set/ Anillos Set/ кольца	PIN Pin/ Perno/ Пин		
2AD-FTV AVENSIS RAV 4 (ADT251 ALA30) 2005- 2,231 cc 4 cyl 86.0 mm Bore Ø			No flange	Piston		Alfin and with oil gallery skirt MOS2 treated		Rings	
		Length: Outside Ø: Flange Ø: Flange depth:	160.0 90.0 94.0 3.0	160.0 90.0	Length: Comp. height:	72.0 48.0 -4.3 -13.9	Top: 2nd: oil:	2.0 1.5 2.0	Ø: Length:
		Reference no.:		Reference no.:		Reference no.:		Reference no.:	
						13101-0R010 13101-0R012		13011-26070 13011-0R010 13011-0R030	
NM-Motorservice Article no./ Artikelnummer/ Modelo número/ статья номер		NM-Motorservice Article no.:		NM-Motorservice Article no.:		NM-Motorservice Article no.:		NM-Motorservice Article no.:	
		LBS 76000 PB LBS 76000 SB		LB 76000 P LB 76000 S		KBS 76000 B		KB 76000 B	
						KR 76000		PB 76000	

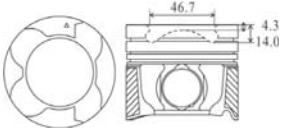

ENGINE TYPE Motortyp/ tipo de motor/ тип двигателя	LINER KIT Liner Kit/ camisas de los cilindros/ Лайнер комплект	CYL. LINER Zylinderlaufbuchse/ camisas de los cilindros/ втулка цилиндра		PISTON + RINGS Kolben + Ringe/ Pistón + Anillos/ поршень и кольца		PISTON SET Kolben Set/ Pistón Set/ поршневой	RINGS SET Ring Set/ Anillos Set/ кольца		PIN Pin/ Perno/ Пин		
1DZ 2,486 cc 4 cyl 86.0 mm Bore Ø			Flanged	No flange	Piston		Alfin head anodized		Rings Top: 2.0 2nd: 2.0 oil: 4.0	Ø : 27.0 Length: 68.0	
		Length: 180.0 Outside Ø: 90.0 Flange Ø: 93.0 Flange depth: 5.0	175.0 90.0	Length: 77.0 Comp. height: 47.0 -2.3	Reference no.:		Reference no.:				Reference no.:
		Reference no.:		Reference no.:		Reference no.:		Reference no.:		Reference no.:	
		11461-78200				13101-78201		13011-78201		90999-73950	
NM-Motorservice Article no./ Artikelnummer/ Modelo número/ статья номер	NM-Motorservice Article no.:	NM-Motorservice Article no.:		NM-Motorservice Article no.:		NM-Motorservice Article no.:		NM-Motorservice Article no.:		NM-Motorservice Article no.:	
	LBS 35950 PA LBS 35950 SA	LB 35950 P LB 35950 S		KBS 35950 A		KB 35950 A		KR 35950		PB 35950	

ENGINE TYPE Motortyp/ tipo de motor/ тип двигателя	LINER KIT Liner Kit/ camisas de los cilindros/ Лайнер комплект	CYL. LINER Zylinderlaufbuchse/ camisas de los cilindros/ втулка цилиндра		PISTON + RINGS Kolben + Ringe/ Pistón + Anillos/ поршень и кольца		PISTON SET Kolben Set/ Pistón Set/ поршневой	RINGS SET Ring Set/ Anillos Set/ кольца		PIN Pin/ Perno/ Пин		
1DZ New 2,486 cc 4 cyl 86.0 mm Bore Ø			Flanged	No flange	Piston		Head, top and 2nd ring lands anodized		Rings Top: 2.0 2nd: 2.0 oil: 3.0	Ø : 27.0 Length: 68.0	
		Length: 180.0 Outside Ø: 90.0 Flange Ø: 93.0 Flange depth: 5.0	175.0 90.0	Length: 76.3 Comp. height: 46.4 -1.7 -2.2	Reference no.:		Reference no.:				Reference no.:
		Reference no.:		Reference no.:		Reference no.:		Reference no.:		Reference no.:	
		11461-78020 11461-78200				13101-78202		13011-64190/1 13011-64202 13011-64210 13011-64212/3 13013-64190/1 13013-64212/3		90999-73950	
NM-Motorservice Article no./ Artikelnummer/ Modelo número/ статья номер	NM-Motorservice Article no.:	NM-Motorservice Article no.:		NM-Motorservice Article no.:		NM-Motorservice Article no.:		NM-Motorservice Article no.:		NM-Motorservice Article no.:	
	LBS 44900 PB LBS 44900 SB	LB 44900 P LB 44900 S		KBS 44900B		KB 44900 B		KR 44900		PB 44900	

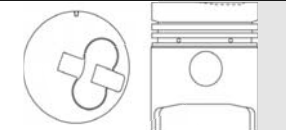
ENGINE TYPE Motortyp/ tipo de motor/ тип двигателя	LINER KIT Liner Kit/ camisas de los cilindros/ Лайнер комплект	CYL. LINER Zylinderlaufbuchse/ camisas de los cilindros/ втулка цилиндра		PISTON + RINGS Kolben + Ringe/ Pistón + Anillos/ поршень и кольца		PISTON SET Kolben Set/ Pistón Set/ поршневой	RINGS SET Ring Set/ Anillos Set/ кольца		PIN Pin/ Perno/ Пин		
2AD-FHV AVENSIS • IS220D • RAV 4 (ADT251 • ALA30 • ALE20) 2005- 2,231 cc 4 cyl 86.0 mm Bore Ø			Flanged	No flange	Piston		Alfin and with oil gallery skirt MOS2 treated		Rings Top: 2.0 2nd: 1.5 oil: 2.0	Ø : 29.0 Length: 69.0	
		Length: 160.0 Outside Ø: 90.0 Flange Ø: 94.0 Flange depth: 3.0	160.0 90.0	Length: 72.0 Comp. height: 48.0 -4.2 -14.5	Reference no.:		Reference no.:				Reference no.:
		Reference no.:		Reference no.:		Reference no.:		Reference no.:		Reference no.:	
						13101-0R020 13101-0R021 13101-0R022		13011-26070 13011-0R010 13011-0R030			
NM-Motorservice Article no./ Artikelnummer/ Modelo número/ статья номер	NM-Motorservice Article no.:	NM-Motorservice Article no.:		NM-Motorservice Article no.:		NM-Motorservice Article no.:		NM-Motorservice Article no.:		NM-Motorservice Article no.:	
	LBS 33500 PB LBS 33500 SB	LB 33500 P LB 33500 S		KBS 33500 CB		KB 33500 CB		KR 33500		PB 33500	

ENGINE TYPE Motortyp/ tipo de motor/ тип двигателя	LINER KIT Liner Kit/ camisas de los cilindros/ Лайнер комплект	CYL. LINER Zylinderlaufbuchse/ camisas de los cilindros/ втулка цилиндра	PISTON + RINGS Kolben + Ringe/ Pistón + Anillos/ поршень и кольца	PISTON SET Kolben Set/ Pistón Set/ поршневой	RINGS SET Ring Set/ Anillos Set/ кольца	PIN Pin/ Perno/ Пин																																					
1AD-FTV AVENSIS (ADT250) 2006- 1,998 cc 4 cyl 86.0 mm Bore Ø		<table border="1"> <tr> <td></td> <td>Flanged</td> <td>No flange</td> </tr> <tr> <td>Length:</td> <td>160.0</td> <td>160.0</td> </tr> <tr> <td>Outside Ø:</td> <td>90.0</td> <td>90.0</td> </tr> <tr> <td>Flange Ø:</td> <td>94.0</td> <td></td> </tr> <tr> <td>Flange depth:</td> <td>3.0</td> <td></td> </tr> </table>		Flanged	No flange	Length:	160.0	160.0	Outside Ø:	90.0	90.0	Flange Ø:	94.0		Flange depth:	3.0		<table border="1"> <tr> <td colspan="2">Piston</td> </tr> <tr> <td>Length:</td> <td>72.0</td> </tr> <tr> <td>Comp. height:</td> <td>48.0</td> </tr> <tr> <td></td> <td>-4.3</td> </tr> <tr> <td></td> <td>-14.0</td> </tr> </table>	Piston		Length:	72.0	Comp. height:	48.0		-4.3		-14.0	Alfin and with oil gallery skirt MOS2 treated	<table border="1"> <tr> <td colspan="2">Rings</td> </tr> <tr> <td>Top:</td> <td>2.0</td> </tr> <tr> <td>2nd:</td> <td>1.5</td> </tr> <tr> <td>oil:</td> <td>2.0</td> </tr> <tr> <td>Ø:</td> <td>29.0</td> </tr> <tr> <td>Length:</td> <td>69.0</td> </tr> </table>	Rings		Top:	2.0	2nd:	1.5	oil:	2.0	Ø:	29.0	Length:	69.0	
			Flanged	No flange																																							
Length:	160.0	160.0																																									
Outside Ø:	90.0	90.0																																									
Flange Ø:	94.0																																										
Flange depth:	3.0																																										
Piston																																											
Length:	72.0																																										
Comp. height:	48.0																																										
	-4.3																																										
	-14.0																																										
Rings																																											
Top:	2.0																																										
2nd:	1.5																																										
oil:	2.0																																										
Ø:	29.0																																										
Length:	69.0																																										
	Reference no.:	Reference no.:	Reference no.:	Reference no.:	Reference no.:																																						
				13101-0R030 13101-0R032	13011-26070 13011-0R010 13011-0R030																																						
NM-Motorservice Article no./ Artikelnummer/ Modelo número/ статья номер	NM-Motorservice Article no.:	NM-Motorservice Article no.:	NM-Motorservice Article no.:	NM-Motorservice Article no.:	NM-Motorservice Article no.:	NM-Motorservice Article no.:																																					
	LBS 34500 PB LBS 34500 SB	LB 34500 P LB 34500 S	KBS 34500 B	KB 34500 B	KR 34500	PB 34500																																					

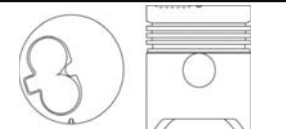

ENGINE TYPE Motortyp/ tipo de motor/ тип двигателя	LINER KIT Liner Kit/ camisas de los cilindros/ Лайнер комплект	CYL. LINER Zylinderlaufbuchse/ camisas de los cilindros/ втулка цилиндра	PISTON + RINGS Kolben + Ringe/ Pistón + Anillos/ поршень и кольца	PISTON SET Kolben Set/ Pistón Set/ поршневой	RINGS SET Ring Set/ Anillos Set/ кольца	PIN Pin/ Perno/ Пин																																						
2J 3 Rings (L/R) DYNA • TOYOACE (JU20 • JY16/30) 1975-1983 2,481 cc 4 cyl 88.0 mm Bore Ø		<table border="1"> <tr> <td></td> <td>Liner/ Sleeve</td> <td></td> </tr> <tr> <td>Length:</td> <td>183.5</td> <td></td> </tr> <tr> <td>Outside Ø:</td> <td>93.0</td> <td></td> </tr> <tr> <td>Flange Ø:</td> <td>98.0</td> <td></td> </tr> <tr> <td>Flange depth:</td> <td>2.5</td> <td></td> </tr> <tr> <td></td> <td>+1.0</td> <td></td> </tr> </table>		Liner/ Sleeve		Length:	183.5		Outside Ø:	93.0		Flange Ø:	98.0		Flange depth:	2.5			+1.0		<table border="1"> <tr> <td colspan="2">Piston</td> </tr> <tr> <td>Length:</td> <td>102.2</td> </tr> <tr> <td>Comp. height:</td> <td>52.2</td> </tr> <tr> <td></td> <td>-3.1</td> </tr> </table>	Piston		Length:	102.2	Comp. height:	52.2		-3.1		<table border="1"> <tr> <td colspan="2">Rings</td> </tr> <tr> <td>Top:</td> <td>2.5</td> </tr> <tr> <td>2nd:</td> <td>2.5</td> </tr> <tr> <td>oil:</td> <td>4.0</td> </tr> <tr> <td>Ø:</td> <td>27.0</td> </tr> <tr> <td>Length:</td> <td>74.0</td> </tr> </table>	Rings		Top:	2.5	2nd:	2.5	oil:	4.0	Ø:	27.0	Length:	74.0	
			Liner/ Sleeve																																									
Length:	183.5																																											
Outside Ø:	93.0																																											
Flange Ø:	98.0																																											
Flange depth:	2.5																																											
	+1.0																																											
Piston																																												
Length:	102.2																																											
Comp. height:	52.2																																											
	-3.1																																											
Rings																																												
Top:	2.5																																											
2nd:	2.5																																											
oil:	4.0																																											
Ø:	27.0																																											
Length:	74.0																																											
	Reference no.:	Reference no.:	Reference no.:	Reference no.:	Reference no.:																																							
		11461-47011 11461-48010 11461-48011		13081-48014/15 13085-48014/15 13101-48014/15 (L/R)	13011-48022 13011-48023 13011-48030 13015-48022 13015-48023	90999-70048 90999-73069 90999-73083																																						
NM-Motorservice Article no./ Artikelnummer/ Modelo número/ статья номер	NM-Motorservice Article no.:	NM-Motorservice Article no.:	NM-Motorservice Article no.:	NM-Motorservice Article no.:	NM-Motorservice Article no.:	NM-Motorservice Article no.:																																						
	LBS 36150 F LBS 36150 S	LB 36150 F LB 36150 S	KBS 36150	KB 36150	KR 36150	PB 36150																																						

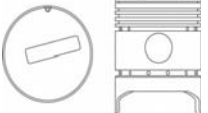

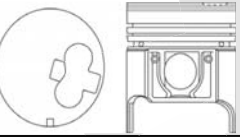
ENGINE TYPE Motortyp/ tipo de motor/ тип двигателя	LINER KIT Liner Kit/ camisas de los cilindros/ Лайнер комплект	CYL. LINER Zylinderlaufbuchse/ camisas de los cilindros/ втулка цилиндра	PISTON + RINGS Kolben + Ringe/ Pistón + Anillos/ поршень и кольца	PISTON SET Kolben Set/ Pistón Set/ поршневой	RINGS SET Ring Set/ Anillos Set/ кольца	PIN Pin/ Perno/ Пин																																								
2J 4 Rings (L/R) TOYOACE (JY16) 1972-1975 2,481 cc 4 cyl 88.0 mm Bore Ø		<table border="1"> <tr> <td></td> <td>Liner/ Sleeve</td> <td></td> </tr> <tr> <td>Length:</td> <td>183.5</td> <td></td> </tr> <tr> <td>Outside Ø:</td> <td>93.0</td> <td></td> </tr> <tr> <td>Flange Ø:</td> <td>98.0</td> <td></td> </tr> <tr> <td>Flange depth:</td> <td>2.5</td> <td></td> </tr> <tr> <td></td> <td>+1.0</td> <td></td> </tr> </table>		Liner/ Sleeve		Length:	183.5		Outside Ø:	93.0		Flange Ø:	98.0		Flange depth:	2.5			+1.0		<table border="1"> <tr> <td colspan="2">Piston</td> </tr> <tr> <td>Length:</td> <td>102.2</td> </tr> <tr> <td>Comp. height:</td> <td>52.2</td> </tr> <tr> <td></td> <td>-2.1</td> </tr> </table>	Piston		Length:	102.2	Comp. height:	52.2		-2.1		<table border="1"> <tr> <td colspan="2">Rings</td> </tr> <tr> <td>Top:</td> <td>2.5</td> </tr> <tr> <td>2nd:</td> <td>2.5</td> </tr> <tr> <td>3rd:</td> <td>2.5</td> </tr> <tr> <td>oil:</td> <td>4.0</td> </tr> <tr> <td>Ø:</td> <td>27.0</td> </tr> <tr> <td>Length:</td> <td>74.0</td> </tr> </table>	Rings		Top:	2.5	2nd:	2.5	3rd:	2.5	oil:	4.0	Ø:	27.0	Length:	74.0	
			Liner/ Sleeve																																											
Length:	183.5																																													
Outside Ø:	93.0																																													
Flange Ø:	98.0																																													
Flange depth:	2.5																																													
	+1.0																																													
Piston																																														
Length:	102.2																																													
Comp. height:	52.2																																													
	-2.1																																													
Rings																																														
Top:	2.5																																													
2nd:	2.5																																													
3rd:	2.5																																													
oil:	4.0																																													
Ø:	27.0																																													
Length:	74.0																																													
	Reference no.:	Reference no.:	Reference no.:	Reference no.:	Reference no.:																																									
		11461-47011 11461-48010 11461-48011		13081-48012 13081-48013 13085-48013 13101-48012 13101-48013 (L/R)	13011-48013 13011-48021 13015-48021	90999-70048 90999-73069 90999-73083																																								
NM-Motorservice Article no./ Artikelnummer/ Modelo número/ статья номер	NM-Motorservice Article no.:	NM-Motorservice Article no.:	NM-Motorservice Article no.:	NM-Motorservice Article no.:	NM-Motorservice Article no.:	NM-Motorservice Article no.:																																								
	LBS 36200 F LBS 36200 S	LB 36200 F LB 36200 S	KBS 36200	KB 36200	KR 36200	PB 36200																																								

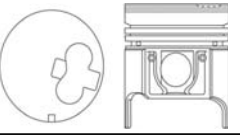

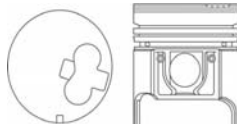
ENGINE TYPE Motortyp/ tipo de motor/ тип двигателя	LINER KIT Liner Kit/ camisas de los cilindros/ Лайнер комплект	CYL. LINER Zylinderlaufbuchse/ camisas de los cilindros/ втулка цилиндра	PISTON + RINGS Kolben + Ringe/ Pistón + Anillos/ поршень и кольца	PISTON SET Kolben Set/ Pistón Set/ поршневой	RINGS SET Ring Set/ Anillos Set/ кольца	PIN Pin/ Perno/ Пин																																									
J 5 Rings (L/R) 2J 5 Rings (L/R) 2,336 cc / 2,481 cc 4cyl 88.0 mm Bore Ø		<table border="1"> <tr> <td></td> <td>Liner/ Sleeve</td> <td></td> </tr> <tr> <td>Length:</td> <td>183.5</td> <td></td> </tr> <tr> <td>Outside Ø:</td> <td>93.0</td> <td></td> </tr> <tr> <td>Flange Ø:</td> <td>98.0</td> <td></td> </tr> <tr> <td>Flange depth:</td> <td>2.5 +1.0</td> <td></td> </tr> </table>		Liner/ Sleeve		Length:	183.5		Outside Ø:	93.0		Flange Ø:	98.0		Flange depth:	2.5 +1.0		<table border="1"> <tr> <td></td> <td>Piston</td> <td></td> </tr> <tr> <td>Length:</td> <td>114.2</td> <td></td> </tr> <tr> <td>Comp. height:</td> <td>52.2 -4.0</td> <td></td> </tr> </table>		Piston		Length:	114.2		Comp. height:	52.2 -4.0			<table border="1"> <tr> <td></td> <td>Rings</td> <td></td> </tr> <tr> <td>Top:</td> <td>2.5</td> <td rowspan="2">Ø : 27.0 Length: 74.0</td> </tr> <tr> <td>2nd:</td> <td>2.5</td> </tr> <tr> <td>3rd:</td> <td>2.5</td> <td></td> </tr> <tr> <td>1st oil:</td> <td>4.0</td> <td></td> </tr> <tr> <td>2nd oil:</td> <td>4.0</td> <td></td> </tr> </table>		Rings		Top:	2.5	Ø : 27.0 Length: 74.0	2nd:	2.5	3rd:	2.5		1st oil:	4.0		2nd oil:	4.0		
			Liner/ Sleeve																																												
		Length:	183.5																																												
Outside Ø:	93.0																																														
Flange Ø:	98.0																																														
Flange depth:	2.5 +1.0																																														
	Piston																																														
Length:	114.2																																														
Comp. height:	52.2 -4.0																																														
	Rings																																														
Top:	2.5	Ø : 27.0 Length: 74.0																																													
2nd:	2.5																																														
3rd:	2.5																																														
1st oil:	4.0																																														
2nd oil:	4.0																																														
		Reference no.:	Reference no.:	Reference no.:	Reference no.:	Reference no.:																																									
		11461-47011 11461-48010 11461-48011		13081-46011 13081-46012 13081-48010 (L/R)	13011-46021	90999-70048 90999-73069 90999-73083																																									
NM-Motorservice Article no./ Artikelnummer/ Modelo número/ статья номер	NM-Motorservice Article no.:	NM-Motorservice Article no.:	NM-Motorservice Article no.:	NM-Motorservice Article no.:	NM-Motorservice Article no.:	NM-Motorservice Article no.:																																									
	LBS 36250 F LBS 36250 S	LB 36250 F LB 36250 S	KBS 36250	KB 36250	KR 36250	PB 36250																																									



ENGINE TYPE Motortyp/ tipo de motor/ тип двигателя	LINER KIT Liner Kit/ camisas de los cilindros/ Лайнер комплект	CYL. LINER Zylinderlaufbuchse/ camisas de los cilindros/ втулка цилиндра	PISTON + RINGS Kolben + Ringe/ Pistón + Anillos/ поршень и кольца	PISTON SET Kolben Set/ Pistón Set/ поршневой	RINGS SET Ring Set/ Anillos Set/ кольца	PIN Pin/ Perno/ Пин																																			
L LN30 CROWN • HIACE • HILUX • TOYOACE (LH11/20/30 • LN3#/4# • LS110 • LY20/30) 1979-1981 2,188 cc 4 cyl 90.0 mm Bore Ø		<table border="1"> <tr> <td></td> <td>Liner/ Sleeve</td> <td></td> </tr> <tr> <td>Length:</td> <td>160.5</td> <td></td> </tr> <tr> <td>Outside Ø:</td> <td>94.0</td> <td></td> </tr> <tr> <td>Flange Ø:</td> <td>101.0</td> <td></td> </tr> <tr> <td>Flange depth:</td> <td>3.5 +1.2</td> <td></td> </tr> </table>		Liner/ Sleeve		Length:	160.5		Outside Ø:	94.0		Flange Ø:	101.0		Flange depth:	3.5 +1.2		<table border="1"> <tr> <td></td> <td>Piston</td> <td></td> </tr> <tr> <td>Length:</td> <td>99.0</td> <td></td> </tr> <tr> <td>Comp. height:</td> <td>52.0 -1.4</td> <td></td> </tr> </table>		Piston		Length:	99.0		Comp. height:	52.0 -1.4			<table border="1"> <tr> <td></td> <td>Rings</td> <td></td> </tr> <tr> <td>Top:</td> <td>2.5</td> <td rowspan="2">Ø : 27.0 Length: 73.9</td> </tr> <tr> <td>2nd:</td> <td>2.0</td> </tr> <tr> <td>oil:</td> <td>4.0</td> <td></td> </tr> </table>		Rings		Top:	2.5	Ø : 27.0 Length: 73.9	2nd:	2.0	oil:	4.0		
			Liner/ Sleeve																																						
		Length:	160.5																																						
Outside Ø:	94.0																																								
Flange Ø:	101.0																																								
Flange depth:	3.5 +1.2																																								
	Piston																																								
Length:	99.0																																								
Comp. height:	52.0 -1.4																																								
	Rings																																								
Top:	2.5	Ø : 27.0 Length: 73.9																																							
2nd:	2.0																																								
oil:	4.0																																								
		Reference no.:	Reference no.:	Reference no.:	Reference no.:	Reference no.:																																			
		11461-54010		13101-54010 13101-54012 13103-54010	13011-54010 13011-54020 13011-54021 13013-54020	90999-70048 90999-73069 90999-73083																																			
NM-Motorservice Article no./ Artikelnummer/ Modelo número/ статья номер	NM-Motorservice Article no.:	NM-Motorservice Article no.:	NM-Motorservice Article no.:	NM-Motorservice Article no.:	NM-Motorservice Article no.:	NM-Motorservice Article no.:																																			
	LBS 36300 F LBS 36300 S superseded by LBS 36400 F LBS 36400 S	LB 36300 F LB 36300 S	KBS 36300 superseded by KBS 36400	KB 36300	KR 36300	PB 36300																																			

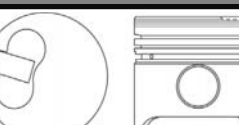

ENGINE TYPE Motortyp/ tipo de motor/ тип двигателя	LINER KIT Liner Kit/ camisas de los cilindros/ Лайнер комплект	CYL. LINER Zylinderlaufbuchse/ camisas de los cilindros/ втулка цилиндра	PISTON + RINGS Kolben + Ringe/ Pistón + Anillos/ поршень и кольца	PISTON SET Kolben Set/ Pistón Set/ поршневой	RINGS SET Ring Set/ Anillos Set/ кольца	PIN Pin/ Perno/ Пин																																			
L LN40 BULIZZARD • CROWN • HIACE • HILUX TOYOACE (LD10 • LH11/20/30/50/60/70 • LN3#/4# • LS110 • LY20/30) 1981-1983 2,188 cc 4 cyl 90.0 mm Bore Ø		<table border="1"> <tr> <td></td> <td>Liner/ Sleeve</td> <td></td> </tr> <tr> <td>Length:</td> <td>160.5</td> <td></td> </tr> <tr> <td>Outside Ø:</td> <td>94.0</td> <td></td> </tr> <tr> <td>Flange Ø:</td> <td>101.0</td> <td></td> </tr> <tr> <td>Flange depth:</td> <td>3.5 +1.2</td> <td></td> </tr> </table>		Liner/ Sleeve		Length:	160.5		Outside Ø:	94.0		Flange Ø:	101.0		Flange depth:	3.5 +1.2		<table border="1"> <tr> <td></td> <td>Piston</td> <td></td> </tr> <tr> <td>Length:</td> <td>99.0</td> <td></td> </tr> <tr> <td>Comp. height:</td> <td>52.0 -1.4</td> <td></td> </tr> </table>		Piston		Length:	99.0		Comp. height:	52.0 -1.4			<table border="1"> <tr> <td></td> <td>Rings</td> <td></td> </tr> <tr> <td>Top:</td> <td>2.0</td> <td rowspan="2">Ø : 27.0 Length: 73.9</td> </tr> <tr> <td>2nd:</td> <td>2.0</td> </tr> <tr> <td>oil:</td> <td>4.0</td> <td></td> </tr> </table>		Rings		Top:	2.0	Ø : 27.0 Length: 73.9	2nd:	2.0	oil:	4.0		
			Liner/ Sleeve																																						
		Length:	160.5																																						
Outside Ø:	94.0																																								
Flange Ø:	101.0																																								
Flange depth:	3.5 +1.2																																								
	Piston																																								
Length:	99.0																																								
Comp. height:	52.0 -1.4																																								
	Rings																																								
Top:	2.0	Ø : 27.0 Length: 73.9																																							
2nd:	2.0																																								
oil:	4.0																																								
		Reference no.:	Reference no.:	Reference no.:	Reference no.:	Reference no.:																																			
		11461-54010		13101-54020 13101-54021 13103-54020 13103-54021	13011-54030 13011-54031 13011-54040/1 13011-54042 13011-54080 13013-54040/1	90999-70048 90999-73069 90999-73083																																			
NM-Motorservice Article no./ Artikelnummer/ Modelo número/ статья номер	NM-Motorservice Article no.:	NM-Motorservice Article no.:	NM-Motorservice Article no.:	NM-Motorservice Article no.:	NM-Motorservice Article no.:	NM-Motorservice Article no.:																																			
	LBS 36350 F LBS 36350 S superseded by LBS 36400 F LBS 36400 S	LB 36350 F LB 36350 S	KBS 36350 superseded by KBS 36400	KB 36350 replaced by KB 36400	KR 36350	PB 36350																																			

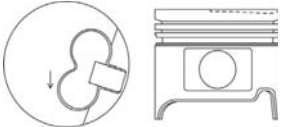

ENGINE TYPE Motortyp/ tipo de motor/ тип двигателя	LINER KIT Liner Kit/ camisas de los cilindros/ Лайнер комплект	CYL. LINER Zylinderlaufbuchse/ camisas de los cilindros/ втулка цилиндра	PISTON + RINGS Kolben + Ringe/ Pistón + Anillos/ поршень и кольца	PISTON SET Kolben Set/ Pistón Set/ поршневой	RINGS SET Ring Set/ Anillos Set/ кольца	PIN Pin/ Perno/ Пин																																					
L LN50 BULIZZARD • CROWN • HIACE • HILUX • (LD10 • LH11/50/60/70 • LN 30/40/50/55 • LS110) 1982-1985 2,188 cc 4 cyl 90.0 mm Bore Ø		<table border="1"> <tr> <td></td> <td>Liner/ Sleeve</td> <td></td> </tr> <tr> <td>Length:</td> <td>160.5</td> <td></td> </tr> <tr> <td>Outside Ø:</td> <td>94.0</td> <td></td> </tr> <tr> <td>Flange Ø:</td> <td>101.0</td> <td></td> </tr> <tr> <td>Flange depth:</td> <td>3.5 +1.2</td> <td></td> </tr> </table>		Liner/ Sleeve		Length:	160.5		Outside Ø:	94.0		Flange Ø:	101.0		Flange depth:	3.5 +1.2		<table border="1"> <tr> <td></td> <td>Piston</td> <td></td> </tr> <tr> <td>Length:</td> <td></td> <td>99.0</td> </tr> <tr> <td>Comp. height:</td> <td></td> <td>52.0 -1.4</td> </tr> </table>		Piston		Length:		99.0	Comp. height:		52.0 -1.4		<table border="1"> <tr> <td></td> <td>Rings</td> <td></td> </tr> <tr> <td>Top:</td> <td></td> <td>2.0</td> </tr> <tr> <td>2nd: oil:</td> <td></td> <td>2.0 4.0</td> </tr> </table>		Rings		Top:		2.0	2nd: oil:		2.0 4.0	<table border="1"> <tr> <td>Ø:</td> <td>27.0</td> </tr> <tr> <td>Length:</td> <td>73.5</td> </tr> </table>	Ø:	27.0	Length:	73.5
			Liner/ Sleeve																																								
Length:	160.5																																										
Outside Ø:	94.0																																										
Flange Ø:	101.0																																										
Flange depth:	3.5 +1.2																																										
	Piston																																										
Length:		99.0																																									
Comp. height:		52.0 -1.4																																									
	Rings																																										
Top:		2.0																																									
2nd: oil:		2.0 4.0																																									
Ø:	27.0																																										
Length:	73.5																																										
	Reference no.:	Reference no.:	Reference no.:	Reference no.:	Reference no.:																																						
	11461-54010		13101-54031 13101-54040 13103-54040	13011-54030 13011-54031 13011-54040/1 13011-54042 13011-54080 13013-54040/1	90999-70048 90999-73069 90999-73083																																						
NM-Motorservice Article no./ Artikelnummer/ Modelo número/ статья номер	NM-Motorservice Article no.:	NM-Motorservice Article no.:	NM-Motorservice Article no.:	NM-Motorservice Article no.:	NM-Motorservice Article no.:	NM-Motorservice Article no.:																																					
	LBS 36400 F LBS 36400 S	LB 36400 F LB 36400 S	KBS 36400	KB 36400	KR 36400	PB 36400																																					

ENGINE TYPE Motortyp/ tipo de motor/ тип двигателя	LINER KIT Liner Kit/ camisas de los cilindros/ Лайнер комплект	CYL. LINER Zylinderlaufbuchse/ camisas de los cilindros/ втулка цилиндра	PISTON + RINGS Kolben + Ringe/ Pistón + Anillos/ поршень и кольца	PISTON SET Kolben Set/ Pistón Set/ поршневой	RINGS SET Ring Set/ Anillos Set/ кольца	PIN Pin/ Perno/ Пин																																					
2L DYNA • 100/150 • HILUX • LAND CRUI- SER • 4RUNNER (LH5#/6#/71/80 • LJ70 LN5#/6# • LY31/60) 1983-1995 2,466 cc 4 cyl 92.0 mm Bore Ø		<table border="1"> <tr> <td></td> <td>Flanged</td> <td>No flange</td> </tr> <tr> <td>Length:</td> <td>160.5</td> <td>160.5</td> </tr> <tr> <td>Outside Ø:</td> <td>96.0</td> <td>96.0</td> </tr> <tr> <td>Flange Ø:</td> <td>100.7</td> <td></td> </tr> <tr> <td>Flange depth:</td> <td>3.5 +1.0</td> <td></td> </tr> </table>		Flanged	No flange	Length:	160.5	160.5	Outside Ø:	96.0	96.0	Flange Ø:	100.7		Flange depth:	3.5 +1.0		<table border="1"> <tr> <td></td> <td>Piston</td> <td></td> </tr> <tr> <td>Length:</td> <td></td> <td>86.2</td> </tr> <tr> <td>Comp. height:</td> <td></td> <td>49.3 -1.5</td> </tr> </table>		Piston		Length:		86.2	Comp. height:		49.3 -1.5		<table border="1"> <tr> <td></td> <td>Rings</td> <td></td> </tr> <tr> <td>Top:</td> <td></td> <td>2.0</td> </tr> <tr> <td>2nd: oil:</td> <td></td> <td>2.0 4.0</td> </tr> </table>		Rings		Top:		2.0	2nd: oil:		2.0 4.0	<table border="1"> <tr> <td>Ø:</td> <td>27.0</td> </tr> <tr> <td>Length:</td> <td>74.0</td> </tr> </table>	Ø:	27.0	Length:	74.0
			Flanged	No flange																																							
Length:	160.5	160.5																																									
Outside Ø:	96.0	96.0																																									
Flange Ø:	100.7																																										
Flange depth:	3.5 +1.0																																										
	Piston																																										
Length:		86.2																																									
Comp. height:		49.3 -1.5																																									
	Rings																																										
Top:		2.0																																									
2nd: oil:		2.0 4.0																																									
Ø:	27.0																																										
Length:	74.0																																										
	Reference no.:	Reference no.:	Reference no.:	Reference no.:	Reference no.:																																						
	11461-54030 11461-54060		13101-54060 13103-54060 13104-54060 13105-54060	13011-54050 13011-54060/1/2 13011-54090 13011-54100 13013-54060/1/2 13013/4/5-54100	90999-70048 90999-73069 90999-73083																																						
NM-Motorservice Article no./ Artikelnummer/ Modelo número/ статья номер	NM-Motorservice Article no.:	NM-Motorservice Article no.:	NM-Motorservice Article no.:	NM-Motorservice Article no.:	NM-Motorservice Article no.:	NM-Motorservice Article no.:																																					
	LBS 34000 F LBS 34000 S LBS 34000 P	LB 34000 F LB 34000 S LB 34000 P	KBS 34000	KB 34000	KR 34000	PB 34000																																					

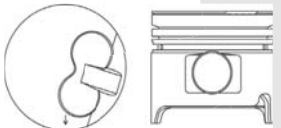
ENGINE TYPE Motortyp/ tipo de motor/ тип двигателя	LINER KIT Liner Kit/ camisas de los cilindros/ Лайнер комплект	CYL. LINER Zylinderlaufbuchse/ camisas de los cilindros/ втулка цилиндра	PISTON + RINGS Kolben + Ringe/ Pistón + Anillos/ поршень и кольца	PISTON SET Kolben Set/ Pistón Set/ поршневой	RINGS SET Ring Set/ Anillos Set/ кольца	PIN Pin/ Perno/ Пин																																					
2LT 4RUNNER (LN56/6# • LJ7#) 1984-1990 2,466 cc 4 cyl 92.0 mm Bore Ø		<table border="1"> <tr> <td></td> <td>Flanged</td> <td>No flange</td> </tr> <tr> <td>Length:</td> <td>160.5</td> <td>160.5</td> </tr> <tr> <td>Outside Ø:</td> <td>96.0</td> <td>96.0</td> </tr> <tr> <td>Flange Ø:</td> <td>100.7</td> <td></td> </tr> <tr> <td>Flange depth:</td> <td>3.5 +1.0</td> <td></td> </tr> </table>		Flanged	No flange	Length:	160.5	160.5	Outside Ø:	96.0	96.0	Flange Ø:	100.7		Flange depth:	3.5 +1.0		<table border="1"> <tr> <td></td> <td>Piston</td> <td></td> </tr> <tr> <td>Length:</td> <td></td> <td>86.2</td> </tr> <tr> <td>Comp. height:</td> <td></td> <td>49.2 -2.0</td> </tr> </table>		Piston		Length:		86.2	Comp. height:		49.2 -2.0		<table border="1"> <tr> <td></td> <td>Rings</td> <td></td> </tr> <tr> <td>Top:</td> <td></td> <td>2.0</td> </tr> <tr> <td>2nd: oil:</td> <td></td> <td>2.0 4.0</td> </tr> </table>		Rings		Top:		2.0	2nd: oil:		2.0 4.0	<table border="1"> <tr> <td>Ø:</td> <td>29.0</td> </tr> <tr> <td>Length:</td> <td>74.0</td> </tr> </table>	Ø:	29.0	Length:	74.0
			Flanged	No flange																																							
Length:	160.5	160.5																																									
Outside Ø:	96.0	96.0																																									
Flange Ø:	100.7																																										
Flange depth:	3.5 +1.0																																										
	Piston																																										
Length:		86.2																																									
Comp. height:		49.2 -2.0																																									
	Rings																																										
Top:		2.0																																									
2nd: oil:		2.0 4.0																																									
Ø:	29.0																																										
Length:	74.0																																										
	Reference no.:	Reference no.:	Reference no.:	Reference no.:	Reference no.:																																						
	11461-54030 11461-54060		13101-54030/50/80 13103-54030/50/80 13104-54030 13105-54030	13011-54050 13011-54060/1/2 13011-54090 13011-54100 13013-54060/1/2 13013/4/5-54100	90999-73094 90999-73118																																						
NM-Motorservice Article no./ Artikelnummer/ Modelo número/ статья номер	NM-Motorservice Article no.:	NM-Motorservice Article no.:	NM-Motorservice Article no.:	NM-Motorservice Article no.:	NM-Motorservice Article no.:	NM-Motorservice Article no.:																																					
	LBS 44800 FA LBS 44800 SA LBS 44800 PA	LB 44800 F LB 44800 S LB 44800 P	KBS 44800 A	KB 44800 A	KR 44800	PB 44800																																					

ENGINE TYPE Motor/typo/ tipo de motor/ тип двигателя	LINER KIT Liner Kit/ camisas de los cilindros/ Лайнер комплект	CYL. LINER Zylinderlaufbuchse/ camisas de los cilindros/ втулка цилиндра		PISTON + RINGS Kolben + Ringe/ Pistón + Anillos/ поршень и кольца		PISTON SET Kolben Set/ Pistón Set/ поршневой	RINGS SET Ring Set/ Anillos Set/ кольца		PIN Pin/ Perno/ Пин
2L II / 2L New COMUTER • DYNA • HIACE VAN • HILUX • (LH10#/11# • LY100 • LN5#/10# /85/90/110/145/150 • LXH12/22) 1988- 2,446 cc 4 cyl 92.0 mm Bore Ø			Flanged	No flange	Piston		Rings		
		Length: Outside Ø: Flange Ø: Flange depth:	160.5 96.0 100.7 3.5 +1.0	160.5 96.0	Length: Comp. height:	80.3 44.3 -2.5	Top: 2nd: oil:	2.0 2.0 4.0	Ø: Length:
		Reference no.:		Reference no.:		Reference no.:		Reference no.:	
		11461-54030 11461-54060				13101-54070 13103-54070 13104-54070 13105-54070		13011-54050 13011-54060/1/2 13011-54090 13011-54100 13013-54060/1/2 13013/4/5-54100	
NM-Motorservice Article no./ Artikelnummer/ Modelo número/ статья номер	NM-Motorservice Article no.:	NM-Motorservice Article no.:		NM-Motorservice Article no.:		NM-Motorservice Article no.:	NM-Motorservice Article no.:		NM-Motorservice Article no.:
	LBS 36550 FA LBS 36550 S A LBS 36550 PA	LB 36550 F LB 36550 S LB 36550 P		KBS 36550 A		KB 36550 A	KR 36550		PB 36550

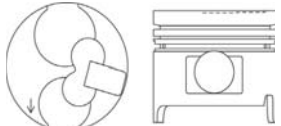

ENGINE TYPE Motor/typo/ tipo de motor/ тип двигателя	LINER KIT Liner Kit/ camisas de los cilindros/ Лайнер комплект	CYL. LINER Zylinderlaufbuchse/ camisas de los cilindros/ втулка цилиндра		PISTON + RINGS Kolben + Ringe/ Pistón + Anillos/ поршень и кольца		PISTON SET Kolben Set/ Pistón Set/ поршневой	RINGS SET Ring Set/ Anillos Set/ кольца		PIN Pin/ Perno/ Пин	
2LT / 2LIIT HIACE S.B.V • HILUX • LAND CRUISER (LJ7 • LN130/165/170 • LXH1#/#) 1990-1998 2,466 cc 4 cyl 92.0 mm Bore Ø			Flanged	No flange	Piston		Rings			
		Length: Outside Ø: Flange Ø: Flange depth:	160.5 96.0 100.7 3.5 +1.0	160.5 96.0	Length: Comp. height:	80.3 44.3 -2.4	Alfin and with oil gallery		Top: 2nd: oil:	2.0 2.0 4.0
		Reference no.:		Reference no.:		Reference no.:		Reference no.:		
		11461-54030 11461-54060				13101-54090/1 13101-54111 13103-54090/1 13104-54090/1 13105-54090/1		13011-54050 13011-54060/1/2 13011-54090 13011-54100 13013-54060/1/2 13013/4/5-54100		90999-73115
NM-Motorservice Article no./ Artikelnummer/ Modelo número/ статья номер	NM-Motorservice Article no.:	NM-Motorservice Article no.:		NM-Motorservice Article no.:		NM-Motorservice Article no.:	NM-Motorservice Article no.:		NM-Motorservice Article no.:	
	LBS 36600 FB LBS 36600 SB LBS 36600 PB	LB 36600 F LB 36600 S LB 36600 P		KBS 36600 B		KB 36600 B	KR 36600		PB 36600	



ENGINE TYPE Motor/typo/ tipo de motor/ тип двигателя	LINER KIT Liner Kit/ camisas de los cilindros/ Лайнер комплект	CYL. LINER Zylinderlaufbuchse/ camisas de los cilindros/ втулка цилиндра		PISTON + RINGS Kolben + Ringe/ Pistón + Anillos/ поршень и кольца		PISTON SET Kolben Set/ Pistón Set/ поршневой	RINGS SET Ring Set/ Anillos Set/ кольца		PIN Pin/ Perno/ Пин	
2LT New 2LIIT New HIACE S.B.V (LXH1#/#) 1998-2001 2,466 cc 4 cyl 92.0 mm Bore Ø			Flanged	No flange	Piston		Rings			
		Length: Outside Ø: Flange Ø: Flange depth:	160.5 96.0 100.7 3.5 +1.0	160.5 96.0	Length: Comp. height:	80.3 44.3 -0.2 -2.5	Alfin and with oil gallery		Top: 2nd: oil:	2.0 2.0 4.0
		Reference no.:		Reference no.:		Reference no.:		Reference no.:		
		11461-54030 11461-54060				13101-54140 13101-54141 13103-54140 13104-54140 13105-54140		13011-54050 13011-54060/1/2 13011-54090 13011-54100 13013-54060/1/2 13013/4/5-54100		90999-73115
NM-Motorservice Article no./ Artikelnummer/ Modelo número/ статья номер	NM-Motorservice Article no.:	NM-Motorservice Article no.:		NM-Motorservice Article no.:		NM-Motorservice Article no.:	NM-Motorservice Article no.:		NM-Motorservice Article no.:	
	LBS 36650 FB LBS 36650 SB LBS 36650 PB	LB 36650 F LB 36650 S LB 36650 P		KBS 36650 B		KB 36650 B	KR 36650		PB 36650	

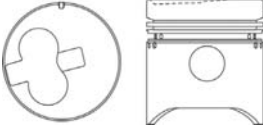

ENGINE TYPE	LINER KIT	CYL. LINER		PISTON + RINGS		PISTON SET	RINGS SET		PIN		
Motortyp/ tipo de motor/ тип двигателя	Liner Kit/ camisas de los cilindros/ Лайнер комплект	Zylinderlaufbuchse/ camisas de los cilindros/ втулка цилиндра		Kolben + Ringe/ Pistón + Anillos/ поршень и кольца		Kolben Set/ Pistón Set/ поршневой	Ring Set/ Anillos Set/ кольца		Pin/ Perno/ Пин		
2LT New 2LIIT New DYNA 100 • HIACE S.B.V • HILUX (LN 145/150 • LXH12/22 • LY100) 1998-2001 2,466 cc 4 cyl 92.0 mm Bore Ø			Flanged	No flange	Piston		Rings				
		Length: Outside Ø: Flange Ø: Flange depth:	160.5 96.0 100.7 3.5 +1.0	160.5 96.0	Length: Comp. height:	80.3 44.3 -0.8 -3.0	Top: 2nd: oil:	2.0 2.0 4.0	Ø: Length:	27.0 70.0	
		Reference no.:		Reference no.:		Reference no.:		Reference no.:		Reference no.:	
		11461-54030 11461-54060				13101-54130 13103-54130 13104-54130 13105-54130		13011-54050 13011-54060/1/2 13011-54090 13011-54100 13013-54060/1/2 13013/4/5-54100		90999-73114	
NM-Motorservice Article no./ Artikelnummer/ Modelo número/ статья номер	NM-Motorservice Article no.:	NM-Motorservice Article no.:		NM-Motorservice Article no.:		NM-Motorservice Article no.:		NM-Motorservice Article no.:		NM-Motorservice Article no.:	
	LBS 36700 FA LBS 36700 SA LBS 36700 PA	LB 36700 F LB 36700 S LB 36700 P		KBS 36700 A		KB 36700 A		KR 36700		PB 36700	

ENGINE TYPE	LINER KIT	CYL. LINER		PISTON + RINGS		PISTON SET	RINGS SET		PIN		
Motortyp/ tipo de motor/ тип двигателя	Liner Kit/ camisas de los cilindros/ Лайнер комплект	Zylinderlaufbuchse/ camisas de los cilindros/ втулка цилиндра		Kolben + Ringe/ Pistón + Anillos/ поршень и кольца		Kolben Set/ Pistón Set/ поршневой	Ring Set/ Anillos Set/ кольца		Pin/ Perno/ Пин		
2KD-FTV DYNA 150 • HIACE S.B.V • HILUX (KDN145/150 • KDY220/230 • KLN1#2# • KUN15/25) 2001- 2,494 cc 4 cyl 92.0 mm Bore Ø			Flanged	No flange	Piston		Rings				
		Length: Outside Ø: Flange Ø: Flange depth:	170.0 96.0 101.0 4.5	165.0 96.0	Length: Comp. height:	82.2 54.2 -6.7 -19.5	Alfin and with oil gallery		Top: 2nd: oil:	2.0 1.5 3.0	Ø: Length:
		Reference no.:		Reference no.:		Reference no.:		Reference no.:		Reference no.:	
						13101-0L020 13101-0L022 13101-30030 13101-30031 13103-30030 13103-30031		13011-0L020 13011-0L040 13011-30030 13011-30031 13011-30060 13011-30080 13013-30030 13013-30031		90999-73145 90999-73157	
NM-Motorservice Article no./ Artikelnummer/ Modelo número/ статья номер	NM-Motorservice Article no.:	NM-Motorservice Article no.:		NM-Motorservice Article no.:		NM-Motorservice Article no.:		NM-Motorservice Article no.:		NM-Motorservice Article no.:	
	LBS 50000 PB LBS 50000 SB	LB 50000 P LB 50000 S		KBS 50000 B		KB 50000 B		KR 50000		PB 50000	

ENGINE TYPE	LINER KIT	CYL. LINER		PISTON + RINGS		PISTON SET	RINGS SET		PIN		
Motortyp/ tipo de motor/ тип двигателя	Liner Kit/ camisas de los cilindros/ Лайнер комплект	Zylinderlaufbuchse/ camisas de los cilindros/ втулка цилиндра		Kolben + Ringe/ Pistón + Anillos/ поршень и кольца		Kolben Set/ Pistón Set/ поршневой	Ring Set/ Anillos Set/ кольца		Pin/ Perno/ Пин		
B 4 Rings LAND CRUISER (BJ4#) 1974-1975 2,977 cc 4 cyl 95.0 mm Bore Ø			Liner/ Sleeve		Piston		Rings				
		Length: Outside Ø: Flange Ø: Flange depth:	190.0 100.0 107.6 2.5 +1.2		Length: Comp. height:	101.3 52.3 -2.6	Top: 2nd: 3rd: oil:	2.5 2.5 2.5 4.5	Ø: Length:	29.0 79.0	
		Reference no.:		Reference no.:		Reference no.:		Reference no.:		Reference no.:	
		11461-56010				13081-56011 13085-56011		13011-56011 13015-56011		90999-73065 90999-73121 90999-73131	
NM-Motorservice Article no./ Artikelnummer/ Modelo número/ статья номер	NM-Motorservice Article no.:	NM-Motorservice Article no.:		NM-Motorservice Article no.:		NM-Motorservice Article no.:		NM-Motorservice Article no.:		NM-Motorservice Article no.:	
	LBS 36800 F LBS 36800 S	LB 36800 F LB 36800 S		KBS 36800		KB 36800		KR 36800		PB 36800	

ENGINE TYPE Motor/typo/ tipo de motor/ тип двигателя	LINER KIT Liner Kit/ camisas de los cilindros/ Лайнер комплект	CYL. LINER Zylinderlaufbuchse/ camisas de los cilindros/ втулка цилиндра		PISTON + RINGS Kolben + Ringe/ Pistón + Anillos/ поршень и кольца		PISTON SET Kolben Set/ Pistón Set/ поршневой	RINGS SET Ring Set/ Anillos Set/ кольца		PIN Pin/ Perno/ Пин	
B 3 Rings DYNA • LAND CRUISER (BJ4#40/43 • BU2#20/25/30/60/63/70/ 75/80) 1977-1986 2,977 cc 4 cyl 95.0 mm Bore Ø			Liner/ Sleeve	Piston			Rings		Ø : 29.0 Length: 79.1	
		Length: Outside Ø: Flange Ø: Flange depth:	190.0 102.0 107.6 2.5 +1.0	Length: Comp. height:	101.3 52.3 -3.1 -4.4		Top: 2nd: oil:	2.5 2.5 4.5		
		Reference no.:		Reference no.:	Reference no.:	Reference no.:	Reference no.:	Reference no.:		
						13101-56013 13101-56020 13101-56021 13101-56030/1 13105-56021 13105-56030	13011-56012 13011-56013 13011-56021 13011-56022 13011-56030 13015-56012/3	90999-73065 90999-73121 90999-73131		
NM-Motorservice Article no./ Artikelnummer/ Modelo número/ статья номер	NM-Motorservice Article no.:	NM-Motorservice Article no.:		NM-Motorservice Article no.:		NM-Motorservice Article no.:	NM-Motorservice Article no.:	NM-Motorservice Article no.:		NM-Motorservice Article no.:
	LBS 36850 F LBS 36850 S	LB 36850 F LB 36850 S		KBS 36850		KB 36850	KR 36850	PB 36850		



ENGINE TYPE Motor/typo/ tipo de motor/ тип двигателя	LINER KIT Liner Kit/ camisas de los cilindros/ Лайнер комплект	CYL. LINER Zylinderlaufbuchse/ camisas de los cilindros/ втулка цилиндра		PISTON + RINGS Kolben + Ringe/ Pistón + Anillos/ поршень и кольца		PISTON SET Kolben Set/ Pistón Set/ поршневой	RINGS SET Ring Set/ Anillos Set/ кольца		PIN Pin/ Perno/ Пин	
B(3) New 2,977 cc 4 cyl 95.0 mm Bore Ø			Flanged	No flange	Piston		Rings		Ø : 29.0 Length: 72.0	
		Length: Outside Ø: Flange Ø: Flange depth:	190.0 102.0 107.6 2.5 +1.0		Length: Comp. height:	101.2 52.2 -2.5 -4.2	Top: 2nd: oil:	2.5 2.0 4.0		
		Reference no.:		Reference no.:	Reference no.:	Reference no.:	Reference no.:	Reference no.:		
		11461-56020				13101-56050	13011-56040 13011-56041 13013-56040 13014-56040 13015-56040	90999-73065 90999-73121 90999-73131		
NM-Motorservice Article no./ Artikelnummer/ Modelo número/ статья номер	NM-Motorservice Article no.:	NM-Motorservice Article no.:		NM-Motorservice Article no.:		NM-Motorservice Article no.:	NM-Motorservice Article no.:	NM-Motorservice Article no.:		NM-Motorservice Article no.:
	LBS 36900 FA LBS 36900 SA	LB 36900 F LB 36900 S		KBS 36900 A		KB 36900 A	KR 36900	PB 36900		



ENGINE TYPE Motor/typo/ tipo de motor/ тип двигателя	LINER KIT Liner Kit/ camisas de los cilindros/ Лайнер комплект	CYL. LINER Zylinderlaufbuchse/ camisas de los cilindros/ втулка цилиндра		PISTON + RINGS Kolben + Ringe/ Pistón + Anillos/ поршень и кольца		PISTON SET Kolben Set/ Pistón Set/ поршневой	RINGS SET Ring Set/ Anillos Set/ кольца		PIN Pin/ Perno/ Пин	
11B DYNA (BU61/65/76/81/86) 1985-1987 2,977 cc 4 cyl 95.0 mm Bore Ø			Flanged	No flange	Piston		Rings		Ø : 34.0 Length: 75.0	
		Length: Outside Ø: Flange Ø: Flange depth:	190.0 99.0 104.6 2.5 +1.0	192.0 99.0	Length: Comp. height:	98.2 63.2 -18.0	Top: 2nd: oil:	2.5 2.5 4.5		
		Reference no.:		Reference no.:	Reference no.:	Reference no.:	Reference no.:	Reference no.:		
		11461-56030 11462-56060				13101-56041 13101-56042	13011-56012 13011-56013 13011-56021/2 13011-56030 13015-56012/3	90999-73099		
NM-Motorservice Article no./ Artikelnummer/ Modelo número/ статья номер	NM-Motorservice Article no.:	NM-Motorservice Article no.:		NM-Motorservice Article no.:		NM-Motorservice Article no.:	NM-Motorservice Article no.:	NM-Motorservice Article no.:		NM-Motorservice Article no.:
	LBS 36950 F LBS 36950 S LBS 36950 P	LB 36950 F LB 36950 S LB 36950 P		KBS 36950		KB 36950	KR 36950	PB 36950		



ENGINE TYPE Motortyp/ tipo de motor/ тип двигателя	LINER KIT Liner Kit/ camisas de los cilindros/ Лайнер комплект	CYL. LINER Zylinderlaufbuchse/ camisas de los cilindros/ втулка цилиндра	PISTON + RINGS Kolben + Ringe/ Pistón + Anillos/ поршень и кольца	PISTON SET Kolben Set/ Pistón Set/ поршневой	RINGS SET Ring Set/ Anillos Set/ кольца	PIN Pin/ Perno/ Пин																																												
11B DYNA 200 (BU76/84) 1988-1992 2,977 cc 4 cyl 95.0 mm Bore Ø		<table border="1"> <tr> <td></td> <td>Flanged</td> <td>No flange</td> <td></td> </tr> <tr> <td>Length:</td> <td>190.0</td> <td>192.0</td> <td></td> </tr> <tr> <td>Outside Ø:</td> <td>99.0</td> <td>99.0</td> <td></td> </tr> <tr> <td>Flange Ø:</td> <td>104.6</td> <td></td> <td></td> </tr> <tr> <td>Flange depth:</td> <td>2.5</td> <td></td> <td></td> </tr> <tr> <td></td> <td>+1.0</td> <td></td> <td></td> </tr> </table>		Flanged	No flange		Length:	190.0	192.0		Outside Ø:	99.0	99.0		Flange Ø:	104.6			Flange depth:	2.5				+1.0			<table border="1"> <tr> <td></td> <td>Piston</td> </tr> <tr> <td>Length:</td> <td>90.4</td> </tr> <tr> <td>Comp. height:</td> <td>55.4</td> </tr> <tr> <td></td> <td>-20.3</td> </tr> </table>		Piston	Length:	90.4	Comp. height:	55.4		-20.3		<table border="1"> <tr> <td></td> <td>Rings</td> </tr> <tr> <td>Top:</td> <td>2.5</td> </tr> <tr> <td>2nd:</td> <td>2.0</td> </tr> <tr> <td>oil:</td> <td>4.0</td> </tr> <tr> <td>Ø:</td> <td>32.0</td> </tr> <tr> <td>Length:</td> <td>72.0</td> </tr> </table>		Rings	Top:	2.5	2nd:	2.0	oil:	4.0	Ø:	32.0	Length:	72.0	
			Flanged	No flange																																														
Length:	190.0	192.0																																																
Outside Ø:	99.0	99.0																																																
Flange Ø:	104.6																																																	
Flange depth:	2.5																																																	
	+1.0																																																	
	Piston																																																	
Length:	90.4																																																	
Comp. height:	55.4																																																	
	-20.3																																																	
	Rings																																																	
Top:	2.5																																																	
2nd:	2.0																																																	
oil:	4.0																																																	
Ø:	32.0																																																	
Length:	72.0																																																	
		Reference no.: 11461-56030 11462-56060	Reference no.: 13101-56060 13103-56060 13104-56060 13105-56060	Reference no.: 13011-56040 13011-56041 13013-56040 13014-56040 13015-56040	Reference no.: 90999-73116 90999-73124																																													
NM-Motorservice Article no./ Artikelnummer/ Modelo número/ статья номер	NM-Motorservice Article no.:	NM-Motorservice Article no.:	NM-Motorservice Article no.:	NM-Motorservice Article no.:	NM-Motorservice Article no.:	NM-Motorservice Article no.:																																												
	LBS 37000 FA LBS 37000 SA LBS 37000 PA	LB 37000 F LB 37000 S LB 37000 P	KBS 37000 A	KB 37000 A	KR 37000	PB 37000																																												

ENGINE TYPE Motortyp/ tipo de motor/ тип двигателя	LINER KIT Liner Kit/ camisas de los cilindros/ Лайнер комплект	CYL. LINER Zylinderlaufbuchse/ camisas de los cilindros/ втулка цилиндра	PISTON + RINGS Kolben + Ringe/ Pistón + Anillos/ поршень и кольца	PISTON SET Kolben Set/ Pistón Set/ поршневой	RINGS SET Ring Set/ Anillos Set/ кольца	PIN Pin/ Perno/ Пин																																														
3L COMPUTER • DYNA 150 • HIACE VAN • HILUX (LH103/105/113/115/125 LN57/ 67 • LY61/211) 1988-2001 2,779 cc 4 cyl 96.0 mm Bore Ø		<table border="1"> <tr> <td></td> <td>Flanged</td> <td>No flange</td> <td></td> </tr> <tr> <td>Length:</td> <td>190.0</td> <td>190.0</td> <td></td> </tr> <tr> <td>Outside Ø:</td> <td>100.0</td> <td>100.0</td> <td></td> </tr> <tr> <td>Flange Ø:</td> <td>107.6</td> <td></td> <td></td> </tr> <tr> <td>Flange depth:</td> <td>2.5</td> <td></td> <td></td> </tr> <tr> <td></td> <td>+1.0</td> <td></td> <td></td> </tr> </table>		Flanged	No flange		Length:	190.0	190.0		Outside Ø:	100.0	100.0		Flange Ø:	107.6			Flange depth:	2.5				+1.0			<table border="1"> <tr> <td></td> <td>Piston</td> </tr> <tr> <td>Length:</td> <td>80.3</td> </tr> <tr> <td>Comp. height:</td> <td>42.3</td> </tr> <tr> <td></td> <td>-0.15</td> </tr> <tr> <td></td> <td>-2.0</td> </tr> </table>		Piston	Length:	80.3	Comp. height:	42.3		-0.15		-2.0		<table border="1"> <tr> <td></td> <td>Rings</td> </tr> <tr> <td>Top:</td> <td>2.0</td> </tr> <tr> <td>2nd:</td> <td>2.0</td> </tr> <tr> <td>oil:</td> <td>4.0</td> </tr> <tr> <td>Ø:</td> <td>29.0</td> </tr> <tr> <td>Length:</td> <td>73.9</td> </tr> </table>		Rings	Top:	2.0	2nd:	2.0	oil:	4.0	Ø:	29.0	Length:	73.9	
			Flanged	No flange																																																
Length:	190.0	190.0																																																		
Outside Ø:	100.0	100.0																																																		
Flange Ø:	107.6																																																			
Flange depth:	2.5																																																			
	+1.0																																																			
	Piston																																																			
Length:	80.3																																																			
Comp. height:	42.3																																																			
	-0.15																																																			
	-2.0																																																			
	Rings																																																			
Top:	2.0																																																			
2nd:	2.0																																																			
oil:	4.0																																																			
Ø:	29.0																																																			
Length:	73.9																																																			
		Reference no.: 11461-54090 11461-54100	Reference no.: 13101-54100 13101-54101 13103-54100 13103-54101	Reference no.: 13011-54120 13013-54120	Reference no.: 90999-73115																																															
NM-Motorservice Article no./ Artikelnummer/ Modelo número/ статья номер	NM-Motorservice Article no.:	NM-Motorservice Article no.:	NM-Motorservice Article no.:	NM-Motorservice Article no.:	NM-Motorservice Article no.:	NM-Motorservice Article no.:																																														
	LBS 37050 FA LBS 37050 SA LBA 37050 PA	LB 37050 F LB 37050 S LB 37050 P	KBS 37050 A	KB 37050 A	KR 37050	PB 37050																																														

ENGINE TYPE Motortyp/ tipo de motor/ тип двигателя	LINER KIT Liner Kit/ camisas de los cilindros/ Лайнер комплект	CYL. LINER Zylinderlaufbuchse/ camisas de los cilindros/ втулка цилиндра	PISTON + RINGS Kolben + Ringe/ Pistón + Anillos/ поршень и кольца	PISTON SET Kolben Set/ Pistón Set/ поршневой	RINGS SET Ring Set/ Anillos Set/ кольца	PIN Pin/ Perno/ Пин																																					
1Z 2,953 cc 4 cyl 96.0 mm Bore Ø		<table border="1"> <tr> <td></td> <td>Liner/ Sleeve</td> <td></td> </tr> <tr> <td>Length:</td> <td>182.5</td> <td></td> </tr> <tr> <td>Outside Ø:</td> <td>100.0</td> <td></td> </tr> <tr> <td>Flange Ø:</td> <td>105.8</td> <td></td> </tr> <tr> <td>Flange depth:</td> <td>8.0</td> <td></td> </tr> </table>		Liner/ Sleeve		Length:	182.5		Outside Ø:	100.0		Flange Ø:	105.8		Flange depth:	8.0		<table border="1"> <tr> <td></td> <td>Piston</td> </tr> <tr> <td>Length:</td> <td>94.4</td> </tr> <tr> <td>Comp. height:</td> <td>56.5</td> </tr> <tr> <td></td> <td>-7.0</td> </tr> <tr> <td></td> <td>-15.6</td> </tr> </table>		Piston	Length:	94.4	Comp. height:	56.5		-7.0		-15.6		<table border="1"> <tr> <td></td> <td>Rings</td> </tr> <tr> <td>Top:</td> <td>2.0</td> </tr> <tr> <td>2nd:</td> <td>2.0</td> </tr> <tr> <td>oil:</td> <td>4.0</td> </tr> <tr> <td>Ø:</td> <td>32.0</td> </tr> <tr> <td>Length:</td> <td>77.0</td> </tr> </table>		Rings	Top:	2.0	2nd:	2.0	oil:	4.0	Ø:	32.0	Length:	77.0	
			Liner/ Sleeve																																								
Length:	182.5																																										
Outside Ø:	100.0																																										
Flange Ø:	105.8																																										
Flange depth:	8.0																																										
	Piston																																										
Length:	94.4																																										
Comp. height:	56.5																																										
	-7.0																																										
	-15.6																																										
	Rings																																										
Top:	2.0																																										
2nd:	2.0																																										
oil:	4.0																																										
Ø:	32.0																																										
Length:	77.0																																										
		Reference no.: 11461-78360	Reference no.: 13101-78300 13101-96300	Reference no.: 13011-78300	Reference no.: 90384-32950 90384-32951																																						
NM-Motorservice Article no./ Artikelnummer/ Modelo número/ статья номер	NM-Motorservice Article no.:	NM-Motorservice Article no.:	NM-Motorservice Article no.:	NM-Motorservice Article no.:	NM-Motorservice Article no.:	NM-Motorservice Article no.:																																					
	LBS 37100 F LBS 37100 S	LB 37100 F LB 37100 S	KBS 37100	KB 37100	KR 37100	PB 37100																																					

ENGINE TYPE Motor/typo/ tipo de motor/ тип двигателя	LINER KIT Liner Kit/ camisas de los cilindros/ Лайнер комплект	CYL. LINER Zylinderlaufbuchse/ camisas de los cilindros/ втулка цилиндра	PISTON + RINGS Kolben + Ringe/ Pistón + Anillos/ поршень и кольца	PISTON SET Kolben Set/ Pistón Set/ поршневой	RINGS SET Ring Set/ Anillos Set/ кольца	PIN Pin/ Perno/ Пин																																																														
1KZ-TE LAND CRUISER 90 (KZJ 9#) 1996-2000 2,982 cc 4 cyl 96.0 mm Bore Ø		<table border="1"> <tr> <td></td> <td>Liner/ Sleeve</td> <td></td> </tr> <tr> <td>Length:</td> <td>170.0</td> <td></td> </tr> <tr> <td>Outside Ø:</td> <td>99.0</td> <td></td> </tr> <tr> <td>Flange Ø:</td> <td>105.0</td> <td></td> </tr> <tr> <td>Flange depth:</td> <td>5.0</td> <td></td> </tr> </table>		Liner/ Sleeve		Length:	170.0		Outside Ø:	99.0		Flange Ø:	105.0		Flange depth:	5.0		<table border="1"> <tr> <td></td> <td>Piston</td> <td></td> </tr> <tr> <td>Length:</td> <td>80.7</td> <td></td> </tr> <tr> <td>Comp. height:</td> <td>45.7</td> <td></td> </tr> <tr> <td></td> <td>-2.5</td> <td></td> </tr> </table>		Piston		Length:	80.7		Comp. height:	45.7			-2.5		Alfin and with oil gallery head anodized	<table border="1"> <tr> <td></td> <td>Rings</td> <td></td> </tr> <tr> <td>Top:</td> <td>2.0</td> <td rowspan="3"> Ø : 34.0 Length: 73.0 </td> </tr> <tr> <td>2nd:</td> <td>2.0</td> </tr> <tr> <td>oil:</td> <td>3.0</td> </tr> </table>		Rings		Top:	2.0	Ø : 34.0 Length: 73.0	2nd:	2.0	oil:	3.0	<table border="1"> <tr> <td>Reference no.:</td> <td>Reference no.:</td> <td>Reference no.:</td> <td>Reference no.:</td> <td>Reference no.:</td> </tr> <tr> <td>11461-78300</td> <td></td> <td>13101-67030</td> <td>13011-67030</td> <td>90999-73136</td> </tr> <tr> <td>11461-78301</td> <td></td> <td>13103-67030</td> <td>13013-67030</td> <td></td> </tr> <tr> <td></td> <td></td> <td>13104-67030</td> <td>13014-67030</td> <td></td> </tr> <tr> <td></td> <td></td> <td>13105-67030</td> <td>13015-67030</td> <td></td> </tr> </table>	Reference no.:	Reference no.:	Reference no.:	Reference no.:	Reference no.:	11461-78300		13101-67030	13011-67030	90999-73136	11461-78301		13103-67030	13013-67030				13104-67030	13014-67030				13105-67030	13015-67030	
			Liner/ Sleeve																																																																	
		Length:	170.0																																																																	
Outside Ø:	99.0																																																																			
Flange Ø:	105.0																																																																			
Flange depth:	5.0																																																																			
	Piston																																																																			
Length:	80.7																																																																			
Comp. height:	45.7																																																																			
	-2.5																																																																			
	Rings																																																																			
Top:	2.0	Ø : 34.0 Length: 73.0																																																																		
2nd:	2.0																																																																			
oil:	3.0																																																																			
Reference no.:	Reference no.:	Reference no.:	Reference no.:	Reference no.:																																																																
11461-78300		13101-67030	13011-67030	90999-73136																																																																
11461-78301		13103-67030	13013-67030																																																																	
		13104-67030	13014-67030																																																																	
		13105-67030	13015-67030																																																																	
																																																																				
NM-Motorservice Article no./ Artikelnummer/ Modelo número/ статья номер	NM-Motorservice Article no.:	NM-Motorservice Article no.:	NM-Motorservice Article no.:	NM-Motorservice Article no.:	NM-Motorservice Article no.:	NM-Motorservice Article no.:																																																														
	LBS 14000 FB LBS 14000 FB	LB 14000 F LB 14000 S	KBS 14000 B	KB 14000 B	KR 14000	PB 14000																																																														



ENGINE TYPE Motor/typo/ tipo de motor/ тип двигателя	LINER KIT Liner Kit/ camisas de los cilindros/ Лайнер комплект	CYL. LINER Zylinderlaufbuchse/ camisas de los cilindros/ втулка цилиндра	PISTON + RINGS Kolben + Ringe/ Pistón + Anillos/ поршень и кольца	PISTON SET Kolben Set/ Pistón Set/ поршневой	RINGS SET Ring Set/ Anillos Set/ кольца	PIN Pin/ Perno/ Пин																																																																	
1KZ-TE New LAND CRUISER 90 (KZJ 9#) 2000-2002 2,982 cc 4 cyl 96.0 mm Bore Ø		<table border="1"> <tr> <td></td> <td>Liner/ Sleeve</td> <td></td> </tr> <tr> <td>Length:</td> <td>170.0</td> <td></td> </tr> <tr> <td>Outside Ø:</td> <td>99.0</td> <td></td> </tr> <tr> <td>Flange Ø:</td> <td>105.0</td> <td></td> </tr> <tr> <td>Flange depth:</td> <td>5.0</td> <td></td> </tr> </table>		Liner/ Sleeve		Length:	170.0		Outside Ø:	99.0		Flange Ø:	105.0		Flange depth:	5.0		<table border="1"> <tr> <td></td> <td>Piston</td> <td></td> </tr> <tr> <td>Length:</td> <td>80.7</td> <td></td> </tr> <tr> <td>Comp. height:</td> <td>45.8</td> <td></td> </tr> <tr> <td></td> <td>-0.9</td> <td></td> </tr> <tr> <td></td> <td>-2.4</td> <td></td> </tr> </table>		Piston		Length:	80.7		Comp. height:	45.8			-0.9			-2.4		Alfin and with oil gallery head anodized	<table border="1"> <tr> <td></td> <td>Rings</td> <td></td> </tr> <tr> <td>Top:</td> <td>2.0</td> <td rowspan="3"> Ø : 34.0 Length: 73.0 </td> </tr> <tr> <td>2nd:</td> <td>2.0</td> </tr> <tr> <td>oil:</td> <td>3.0</td> </tr> </table>		Rings		Top:	2.0	Ø : 34.0 Length: 73.0	2nd:	2.0	oil:	3.0	<table border="1"> <tr> <td>Reference no.:</td> <td>Reference no.:</td> <td>Reference no.:</td> <td>Reference no.:</td> <td>Reference no.:</td> </tr> <tr> <td>11461-78300</td> <td></td> <td>13101-67050</td> <td>13011-67030</td> <td>90999-73136</td> </tr> <tr> <td>11461-78301</td> <td></td> <td>13103-67050</td> <td>13013-67030</td> <td></td> </tr> <tr> <td></td> <td></td> <td>13104-67050</td> <td>13014-67030</td> <td></td> </tr> <tr> <td></td> <td></td> <td>13105-67050</td> <td>13015-67030</td> <td></td> </tr> </table>	Reference no.:	Reference no.:	Reference no.:	Reference no.:	Reference no.:	11461-78300		13101-67050	13011-67030	90999-73136	11461-78301		13103-67050	13013-67030				13104-67050	13014-67030				13105-67050	13015-67030	
			Liner/ Sleeve																																																																				
		Length:	170.0																																																																				
Outside Ø:	99.0																																																																						
Flange Ø:	105.0																																																																						
Flange depth:	5.0																																																																						
	Piston																																																																						
Length:	80.7																																																																						
Comp. height:	45.8																																																																						
	-0.9																																																																						
	-2.4																																																																						
	Rings																																																																						
Top:	2.0	Ø : 34.0 Length: 73.0																																																																					
2nd:	2.0																																																																						
oil:	3.0																																																																						
Reference no.:	Reference no.:	Reference no.:	Reference no.:	Reference no.:																																																																			
11461-78300		13101-67050	13011-67030	90999-73136																																																																			
11461-78301		13103-67050	13013-67030																																																																				
		13104-67050	13014-67030																																																																				
		13105-67050	13015-67030																																																																				
																																																																							
NM-Motorservice Article no./ Artikelnummer/ Modelo número/ статья номер	NM-Motorservice Article no.:	NM-Motorservice Article no.:	NM-Motorservice Article no.:	NM-Motorservice Article no.:	NM-Motorservice Article no.:	NM-Motorservice Article no.:																																																																	
	LBS 14001 FB LBS 14001 SB	LB 14001 F LB 14001 S	KBS 14001 B	KB 14001 B	KR 14001	PB 14001																																																																	



ENGINE TYPE Motor/typo/ tipo de motor/ тип двигателя	LINER KIT Liner Kit/ camisas de los cilindros/ Лайнер комплект	CYL. LINER Zylinderlaufbuchse/ camisas de los cilindros/ втулка цилиндра	PISTON + RINGS Kolben + Ringe/ Pistón + Anillos/ поршень и кольца	PISTON SET Kolben Set/ Pistón Set/ поршневой	RINGS SET Ring Set/ Anillos Set/ кольца	PIN Pin/ Perno/ Пин																																																																
1KD-FTV LAND CRUISER 90/120 (KDJ12 • KZJ9#) 2000-2004 2,982 cc 4 cyl 96.0 mm Bore Ø		<table border="1"> <tr> <td></td> <td>Liner/ Sleeve</td> <td></td> </tr> <tr> <td>Length:</td> <td>170.0</td> <td>170.0</td> </tr> <tr> <td>Outside Ø:</td> <td>99.0</td> <td>99.0</td> </tr> <tr> <td>Flange Ø:</td> <td>105.0</td> <td></td> </tr> <tr> <td>Flange depth:</td> <td>5.0</td> <td></td> </tr> </table>		Liner/ Sleeve		Length:	170.0	170.0	Outside Ø:	99.0	99.0	Flange Ø:	105.0		Flange depth:	5.0		<table border="1"> <tr> <td></td> <td>Piston</td> <td></td> </tr> <tr> <td>Length:</td> <td>77.6</td> <td></td> </tr> <tr> <td>Comp. height:</td> <td>49.6</td> <td></td> </tr> <tr> <td></td> <td>-6.0</td> <td></td> </tr> <tr> <td></td> <td>-17.7</td> <td></td> </tr> </table>		Piston		Length:	77.6		Comp. height:	49.6			-6.0			-17.7		Alfin and with oil gallery head anodized	<table border="1"> <tr> <td></td> <td>Rings</td> <td></td> </tr> <tr> <td>Top:</td> <td>2.0</td> <td rowspan="3"> Ø : 34.0 Length: 73.0 </td> </tr> <tr> <td>2nd:</td> <td>1.5</td> </tr> <tr> <td>oil:</td> <td>3.0</td> </tr> </table>		Rings		Top:	2.0	Ø : 34.0 Length: 73.0	2nd:	1.5	oil:	3.0	<table border="1"> <tr> <td>Reference no.:</td> <td>Reference no.:</td> <td>Reference no.:</td> <td>Reference no.:</td> </tr> <tr> <td>13011-30020/21/22</td> <td></td> <td>13011-30040/50</td> <td></td> </tr> <tr> <td>13011-30051</td> <td></td> <td>13013-30020/21/22</td> <td></td> </tr> <tr> <td>13013-30020/21/22</td> <td></td> <td>13013-30051</td> <td></td> </tr> <tr> <td>13014-30020/21/22</td> <td></td> <td>13014-30051</td> <td></td> </tr> <tr> <td>13015-30020/21/22</td> <td></td> <td>13015-30051</td> <td></td> </tr> </table>	Reference no.:	Reference no.:	Reference no.:	Reference no.:	13011-30020/21/22		13011-30040/50		13011-30051		13013-30020/21/22		13013-30020/21/22		13013-30051		13014-30020/21/22		13014-30051		13015-30020/21/22		13015-30051	
			Liner/ Sleeve																																																																			
		Length:	170.0	170.0																																																																		
Outside Ø:	99.0	99.0																																																																				
Flange Ø:	105.0																																																																					
Flange depth:	5.0																																																																					
	Piston																																																																					
Length:	77.6																																																																					
Comp. height:	49.6																																																																					
	-6.0																																																																					
	-17.7																																																																					
	Rings																																																																					
Top:	2.0	Ø : 34.0 Length: 73.0																																																																				
2nd:	1.5																																																																					
oil:	3.0																																																																					
Reference no.:	Reference no.:	Reference no.:	Reference no.:																																																																			
13011-30020/21/22		13011-30040/50																																																																				
13011-30051		13013-30020/21/22																																																																				
13013-30020/21/22		13013-30051																																																																				
13014-30020/21/22		13014-30051																																																																				
13015-30020/21/22		13015-30051																																																																				
																																																																						
NM-Motorservice Article no./ Artikelnummer/ Modelo número/ статья номер	NM-Motorservice Article no.:	NM-Motorservice Article no.:	NM-Motorservice Article no.:	NM-Motorservice Article no.:	NM-Motorservice Article no.:	NM-Motorservice Article no.:																																																																
	LBS 49000 PB LBS 49000 SB	LB 49000 P LB 49000 S	KBS 49000 B	KB 49000 B	KR 49000	PB 49000																																																																

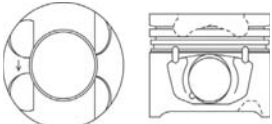

ENGINE TYPE Motortyp/ tipo de motor/ тип двигателя	LINER KIT Liner Kit/ camisas de los cilindros/ Лайнер комплект	CYL. LINER Zylinderlaufbuchse/ camisas de los cilindros/ втулка цилиндра		PISTON + RINGS Kolben + Ringe/ Pistón + Anillos/ поршень и кольца		PISTON SET Kolben Set/ Pistón Set/ поршневой	RINGS SET Ring Set/ Anillos Set/ кольца	PIN Pin/ Perno/ Пин	
1KD-FTV New LAND CRUISER (KDJ12) 2004-2006 2,982 cc 4 cyl 96.0 mm Bore Ø			Flanged	No flange	Piston		Alfin and with oil gallery skirt MOS2 treated	Rings	
		Length:	170.0	170.0	Length:	78.5		Top: 2.0 2nd: 1.5 oil: 3.0	Ø: 34.0 Length: 73.0
		Outside Ø:	99.0	99.0	Comp. height:	49.65			
		Flange Ø:	105.0						
		Flange depth:	5.0						
		Reference no.:		Reference no.:		Reference no.:	Reference no.:		
						13101-30060 13103-30060 13104-30060 13105-30060	13011-30020/21/22 13011-30040/50 13011-30051 13013-30020/21/22 13013-30051 13014-30020/21/22 13014-30051 13015-30020/21/22 13015-30051		
		Reference no.:		Reference no.:		Reference no.:	Reference no.:		
							90999-73143 90999-73156		
NM-Motorservice Article no./ Artikelnummer/ Modelo número/ статья номер	NM-Motorservice Article no.:	NM-Motorservice Article no.:		NM-Motorservice Article no.:		NM-Motorservice Article no.:	NM-Motorservice Article no.:	NM-Motorservice Article no.:	
	LBS 49001 PB LBS 49001 SB	LB 49001 P LB 49001 S		KBS 49001 B		KB 49001 B	KR 49001	PB 49001	

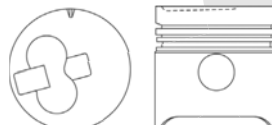

ENGINE TYPE Motortyp/ tipo de motor/ тип двигателя	LINER KIT Liner Kit/ camisas de los cilindros/ Лайнер комплект	CYL. LINER Zylinderlaufbuchse/ camisas de los cilindros/ втулка цилиндра		PISTON + RINGS Kolben + Ringe/ Pistón + Anillos/ поршень и кольца		PISTON SET Kolben Set/ Pistón Set/ поршневой	RINGS SET Ring Set/ Anillos Set/ кольца	PIN Pin/ Perno/ Пин	
1KD-FTV 2,982 cc 4 cyl 96.0 mm Bore Ø			Flanged	No flange	Piston		Alfin and with oil gallery head anodized skirt MOS2 treated	Rings	
		Length:	170.0	170.0	Length:	77.6		Top: 2.0 2nd: 1.5 oil: 3.0	Ø: 34.0 Length: 73.0
		Outside Ø:	99.0	99.0	Comp. height:	49.6			
		Flange Ø:	105.0						
		Flange depth:	5.0						
		Reference no.:		Reference no.:		Reference no.:	Reference no.:		
							13011-30020/21/22 13011-30040/50 13011-30051 13013-30020/21/22 13013-30051 13014-30020/21/22 13014-30051 13015-30020/21/22 13015-30051		
		Reference no.:		Reference no.:		Reference no.:	Reference no.:		
							90999-73143 90999-73156		
NM-Motorservice Article no./ Artikelnummer/ Modelo número/ статья номер	NM-Motorservice Article no.:	NM-Motorservice Article no.:		NM-Motorservice Article no.:		NM-Motorservice Article no.:	NM-Motorservice Article no.:	NM-Motorservice Article no.:	
	LBS 37350 PB LBS 37350 SB	LB 37350 P LB 37350 S		KBS 37350 B		KB 37350 B	KR 37350	PB 37350	



ENGINE TYPE Motortyp/ tipo de motor/ тип двигателя	LINER KIT Liner Kit/ camisas de los cilindros/ Лайнер комплект	CYL. LINER Zylinderlaufbuchse/ camisas de los cilindros/ втулка цилиндра		PISTON + RINGS Kolben + Ringe/ Pistón + Anillos/ поршень и кольца		PISTON SET Kolben Set/ Pistón Set/ поршневой	RINGS SET Ring Set/ Anillos Set/ кольца	PIN Pin/ Perno/ Пин	
1KD-FTV DYNA 150 (KDY221/231/251/261) 2006-2009 2,982 cc 4 cyl 96.0 mm Bore Ø			Flanged	No flange	Piston		Alfin and with oil gallery skirt MOS2 treated	Rings	
		Length:	170.0	170.0	Length:	78.5		Top: 2.0 2nd: 1.5 oil: 3.0	Ø: 34.0 Length: 73.0
		Outside Ø:	99.0	99.0	Comp. height:	49.6			
		Flange Ø:	105.0						
		Flange depth:	5.0						
		Reference no.:		Reference no.:		Reference no.:	Reference no.:		
						13101-30110	13011-30020/21/22 13011-30040/50 13011-30051 13013-30020/21/22 13013-30051 13014-30020/21/22 13014-30051 13015-30020/21/22 13015-30051		
		Reference no.:		Reference no.:		Reference no.:	Reference no.:		
							90999-73143 90999-73156		
NM-Motorservice Article no./ Artikelnummer/ Modelo número/ статья номер	NM-Motorservice Article no.:	NM-Motorservice Article no.:		NM-Motorservice Article no.:		NM-Motorservice Article no.:	NM-Motorservice Article no.:	NM-Motorservice Article no.:	
	LBS 37400 PB LBS 37400 SB	LB 37400 P LB 37400 S		KBS 37400 B		KB 37400 B	KR 37400	PB 37400	

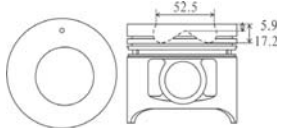

ENGINE TYPE Motortyp/ tipo de motor/ тип двигателя	LINER KIT Liner Kit/ camisas de los cilindros/ Лайнер комплект	CYL. LINER Zylinderlaufbuchse/ camisas de los cilindros/ втулка цилиндра		PISTON + RINGS Kolben + Ringe/ Pistón + Anillos/ поршень и кольца		PISTON SET Kolben Set/ Pistón Set/ поршневой	RINGS SET Ring Set/ Anillos Set/ кольца		PIN Pin/ Perno/ Пин
1KD-FTV HILUX 2,982 cc 4 cyl 96.0 mm Bore Ø			Flanged	No flange	Piston		Alfin and with oil gallery		Rings Top: Ø : 2nd: Length: oil: 2.5
		Length: 170.0 Outside Ø: 99.0 Flange Ø: 105.0 Flange depth: 5.0	170.0 99.0	Length: 101.2 Comp. height: 52.2 -2.6 -3.4					
		Reference no.:		Reference no.:		Reference no.:	Reference no.:		Reference no.:
						13101-30150 13103-30150 13104-30150 13105-30150	13011-30150 13013-30150 13014-30150 13015-30150		90999-73143 90999-73156
NM-Motorservice Article no./ Artikelnummer/ Modelo número/ статья номер	NM-Motorservice Article no.:	NM-Motorservice Article no.:		NM-Motorservice Article no.:		NM-Motorservice Article no.:	NM-Motorservice Article no.:		NM-Motorservice Article no.:
	LBS 37450 APB LBS 37450 ASB	LB 37450 P LB 37450 S		KBS 37450 AB		KB 37450 AB	KR 37450		PB 37450

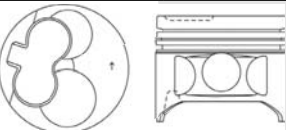

ENGINE TYPE Motortyp/ tipo de motor/ тип двигателя	LINER KIT Liner Kit/ camisas de los cilindros/ Лайнер комплект	CYL. LINER Zylinderlaufbuchse/ camisas de los cilindros/ втулка цилиндра		PISTON + RINGS Kolben + Ringe/ Pistón + Anillos/ поршень и кольца		PISTON SET Kolben Set/ Pistón Set/ поршневой	RINGS SET Ring Set/ Anillos Set/ кольца		PIN Pin/ Perno/ Пин
2B DYNA (BU31) 1981-1982 3,168 cc 4 cyl 98.0 mm Bore Ø			Liner/ Sleeve		Piston		Rings		Ø : 29.0 Length: 79.0
		Length: 190.0 Outside Ø: 102.0 Flange Ø: 107.6 Flange depth: 2.5 +1.0		Length: 101.2 Comp. height: 52.2 -2.6 -3.4			Top: 2.5 2nd: 2.5 oil: 4.5		
		Reference no.:		Reference no.:		Reference no.:	Reference no.:		Reference no.:
		11461-57010				13101-57011 13101-57020 13101-57022	13011-57010		90999-73065 90999-73121 90999-73131
NM-Motorservice Article no./ Artikelnummer/ Modelo número/ статья номер	NM-Motorservice Article no.:	NM-Motorservice Article no.:		NM-Motorservice Article no.:		NM-Motorservice Article no.:	NM-Motorservice Article no.:		NM-Motorservice Article no.:
	LBS 44850 F LBS 44850 S	LB 44850 F LB 44850 S		KBS 44850		KB 44850	KR 44850		PB 44850

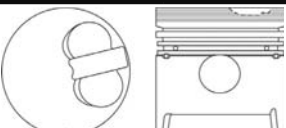

ENGINE TYPE Motortyp/ tipo de motor/ тип двигателя	LINER KIT Liner Kit/ camisas de los cilindros/ Лайнер комплект	CYL. LINER Zylinderlaufbuchse/ camisas de los cilindros/ втулка цилиндра		PISTON + RINGS Kolben + Ringe/ Pistón + Anillos/ поршень и кольца		PISTON SET Kolben Set/ Pistón Set/ поршневой	RINGS SET Ring Set/ Anillos Set/ кольца		PIN Pin/ Perno/ Пин
2Z 3,469 cc 4 cyl 98.0 mm Bore Ø			Liner/ Sleeve		Piston		Rings		Ø : 32.0 Length: 77.0
		Length: 181.5 Outside Ø: 101.0 Flange Ø: 107.0 Flange depth: 5.0		Length: 87.9 Comp. height: 50.0 -8.4 -15.7			Top: 2.0 2nd: 2.0 oil: 4.0		
		Reference no.:		Reference no.:		Reference no.:	Reference no.:		Reference no.:
		11461-78400 11461-78700				13101-78700	13011-78700 13011-78701 13011-78760		90384-32950 90384-32951
NM-Motorservice Article no./ Artikelnummer/ Modelo número/ статья номер	NM-Motorservice Article no.:	NM-Motorservice Article no.:		NM-Motorservice Article no.:		NM-Motorservice Article no.:	NM-Motorservice Article no.:		NM-Motorservice Article no.:
	LBS 37550 FA LBS 37550 SA	LB 37550 F LB 37550 S		KBS 37550 A		KB 37550 A	KR 37550		PB 37550

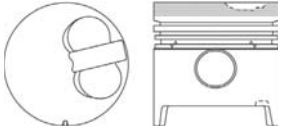

ENGINE TYPE Motortyp/ tipo de motor/ тип двигателя	LINER KIT Liner Kit/ camisas de los cilindros/ Лайнер комплект	CYL. LINER Zylinderlaufbuchse/ camisas de los cilindros/ втулка цилиндра		PISTON + RINGS Kolben + Ringe/ Pistón + Anillos/ поршень и кольца	PISTON SET Kolben Set/ Pistón Set/ поршневой	RINGS SET Ring Set/ Anillos Set/ кольца	PIN Pin/ Perno/ Пин
2Z New 3,469 cc 4 cyl 98.0 mm Bore Ø			Flanged	No flange	Piston	Rings	Ø : 32.0 Length: 77.0
		Length: 181.5 Outside Ø: 101.0 Flange Ø: 107.0 Flange depth: 5.0					
		Reference no.:		Reference no.:	Reference no.:	Reference no.:	Reference no.:
		11461-78400 11461-78700			13101-78702	13011-78700 13011-78701 13011-78760	90384-32950 90384-32951
NM-Motorservice Article no./ Artikelnummer/ Modelo número/ статья номер	NM-Motorservice Article no.:	NM-Motorservice Article no.:		NM-Motorservice Article no.:	NM-Motorservice Article no.:	NM-Motorservice Article no.:	NM-Motorservice Article no.:
	LBS 37600 LBS 37600	LB 37600 F LB 37600 S		KBS 37600	KB 37600	KR 37600	PB 37600

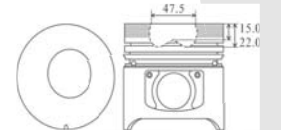

ENGINE TYPE Motortyp/ tipo de motor/ тип двигателя	LINER KIT Liner Kit/ camisas de los cilindros/ Лайнер комплект	CYL. LINER Zylinderlaufbuchse/ camisas de los cilindros/ втулка цилиндра		PISTON + RINGS Kolben + Ringe/ Pistón + Anillos/ поршень и кольца	PISTON SET Kolben Set/ Pistón Set/ поршневой	RINGS SET Ring Set/ Anillos Set/ кольца	PIN Pin/ Perno/ Пин
5L / 5L-E COMUTER • DYNA 150 • HIACE VAN (LH154/162/166/172/174/184 • LY212/ 220/230/235) 1998- 2,986 cc 4 cyl 99.5 mm Bore Ø			Flanged	No flange	Piston	Rings	Ø : 29.0 Length: 73.9
		Length: 155.0 Outside Ø: 103.5 Flange Ø: 106.5 Flange depth: 4.0	155.0	103.5			
		Reference no.:		Reference no.:	Reference no.:	Reference no.:	Reference no.:
		11461-54120			13101-54120 13103-54120	13011-54130 13013-54130	90999-73115
NM-Motorservice Article no./ Artikelnummer/ Modelo número/ статья номер	NM-Motorservice Article no.:	NM-Motorservice Article no.:		NM-Motorservice Article no.:	NM-Motorservice Article no.:	NM-Motorservice Article no.:	NM-Motorservice Article no.:
	LBS 37650 PB LBS 37650 SB	LB 37650 S LB 37650 P		KBS 37650 B	KB 37650 B	KR 37650	PB 37650

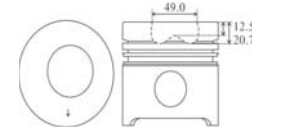

ENGINE TYPE Motortyp/ tipo de motor/ тип двигателя	LINER KIT Liner Kit/ camisas de los cilindros/ Лайнер комплект	CYL. LINER Zylinderlaufbuchse/ camisas de los cilindros/ втулка цилиндра		PISTON + RINGS Kolben + Ringe/ Pistón + Anillos/ поршень и кольца	PISTON SET Kolben Set/ Pistón Set/ поршневой	RINGS SET Ring Set/ Anillos Set/ кольца	PIN Pin/ Perno/ Пин
3B COASTER • LAND CRUISER (BB20/ 30 BJ42/45/46/60/70/73/75) 1980-1986 3,431 cc 4 cyl 102.0 mm Bore Ø			Liner/ Sleeve		Piston	Rings	Ø : 32.0 Length: 84.0
		Length: 187.5 Outside Ø: 106.0 Flange Ø: 111.7 Flange depth: 2.5 +1.0					
		Reference no.:		Reference no.:	Reference no.:	Reference no.:	Reference no.:
		11461-58010 11461-58020			13101-58011 13101-58012	13011-58010 13011-58011	90999-73088 90999-73132
NM-Motorservice Article no./ Artikelnummer/ Modelo número/ статья номер	NM-Motorservice Article no.:	NM-Motorservice Article no.:		NM-Motorservice Article no.:	NM-Motorservice Article no.:	NM-Motorservice Article no.:	NM-Motorservice Article no.:
	LBS 37700 F LBS 37700 S	LB 37700 F LB 37700 S		KBS 37700	KB 37700	KR 37700	PB 37700

ENGINE TYPE Motor/typo/ tipo de motor/ тип двигателя	LINER KIT Liner Kit/ camisas de los cilindros/ Лайнер комплект	CYL. LINER Zylinderlaufbuchse/ camisas de los cilindros/ втулка цилиндра	PISTON + RINGS Kolben + Ringe/ Pistón + Anillos/ поршень и кольца	PISTON SET Kolben Set/ Pistón Set/ поршневой	RINGS SET Ring Set/ Anillos Set/ кольца	PIN Pin/ Perno/ Пин																															
3B New DYNA 200 • LAND CRUISER (BJ70/73/ 75 • BU79/89/92/100/110/140) 1988-1995 3,431 cc 4 cyl 102.0 mm Bore Ø		<table border="1"> <tr> <td></td> <td>Liner/ Sleeve</td> <td></td> </tr> <tr> <td>Length:</td> <td>187.5</td> <td></td> </tr> <tr> <td>Outside Ø:</td> <td>106.0</td> <td></td> </tr> <tr> <td>Flange Ø:</td> <td>111.7</td> <td></td> </tr> <tr> <td>Flange depth:</td> <td>2.5 +1.0</td> <td></td> </tr> </table>		Liner/ Sleeve		Length:	187.5		Outside Ø:	106.0		Flange Ø:	111.7		Flange depth:	2.5 +1.0		<table border="1"> <tr> <td colspan="2">Piston</td> </tr> <tr> <td>Length:</td> <td>101.2</td> </tr> <tr> <td>Comp. height:</td> <td>55.2 -5.0</td> </tr> </table>	Piston		Length:	101.2	Comp. height:	55.2 -5.0		<table border="1"> <tr> <td colspan="2">Rings</td> </tr> <tr> <td>Top:</td> <td>2.5</td> </tr> <tr> <td>2nd: oil:</td> <td>2.0 4.0</td> </tr> <tr> <td>Ø:</td> <td>32.0</td> </tr> <tr> <td>Length:</td> <td>72.0</td> </tr> </table>	Rings		Top:	2.5	2nd: oil:	2.0 4.0	Ø:	32.0	Length:	72.0	
			Liner/ Sleeve																																		
		Length:	187.5																																		
Outside Ø:	106.0																																				
Flange Ø:	111.7																																				
Flange depth:	2.5 +1.0																																				
Piston																																					
Length:	101.2																																				
Comp. height:	55.2 -5.0																																				
Rings																																					
Top:	2.5																																				
2nd: oil:	2.0 4.0																																				
Ø:	32.0																																				
Length:	72.0																																				
	Reference no.:	Reference no.:	Reference no.:	Reference no.:	Reference no.:																																
	11461-58010 11461-58020		13101-58050 13103-58050 13104-58050 13105-58050	13011-58050 13011-58051 13011-58070 13013-58050/70 13014-58050/70 13015-58050/70	90999-73116 90999-73124																																
NM-Motorservice Article no./ Artikelnummer/ Modelo número/ статья номер	NM-Motorservice Article no.:	NM-Motorservice Article no.:	NM-Motorservice Article no.:	NM-Motorservice Article no.:	NM-Motorservice Article no.:	NM-Motorservice Article no.:																															
	LBS 37750 FA LBS 37750 SA	LB 37750 F LB 37750 S	KBS 37750 A	KB 37750 A	KR 37750	PB 37750																															

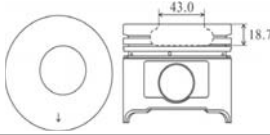

ENGINE TYPE Motor/typo/ tipo de motor/ тип двигателя	LINER KIT Liner Kit/ camisas de los cilindros/ Лайнер комплект	CYL. LINER Zylinderlaufbuchse/ camisas de los cilindros/ втулка цилиндра	PISTON + RINGS Kolben + Ringe/ Pistón + Anillos/ поршень и кольца	PISTON SET Kolben Set/ Pistón Set/ поршневой	RINGS SET Ring Set/ Anillos Set/ кольца	PIN Pin/ Perno/ Пин																															
13B 3,431 cc 4 cyl 102.0 mm Bore Ø		<table border="1"> <tr> <td></td> <td>Liner/ Sleeve</td> <td></td> </tr> <tr> <td>Length:</td> <td>187.5</td> <td></td> </tr> <tr> <td>Outside Ø:</td> <td>106.0</td> <td></td> </tr> <tr> <td>Flange Ø:</td> <td>111.7</td> <td></td> </tr> <tr> <td>Flange depth:</td> <td>2.5 +1.0</td> <td></td> </tr> </table>		Liner/ Sleeve		Length:	187.5		Outside Ø:	106.0		Flange Ø:	111.7		Flange depth:	2.5 +1.0		<table border="1"> <tr> <td colspan="2">Piston</td> </tr> <tr> <td>Length:</td> <td>104.4</td> </tr> <tr> <td>Comp. height:</td> <td>63.5 -15.0 -22.0</td> </tr> </table>	Piston		Length:	104.4	Comp. height:	63.5 -15.0 -22.0		<table border="1"> <tr> <td colspan="2">Rings</td> </tr> <tr> <td>Top:</td> <td>2.5</td> </tr> <tr> <td>2nd: oil:</td> <td>2.5 4.5</td> </tr> <tr> <td>Ø:</td> <td>34.0</td> </tr> <tr> <td>Length:</td> <td>84.0</td> </tr> </table>	Rings		Top:	2.5	2nd: oil:	2.5 4.5	Ø:	34.0	Length:	84.0	
			Liner/ Sleeve																																		
		Length:	187.5																																		
Outside Ø:	106.0																																				
Flange Ø:	111.7																																				
Flange depth:	2.5 +1.0																																				
Piston																																					
Length:	104.4																																				
Comp. height:	63.5 -15.0 -22.0																																				
Rings																																					
Top:	2.5																																				
2nd: oil:	2.5 4.5																																				
Ø:	34.0																																				
Length:	84.0																																				
	Reference no.:	Reference no.:	Reference no.:	Reference no.:	Reference no.:																																
	11461-58010 11461-58020		13101-58020 13101-58021	13011-58030	90999-73099																																
NM-Motorservice Article no./ Artikelnummer/ Modelo número/ статья номер	NM-Motorservice Article no.:	NM-Motorservice Article no.:	NM-Motorservice Article no.:	NM-Motorservice Article no.:	NM-Motorservice Article no.:	NM-Motorservice Article no.:																															
	LBS 37800 FA LBS 37800 SA	LB 37800 F LB 37800 S	KBS 37800	KB 37800	KR 37800	PB 37800																															

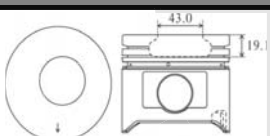

ENGINE TYPE Motor/typo/ tipo de motor/ тип двигателя	LINER KIT Liner Kit/ camisas de los cilindros/ Лайнер комплект	CYL. LINER Zylinderlaufbuchse/ camisas de los cilindros/ втулка цилиндра	PISTON + RINGS Kolben + Ringe/ Pistón + Anillos/ поршень и кольца	PISTON SET Kolben Set/ Pistón Set/ поршневой	RINGS SET Ring Set/ Anillos Set/ кольца	PIN Pin/ Perno/ Пин																															
13BT LAND CRUISER (BJ71) 1985-1990 3,431 cc 4 cyl 102.0 mm Bore Ø		<table border="1"> <tr> <td></td> <td>Liner/ Sleeve</td> <td></td> </tr> <tr> <td>Length:</td> <td>187.5</td> <td></td> </tr> <tr> <td>Outside Ø:</td> <td>106.0</td> <td></td> </tr> <tr> <td>Flange Ø:</td> <td>111.7</td> <td></td> </tr> <tr> <td>Flange depth:</td> <td>2.5 +1.0</td> <td></td> </tr> </table>		Liner/ Sleeve		Length:	187.5		Outside Ø:	106.0		Flange Ø:	111.7		Flange depth:	2.5 +1.0		<table border="1"> <tr> <td colspan="2">Piston</td> </tr> <tr> <td>Length:</td> <td>98.4</td> </tr> <tr> <td>Comp. height:</td> <td>63.5 -12.5 -20.7</td> </tr> </table>	Piston		Length:	98.4	Comp. height:	63.5 -12.5 -20.7		<table border="1"> <tr> <td colspan="2">Rings</td> </tr> <tr> <td>Top:</td> <td>2.5</td> </tr> <tr> <td>2nd: oil:</td> <td>2.5 4.5</td> </tr> <tr> <td>Ø:</td> <td>34.0</td> </tr> <tr> <td>Length:</td> <td>79.0</td> </tr> </table>	Rings		Top:	2.5	2nd: oil:	2.5 4.5	Ø:	34.0	Length:	79.0	
			Liner/ Sleeve																																		
		Length:	187.5																																		
Outside Ø:	106.0																																				
Flange Ø:	111.7																																				
Flange depth:	2.5 +1.0																																				
Piston																																					
Length:	98.4																																				
Comp. height:	63.5 -12.5 -20.7																																				
Rings																																					
Top:	2.5																																				
2nd: oil:	2.5 4.5																																				
Ø:	34.0																																				
Length:	79.0																																				
	Reference no.:	Reference no.:	Reference no.:	Reference no.:	Reference no.:																																
	11461-58010 11461-58020		13101-58030	13011-58040	90999-73100																																
NM-Motorservice Article no./ Artikelnummer/ Modelo número/ статья номер	NM-Motorservice Article no.:	NM-Motorservice Article no.:	NM-Motorservice Article no.:	NM-Motorservice Article no.:	NM-Motorservice Article no.:	NM-Motorservice Article no.:																															
	LBS 37850 FA LBS 37850 SA	LB 37850 F LB 37850 S	KBS 37850 A	KB 37850 A	KR 37850	PB 37850																															

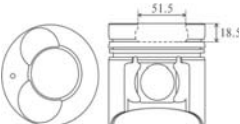

ENGINE TYPE Motortyp/ tipo de motor/ тип двигателя	LINER KIT Liner Kit/ camisas de los cilindros/ Лайнер комплект	CYL. LINER Zylinderlaufbuchse/ camisas de los cilindros/ втулка цилиндра	PISTON + RINGS Kolben + Ringe/ Pistón + Anillos/ поршень и кольца	PISTON SET Kolben Set/ Pistón Set/ поршневой	RINGS SET Ring Set/ Anillos Set/ кольца	PIN Pin/ Perno/ Пин																																																																																																																																																								
14B DYNA 200 (BU88/96/101/102/111/112/ 141/211/221) 1988-1996 3,659 cc 4 cyl 102.0 mm Bore Ø		<table border="1"> <tr> <td></td> <td>Flanged</td> <td>No flange</td> <td rowspan="2">Piston</td> </tr> <tr> <td>Length:</td> <td>187.5</td> <td>197.0</td> </tr> <tr> <td>Outside Ø:</td> <td>106.0</td> <td>106.0</td> <td>Length:</td> <td>86.9</td> </tr> <tr> <td>Flange Ø:</td> <td>111.7</td> <td></td> <td>Comp. height:</td> <td>51.8</td> </tr> <tr> <td>Flange depth:</td> <td>2.5</td> <td></td> <td></td> <td>-18.7</td> </tr> <tr> <td></td> <td>+1.0</td> <td></td> <td></td> <td></td> </tr> </table>		Flanged	No flange	Piston	Length:	187.5	197.0	Outside Ø:	106.0	106.0	Length:	86.9	Flange Ø:	111.7		Comp. height:	51.8	Flange depth:	2.5			-18.7		+1.0				<table border="1"> <tr> <td>Reference no.:</td> <td>Reference no.:</td> <td>Reference no.:</td> <td>Reference no.:</td> <td>Reference no.:</td> </tr> <tr> <td>11461-58010</td> <td></td> <td>13101-58040</td> <td>13011-58050</td> <td>90999-73116</td> </tr> <tr> <td>11461-58020</td> <td></td> <td>13101-58041</td> <td>13011-58051</td> <td>90999-73124</td> </tr> <tr> <td>11461-58040</td> <td></td> <td>13103-58040</td> <td>13011-58070</td> <td></td> </tr> <tr> <td></td> <td></td> <td>13104-58040</td> <td>13013-58050/70</td> <td></td> </tr> <tr> <td></td> <td></td> <td>13105-58040</td> <td>13014-58050/70</td> <td></td> </tr> <tr> <td></td> <td></td> <td></td> <td>13015-58050/70</td> <td></td> </tr> </table>	Reference no.:	Reference no.:	Reference no.:	Reference no.:	Reference no.:	11461-58010		13101-58040	13011-58050	90999-73116	11461-58020		13101-58041	13011-58051	90999-73124	11461-58040		13103-58040	13011-58070				13104-58040	13013-58050/70				13105-58040	13014-58050/70					13015-58050/70		<table border="1"> <tr> <td>Reference no.:</td> <td>Reference no.:</td> <td>Reference no.:</td> <td>Reference no.:</td> <td>Reference no.:</td> </tr> <tr> <td></td> <td></td> <td></td> <td></td> <td></td> </tr> <tr> <td></td> <td></td> <td></td> <td></td> <td></td> </tr> <tr> <td></td> <td></td> <td></td> <td></td> <td></td> </tr> <tr> <td></td> <td></td> <td></td> <td></td> <td></td> </tr> <tr> <td></td> <td></td> <td></td> <td></td> <td></td> </tr> </table>	Reference no.:	Reference no.:	Reference no.:	Reference no.:	Reference no.:																										<table border="1"> <tr> <td>Reference no.:</td> <td>Reference no.:</td> <td>Reference no.:</td> <td>Reference no.:</td> <td>Reference no.:</td> </tr> <tr> <td></td> <td></td> <td></td> <td></td> <td></td> </tr> <tr> <td></td> <td></td> <td></td> <td></td> <td></td> </tr> <tr> <td></td> <td></td> <td></td> <td></td> <td></td> </tr> <tr> <td></td> <td></td> <td></td> <td></td> <td></td> </tr> <tr> <td></td> <td></td> <td></td> <td></td> <td></td> </tr> </table>	Reference no.:	Reference no.:	Reference no.:	Reference no.:	Reference no.:																										<table border="1"> <tr> <td>Reference no.:</td> <td>Reference no.:</td> <td>Reference no.:</td> <td>Reference no.:</td> <td>Reference no.:</td> </tr> <tr> <td></td> <td></td> <td></td> <td></td> <td></td> </tr> <tr> <td></td> <td></td> <td></td> <td></td> <td></td> </tr> <tr> <td></td> <td></td> <td></td> <td></td> <td></td> </tr> <tr> <td></td> <td></td> <td></td> <td></td> <td></td> </tr> <tr> <td></td> <td></td> <td></td> <td></td> <td></td> </tr> </table>	Reference no.:	Reference no.:	Reference no.:	Reference no.:	Reference no.:																									
			Flanged	No flange	Piston																																																																																																																																																									
		Length:	187.5	197.0																																																																																																																																																										
Outside Ø:	106.0	106.0	Length:	86.9																																																																																																																																																										
Flange Ø:	111.7		Comp. height:	51.8																																																																																																																																																										
Flange depth:	2.5			-18.7																																																																																																																																																										
	+1.0																																																																																																																																																													
Reference no.:	Reference no.:	Reference no.:	Reference no.:	Reference no.:																																																																																																																																																										
11461-58010		13101-58040	13011-58050	90999-73116																																																																																																																																																										
11461-58020		13101-58041	13011-58051	90999-73124																																																																																																																																																										
11461-58040		13103-58040	13011-58070																																																																																																																																																											
		13104-58040	13013-58050/70																																																																																																																																																											
		13105-58040	13014-58050/70																																																																																																																																																											
			13015-58050/70																																																																																																																																																											
Reference no.:	Reference no.:	Reference no.:	Reference no.:	Reference no.:																																																																																																																																																										
Reference no.:	Reference no.:	Reference no.:	Reference no.:	Reference no.:																																																																																																																																																										
Reference no.:	Reference no.:	Reference no.:	Reference no.:	Reference no.:																																																																																																																																																										
NM-Motorservice Article no./ Artikelnummer/ Modelo número/ статья номер	NM-Motorservice Article no.:	NM-Motorservice Article no.:	NM-Motorservice Article no.:	NM-Motorservice Article no.:	NM-Motorservice Article no.:	NM-Motorservice Article no.:																																																																																																																																																								
	LBS 37900 FA LBS 37900 SA LBS 37900 PA	LB 37900 F LB 37900 S LB 37900 P	KBS 37900 A	KB 37900 A	KR 37900	PB 37900																																																																																																																																																								

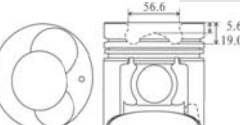

ENGINE TYPE Motortyp/ tipo de motor/ тип двигателя	LINER KIT Liner Kit/ camisas de los cilindros/ Лайнер комплект	CYL. LINER Zylinderlaufbuchse/ camisas de los cilindros/ втулка цилиндра	PISTON + RINGS Kolben + Ringe/ Pistón + Anillos/ поршень и кольца	PISTON SET Kolben Set/ Pistón Set/ поршневой	RINGS SET Ring Set/ Anillos Set/ кольца	PIN Pin/ Perno/ Пин																																																																																																										
14BT 3,659 cc 4 cyl 102.0 mm Bore Ø		<table border="1"> <tr> <td></td> <td>Flanged</td> <td>No flange</td> <td rowspan="2">Piston</td> </tr> <tr> <td>Length:</td> <td>187.5</td> <td>197.0</td> </tr> <tr> <td>Outside Ø:</td> <td>106.0</td> <td>106.0</td> <td>Length:</td> <td>94.8</td> </tr> <tr> <td>Flange Ø:</td> <td>111.7</td> <td></td> <td>Comp. height:</td> <td>59.8</td> </tr> <tr> <td>Flange depth:</td> <td>2.5</td> <td></td> <td></td> <td>-19.1</td> </tr> <tr> <td></td> <td>+1.0</td> <td></td> <td></td> <td></td> </tr> </table>		Flanged	No flange	Piston	Length:	187.5	197.0	Outside Ø:	106.0	106.0	Length:	94.8	Flange Ø:	111.7		Comp. height:	59.8	Flange depth:	2.5			-19.1		+1.0				<table border="1"> <tr> <td>Reference no.:</td> <td>Reference no.:</td> <td>Reference no.:</td> <td>Reference no.:</td> <td>Reference no.:</td> </tr> <tr> <td>11461-58010</td> <td></td> <td>13101-58060</td> <td>13011-58060</td> <td>90999-73100</td> </tr> <tr> <td>11461-58020</td> <td></td> <td></td> <td></td> <td></td> </tr> <tr> <td>11461-58040</td> <td></td> <td></td> <td></td> <td></td> </tr> </table>	Reference no.:	Reference no.:	Reference no.:	Reference no.:	Reference no.:	11461-58010		13101-58060	13011-58060	90999-73100	11461-58020					11461-58040					<table border="1"> <tr> <td>Reference no.:</td> <td>Reference no.:</td> <td>Reference no.:</td> <td>Reference no.:</td> <td>Reference no.:</td> </tr> <tr> <td></td> <td></td> <td></td> <td></td> <td></td> </tr> <tr> <td></td> <td></td> <td></td> <td></td> <td></td> </tr> <tr> <td></td> <td></td> <td></td> <td></td> <td></td> </tr> <tr> <td></td> <td></td> <td></td> <td></td> <td></td> </tr> <tr> <td></td> <td></td> <td></td> <td></td> <td></td> </tr> </table>	Reference no.:	Reference no.:	Reference no.:	Reference no.:	Reference no.:																										<table border="1"> <tr> <td>Reference no.:</td> <td>Reference no.:</td> <td>Reference no.:</td> <td>Reference no.:</td> <td>Reference no.:</td> </tr> <tr> <td></td> <td></td> <td></td> <td></td> <td></td> </tr> <tr> <td></td> <td></td> <td></td> <td></td> <td></td> </tr> <tr> <td></td> <td></td> <td></td> <td></td> <td></td> </tr> <tr> <td></td> <td></td> <td></td> <td></td> <td></td> </tr> <tr> <td></td> <td></td> <td></td> <td></td> <td></td> </tr> </table>	Reference no.:	Reference no.:	Reference no.:	Reference no.:	Reference no.:																									
			Flanged	No flange	Piston																																																																																																											
		Length:	187.5	197.0																																																																																																												
Outside Ø:	106.0	106.0	Length:	94.8																																																																																																												
Flange Ø:	111.7		Comp. height:	59.8																																																																																																												
Flange depth:	2.5			-19.1																																																																																																												
	+1.0																																																																																																															
Reference no.:	Reference no.:	Reference no.:	Reference no.:	Reference no.:																																																																																																												
11461-58010		13101-58060	13011-58060	90999-73100																																																																																																												
11461-58020																																																																																																																
11461-58040																																																																																																																
Reference no.:	Reference no.:	Reference no.:	Reference no.:	Reference no.:																																																																																																												
Reference no.:	Reference no.:	Reference no.:	Reference no.:	Reference no.:																																																																																																												
NM-Motorservice Article no./ Artikelnummer/ Modelo número/ статья номер	NM-Motorservice Article no.:	NM-Motorservice Article no.:	NM-Motorservice Article no.:	NM-Motorservice Article no.:	NM-Motorservice Article no.:	NM-Motorservice Article no.:																																																																																																										
	LBS 37950 FA LBS 37950 SA LBS 37950 PA	LB 37950 F LB 37950 S LB 37950 P	KBS 37950 A	KB 37950 A	KR 37950	PB 37950																																																																																																										

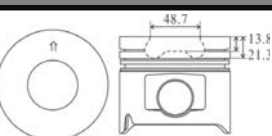

ENGINE TYPE Motortyp/ tipo de motor/ тип двигателя	LINER KIT Liner Kit/ camisas de los cilindros/ Лайнер комплект	CYL. LINER Zylinderlaufbuchse/ camisas de los cilindros/ втулка цилиндра	PISTON + RINGS Kolben + Ringe/ Pistón + Anillos/ поршень и кольца	PISTON SET Kolben Set/ Pistón Set/ поршневой	RINGS SET Ring Set/ Anillos Set/ кольца	PIN Pin/ Perno/ Пин																																																																																																					
1W DYNA (WU40/9#) 1983-1987 4,009 cc 4 cyl 104.0 mm Bore Ø	Liner OD is graded as W X and Y Z	<table border="1"> <tr> <td></td> <td>Liner Sleeve</td> <td></td> <td rowspan="2">Piston</td> </tr> <tr> <td>Length:</td> <td>201.0</td> <td></td> </tr> <tr> <td>Outside Ø:</td> <td>107.0</td> <td></td> <td>Length:</td> <td>106.2</td> </tr> <tr> <td>Flange Ø:</td> <td>112.0</td> <td></td> <td>Comp. height:</td> <td>60.2</td> </tr> <tr> <td>Flange depth:</td> <td>8.0</td> <td></td> <td></td> <td>-19.2</td> </tr> <tr> <td></td> <td>+0.9</td> <td></td> <td></td> <td></td> </tr> </table>		Liner Sleeve		Piston	Length:	201.0		Outside Ø:	107.0		Length:	106.2	Flange Ø:	112.0		Comp. height:	60.2	Flange depth:	8.0			-19.2		+0.9				<table border="1"> <tr> <td>Reference no.:</td> <td>Reference no.:</td> <td>Reference no.:</td> <td>Reference no.:</td> <td>Reference no.:</td> </tr> <tr> <td>11461-78020/30</td> <td></td> <td>13101-78020</td> <td>13011-78010</td> <td>90999-73095</td> </tr> <tr> <td>11461-78040/50</td> <td></td> <td>13101-78060</td> <td></td> <td>90999-73110</td> </tr> </table>	Reference no.:	Reference no.:	Reference no.:	Reference no.:	Reference no.:	11461-78020/30		13101-78020	13011-78010	90999-73095	11461-78040/50		13101-78060		90999-73110	<table border="1"> <tr> <td>Reference no.:</td> <td>Reference no.:</td> <td>Reference no.:</td> <td>Reference no.:</td> <td>Reference no.:</td> </tr> <tr> <td></td> <td></td> <td></td> <td></td> <td></td> </tr> <tr> <td></td> <td></td> <td></td> <td></td> <td></td> </tr> <tr> <td></td> <td></td> <td></td> <td></td> <td></td> </tr> <tr> <td></td> <td></td> <td></td> <td></td> <td></td> </tr> <tr> <td></td> <td></td> <td></td> <td></td> <td></td> </tr> </table>	Reference no.:	Reference no.:	Reference no.:	Reference no.:	Reference no.:																										<table border="1"> <tr> <td>Reference no.:</td> <td>Reference no.:</td> <td>Reference no.:</td> <td>Reference no.:</td> <td>Reference no.:</td> </tr> <tr> <td></td> <td></td> <td></td> <td></td> <td></td> </tr> <tr> <td></td> <td></td> <td></td> <td></td> <td></td> </tr> <tr> <td></td> <td></td> <td></td> <td></td> <td></td> </tr> <tr> <td></td> <td></td> <td></td> <td></td> <td></td> </tr> <tr> <td></td> <td></td> <td></td> <td></td> <td></td> </tr> </table>	Reference no.:	Reference no.:	Reference no.:	Reference no.:	Reference no.:																									
			Liner Sleeve		Piston																																																																																																						
		Length:	201.0																																																																																																								
Outside Ø:	107.0		Length:	106.2																																																																																																							
Flange Ø:	112.0		Comp. height:	60.2																																																																																																							
Flange depth:	8.0			-19.2																																																																																																							
	+0.9																																																																																																										
Reference no.:	Reference no.:	Reference no.:	Reference no.:	Reference no.:																																																																																																							
11461-78020/30		13101-78020	13011-78010	90999-73095																																																																																																							
11461-78040/50		13101-78060		90999-73110																																																																																																							
Reference no.:	Reference no.:	Reference no.:	Reference no.:	Reference no.:																																																																																																							
Reference no.:	Reference no.:	Reference no.:	Reference no.:	Reference no.:																																																																																																							
NM-Motorservice Article no./ Artikelnummer/ Modelo número/ статья номер	NM-Motorservice Article no.:	NM-Motorservice Article no.:	NM-Motorservice Article no.:	NM-Motorservice Article no.:	NM-Motorservice Article no.:	NM-Motorservice Article no.:																																																																																																					
	LBS 38000 FA	LB 38000 F (phosphated)	KBS 38000 A	KB 38000 A	KR 38000	PB 38000																																																																																																					

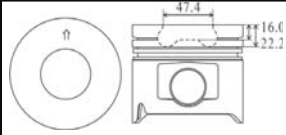

ENGINE TYPE Motor/тип de motor/ тип двигателя	LINER KIT Liner Kit/ camisas de los cilindros/ Лайнер комплект	CYL. LINER Zylinderlaufbuchse/ camisas de los cilindros/ втулка цилиндра		PISTON + RINGS Kolben + Ringe/ Pistón + Anillos/ поршень и кольца		PISTON SET Kolben Set/ Pistón Set/ поршневой		RINGS SET Ring Set/ Anillos Set/ кольца		PIN Pin/ Perno/ Пин	
W04D DYNA (WU410/420) 2002- 4,009 cc 4 cyl 104.0 mm Bore Ø	Liner OD is graded as A, B and C		Liner/ Sleeve	Piston				Rings			
		Length:	200.0	Length:	106.2	Top:	2.5	Ø:	37.0		
		Outside Ø:	107.0	Comp. height:	60.2	2nd:	2.0	Length:	85.0		
		Flange Ø:	112.0			oil:	4.0				
		Flange depth:	8.0								
		Reference no.:		Reference no.:		Reference no.:		Reference no.:		Reference no.:	
		11461-78021				13211-78120		13011-78060		13271-89102	
		11461-78031						13011-78180			
		11461-78051									
NM-Motorservice Article no./ Artikelnummer/ Modelo número/ статья номер	NM-Motorservice Article no.:	NM-Motorservice Article no.:		NM-Motorservice Article no.:		NM-Motorservice Article no.:		NM-Motorservice Article no.:		NM-Motorservice Article no.:	
	LBS 38050 FA	LB 38050 F (phosphated)		KBS 38050 A		KB 38050 A		KR 38050		PB 38050	

ENGINE TYPE Motor/тип de motor/ тип двигателя	LINER KIT Liner Kit/ camisas de los cilindros/ Лайнер комплект	CYL. LINER Zylinderlaufbuchse/ camisas de los cilindros/ втулка цилиндра		PISTON + RINGS Kolben + Ringe/ Pistón + Anillos/ поршень и кольца		PISTON SET Kolben Set/ Pistón Set/ поршневой		RINGS SET Ring Set/ Anillos Set/ кольца		PIN Pin/ Perno/ Пин	
N04C COASTER DYNA (XZB40/50# XZU413/ 415/417/423/425/427/433/435) 2006- 4,009 cc 4 cyl 104.0 mm Bore Ø	Liner OD is graded as A, B and C		Flanged	No flange	Piston				Rings		
		Length:	200.0	Length:	106.0	Top:	3.0	Ø:	37.0		
		Outside Ø:	107.0	Comp. height:	60.1	2nd:	2.0	Length:	85.0		
		Flange Ø:	112.0			oil:	4.0				
		Flange depth:	8.0								
		Reference no.:		Reference no.:		Reference no.:		Reference no.:		Reference no.:	
		11461-78021				13211-78170		13011-78190		13271-89102	
		11461-78031				13211-78190		13011-78230			
		11461-78051				13216-E0020		13011-78220			
NM-Motorservice Article no./ Artikelnummer/ Modelo número/ статья номер	NM-Motorservice Article no.:	NM-Motorservice Article no.:		NM-Motorservice Article no.:		NM-Motorservice Article no.:		NM-Motorservice Article no.:		NM-Motorservice Article no.:	
	LBS 38100 FA	LB 38100 F		KBS 38100 A		KB 38100 A		KR 38100		PB 38100	

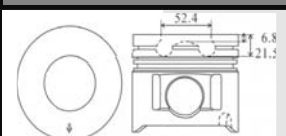
ENGINE TYPE Motor/тип de motor/ тип двигателя	LINER KIT Liner Kit/ camisas de los cilindros/ Лайнер комплект	CYL. LINER Zylinderlaufbuchse/ camisas de los cilindros/ втулка цилиндра		PISTON + RINGS Kolben + Ringe/ Pistón + Anillos/ поршень и кольца		PISTON SET Kolben Set/ Pistón Set/ поршневой		RINGS SET Ring Set/ Anillos Set/ кольца		PIN Pin/ Perno/ Пин	
15B-FT DYNA 200 (BU102/112/142/212/222) 1995- 4,104 cc 4 cyl 108.0 mm Bore Ø			Flanged	No flange	Piston				Rings		
		Length:	193.0	193.0	Length:	94.5	Top:	3.0	Ø:	34.0	
		Outside Ø:	112.0	112.0	Comp. height:	59.5	2nd:	2.0	Length:	73.0	
		Flange Ø:	115.0			oil:	4.0				
		Flange depth:	5.0								
		Reference no.:		Reference no.:		Reference no.:		Reference no.:		Reference no.:	
		11461-58090				13101-58080		13011-58090		90999-73134	
						13101-58090		13013-58090			
						13103-58080		13013-58090			
						13103-58090		13014-58090			
						13104-58080		13015-58090			
						13104-58090					
						13105-58080					
						13105-58090					
NM-Motorservice Article no./ Artikelnummer/ Modelo número/ статья номер	NM-Motorservice Article no.:	NM-Motorservice Article no.:		NM-Motorservice Article no.:		NM-Motorservice Article no.:		NM-Motorservice Article no.:		NM-Motorservice Article no.:	
	LBS 38150 PA LBS 38150 SA	LB 38150 P LB 38150 S		KBS 38150 A		KB 38150 A		KR 38150		PB 38150	

ENGINE TYPE Motortyp/ tipo de motor/ тип двигателя	LINER KIT Liner Kit/ camisas de los cilindros/ Лайнер комплект	CYL. LINER Zylinderlaufbuchse/ camisas de los cilindros/ втулка цилиндра	PISTON + RINGS Kolben + Ringe/ Pistón + Anillos/ поршень и кольца	PISTON SET Kolben Set/ Pistón Set/ поршневой	RINGS SET Ring Set/ Anillos Set/ кольца	PIN Pin/ Perno/ Пин																									
15B-FT DYNA 200 (BU102/142/212/222) 1997- 4,104 cc 4 cyl 108.0 mm Bore Ø		<table border="1"> <thead> <tr> <th></th> <th>Flanged</th> <th>No flange</th> <th colspan="2">Piston</th> </tr> </thead> <tbody> <tr> <td>Length:</td> <td>193.0</td> <td>193.0</td> <td>Length:</td> <td>94.5</td> </tr> <tr> <td>Outside Ø:</td> <td>112.0</td> <td>112.0</td> <td>Comp. height:</td> <td>59.5</td> </tr> <tr> <td>Flange Ø:</td> <td>115.0</td> <td></td> <td></td> <td>-16.0</td> </tr> <tr> <td>Flange depth:</td> <td>5.0</td> <td></td> <td></td> <td>-22.2</td> </tr> </tbody> </table>		Flanged	No flange	Piston		Length:	193.0	193.0	Length:	94.5	Outside Ø:	112.0	112.0	Comp. height:	59.5	Flange Ø:	115.0			-16.0	Flange depth:	5.0			-22.2	Alfin and with oil gallery Reference no.: 13101-58081 13101-58091 13101-58101 13103-58081 13103-58101 13104-58081 13104-58101 13105-58081 13105-58101	Rings Top: 3.0 2nd: 2.0 oil: 4.0 Ø: 34.0 Length: 73.0	Reference no.: 13011-58090 13013-58090 13014-58090 13015-58090	Reference no.: 90999-73134
			Flanged	No flange	Piston																										
		Length:	193.0	193.0	Length:	94.5																									
Outside Ø:	112.0	112.0	Comp. height:	59.5																											
Flange Ø:	115.0			-16.0																											
Flange depth:	5.0			-22.2																											
Reference no.:	Reference no.:	Reference no.:	Reference no.:																												
11461-58090																															
																															
NM-Motorservice Article no./ Artikelnummer/ Modelo número/ статья номер	NM-Motorservice Article no.:	NM-Motorservice Article no.:	NM-Motorservice Article no.:	NM-Motorservice Article no.:	NM-Motorservice Article no.:	NM-Motorservice Article no.:																									
	LBS 38200 PB LBS 38200 SB	LB 38200 P LB 38200 S	KBS 38200 B	KB 38200 B	KR 38200	PB 38200																									



ENGINE TYPE Motortyp/ tipo de motor/ тип двигателя	LINER KIT Liner Kit/ camisas de los cilindros/ Лайнер комплект	CYL. LINER Zylinderlaufbuchse/ camisas de los cilindros/ втулка цилиндра	PISTON + RINGS Kolben + Ringe/ Pistón + Anillos/ поршень и кольца	PISTON SET Kolben Set/ Pistón Set/ поршневой	RINGS SET Ring Set/ Anillos Set/ кольца	PIN Pin/ Perno/ Пин																									
15B-FTE DYNA • DYNA 200 (BU213/223/410/ 420 • XZU300/320/330/340) 1999- 4,104 cc 4 cyl 108.0 mm Bore Ø		<table border="1"> <thead> <tr> <th></th> <th>Flanged</th> <th>No flange</th> <th colspan="2">Piston</th> </tr> </thead> <tbody> <tr> <td>Length:</td> <td>193.0</td> <td>193.0</td> <td>Length:</td> <td>94.5</td> </tr> <tr> <td>Outside Ø:</td> <td>112.0</td> <td>112.0</td> <td>Comp. height:</td> <td>59.5</td> </tr> <tr> <td>Flange Ø:</td> <td>115.0</td> <td></td> <td></td> <td>-6.8</td> </tr> <tr> <td>Flange depth:</td> <td>5.0</td> <td></td> <td></td> <td>-21.5</td> </tr> </tbody> </table>		Flanged	No flange	Piston		Length:	193.0	193.0	Length:	94.5	Outside Ø:	112.0	112.0	Comp. height:	59.5	Flange Ø:	115.0			-6.8	Flange depth:	5.0			-21.5	Reference no.: 13101-58120 13103-58120 13104-58120 13105-58120	Rings Top: 3.0 2nd: 2.0 oil: 4.0 Ø: 37.0 Length: 82.0	Reference no.: 13011-58110 13013-58110 13014-58110 13015-58110	Reference no.: 90999-73141
			Flanged	No flange	Piston																										
		Length:	193.0	193.0	Length:	94.5																									
Outside Ø:	112.0	112.0	Comp. height:	59.5																											
Flange Ø:	115.0			-6.8																											
Flange depth:	5.0			-21.5																											
Reference no.:	Reference no.:	Reference no.:	Reference no.:																												
11461-58090																															
																															
NM-Motorservice Article no./ Artikelnummer/ Modelo número/ статья номер	NM-Motorservice Article no.:	NM-Motorservice Article no.:	NM-Motorservice Article no.:	NM-Motorservice Article no.:	NM-Motorservice Article no.:	NM-Motorservice Article no.:																									
	LBS 38250 PB LBS 38250 SB	LB 38250 P LB 38250 S	KBS 38250 B	KB 38250 B	KR 38250	PB 38250																									



ENGINE TYPE Motortyp/ tipo de motor/ тип двигателя	LINER KIT Liner Kit/ camisas de los cilindros/ Лайнер комплект	CYL. LINER Zylinderlaufbuchse/ camisas de los cilindros/ втулка цилиндра	PISTON + RINGS Kolben + Ringe/ Pistón + Anillos/ поршень и кольца	PISTON SET Kolben Set/ Pistón Set/ поршневой	RINGS SET Ring Set/ Anillos Set/ кольца	PIN Pin/ Perno/ Пин																				
S05C DYNA (XZU302/307/342/402/412/422) 2001-2006 4,613 cc 4 cyl 114.0 mm Bore Ø	Liner OD is graded as A, B and C	<table border="1"> <thead> <tr> <th></th> <th>Liner/ Sleeve</th> <th colspan="2">Piston</th> </tr> </thead> <tbody> <tr> <td>Length:</td> <td>186.5</td> <td>Length:</td> <td>103.5</td> </tr> <tr> <td>Outside Ø:</td> <td>117.0</td> <td>Comp. height:</td> <td>60.5</td> </tr> <tr> <td>Flange Ø:</td> <td>122.0</td> <td></td> <td>-11.0</td> </tr> <tr> <td>Flange depth:</td> <td>8.0</td> <td></td> <td>-20.0</td> </tr> </tbody> </table>		Liner/ Sleeve	Piston		Length:	186.5	Length:	103.5	Outside Ø:	117.0	Comp. height:	60.5	Flange Ø:	122.0		-11.0	Flange depth:	8.0		-20.0	Reference no.: 13216-2983 13218-78020 13218-78021	Rings Top: 2.5 2nd: 2.0 oil: 4.0 Ø: 37.0 Length: 85.0	Reference no.: 13011-78030 13011-78031	Reference no.: 13271-89101
			Liner/ Sleeve	Piston																						
		Length:	186.5	Length:	103.5																					
Outside Ø:	117.0	Comp. height:	60.5																							
Flange Ø:	122.0		-11.0																							
Flange depth:	8.0		-20.0																							
Reference no.:	Reference no.:	Reference no.:	Reference no.:																							
11461-78090 11461-78100 11461-78110																										
																										
NM-Motorservice Article no./ Artikelnummer/ Modelo número/ статья номер	NM-Motorservice Article no.:	NM-Motorservice Article no.:	NM-Motorservice Article no.:	NM-Motorservice Article no.:	NM-Motorservice Article no.:	NM-Motorservice Article no.:																				
	LBS 38300 FA	LB 38300 F (phosphated)	KBS 38300 A	KB 38300 A	KR 38300	PB 38300																				



ENGINE TYPE Motortyp/ tipo de motor/ тип двигателя	LINER KIT Liner Kit/ camisas de los cilindros/ Лайнер комплект	CYL. LINER Zylinderlaufbuchse/ camisas de los cilindros/ втулка цилиндра	PISTON + RINGS Kolben + Ringe/ Pistón + Anillos/ поршень и кольца		PISTON SET Kolben Set/ Pistón Set/ поршневой	RINGS SET Ring Set/ Anillos Set/ кольца	PIN Pin/ Perno/ Пин	
S05D DYNA (XZU4112) 2001-2002 4,899 cc 4 cyl 114.0 mm Bore Ø	Liner OD is graded as A, B and C	Liner/ Sleeve Length: 186.5 Outside Ø: 117.0 Flange Ø: 122.0 Flange depth: 8.0	Piston		Alfin and with oil gallery	Rings		Ø : Length:
			Length: Comp. height:	Length: 80.5 Comp. height: 43.5 -1.5		Top: 2.5 2nd: 2.0 oil: 4.0		
		Reference no.:	Reference no.:	Reference no.:	Reference no.:	Reference no.:	Reference no.:	
			O-Ring:					
NM-Motorservice Article no./ Artikelnummer/ Modelo número/ статья номер	NM-Motorservice Article no.:	NM-Motorservice Article no.:	NM-Motorservice Article no.:	NM-Motorservice Article no.:	NM-Motorservice Article no.:	NM-Motorservice Article no.:	NM-Motorservice Article no.:	
	LBS 38350 FB	LB 38350 F (phosphated)	KBS 38350 B	KB 38350 B	KR 38350	PB 38350		

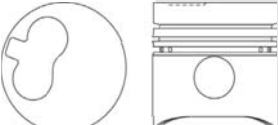

ENGINE TYPE Motortyp/ tipo de motor/ тип двигателя	LINER KIT Liner Kit/ camisas de los cilindros/ Лайнер комплект	CYL. LINER Zylinderlaufbuchse/ camisas de los cilindros/ втулка цилиндра	PISTON + RINGS Kolben + Ringe/ Pistón + Anillos/ поршень и кольца		PISTON SET Kolben Set/ Pistón Set/ поршневой	RINGS SET Ring Set/ Anillos Set/ кольца	PIN Pin/ Perno/ Пин	
1PZ LAND CRUISER (PZJ7) 1990-1993 3,469 cc 5 cyl 94.0 mm Bore Ø		Flanged Length: 168.0 Outside Ø: 98.0 Flange Ø: 113.0 Flange depth: 2.5	No flange	Piston		Rings		Ø : 29.0 Length: 65.0
			Length: 166.5 Outside Ø: 98.0	Length: 80.5 Comp. height: 43.5 -1.5	Top: 2.0 2nd: 2.0 oil: 4.0			
		Reference no.:	Reference no.:	Reference no.:	Reference no.:	Reference no.:	Reference no.:	
		11461-17010		13101-17010 13103-17010	13011-18010 13011-18030 13013-18010	90999-73126		
NM-Motorservice Article no./ Artikelnummer/ Modelo número/ статья номер	NM-Motorservice Article no.:	NM-Motorservice Article no.:	NM-Motorservice Article no.:	NM-Motorservice Article no.:	NM-Motorservice Article no.:	NM-Motorservice Article no.:	NM-Motorservice Article no.:	
	LBS 11500 PA LBS 11500 SA	LB 11500 P LB 11500 S	KBS 11500 A	KB 11500 A	KR 11500	PB 11500		

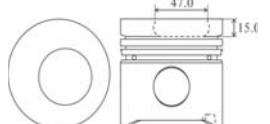

ENGINE TYPE Motortyp/ tipo de motor/ тип двигателя	LINER KIT Liner Kit/ camisas de los cilindros/ Лайнер комплект	CYL. LINER Zylinderlaufbuchse/ camisas de los cilindros/ втулка цилиндра	PISTON + RINGS Kolben + Ringe/ Pistón + Anillos/ поршень и кольца		PISTON SET Kolben Set/ Pistón Set/ поршневой	RINGS SET Ring Set/ Anillos Set/ кольца	PIN Pin/ Perno/ Пин	
H 3 Rings (L/R) DYNA • LAND CRUISER (HJ45 • HU30) 1975-1981 3,576 cc 6 cyl 88.0 mm Bore Ø		Liner/ Sleeve Length: 183.5 Outside Ø: 93.0 Flange Ø: 98.0 Flange depth: 2.5 +1.0	Piston			Rings		Ø : 27.0 Length: 74.0
			Length: 102.1 Comp. height: 52.1 -1.4 -2.8	Top: 2.5 2nd: 2.5 oil: 4.0				
		Reference no.:	Reference no.:	Reference no.:	Reference no.:	Reference no.:	Reference no.:	
		11461-47011 11461-48010 11461-48011		13081-47012/13 13085-47012/13 13101-47012/13 (L/R)	13011-47022 13011-47023 13015-47022 13015-47023	90999-70048 90999-73069 90999-73083		
NM-Motorservice Article no./ Artikelnummer/ Modelo número/ статья номер	NM-Motorservice Article no.:	NM-Motorservice Article no.:	NM-Motorservice Article no.:	NM-Motorservice Article no.:	NM-Motorservice Article no.:	NM-Motorservice Article no.:	NM-Motorservice Article no.:	
	LBS 38450 F LBS 38450	LB 38450 F LB 38450 S	KBS 38450	KB 38450	KR 38450	PB 38450		



ENGINE TYPE Motortyp/ tipo de motor/ тип двигателя	LINER KIT Liner Kit/ camisas de los cilindros/ Лайнер комплект	CYL. LINER Zylinderlaufbuchse/ camisas de los cilindros/ втулка цилиндра		PISTON + RINGS Kolben + Ringe/ Pistón + Anillos/ поршень и кольца		PISTON SET Kolben Set/ Pistón Set/ поршневой		RINGS SET Ring Set/ Anillos Set/ кольца		PIN Pin/ Perno/ Пин	
2H DYNA LAND CRUISER (HJ47/60 HU40/50) 1980-1984 3,980 cc 6 cyl 91.0 mm Bore Ø		Liner/ Sleeve		Piston				Rings			
		Length: Outside Ø: Flange Ø: Flange depth:	183.5 95.0 101.0 2.5 +1.0		Length: Comp. height:	102.2 52.1 -1.8	Top: 2nd: oil:	2.5 2.5 4.0	Ø: Length:	29.0 74.0	
		Reference no.:		Reference no.:		Reference no.:		Reference no.:		Reference no.:	
		11461-68010				13081-68010 13101-68010 13103-68010		13011-68010 13011-68020 13011-96601 13013-68020		90999-73087	
NM-Motorservice Article no./ Artikelnummer/ Modelo número/ статья номер	NM-Motorservice Article no.:	NM-Motorservice Article no.:		NM-Motorservice Article no.:		NM-Motorservice Article no.:		NM-Motorservice Article no.:		NM-Motorservice Article no.:	
	LBS 44950 F LBS 44950 S LBS 44950 FA LBS 44950 SA	LB 44950 F LB 44950 S		KBS 44950 KBS 44950 A		KB 44950 KB 44950 A		KR 44950		PB 44950	

ENGINE TYPE Motortyp/ tipo de motor/ тип двигателя	LINER KIT Liner Kit/ camisas de los cilindros/ Лайнер комплект	CYL. LINER Zylinderlaufbuchse/ camisas de los cilindros/ втулка цилиндра		PISTON + RINGS Kolben + Ringe/ Pistón + Anillos/ поршень и кольца		PISTON SET Kolben Set/ Pistón Set/ поршневой		RINGS SET Ring Set/ Anillos Set/ кольца		PIN Pin/ Perno/ Пин	
2H New LAND CRUISER (HJ47/60) 1984-1998 3,980 cc 6 cyl 91.0 mm Bore Ø		Liner/ Sleeve		Piston				Rings			
		Length: Outside Ø: Flange Ø: Flange depth:	183.5 95.0 101.0 2.5 +1.0		Length: Comp. height:	90.1 52.2 -1.6	Top: 2nd: oil:	2.5 2.5 4.0	Ø: Length:	29.0 74.0	
		Reference no.:		Reference no.:		Reference no.:		Reference no.:		Reference no.:	
		11461-68010				13011-68010 90999-73087 13011-68020 13011-96601 13013-68020		13011-68010 13011-68020 13011-96601 13013-68020		90999-73087	
NM-Motorservice Article no./ Artikelnummer/ Modelo número/ статья номер	NM-Motorservice Article no.:	NM-Motorservice Article no.:		NM-Motorservice Article no.:		NM-Motorservice Article no.:		NM-Motorservice Article no.:		NM-Motorservice Article no.:	
	LBS 38550 F LBS 38550 S	LB 38550 F LB 38550 S		KBS 38550		KB 38550		KR 38550		PB 38550	

ENGINE TYPE Motortyp/ tipo de motor/ тип двигателя	LINER KIT Liner Kit/ camisas de los cilindros/ Лайнер комплект	CYL. LINER Zylinderlaufbuchse/ camisas de los cilindros/ втулка цилиндра		PISTON + RINGS Kolben + Ringe/ Pistón + Anillos/ поршень и кольца		PISTON SET Kolben Set/ Pistón Set/ поршневой		RINGS SET Ring Set/ Anillos Set/ кольца		PIN Pin/ Perno/ Пин	
12HT LAND CRUISER (HJ61) 1985-1990 3,980 cc 6 cyl 91.0 mm Bore Ø		Liner/ Sleeve		Piston				Rings			
		Length: Outside Ø: Flange Ø: Flange depth:	183.5 95.0 101.0 2.5 +1.0		Length: Comp. height:	91.3 56.3 -15.0	Top: 2nd: oil:	2.5 2.5 4.0	Ø: Length:	32.0 77.0	
		Reference no.:		Reference no.:		Reference no.:		Reference no.:		Reference no.:	
		11461-68010				13101-68020 13103-68020		13011-68030 13013-68030		90999-73108	
NM-Motorservice Article no./ Artikelnummer/ Modelo número/ статья номер	NM-Motorservice Article no.:	NM-Motorservice Article no.:		NM-Motorservice Article no.:		NM-Motorservice Article no.:		NM-Motorservice Article no.:		NM-Motorservice Article no.:	
	LBS 38600 FA LBS 38600 SA	LB 38600 F LB 38600 S		KBS 38600 A		KB 38600 A		KR 38600		PB 38600	

ENGINE TYPE Motortyp/ tipo de motor/ тип двигателя	LINER KIT Liner Kit/ camisas de los cilindros/ Лайнер комплект	CYL. LINER Zylinderlaufbuchse/ camisas de los cilindros/ втулка цилиндра			PISTON + RINGS Kolben + Ringe/ Pistón + Anillos/ поршень и кольца		PISTON SET Kolben Set/ Pistón Set/ поршневой	RINGS SET Ring Set/ Anillos Set/ кольца		PIN Pin/ Perno/ Пин
1HZ New 4,164 cc 6 cyl 94.0 mm Bore Ø			Flanged	No flange	Piston			Rings		Ø : 29.0 Length: 65.0
		Length: 168.0 Outside Ø: 98.0 Flange Ø: 103.0 Flange depth: 2.5	168.0 98.0	Length: 80.5 Comp. height: 43.5 -1.5	Top: 2.0 2nd: 2.0 oil: 4.0					
		Reference no.:			Reference no.:	Reference no.:	Reference no.:	Reference no.:		Reference no.:
		11461-17010				13101-17100 13103-17100	13011-17010/1 13011-17020 13011-17030 13013-17010/1 13013-17020 13013-17030	90999-73126		
NM-Motorservice Article no./ Artikelnummer/ Modelo número/ статья номер	NM-Motorservice Article no.:	NM-Motorservice Article no.:			NM-Motorservice Article no.:	NM-Motorservice Article no.:	NM-Motorservice Article no.:	NM-Motorservice Article no.:		NM-Motorservice Article no.:
	LBS 38650 PA LBS 38650 SA	LB 38650 P LB 38650 S			KBS 38650 A	KB 38650 A	KR 38650	PB 38650		

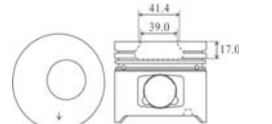
ENGINE TYPE Motortyp/ tipo de motor/ тип двигателя	LINER KIT Liner Kit/ camisas de los cilindros/ Лайнер комплект	CYL. LINER Zylinderlaufbuchse/ camisas de los cilindros/ втулка цилиндра			PISTON + RINGS Kolben + Ringe/ Pistón + Anillos/ поршень и кольца		PISTON SET Kolben Set/ Pistón Set/ поршневой	RINGS SET Ring Set/ Anillos Set/ кольца		PIN Pin/ Perno/ Пин
1HZ LAND CRUISER (HZJ7#80) 1990-2001 4,164 cc 6 cyl 94.0 mm Bore Ø			Flanged	No flange	Piston			Rings		Ø : 29.0 Length: 65.0
		Length: 168.0 Outside Ø: 98.0 Flange Ø: 103.0 Flange depth: 2.5	168.0 98.0	Length: 80.5 Comp. height: 43.5 -1.6	Top: 2.0 2nd: 2.0 oil: 4.0					
		Reference no.:			Reference no.:	Reference no.:	Reference no.:	Reference no.:		Reference no.:
		11461-17010				13101-17010 13103-17010	13011-17010/1 13011-17020 13011-17030 13013-17010/1 13013-17020 13013-17030	90999-73126		
NM-Motorservice Article no./ Artikelnummer/ Modelo número/ статья номер	NM-Motorservice Article no.:	NM-Motorservice Article no.:			NM-Motorservice Article no.:	NM-Motorservice Article no.:	NM-Motorservice Article no.:	NM-Motorservice Article no.:		NM-Motorservice Article no.:
	LBS 88500 PA LBS 88500 SA	LB 88500 P LB 88500 S			KBS 88500 A	KB 88500 A	KR 88500	PB 88500		

ENGINE TYPE Motortyp/ tipo de motor/ тип двигателя	LINER KIT Liner Kit/ camisas de los cilindros/ Лайнер комплект	CYL. LINER Zylinderlaufbuchse/ camisas de los cilindros/ втулка цилиндра			PISTON + RINGS Kolben + Ringe/ Pistón + Anillos/ поршень и кольца		PISTON SET Kolben Set/ Pistón Set/ поршневой	RINGS SET Ring Set/ Anillos Set/ кольца		PIN Pin/ Perno/ Пин
1HD-T LAND CRUISER (HDJ80) 1990-1992 4,164 cc 6 cyl 94.0 mm Bore Ø			Flanged	No flange	Piston			Rings		Ø : 33.0 Length: 73.0
		Length: 168.0 Outside Ø: 98.0 Flange Ø: 103.0 Flange depth: 2.5	168.0 98.0	Length: 80.7 Comp. height: 49.7 -17.0	Top: 2.0 2nd: 2.0 oil: 4.0					
		Reference no.:			Reference no.:	Reference no.:	Reference no.:	Reference no.:		Reference no.:
		11461-17010				13101-17020 13103-17020	13011-17010/1 13011-17020 13011-17030 13013-17010/1 13013-17020 13013-17030	90999-73127 90999-73137		
NM-Motorservice Article no./ Artikelnummer/ Modelo número/ статья номер	NM-Motorservice Article no.:	NM-Motorservice Article no.:			NM-Motorservice Article no.:	NM-Motorservice Article no.:	NM-Motorservice Article no.:	NM-Motorservice Article no.:		NM-Motorservice Article no.:
	LBS 38750 PA LBS 38750 SA	LB 38750 P LB 38750 S			KBS 38750 A	KB 38750 A	KR 38750	PB 38750		

ENGINE TYPE Motortyp/ tipo de motor/ тип двигателя	LINER KIT Liner Kit/ camisas de los cilindros/ Лайнер комплект	CYL. LINER Zylinderlaufbuchse/ camisas de los cilindros/ втулка цилиндра		PISTON + RINGS Kolben + Ringe/ Pistón + Anillos/ поршень и кольца		PISTON SET Kolben Set/ Pistón Set/ поршневой	RINGS SET Ring Set/ Anillos Set/ кольца		PIN Pin/ Perno/ Пин		
1HD-T 4,164 cc 6 cyl 94.0 mm Bore Ø			Flanged	No flange	Piston		Rings				
		Length: Outside Ø: Flange Ø: Flange depth:	168.0 98.0 103.0 2.5	168.0 98.0	Length: Comp. height:	80.7 49.7 -16.3	Top: 2nd: oil:	2.0 2.0 4.0	Ø: Length:	33.0 73.0	
		Reference no.:		Reference no.:		Reference no.:		Reference no.:		Reference no.:	
		11461-17010				13101-17040 13103-17040		13011-17010/1 13011-17020 13011-17030 13013-17010/1 13013-17020 13013-17030		90999-73127 90999-73137	
NM-Motorservice Article no./ Artikelnummer/ Modelo número/ статья номер		NM-Motorservice Article no.:		NM-Motorservice Article no.:		NM-Motorservice Article no.:		NM-Motorservice Article no.:		NM-Motorservice Article no.:	
		LBS 89500 PA LBS 89500 SA		LB 89500 P LB 89500 S		KBS 89500 A		KB 89500 A		KR 89500 PB 89500	



ENGINE TYPE Motortyp/ tipo de motor/ тип двигателя	LINER KIT Liner Kit/ camisas de los cilindros/ Лайнер комплект	CYL. LINER Zylinderlaufbuchse/ camisas de los cilindros/ втулка цилиндра		PISTON + RINGS Kolben + Ringe/ Pistón + Anillos/ поршень и кольца		PISTON SET Kolben Set/ Pistón Set/ поршневой	RINGS SET Ring Set/ Anillos Set/ кольца		PIN Pin/ Perno/ Пин		
1HD-T 4,164 cc 6 cyl 94.0 mm Bore Ø			Flanged	No flange	Piston		Rings				
		Length: Outside Ø: Flange Ø: Flange depth:	168.0 98.0 103.0 2.5	168.0 98.0	Length: Comp. height:	80.7 49.7 -17.1	Top: 2nd: oil:	2.0 2.0 4.0	Ø: Length:	33.0 73.0	
		Reference no.:		Reference no.:		Reference no.:		Reference no.:		Reference no.:	
		11461-17010				13101-17060		13011-17010/1 13011-17020 13011-17030 13013-17010/1 13013-17020 13013-17030		90999-73127 90999-73137	
NM-Motorservice Article no./ Artikelnummer/ Modelo número/ статья номер		NM-Motorservice Article no.:		NM-Motorservice Article no.:		NM-Motorservice Article no.:		NM-Motorservice Article no.:		NM-Motorservice Article no.:	
		LBS 38850 PA LBS 38850 SA		LB 38850 P LB 38850 S		KBS 38850 A		KB 38850 A		KR 38850 PB 38850	



ENGINE TYPE Motortyp/ tipo de motor/ тип двигателя	LINER KIT Liner Kit/ camisas de los cilindros/ Лайнер комплект	CYL. LINER Zylinderlaufbuchse/ camisas de los cilindros/ втулка цилиндра		PISTON + RINGS Kolben + Ringe/ Pistón + Anillos/ поршень и кольца		PISTON SET Kolben Set/ Pistón Set/ поршневой	RINGS SET Ring Set/ Anillos Set/ кольца		PIN Pin/ Perno/ Пин		
1HD-FT LAND CRUISER (HDJ80) 1995-1998 4,164 cc 6 cyl 94.0 mm Bore Ø			Flanged	No flange	Piston		Alfin and with oil gallery		Rings		
		Length: Outside Ø: Flange Ø: Flange depth:	168.0 98.0 103.0 2.5	168.0 98.0	Length: Comp. height:	80.4 49.4 -12.5 -18.5	Top: 2nd: oil:	2.0 2.0 4.0	Ø: Length:	33.0 73.0	
		Reference no.:		Reference no.:		Reference no.:		Reference no.:		Reference no.:	
		11461-17010				13101-17080 13101-17090 13101-17091 13103-17080 13103-17090		13011-17010/1 13011-17020 13011-17030 13013-17010/1 13013-17020 13013-17030		90999-73127 90999-73137	
NM-Motorservice Article no./ Artikelnummer/ Modelo número/ статья номер		NM-Motorservice Article no.:		NM-Motorservice Article no.:		NM-Motorservice Article no.:		NM-Motorservice Article no.:		NM-Motorservice Article no.:	
		LBS 90500 PB LBS 90500 SB		LB 90500 P LB 90500 S		KBS 90500 B		KB 90500 B		KR 90500 PB 90500	

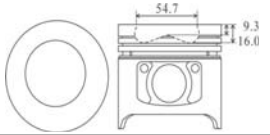

ENGINE TYPE Motor/тип de motor/ тип двигателя	LINER KIT Liner Kit/ camisas de los cilindros/ Лайнер комплект	CYL. LINER Zylinderlaufbuchse/ camisas de los cilindros/ втулка цилиндра		PISTON + RINGS Kolben + Ringe/ Pistón + Anillos/ поршень и кольца		PISTON SET Kolben Set/ Pistón Set/ поршневой	RINGS SET Ring Set/ Anillos Set/ кольца		PIN Pin/ Perno/ Пин	
1HZ LAND CRUISER (HZJ7#) 1999-2001 4,164 cc 6 cyl 94.0 mm Bore Ø			Flanged	No flange	Piston		Rings		Ø : 33.0 Length: 73.0	
		Length: 168.0 Outside Ø: 98.0 Flange Ø: 103.0 Flange depth: 2.5	168.0 98.0	Length: 80.7 Comp. height: 49.7 -1.6			Top: 2.0 2nd: 2.0 oil: 4.0	Reference no.:		
		Reference no.: 11461-17010		Reference no.:		Reference no.:		13011-17010 13011-17011 13011-17020 13011-17030 13013-17010 13013-17011 13013-17020 13013-17030		Reference no.:
NM-Motorservice Article no./ Artikelnummer/ Modelo número/ статья номер	NM-Motorservice Article no.:	NM-Motorservice Article no.:		NM-Motorservice Article no.:		NM-Motorservice Article no.:	NM-Motorservice Article no.:		NM-Motorservice Article no.:	
	LBS 38950 PA LBS 38950 SA	LB 38950 P LB 38950 S		KBS 38950 A		KB 38950 A	KR 38950		PB 38950	

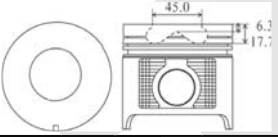

ENGINE TYPE Motor/тип de motor/ тип двигателя	LINER KIT Liner Kit/ camisas de los cilindros/ Лайнер комплект	CYL. LINER Zylinderlaufbuchse/ camisas de los cilindros/ втулка цилиндра		PISTON + RINGS Kolben + Ringe/ Pistón + Anillos/ поршень и кольца		PISTON SET Kolben Set/ Pistón Set/ поршневой	RINGS SET Ring Set/ Anillos Set/ кольца		PIN Pin/ Perno/ Пин	
1HD-FTE LAND CRUISER 100 (HDJ100) 1998- 4,164 cc 6 cyl 94.0 mm Bore Ø			Flanged	No flange	Piston		Rings		Ø : 33.0 Length: 73.0	
		Length: 168.0 Outside Ø: 98.0 Flange Ø: 103.0 Flange depth: 2.5	168.0 98.0	Length: 80.4 Comp. height: 49.4 -6.1 -18.1	Alfin and with oil gallery		Top: 2.0 2nd: 1.5 oil: 4.0	Reference no.:		
		Reference no.: 11461-17010		Reference no.:		Reference no.:		Reference no.:		Reference no.:
NM-Motorservice Article no./ Artikelnummer/ Modelo número/ статья номер	NM-Motorservice Article no.:	NM-Motorservice Article no.:		NM-Motorservice Article no.:		NM-Motorservice Article no.:	NM-Motorservice Article no.:		NM-Motorservice Article no.:	
	LBS 39000 PB LBS 39000 SB	LB 39000 P LB 39000 S		KBS 39000 B		KB 39000 B	KR 39000		PB 39000	

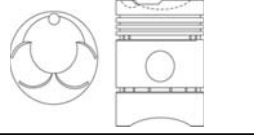

ENGINE TYPE Motor/тип de motor/ тип двигателя	LINER KIT Liner Kit/ camisas de los cilindros/ Лайнер комплект	CYL. LINER Zylinderlaufbuchse/ camisas de los cilindros/ втулка цилиндра		PISTON + RINGS Kolben + Ringe/ Pistón + Anillos/ поршень и кольца		PISTON SET Kolben Set/ Pistón Set/ поршневой	RINGS SET Ring Set/ Anillos Set/ кольца		PIN Pin/ Perno/ Пин	
11Z 4,430 cc 6 cyl 96.0 mm Bore Ø			Liner/ Sleeve	Piston		Rings		Ø : 32.0 Length: 77.0		
		Length: 182.5 Outside Ø: 100.0 Flange Ø: 105.8 Flange depth: 8.0		Length: 94.4 Comp. height: 56.5 -7.0 -15.6			Top: 2.0 2nd: 2.0 oil: 4.0		Reference no.:	
		Reference no.: 11461-78300 11461-78301 11461-78360		Reference no.:		Reference no.:			Reference no.:	
NM-Motorservice Article no./ Artikelnummer/ Modelo número/ статья номер	NM-Motorservice Article no.:	NM-Motorservice Article no.:		NM-Motorservice Article no.:		NM-Motorservice Article no.:	NM-Motorservice Article no.:		NM-Motorservice Article no.:	
	LBS 39050 F LBS 39050 S	LB 39050 F LB 39050 S		KBS 39050		KB 39050	KR 39050		PB 39050	

ENGINE TYPE Motortyp/ tipo de motor/ тип двигателя	LINER KIT Liner Kit/ camisas de los cilindros/ Лайнер комплект	CYL. LINER Zylinderlaufbuchse/ camisas de los cilindros/ втулка цилиндра	PISTON + RINGS Kolben + Ringe/ Pistón + Anillos/ поршень и кольца	PISTON SET Kolben Set/ Pistón Set/ поршневой	RINGS SET Ring Set/ Anillos Set/ кольца	PIN Pin/ Perno/ Пин	
12Z 4,994 cc 6 cyl 96.0 mm Bore Ø		Liner/ Sleeve	Piston		Rings		
		Length: Outside Ø: Flange Ø: Flange depth:	182.5 100.0 105.8 8.0	Length: Comp. height:	88.0 50.1 -9.3 -16.0	Top: 2nd: oil:	2.0 2.0 4.0
		Reference no.:	Reference no.:	Reference no.:	Reference no.:	Reference no.:	
		11461-78300 11461-78301 11461-78360		13101-78360	13011-78300	90384-32950 90384-32951	
NM-Motorservice Article no./ Artikelnummer/ Modelo número/ статья номер	NM-Motorservice Article no.:	NM-Motorservice Article no.:	NM-Motorservice Article no.:	NM-Motorservice Article no.:	NM-Motorservice Article no.:	NM-Motorservice Article no.:	
	LBS 39100 F LBS 39100 S	LB 39100 F LB 39100 S	KBS 39100	KB 39100	KR 39100	PB 39100	

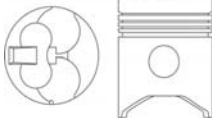
ENGINE TYPE Motortyp/ tipo de motor/ тип двигателя	LINER KIT Liner Kit/ camisas de los cilindros/ Лайнер комплект	CYL. LINER Zylinderlaufbuchse/ camisas de los cilindros/ втулка цилиндра	PISTON + RINGS Kolben + Ringe/ Pistón + Anillos/ поршень и кольца	PISTON SET Kolben Set/ Pistón Set/ поршневой	RINGS SET Ring Set/ Anillos Set/ кольца	PIN Pin/ Perno/ Пин	
13Z 5,244 cc 6 cyl 98.0 mm Bore Ø		Liner/ Sleeve	Piston		Rings		
		Length: Outside Ø: Flange Ø: Flange depth:	181.5 101.0 107.0 5.0	Length: Comp. height:	94.4 56.5 -6.3 -17.7	Top: 2nd: oil:	2.0 2.0 4.0
		Reference no.:	Reference no.:	Reference no.:	Reference no.:	Reference no.:	
NM-Motorservice Article no./ Artikelnummer/ Modelo número/ статья номер	NM-Motorservice Article no.:	NM-Motorservice Article no.:	NM-Motorservice Article no.:	NM-Motorservice Article no.:	NM-Motorservice Article no.:	NM-Motorservice Article no.:	
	LBS 39150 F LBS 39150 S LBS 39150 FA LBS 39150 SA	LB 39150 F LB 39150 S	KBS 39150 KBS 39150 A	KB 39150 KB 39150 A	KR 39150	PB 39150	

ENGINE TYPE Motortyp/ tipo de motor/ тип двигателя	LINER KIT Liner Kit/ camisas de los cilindros/ Лайнер комплект	CYL. LINER Zylinderlaufbuchse/ camisas de los cilindros/ втулка цилиндра	PISTON + RINGS Kolben + Ringe/ Pistón + Anillos/ поршень и кольца	PISTON SET Kolben Set/ Pistón Set/ поршневой	RINGS SET Ring Set/ Anillos Set/ кольца	PIN Pin/ Perno/ Пин		
2D 5 Rings 6,494 cc 6 cyl 105.0 mm Bore Ø		Flanged	No flange	Piston		Rings		
		Length: Outside Ø: Flange Ø: Flange depth:	242.0 115.5 120.0 10.0		Length: Comp. height:	138.0 73.0 -8.0 -10.0	Top: 2nd: 3rd: 1st oil: 2nd oil:	3.0 3.0 3.0 5.0 5.0
		Reference no.:	Reference no.:	Reference no.:	Reference no.:	Reference no.:		
		11461-77015 11461-77040	O-Ring: 90301-99060	13101-77012 13101-77013	13011-77010 13011-77020 13011-77021 13011-77022 13011-77023	90999-70004 90999-70005		
NM-Motorservice Article no./ Artikelnummer/ Modelo número/ статья номер	NM-Motorservice Article no.:	NM-Motorservice Article no.:	NM-Motorservice Article no.:	NM-Motorservice Article no.:	NM-Motorservice Article no.:	NM-Motorservice Article no.:		
	LBS 39200 F	LB 39200 F	KBS 39200	KB 39200	KR 39200	PB 39200		

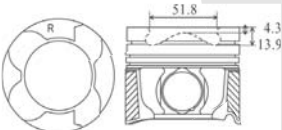
ENGINE TYPE Motortyp/ tipo de motor/ тип двигателя	LINER KIT Liner Kit/ camisas de los cilindros/ Лайнер комплект	CYL. LINER Zylinderlaufbuchse/ camisas de los cilindros/ втулка цилиндра	PISTON + RINGS Kolben + Ringe/ Pistón + Anillos/ поршень и кольца	PISTON SET Kolben Set/ Pistón Set/ поршневой	RINGS SET Ring Set/ Anillos Set/ кольца	PIN Pin/ Perno/ Пин
2D 4 Rings		Liner/ Sleeve	Piston		Rings	
6,494 cc 6 cyl 105.0 mm Bore Ø						
						
NM-Motorservice Article no./ Artikelnummer/ Modelo нúmero/ статья номер	NM-Motorservice Article no.:	NM-Motorservice Article no.:	NM-Motorservice Article no.:	NM-Motorservice Article no.:	NM-Motorservice Article no.:	NM-Motorservice Article no.:
	LBS 39250 F	LB 39250 F	KBS 39250	KB 39250	KR 39250	PB 39250
		Reference no.:	Reference no.:	Reference no.:	Reference no.:	Reference no.:
		11461-77021		13101-77020 13211-77016 13211-77020 13211-77021	13011-77040 13011-77041 13011-77050	90999-73080 90999-73081

ENGINE TYPE Motortyp/ tipo de motor/ тип двигателя	LINER KIT Liner Kit/ camisas de los cilindros/ Лайнер комплект	CYL. LINER Zylinderlaufbuchse/ camisas de los cilindros/ втулка цилиндра	PISTON + RINGS Kolben + Ringe/ Pistón + Anillos/ поршень и кольца	PISTON SET Kolben Set/ Pistón Set/ поршневой	RINGS SET Ring Set/ Anillos Set/ кольца	PIN Pin/ Perno/ Пин
1VD-FTV (L/R)		Liner/ Sleeve	Piston	Alfin and with oil gallery skirt MOS2 treated	Rings	
LAND CRUISER (VDJ200) 2007- 4,461 cc 8 cyl 86.0 mm Bore Ø						
						
NM-Motorservice Article no./ Artikelnummer/ Modelo нúmero/ статья номер	NM-Motorservice Article no.:	NM-Motorservice Article no.:	NM-Motorservice Article no.:	NM-Motorservice Article no.:	NM-Motorservice Article no.:	NM-Motorservice Article no.:
	LBS 91500 PB LBS 91500 SB	LB 91500 P LB 91500 S	KBS 91500 B	KB 91500 B	KR 91500	PB 91500
		Reference no.:	Reference no.:	Reference no.:	Reference no.:	Reference no.:
				13101-0W020 13301-0W010 (L/R)	13011-51031 13011-51040	







NOTES



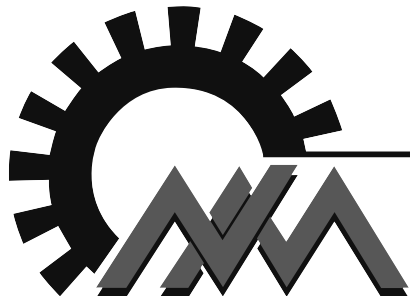

NM-Motorservice

Engine Components



Katalog überreicht durch:
Catalogue provided by:



www.NM-Motorservice.com

NM-Motorservice GmbH • Siemensstrasse 20 • 48619 Heek • Germany
Tel.: +49 (0) 2568 93 44 0 • Fax: +49 (0) 2568 93 44 11