

NM-Motorservice
Engine Components

PETROL

KOLBEN

FÜR ASIA MOTOREN

Piston & Rings
for Asian motors

• Pistón & Anillos
para los motores de Asia

• Поршень и Кольца
для Азиатских Двигателей

Edition
2013/ 2014



1

PISTON TERMINOLOGY

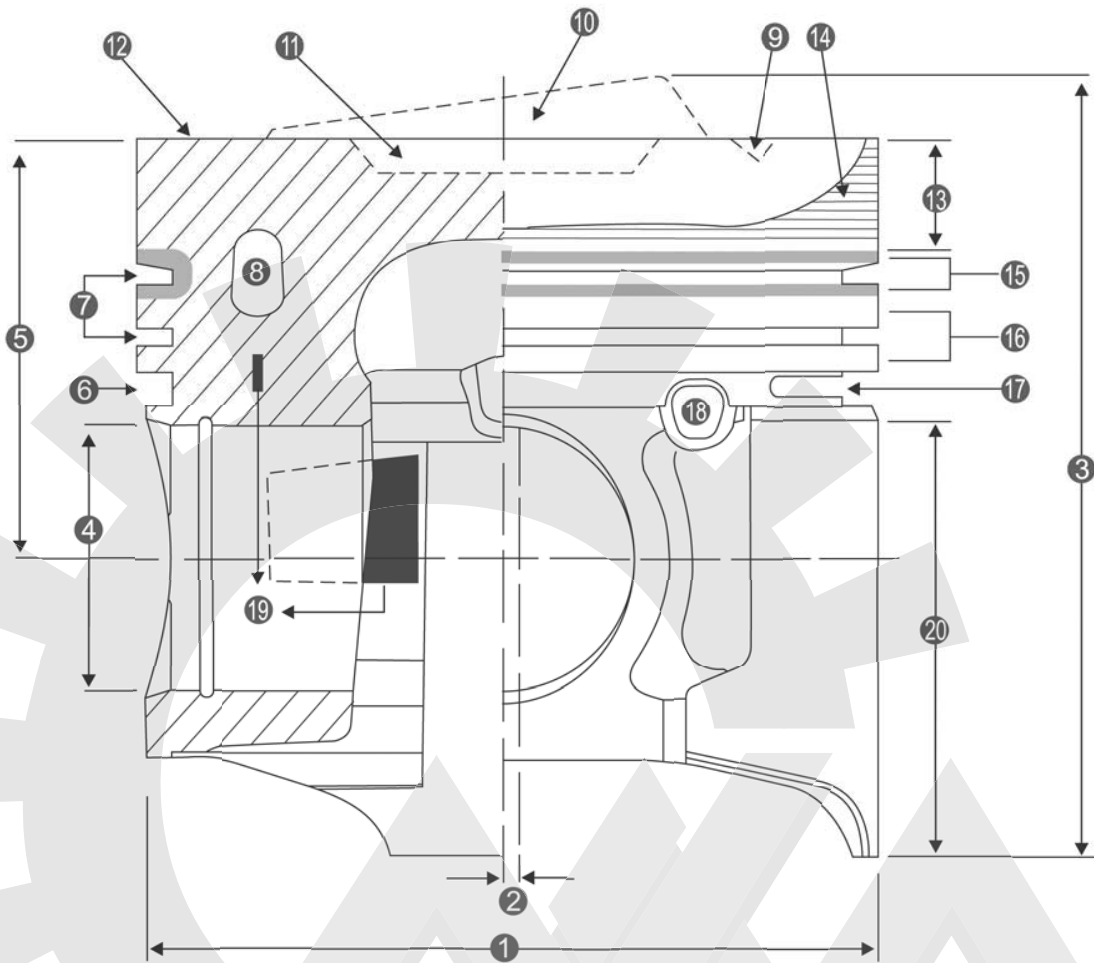

- | | |
|---|---------------------------|
| ① Piston skirt diameter | ⑪ Combustion-chamber bowl |
| ② Piston offset | ⑫ Piston crown |
| ③ Total piston length | ⑬ Top land |
| ④ Piston pin hole diameter | ⑭ Anti-scuff bands |
| ⑤ Compression height | ⑮ Alfin (Ring carrier) |
| ⑥ Oil ring groove | ⑯ Ring land |
| ⑦ Top and second compression ring grooves | ⑰ Oil slit groove |
| ⑧ Oil gallery (Oil cooling channel) | ⑱ Hidden steel struts |
| ⑨ Valve recess depth | ⑳ Skirt area |
| ⑩ Crown chamber | |

LINER / SLEEVE TERMINOLOGY

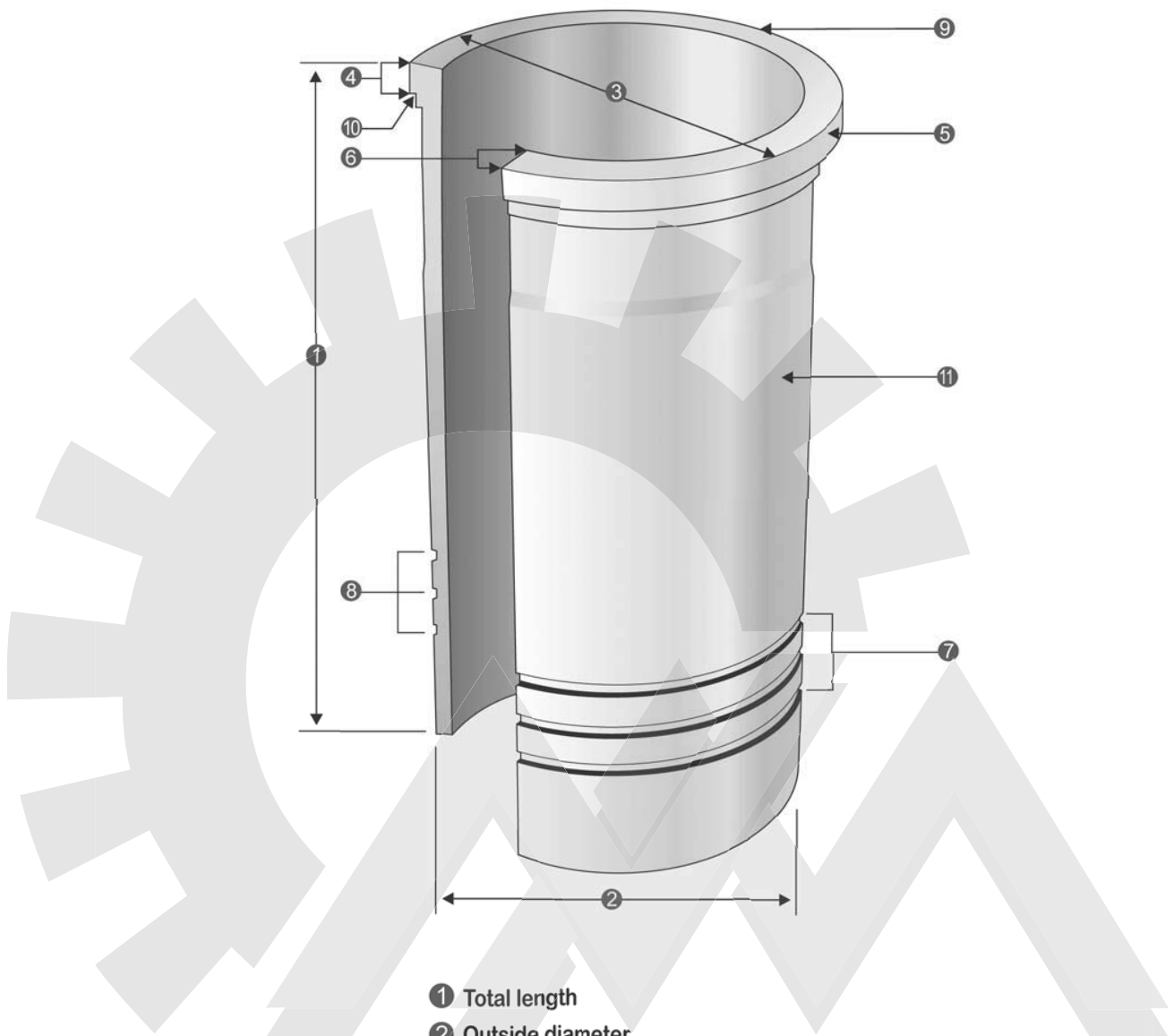

- ① Total length
- ② Outside diameter
- ③ Flange diameter (Register diameter)
- ④ Flange depth (Collar height)
- ⑤ Flange
- ⑥ Top land width
- ⑦ Sealing area
- ⑧ O-Ring groove
- ⑨ Firewall
- ⑩ Machining relief
- ⑪ Barrel

PISTON RINGS TERMINOLOGY

COMPRESSION RING

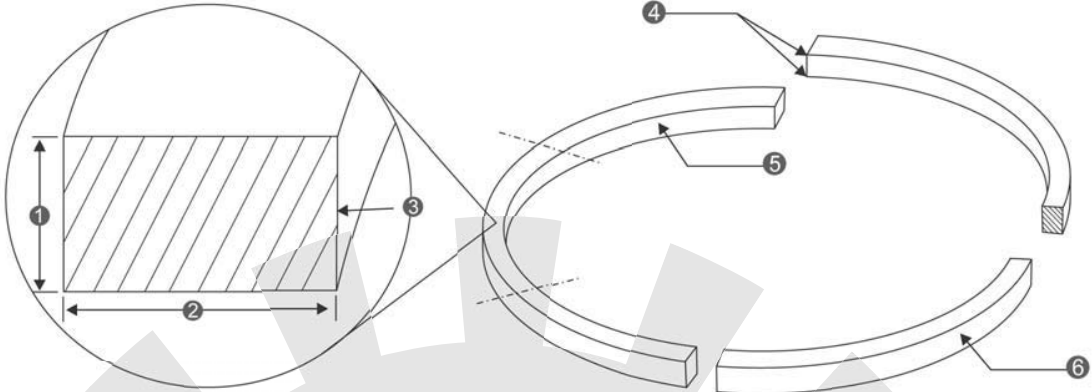

OIL CONTROL RING

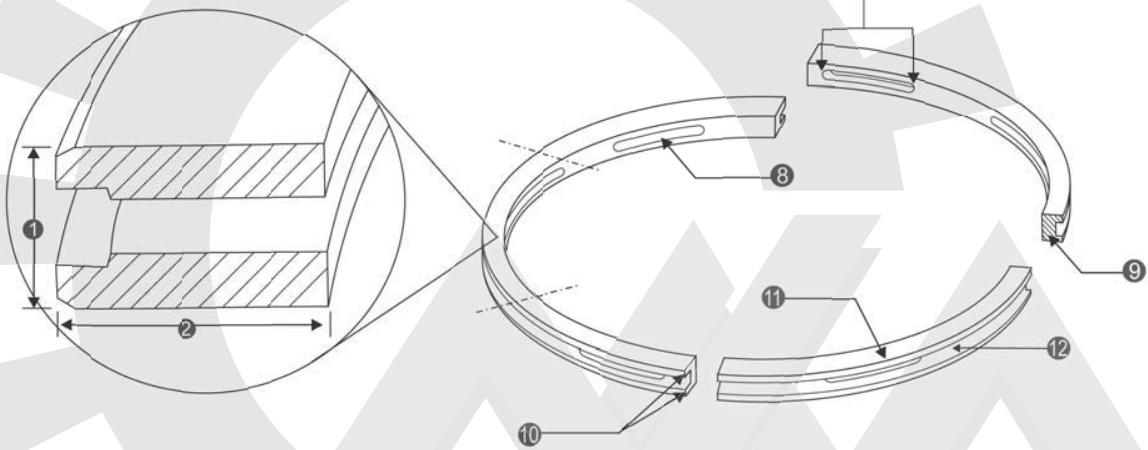

- ① Piston ring width
- ② Piston ring thickness
- ③ Inside edge of gap
- ④ Inside edges
- ⑤ Inside surface
- ⑥ Peripheral surface
- ⑦ Inside edges of slot
- ⑧ Slot face
- ⑨ Gap face
- ⑩ Outside gap corners
- ⑪ Side face
- ⑫ Outside groove face

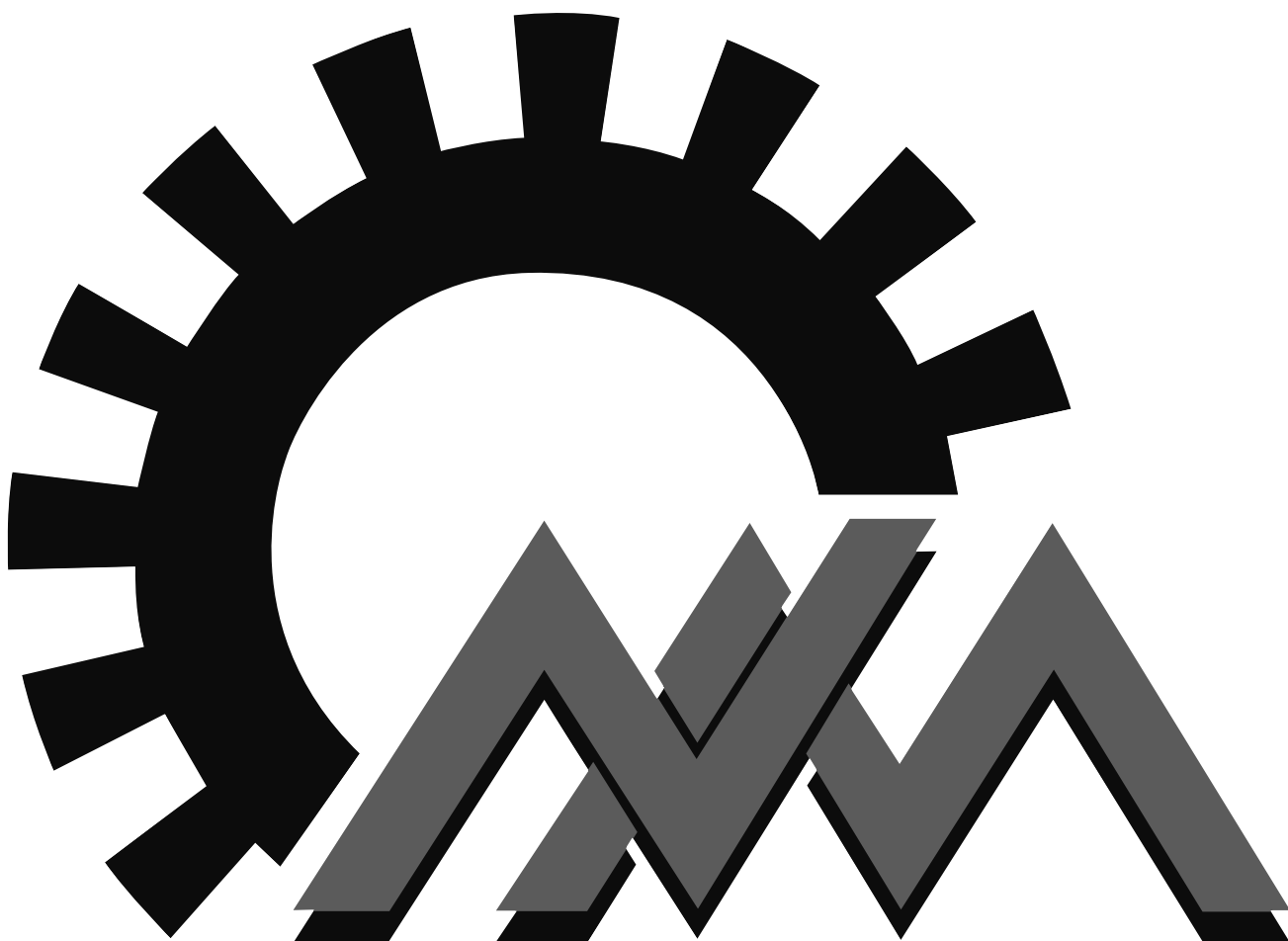

GUIDE to NM-Motorservice numbers

LBS = LINER KIT
 Liner Kit/
 camisas de los cilindros/
 Лайнер комплект
 LBS = LB + KBS

LB = CYL. LINER
 Zylinderlaufbuchse/
 camisas de los cilindros/
 втулка цилиндра

KBS = PISTON + RINGS
 Kolben + Ringe/
 Pistón + Anillos/
 поршень и кольца

KB = PISTON SET
 Kolben Set/
 Pistón Set/
 поршневой

KR = RINGS SET
 Ring Set/
 Anillos Set/
 кольца

PB = PIN
 Pin/
 Perno/
 Пин

Description of Engine and Liner/ Sleeve:

C = Chromed liner
F = Fully-finished liner
P = Semi-finished sleeve, w/ out flange
S = Semi-finished sleeve

Description of Piston:

A = Alfin
B = Alfin and with oil gallery
G = Oil gallery

Größen/ Sizes/ Tamaños/ Размеры:

Standard/ Standard/ Estándar/ Стандарт:	0,00 mm
Übergröße/ Oversize/ Grande/ Негабаритный:	
S1	0,25 mm
S2	0,50 mm
S3	0,75 mm
S4	1,00 mm



THIS IS A PARTS REFERENCE CATALOGUE ONLY. WHILST EVERY ENDEAVOR HAS BEEN MADE TO ENSURE THE ACCURACY OF THE INFORMATION, NO LIABILITY WILL BE ACCEPTED FOR ANY ERRORS OR OMISSIONS. ACCORDINGLY, CLAIMS ORIGINATING FROM INFORMATION CONTAINED IN THIS CATALOGUE CANNOT BE RECOGNIZED.

WE WOULD BE PLEASED TO RECEIVE ANY ADVICE ON ANY ERRORS OR ADDITIONS WHICH MAY COME TO YOUR ATTENTION.

SINCERELY,
 YOURS

 NM-Motorservice TEAM

NEW ITEMS IN 2012 EDITION

DAEWOO

1.5 New ∅ 76.5 mm ----- 004

DAIHATSU

ED ∅ 66.6 mm ----- 007

ED ∅ 66.6 mm ----- 008

HONDA

L15A6 ∅ 73.0 mm ----- 018

CIVIC EXI ∅ 75.0 mm ----- 028

CIVIC VTI ∅ 75.0 mm ----- 028

B18C1 ∅ 81.0 mm ----- 035

R18 ∅ 81.0 mm ----- 035

F22B1 ∅ 85.0 mm ----- 040

CB-400 ∅ 85.0 mm ----- 040

H22A ∅ 87.0 mm ----- 043

J32A ∅ 89.0 mm ----- 046

HYUNDAI

PICANTO ∅ 67.0 mm ----- 047

ISUZU

4XF1 ∅ 80.0 mm ----- 059

6VD1 ∅ 93.4 mm ----- 068

6VD1 ∅ 93.4 mm ----- 070

MAZDA

B6 ∅ 78.0 mm ----- 088

B6 ∅ 78.0 mm ----- 088

ZM ∅ 78.0 mm ----- 088

ZM ∅ 78.0 mm ----- 089

B6 ∅ 78.0 mm ----- 089

B6-ZE ∅ 78.0 mm ----- 089

MITSUBISHI

4G13 ∅ 71.0 mm ----- 112

NISSAN

A14 ∅ 76.0 mm ----- 156

HR16DE ∅ 78.0 mm ----- 158

HR16DE ∅ 78.0 mm ----- 158

SR20DE ∅ 86.0 mm ----- 173

KA24DE ∅ 89.0 mm ----- 180

TB45 ∅ 99.5 mm ----- 195

TB48DE ∅ 99.5 mm ----- 196

TOYOTA

3SZ-FE ∅ 72.0 mm ----- 222

1ZZ-FE ∅ 79.0 mm ----- 232

3ZR-FE ∅ 80.5 mm ----- 235

3ZR-FAE/3ZR-FBE ∅ 80.5 mm ----- 235

2ZR-FE ∅ 80.5 mm ----- 235

INDEX

CHANA		001	HONDA		014-046	EK1	∅ 77.0	
JL465Q1	∅ 66.0	001	N360	∅ 62.5	014	EP	∅ 77.0	030
JL474Q	∅ 74.0		TN360	∅ 62.5		ES	∅ 80.0	
			EH	∅ 72.0		ET/ET2	∅ 80.0	
			ER	∅ 66.0	015	ES	∅ 80.0	031
			EB1	∅ 70.0		ES	∅ 80.0	
DAEWOO		002-005	EN/EB3	∅ 72.0		ES	∅ 80.0	
F8C	∅ 68.5	002	EB5	∅ 72.0	016	B20A3	∅ 81.0	032
B10S	∅ 68.5		EB2	∅ 72.0		B20A5	∅ 81.0	
A15DM	∅ 76.5		EB3	∅ 72.0		B16A2	∅ 81.0	
A15MF	∅ 76.5	003	EJ	∅ 72.0	017	B18A1	∅ 81.0	033
A15MF	∅ 76.5		EJ/EB3	∅ 72.0		B18B1	∅ 81.0	
A13DM/A14DM	∅ 76.5		L13A4	∅ 73.0		B18C5	∅ 81.0	
1.5 New	∅ 76.5	004	L15A6	∅ 73.0	018	B16B	∅ 81.0	034
A16DM/A16MF	∅ 79.0		L15A6	∅ 73.0		R18A1/R18A2	∅ 81.0	
C 20 SE/X 22 SE	∅ 86.0		EW	∅ 74.0		B18C1	∅ 81.0	
2.0i	∅ 86.0	005	ED1	∅ 74.0	019	R18	∅ 81.0	035
2.0i	∅ 86.0		ED1	∅ 74.0		A20A	∅ 82.7	
			EF1/EF2	∅ 74.0		A20A	∅ 82.7	
			EW(L/R)	∅ 74.0	020	A20A	∅ 82.7	036
			D15A3/EW4	∅ 74.0		A20A/BT1	∅ 82.7	
DAIHATSU		006-013	EV	∅ 74.0		A20A	∅ 82.7	
AB	∅ 71.6	006	EV	∅ 74.0	021	B21A1	∅ 83.0	037
AB	∅ 71.6		EV	∅ 74.0		B20B4	∅ 84.0	
AB	∅ 71.6		EM1	∅ 74.0		B20Z2	∅ 84.0	
EB	∅ 62.0	007	ED3/ED4	∅ 74.0	022	F18A	∅ 85.0	038
ED	∅ 66.6		D13	∅ 75.0			∅ 85.0	
ED	∅ 66.6		D16A	∅ 75.0		F22A/F22A1	∅ 85.0	
ED	∅ 66.6			∅ 75.0		∅ 85.0	039	
EF	∅ 68.0	008	D15B1/D15B2	∅ 75.0	023		∅ 85.0	
CD	∅ 70.0		D15B	∅ 75.0		F22B1	∅ 85.0	
1KR-FE	∅ 71.0	009	D16A	∅ 75.0	024	CB-400	∅ 85.0	040
EJ-DE/EJ-VE	∅ 72.0		Civic 1.5	∅ 75.0		K20A3	∅ 86.0	
CB	∅ 76.0		D16Z6	∅ 75.0		K20Z3	∅ 86.0	
CB	∅ 76.0	010	D16A	∅ 75.0	025	F23A1	∅ 86.0	041
CB	∅ 76.0		D15Z1	∅ 75.0		H22A/H22A1	∅ 87.0	
FE	∅ 68.0		D16Y7	∅ 75.0		H22A/H22A4	∅ 87.0	
K3-VE	∅ 72.0	011	D16Y8	∅ 75.0	026	H23A/H23A1	∅ 87.0	042
K3-VE	∅ 72.0		City 1.5	∅ 75.0		K24A1	∅ 87.0	
K3-VE	∅ 72.0		D17A1	∅ 75.0		K24A2	∅ 87.0	
3SZ-VE	∅ 72.0	012	D13B/D15B	∅ 75.0	027	K24A4	∅ 87.0	043
HC	∅ 76.0		D17A2	∅ 75.0		H22A	∅ 87.0	
HD	∅ 76.0		D15	∅ 75.0		C25A1	∅ 84.0	
HD	∅ 76.0	013	CIVIC EXI	∅ 75.0	028	J30A	∅ 86.0	044
HE	∅ 76.0		CIVIC VTI	∅ 75.0		J30A4	∅ 86.0	
			EK1	∅ 77.0		C27A	∅ 87.0	
			ED/EK1	∅ 77.0	029	J35A1	∅ 89.0	045
			ED/EK1	∅ 77.0		J35A3	∅ 89.0	
			EK	∅ 77.0				

INDEX

J32A	∅ 89.0	046	4ZA1	∅ 82.0	061	B3	∅ 71.0	076
C32A1	∅ 90.0		4ZA1	∅ 82.0		B3	∅ 71.0	
C35A1	∅ 90.0		G180/G180Z	∅ 84.0		B3	∅ 71.0	
			G180Z	∅ 84.0	062	B3	∅ 71.0	077
			G180S/G180SR	∅ 84.0		TC	∅ 73.0	
HYUNDAI		047-056	G180/G180Z	∅ 84.0		TC	∅ 73.0	
G4HC	∅ 66.0	047	4ZB1/G180Z	∅ 84.0	063	TC New	∅ 73.0	078
PICANTO	∅ 67.0		G180Z	∅ 84.0		J4D/JJA/JJB	∅ 73.97	
1.3	∅ 71.5		X 22 SE/Y 22 SE	∅ 86.0		ZJ	∅ 74.0	
G4EH	∅ 71.5	048	X 22 SE/Y 22 SE	∅ 86.0	064	UA	∅ 75.0	079
4G36	∅ 73.0		G200Z	∅ 87.0		UA New	∅ 75.0	
4G33	∅ 73.0		G200/G200Z	∅ 87.0		Z5-DE	∅ 75.3	
X1	∅ 75.5	049	G200	∅ 87.0	065	C4	∅ 76.0	080
G4EK	∅ 75.5		G200W	∅ 87.0		UC	∅ 77.0	
G4EK	∅ 75.5		G200W	∅ 87.0		E3	∅ 77.0	
G4EK/G4FK	∅ 75.5	050	4ZC1	∅ 88.0	066	E5	∅ 77.0	081
G4EK	∅ 75.5		4ZC1	∅ 88.0		E5	∅ 77.0	
1.5	∅ 75.5		4ZC1	∅ 88.0		E3	∅ 77.0	
G4AJ/G4DJ	∅ 75.5	051	4ZD1	∅ 89.3	067	E5	∅ 77.0	082
G4EK-T	∅ 75.5		4ZD1	∅ 89.3		VB	∅ 78.0	
G4ED	∅ 76.5		4ZD1	∅ 89.3		VB	∅ 78.0	
G4ED	∅ 76.5	052	4ZE1	∅ 92.6	068	NA	∅ 78.0	083
G4GR	∅ 77.4		4ZE1	∅ 92.6		NA New	∅ 78.0	
Y2	∅ 80.6		6VD1	∅ 93.4		B6	∅ 78.0	
G4CN/G4DM	∅ 81.5	053	6VD1	∅ 93.4	069	B5	∅ 78.0	084
G4CN	∅ 82.0		6VD1	∅ 93.4		B6-ZE/B6-ME	∅ 78.0	
G4GM	∅ 82.0		6VE1	∅ 93.4		NA-II	∅ 78.0	
G4GC/G4GF	∅ 82.0	054	6VE1	∅ 93.4	070	B6	∅ 78.0	085
G4GF	∅ 82.0		6VD1	∅ 93.4		B6	∅ 78.0	
G4CR	∅ 82.3					B6	∅ 78.0	
G4JP	∅ 85.0	055			071	B6T	∅ 78.0	086
Y2	∅ 85.0					B5	∅ 78.0	
G4CS	∅ 86.5					UB	∅ 78.0	
G4JS	∅ 86.5	056	KIA	071-074	71	ZL-VE	∅ 78.0	087
6GBV/G6BA	∅ 86.7		B1	∅ 68.0		B6	∅ 78.0	
6GCU/G6CV	∅ 93.0		B3	∅ 71.0		Z6-DE/ZM-ME	∅ 78.0	
			A3E	∅ 75.5	72	B6	∅ 78.0	088
			A5D/A5E	∅ 75.5		B6	∅ 78.0	
			B6E	∅ 78.0		ZM	∅ 78.0	
ISUZU		057-070	B6D	∅ 78.0	73	ZM	∅ 78.0	089
4XC1 PAIS-3	∅ 77.0	057	A6D	∅ 78.0		B6	∅ 78.0	
4XC1	∅ 77.0		TED	∅ 81.0		B6-ZE	∅ 78.0	
4XC1	∅ 77.0		T8	∅ 81.0				
4XC1	∅ 77.0	058	KRV6	∅ 80.0	74	VC	∅ 80.0	090
G150	∅ 79.0					VC New	∅ 80.0	
4XE1	∅ 80.0					MA New	∅ 80.0	
4XE1 PAIS-8	∅ 80.0	059			75	MA-II	∅ 80.0	091
4XF1	∅ 80.0					VC	∅ 80.0	
G161Z	∅ 82.0					MA	∅ 80.0	
G161	∅ 82.0	060	MAZDA	075-105	075	F6	∅ 81.0	092
G161Z	∅ 82.0		PB	∅ 68.0		F6	∅ 81.0	
G161 II	∅ 82.0		TB	∅ 70.0		VA	∅ 82.0	
			PC	∅ 70.0				

INDEX

VA	∅ 82.0	093	4A31	∅ 66.0	109	4G61	∅ 82.3	126
BP	∅ 83.0		CM99	∅ 66.0		4G61-KC	∅ 82.3	
BP	∅ 83.0	094	4G16-EC	∅ 68.2	110	4G52/G52B	∅ 84.0	127
BP	∅ 83.0		4G11/G11B	∅ 69.5		4G63/G63B	∅ 85.0	
BP	∅ 83.0	095	4G42	∅ 71.0	111	4G63/G63B	∅ 85.0	128
FP	∅ 83.0		4G13/G13B	∅ 71.0		4G63/G63B	∅ 85.0	
FP	∅ 83.0	096	4G13	∅ 71.0	112	4G63/G63K	∅ 85.0	129
FS	∅ 83.0		4G13 New	∅ 71.0		4G63/G63B	∅ 85.0	
FS	∅ 83.0	097	4G13 New	∅ 71.0	113	4G63/G63D	∅ 85.0	130
L8	∅ 83.0		4G13	∅ 71.0		4G63	∅ 85.0	
BP	∅ 83.0	098	4G17	∅ 72.2	114	4G63T/G63DT	∅ 85.0	131
BP-Z3	∅ 83.0		KE44	∅ 73.0		4G63T/G63BTS	∅ 85.0	
F8	∅ 86.0	099	KE46	∅ 73.0	115	4G63/G63DM	∅ 85.0	132
FE	∅ 86.0		4G30	∅ 73.0		4G63/G63DH	∅ 85.0	
F2	∅ 86.0	100	4G33	∅ 73.0	116	4G63/G63DMK	∅ 85.0	133
FE	∅ 86.0		4G33	∅ 73.0		4G63/G63DP	∅ 85.0	
FE	∅ 86.0	101	4G36	∅ 73.0	117	4G63/G63DK	∅ 85.0	134
FE	∅ 86.0		4G36	∅ 73.0		4G63/G63SP New	∅ 85.0	
F2	∅ 86.0	102	4G12/G12B	∅ 74.0	118	4G63/G63DT New	∅ 85.0	135
FE	∅ 86.0		4G31	∅ 74.5		4G63	∅ 85.0	
FE	∅ 86.0	103	C12	∅ 74.5	119	4G63/G63N New	∅ 85.0	136
FE	∅ 86.0		4A91	∅ 75.0		4G63	∅ 85.0	
FET	∅ 86.0	104	4G15/G15B	∅ 75.5	120	4G63-D4	∅ 85.0	137
F2T	∅ 86.0		4G15	∅ 75.5		4G64/G64B	∅ 86.5	
F2	∅ 86.0	105	4G15 New	∅ 75.5	121	4G64/G64B	∅ 86.5	138
FE	∅ 86.0		4G15 New	∅ 75.5		4G64/G64K	∅ 86.5	
F2	∅ 86.0	106	4G15-S3	∅ 75.5	122	4G64	∅ 86.5	139
L3	∅ 87.5		4G18	∅ 76.0		4G69	∅ 87.0	
LF	∅ 87.5	107	4G18-S4	∅ 76.0	123	4G69	∅ 87.0	140
G6	∅ 92.0		4G41/KE41	∅ 76.5		4G53	∅ 88.0	
JF	∅ 74.0	108	4G41/G41R	∅ 76.5	124	4G54/G54B	∅ 91.1	141
KF(L/R)	∅ 78.0		4G32	∅ 76.9		4G54/G54B	∅ 91.1	
KL(L/R)	∅ 84.5	109	4G32/G32R	∅ 76.9	125	4G54/G54B	∅ 91.1	142
JE	∅ 90.0		4G32/G32J	∅ 76.9		4G54/G54B	∅ 91.1	
JE-ZE	∅ 90.0	110	4G32/G32B	∅ 76.9	126	4G54T/G54BT	∅ 91.1	143
JE-ZE(L/R)	∅ 90.0		4G32/G32S	∅ 76.9		4G54/G54B	∅ 91.1	
JE-ZE(L/R)	∅ 90.0	111	4G32T	∅ 76.9	127	4G54/G54B	∅ 91.1	144
			4G91	∅ 78.4		6A12 ST-41(L/R)	∅ 78.4	
		112	4G62/G62B	∅ 80.6	128	6A12	∅ 78.4	145
			4G62/G62BT	∅ 80.6		6G73(L/R)	∅ 83.5	
		113	4G37/G37B	∅ 80.6	129	6G72(L/R)	∅ 91.1	146
			4G37/G37B	∅ 80.6		6G72(L/R)	∅ 91.1	
MITSUBISHI		106-142	4G37	∅ 80.6		6G72(L/R)	∅ 91.1	
2G21	∅ 62.0	106	4G51	∅ 81.0	130	6G72	∅ 91.1	147
2G22	∅ 65.0		4G92	∅ 81.0		6G72	∅ 91.1	
2G23	∅ 70.0	107	4G92/G92-S4	∅ 81.0	131	6G72(L/R)	∅ 91.1	148
2G23	∅ 70.0		4G92	∅ 81.0		6G72T	∅ 91.1	
2G24	∅ 76.0	108	4G93	∅ 81.0	132	6G74	∅ 93.0	149
2G25	∅ 78.0		4G93	∅ 81.0		6G74	∅ 93.0	
3G82	∅ 65.0	109	4G93	∅ 81.0	133	6G74	∅ 93.0	150
3G83	∅ 65.0		4G93	∅ 81.0		6G75	∅ 95.0	
3A91	∅ 75.0		4G94	∅ 81.5				

INDEX

			QG18	∅ 80.0		U20	∅ 87.2	
			QG18DE	∅ 80.0	159	Z24	∅ 89.0	176
NISSAN		143-196	QG18DE	∅ 80.0		Z24/Z24I	∅ 89.0	
MA10	∅ 68.0		J18	∅ 80.5		KA24E	∅ 89.0	
MA10S	∅ 68.0	143	NA16/NA16S	∅ 81.5	160	KA24E	∅ 89.0	177
D7F 722	∅ 69.0		SR18/SR18DI	∅ 82.5		KA24DE	∅ 89.0	
D4F 712/730	∅ 69.0		CA18N	∅ 82.7		KA24DE	∅ 89.0	
CG10DE	∅ 71.0	144	CA18N	∅ 82.7	161	KA24DE	∅ 89.0	178
CG13DE	∅ 71.0		F4R 720	∅ 82.7		QR20DE	∅ 89.0	
MA12S	∅ 71.0		L16	∅ 83.0		QR25DE	∅ 89.0	
GA13/GA13DS	∅ 71.0	145	L14/L16	∅ 83.0	162	K21	∅ 89.0	179
CG10DE	∅ 71.0		CA18D	∅ 83.0		K25	∅ 89.0	
CR12DE	∅ 71.0		CA18	∅ 83.0		QR25DE	∅ 89.0	
A12S	∅ 73.0	146	CA18S	∅ 83.0	163	QR25DE	∅ 89.0	180
J13	∅ 73.0		CA18ET/CA18T	∅ 83.0		KA24DE	∅ 89.0	
A10S	∅ 73.0		CA18DE	∅ 83.0		H25	∅ 92.0	
A13	∅ 73.0	147	L13	∅ 83.0	164	VQ20DE	∅ 76.0	181
E10S	∅ 73.0		L14	∅ 83.0		VQ20DE	∅ 76.0	
CR14DE	∅ 73.0		L16S	∅ 83.0		VQ20DE	∅ 76.0	
GA14S	∅ 73.6	148	Z16T	∅ 83.0	165	RB20/RB20E	∅ 78.0	182
GA15DS	∅ 73.6		Z16	∅ 83.0		L20A II/L20S	∅ 78.0	
GA15	∅ 73.6		Z16	∅ 83.0		L20A/L20E	∅ 78.0	
GA14DE/GA14DS	∅ 73.6	149	MR18DE	∅ 84.0	166	L20ET	∅ 78.0	183
QG15	∅ 73.6		MR20DE	∅ 84.0		VG20	∅ 78.0	
QG15DE	∅ 73.6		MR20DE	∅ 84.0		VG20ET	∅ 78.0	
A12A	∅ 75.0	150	CA20/CA20S	∅ 84.5	167	L26	∅ 83.0	184
A14S	∅ 75.0		CA20S	∅ 84.5		L24/L26	∅ 83.0	
A14	∅ 76.0		CA20S/CA20E	∅ 84.5		L24	∅ 83.0	
A14 New	∅ 76.0	151	CA20	∅ 84.5	168	L24	∅ 83.0	185
A15S	∅ 76.0		CA20E	∅ 84.5		L24	∅ 83.0	
E13	∅ 76.0		L18/E/S/T	∅ 85.0		L24E	∅ 83.0	
E15S	∅ 76.0	152	L18	∅ 85.0	169	L24/L24E	∅ 83.0	186
E15-ET	∅ 76.0		L18	∅ 85.0		L24E	∅ 83.0	
E16S	∅ 76.0		Z20/Z20S	∅ 85.0		L24E	∅ 83.0	
GA16DE	∅ 76.0	153	Z20E	∅ 85.0	170	VQ23DE	∅ 85.0	187
GA16DE/GA16DS	∅ 76.0		Z20/Z20E	∅ 85.0		P40	∅ 85.7	
GA16I	∅ 76.0		Z20/Z20S	∅ 85.0		L28E	∅ 86.0	
E16I/E16S	∅ 76.0	154	L20B	∅ 85.0	171	L28E	∅ 86.0	188
E15S	∅ 76.0		L20B	∅ 85.0		RB30/RB30E	∅ 86.0	
E15S	∅ 76.0		SR20DE	∅ 86.0		L28/L28E	∅ 86.0	
GA16DE/GA16DS	∅ 76.0	155	NA20S	∅ 86.0	172	L28	∅ 86.0	189
QG16	∅ 76.0		SR20DE	∅ 86.0		RB30/RB30E	∅ 86.0	
QG16DE	∅ 76.0		SR20DET	∅ 86.0		RB24/RB24S	∅ 86.0	
A14	∅ 76.0	156	KA20	∅ 86.0	173		∅ 86.0	190
J15/J16	∅ 78.0		SR20DE	∅ 86.0		VG30/VG30E	∅ 87.0	
GA16S	∅ 78.0		Z22	∅ 87.0		VG30DE	∅ 87.0	
CA16S	∅ 78.0	157	Z22/Z22E	∅ 87.0	174	VG30DDT	∅ 87.0	191
CA16S	∅ 78.0		H20	∅ 87.2		VG30T	∅ 87.0	
HR16DE	∅ 78.0		H20 II	∅ 87.2		VG30E	∅ 87.0	
HR16DE	∅ 78.0	158	R	∅ 87.2	175	VG30E(L/R)	∅ 87.0	192
K4M 752	∅ 79.5		H20	∅ 87.2		VG33E(L/R)	∅ 91.5	

INDEX

VQ30DE	∅ 93.0	193				TOYOTA	221-271	
VQ30DE	∅ 93.0					1KR-FE	∅ 71.0	
VQ35DE	∅ 95.5		SUZUKI	207-219		1SZ-FE	∅ 69.0	221
VQ35DE	∅ 95.5	194	L30/L40	∅ 61.0	207	1E/1E-L	∅ 70.5	
VQ40DE	∅ 95.5		L50	∅ 61.0		2K	∅ 72.0	
TB42	∅ 96.0		L50	∅ 61.0		2SZ-FE	∅ 72.0	222
VH45DE	∅ 93.0	195	L60	∅ 68.0	208	3SZ-FE	∅ 72.0	
VK56DE	∅ 98.0		LJ50 ST10/ST20	∅ 61.0		2E	∅ 73.0	
TB45	∅ 99.5		LJ50 ST30	∅ 61.0		2E	∅ 73.0	223
TB48DE	∅ 99.5	196	F5A	∅ 62.0	209	3E/3E-E	∅ 73.0	
			F6A	∅ 65.0		4E-FE	∅ 74.0	
			F6A	∅ 65.0		5E-FE	∅ 74.0	224
			F6A	∅ 65.0		5E-FE	∅ 74.0	
			F8B	∅ 68.5	210	4E-FE	∅ 74.0	
SAMSUNG		197-197	G10	∅ 74.0		3K/3K-H/4K/4K-C	∅ 75.0	225
SM3	∅ 73.6	197	G10/G10A	∅ 74.0		4K/4K-E/4K-U	∅ 75.0	
SM5	∅ 82.5		G10T	∅ 74.0	4K	∅ 75.0	226	
SM5	∅ 86.0		F8A	∅ 62.0	1NZ-FE/2NZ-FE	∅ 75.0		
			F8A	∅ 62.0	1NZ-FE	∅ 75.0		
			F10A	∅ 65.5	212	2NZ-FE	∅ 75.0	
SSANGYONG		198-200	G10	∅ 72.0		2A	∅ 76.0	227
M111	∅ 89.9	198	G13	∅ 74.0	213	2A	∅ 76.0	
M111	∅ 89.9		G13/G13A	∅ 74.0		3P	∅ 76.6	
M111	∅ 89.9		G13	∅ 74.0		4P	∅ 76.6	228
M111	∅ 90.9	199	G13	∅ 74.0	214	4P	∅ 76.6	
M111	∅ 90.9		G13/G13B	∅ 74.0		1A/1A-C/1A-U	∅ 77.5	
M104	∅ 89.9		G13/G13A	∅ 74.0		3A	∅ 77.5	229
M104	∅ 89.9	200	G13/G13B	∅ 74.0	215	2R	∅ 78.0	
			G13BB	∅ 74.0		5A-F	∅ 78.7	
			G13BB	∅ 74.0		5A-F	∅ 78.7	230
			G16/G16A	∅ 75.0	216	8A-FE	∅ 78.7	
			G16/G16B	∅ 75.0		1ZZ-FE	∅ 79.0	
			G16	∅ 75.0		3ZZ-FE	∅ 79.0	231
SUBARU		201-206	G16	∅ 75.0	217	4ZZ-FE	∅ 79.0	
EK23 New	∅ 76.0	201	G16	∅ 75.0		1ZZ-FE	∅ 79.0	
EF10	∅ 78.0		M13A	∅ 78.0		1ZZ-FE	∅ 79.0	232
EF12	∅ 78.0	202	M15A	∅ 78.0	218	12R	∅ 80.5	
EF10	∅ 78.0		J20A	∅ 84.0		5K	∅ 80.5	
EA61	∅ 76.0		H20A	∅ 78.0		5K	∅ 80.5	233
EA65 New	∅ 83.0	203	H25A	∅ 84.0	219	7K	∅ 80.5	
EA63	∅ 85.0		H27A	∅ 88.0		1S/1S-L/1S-U	∅ 80.5	
EA71	∅ 92.0					1S/1S-L/1S-U	∅ 80.5	234
EA71 New	∅ 92.0	204			220	5K	∅ 80.5	
EA82(L/R)	∅ 92.0					3ZR-FE	∅ 80.5	
EJ20T	∅ 92.0					3ZR-FAE/3ZR-FBE	∅ 80.5	235
EJ20T	∅ 92.0	205	TATA	220-220	220	2ZR-FE	∅ 80.5	
EJ20	∅ 92.0		1.4 MPEI	∅ 75.0		4A-C/4A-LC	∅ 81.0	
EJ22(L/R)	∅ 96.9					4A-GE/4A-GEL	∅ 81.0	236
EJ25	∅ 99.5	206			220	4A/4A-GE/C	∅ 81.0	
EJ25	∅ 99.5							
EJ257	∅ 99.5							



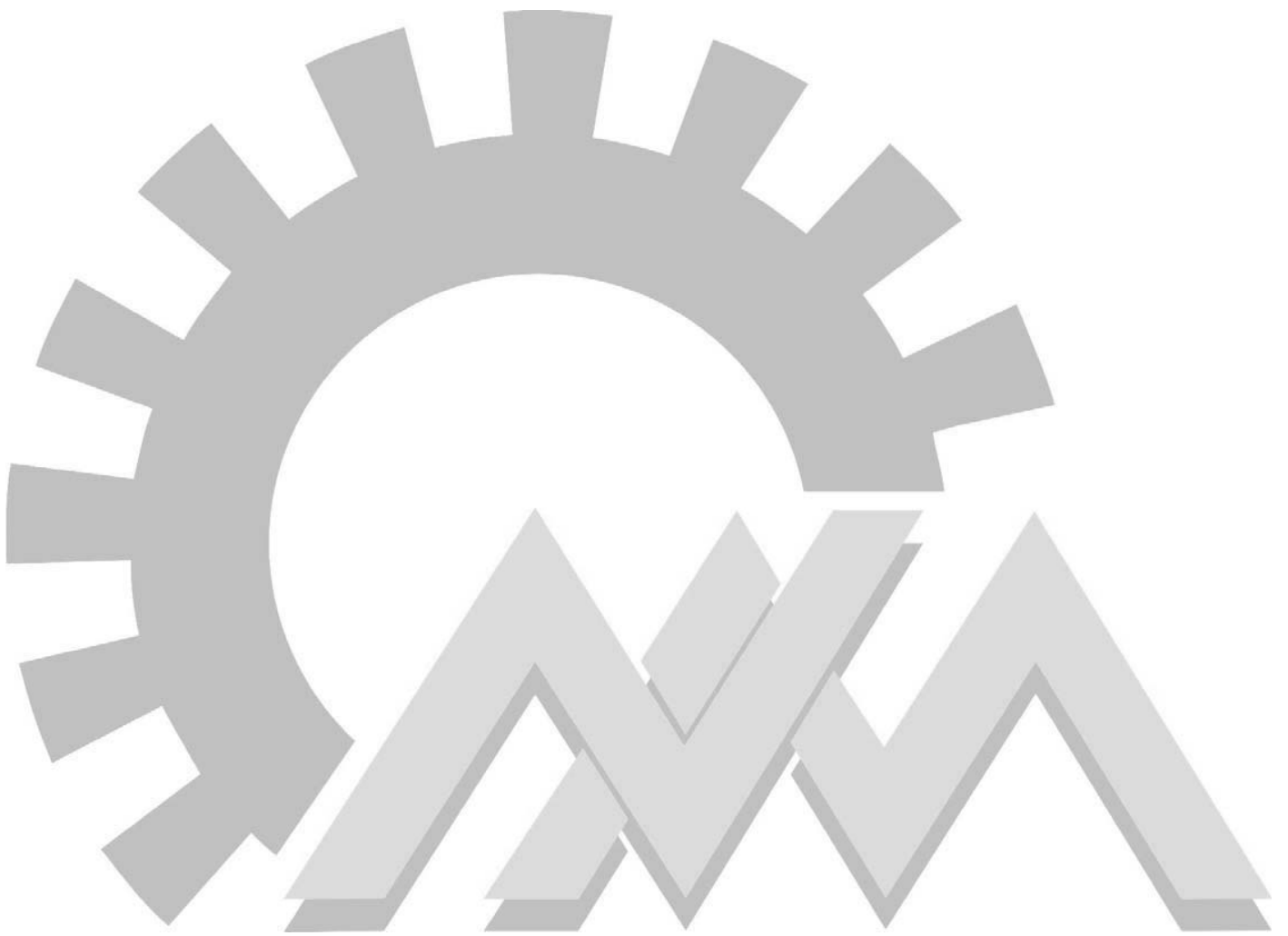

INDEX

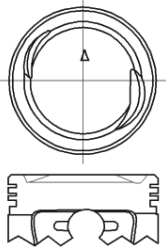
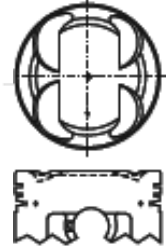

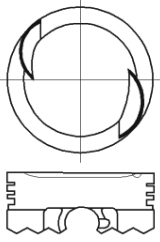
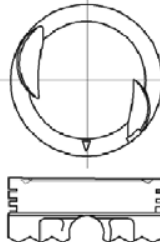
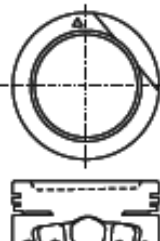
4A-F/4A-FE	∅ 81.0	237	18R	∅ 88.5	254	1FZ-FE	∅ 100.0	271
4A-GEU	∅ 81.0		20R	∅ 88.5		1UZ-FE	∅ 87.5	
7A-FE	∅ 81.0		20R	∅ 88.5		2UZ-FE	∅ 94.0	
4A-FE/4A-FE	∅ 81.0	238	20R 4 RINGS	∅ 88.5	255			
4A/4A-GEL/C	∅ 81.0		2AZ-FE	∅ 88.5				
7A-FE	∅ 81.0		4Y/4Y-EC	∅ 91.0				
4A-L	∅ 81.0	239	4Y	∅ 91.0	256			
4A-GE	∅ 81.0		22R/22R-E/EC	∅ 91.9				
2ZZ-GE	∅ 82.0		22R	∅ 91.9				
4S-FE/4S-FI	∅ 82.5	240	22R-TEC	∅ 91.9	257			
4S	∅ 82.5		5P	∅ 93.0				
21R	∅ 84.0		2RZ	∅ 95.0				
21R	∅ 84.0	241	3RZ-FE	∅ 95.0	258			
21R	∅ 84.0		2RZ-FE	∅ 95.0				
21R/21R-C	∅ 84.0		2RZ-E	∅ 95.0				
21R-C	∅ 84.0	242	2TZ-FE	∅ 95.0	259			
2S-C/2S-ELC	∅ 84.0		2TR-FE	∅ 95.0				
2S-EL	∅ 84.0		3RZ-FE	∅ 95.0				
2T	∅ 85.0	243	1G-E	∅ 75.0	260			
3T	∅ 85.0		1G-E	∅ 75.0				
2T/2T-B	∅ 85.0		1G-GZE	∅ 75.0				
2T/2T-C	∅ 85.0	244	1G-FE	∅ 75.0	261			
2T/2T-B/2T-C	∅ 85.0		1G-GEU	∅ 75.0				
2T-B	∅ 85.0		2M	∅ 75.0				
13T	∅ 85.0	245	2M	∅ 75.0	262			
8R	∅ 86.0		4M	∅ 80.0				
8R	∅ 86.0		4M	∅ 80.0				
1Y	∅ 86.0	246	4M	∅ 80.0	263			
2Y/2Y-C	∅ 86.0		5M-GE	∅ 83.0				
3Y/3Y-EC	∅ 86.0		5M/5M-E	∅ 83.0				
3S-FE	∅ 86.0	247	7M-GE	∅ 83.0	264			
3S-FE	∅ 86.0		5M-GE	∅ 83.0				
3S-GELU	∅ 86.0		7M-GTE	∅ 83.0				
1RZ	∅ 86.0	248	2JZ-GE	∅ 86.0	265			
1RZ	∅ 86.0		3VZ-FE	∅ 87.5				
3S-FE	∅ 86.0		3VZ-E(L/R)	∅ 87.5				
3S-FE	∅ 86.0	249	2VZ-FE	∅ 87.5	266			
3S-FE	∅ 86.0		1MZ-FE(L/R)	∅ 87.5				
3S-GEL/GELC	∅ 86.0		1MZ-FE(L/R)	∅ 87.5				
3S-GE	∅ 86.0	250	F	∅ 90.0	267			
3S-FE	∅ 86.0		F	∅ 90.0				
3Y/3Y-C	∅ 86.0		F	∅ 90.0				
1AZ-FE	∅ 86.0	251	3MZ-FE	∅ 92.0	268			
1TR-FE	∅ 86.0		5VZ-FE	∅ 93.5				
3S-GE	∅ 86.0		2F	∅ 94.0				
5S-FE	∅ 87.0	252	2F	∅ 94.0	269			
5S-FE	∅ 87.0		3F	∅ 94.0				
3R	∅ 88.0		3F-E	∅ 94.0				
5R	∅ 88.0	253	1GR-FE	∅ 94.0	270			
5R	∅ 88.0		2GR-FE	∅ 94.0				
5R	∅ 88.0		1FZ-FE	∅ 100.0				



MOTOR - TYP	Kolben + Ringe Piston + Rings Pistones + Anillos	LAUFBUCHSE CYL. SLEEVE CAMISAS	KOLBENSATZ PISTON SET PISTONES KIT	RINGSATZ RING SET ANILLOS	KOLBEN PISTON PISTONES	
CHANA JL465Q1 Bore Dia. 66.0 mm 4 cyl. 1,000 cc RAINBOW (06-) SOHC 16V	KBS93500	LB93500 length outside diameter flange diameter flange depth	KB93500 length 54.0 comp. height 23.6 -3.5 -5.0 pin = 16.0 x 53.5	KR93500 top 1.5 2nd 1.5 oil 2.8 N- R- T-		
CHANA JL474Q Bore Dia. 74.0 mm 4 cyl. 1,298 cc RAINBOW (06-) SOHC 16V	KBS93510	LB93510 length 140.0 outside diameter 78.0 flange diameter flange depth	KB93510 length 56.1 comp. height 29.2 -1.9 pin = 19.0 x 62.0 circlip required	KR93510 top 1.2 2nd 1.2 oil 2.5 N- R- T-		
		length outside diameter flange diameter flange depth	length comp. height pin = x	top 2nd oil N- R- T-		

MOTOR - TYP	KOLBEN + RINGE PISTON + RINGS PISTONES + ANILLOS	LAUFBUCHSE CYL. SLEEVE CAMISAS	KOLBENSATZ PISTON SET PISTONES KIT	RINGSATZ RING SET ANILLOS	KOLBEN PISTON PISTONES
DAEWOO F8C Bore Dia. 68.5 mm 3 cyl. 796 cc MATIZ (98-02) SPARK SOHC 6V	KBS93520	LB93520 length 160.0 outside diameter 72.5 flange diameter flange depth	KB93520 length 55.0 comp. height 25.0 -2.5 -3.2 pin = 16.0 x 52.8 circlip required	KR93520 top 1.2 2nd 1.5 oil 2.8 N-SWD20-002 SWL02-395 R-40021 T-41002	
			12111-078B00-000 12111-A78B01-0A0 12111-A78B01-0B0 94581407 96239399 96286490	12140-78B00 94599003	
DAEWOO B10S Bore Dia. 68.5 mm 4 cyl. 995 cc MATIZ II (06-07) SPARK SOHC 8V	KBS93530	LB93530 length outside diameter flange diameter flange depth	KB93530 length 52.2 comp. height 25.2 -1.0 -3.5 pin = 17.0 x 53.4 circlip required	KR93530 top 1.2 2nd 1.2 oil 2.5 N-SWD20-005 SWL03-148 R- T-	
			96325189 96325191 96567383 96567384 96567385 96567386	96325192 96611457 96611458	
DAEWOO A15DM Bore Dia. 76.5 mm 4 cyl. 1,498 cc LANOS (97-01) SOHC 8V	KBS93540	LB93540 length 180.0 outside diameter 80.5 flange diameter flange depth	KB93540 length 48.4 comp. height 28.6 -4.1 pin = 18.0 x 54.5 circlip not required	KR93540 top 1.5 2nd 1.5 oil 3.0 N-SWD20-003 SWL02-419 R-40345 T-41001	
			90264520 93740213 93740214 96081975 96143171 96350120 S1220008 S1220009	93742293 93742294 93742295 NP960	

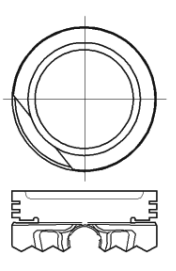

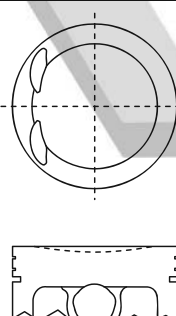
MOTOR - TYP	KOLBEN + RINGE PISTON + RINGS PISTONES + ANILLOS	LAUFBUCHSE CYL. SLEEVE CAMISAS	KOLBENSATZ PISTON SET PISTONES KIT	RINGSATZ RING SET ANILLOS	KOLBEN PISTON PISTONES
DAEWOO A15MF Bore Dia. 76.5 mm 4 cyl. 1,498 cc LANOS DOHC 16V	KBS93550	LB93550 length 180.0 outside diameter 80.5 flange diameter flange depth	KB93550 length 51.3 comp. height 28.2 -2.0 pin = 18.0 x 54.8 circlip not required 96182813 96182814 93740215 93740216 S1220010 S1220011	KR93550 top 1.5 2nd 1.5 oil 3.0 N-SWD20-003 SWL 02-419 R-40345 T-41001 93742293 93742294 93742295 NP960	 
			pin = 18.0 x 56.0 circlip not required 96182163	N-SWD20-003 SWL 02-419 R-40345 T-41001 93742293 93742294 93742295 NP960	
DAEWOO A15MF Bore Dia. 76.5 mm 4 cyl. 1,498 cc DOHC 16V	KBS93551	LB93551 length 180.0 outside diameter 80.5 flange diameter flange depth	KB93551 length 51.9 comp. height 28.3 +0.6 pin = 18.0 x 56.0 circlip not required 96182163	KR93551 top 1.5 2nd 1.5 oil 3.0 N-SWD20-003 SWL 02-419 R-40345 T-41001 93742293 93742294 93742295 NP960	 
			pin = 18.0 x 56.0 circlip not required 96182163	N-SWD20-003 SWL 02-419 R-40345 T-41001 93742293 93742294 93742295 NP960	
DAEWOO A13DM A14DM Bore Dia. 76.5 mm 4 cyl. 1,349 cc LANOS SOHC	KBS93560	LB93560 length 180.0 outside diameter 80.5 flange diameter flange depth	KB93560 length comp. height pin = x	KR93560 top 1.5 2nd 1.5 oil 3.0 N-SWD20-003 SWL 02-419 R-40345 T-41001 93742293 93742294 93742295 NP960	
			pin = x	N-SWD20-003 SWL 02-419 R-40345 T-41001 93742293 93742294 93742295 NP960	

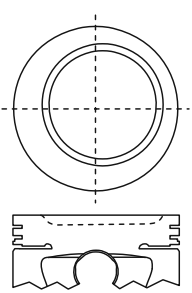
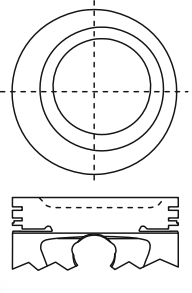

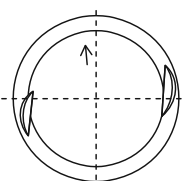
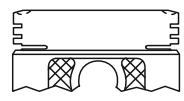
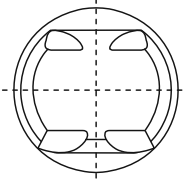
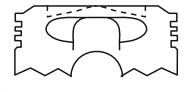
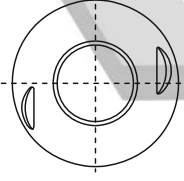
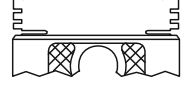
ENGINE MODEL	PISTON+RINGS	LAUFBUCHSE CYL. SLEEVE CAMISAS	KOLBENSATZ PISTON SET PISTONES KIT	RINGSATZ RING SET ANILLOS	KOLBEN PISTON PISTONES
DAEWOO 1.5 NEW Bore Dia. 76.5 mm 4 cyl. 1,498 cc	KBS93570	LB93570 length 180.0 outside diameter 83.0 flange diameter flange depth	KB93570 length 51.4 comp. height 28.4 -5.0 pin = 18.0 x 54.6 circlip not required	KR93570 top 1.5 2nd 1.5 oil 3.0 N-SWD20-003 SWL 02-419 R-40345 T-41001 93742293 93742294 93742295 NP960	
DAEWOO A16DM A16MF Bore Dia. 79.0 mm 4 cyl. 1,598 cc LANOS NUBIRA DOHC 16V	KBS93580	LB93580 length 180.0 outside diameter 83.0 flange diameter flange depth	KB93580 length 51.3 comp. height 28.3 -1.6 -3.0 pin = 18.0 x 54.7 circlip not required	KR93580 top 1.2 2nd 1.5 oil 3.0 N-SWD20-004 SWL 03-047 R- T- S1220014 S1220015 S1220016	
DAEWOO C 20 SE X 22 SE Bore Dia. 86.0 mm 4 cyl. 1,998 cc DOHC 16V	KBS93590	LB93590 length outside diameter flange diameter flange depth	KB93590 length 55.4 comp. height 30.4 -6.5 pin = 21.0 x 61.5 circlip required	KR93590 top 1.5 2nd 1.5 oil 3.0 N-SWD20-006 R- T- 92029793 92029795 92062027 92062028	

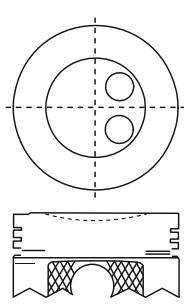
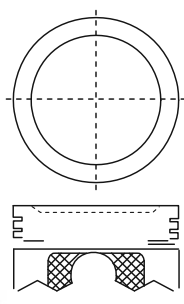
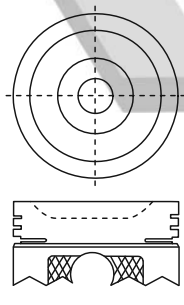

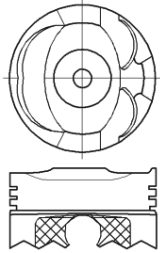
MOTOR - TYP	KOLBEN + RINGE PISTON + RINGS PISTONES + ANILLOS	LAUFBUCHSE CYL. SLEEVE CAMISAS	KOLBENSATZ PISTON SET PISTONES KIT	RINGSATZ RING SET ANILLOS	KOLBEN PISTON PISTONES
DAEWOO 2.0i Bore Dia. 86.0 mm 4 cyl. 1,998 cc ESPERO SOHC 8V	KBS93600	LB93600 length outside diameter flange diameter flange depth	KB93600 length 55.6 comp. height 30.5 -5.1 pin = 21.0 x 61.5 circlip not required	KR93600 top 1.5 2nd 1.5 oil 3.0 N-SWD20-006 R- T- 92029793 92062027 92062028 92062795	
			92061657 92061659 92061704		
DAEWOO 2.0i Bore Dia. 86.0 mm 4 cyl. 1,998 cc ESPERO (93-94) SOHC 8V	KBS93601	LB93601 length outside diameter flange diameter flange depth	KB93601 length 55.5 comp. height 30.4 -5.0 pin = 21.0 x 61.5	KR93601 top 1.5 2nd 1.5 oil 3.0 N-SWD20-006 R- T- 92029793 92062027 92062028 92062795	
		length outside diameter flange diameter flange depth	length comp. height	top 2nd oil	

MOTOR - TYP	KOLBEN + RINGE PISTON + RINGS PISTONES + ANILLOS	LAUFBUCHSE CYL. SLEEVE CAMISAS	KOLBENSATZ PISTON SET PISTONES KIT	RINGSATZ RING SET ANILLOS	KOLBEN PISTON PISTONES		
DAIHATSU AB Bore Dia. 71.6 mm 2 cyl. 547 cc SOHC 4V	KBS93610	LB93610	length	length 63.2	top 1.5	 	
			outside diameter	comp. height +0.8	2nd 1.5		oil 2.8
			flange diameter	pin = 18.0 x 60.2 circlip not required	N-SCD10-023 SWD10-023 R-12220 / 12230 T-31024 / 31039		
			flange depth	13101-87701	13011-87701 13011-87702 13011-87705 13011-87709 13011-87710 13011-87714		
DAIHATSU AB Bore Dia. 71.6 mm 2 cyl. 547 cc S55W	KBS93611	LB93611	length	length 63.1	top 1.5	 	
			outside diameter	comp. height +0.6	2nd 1.5		oil 2.8
			flange diameter	pin = 18.0 x 60.0	N-SCD10-023 SWD10-023 R-12220 / 12230 T-31024 / 31039		
			flange depth	13101-87706	13011-87701 13011-87702 13011-87705 13011-87709 13011-87710 13011-87714		
DAIHATSU AB Bore Dia. 71.6 mm 2 cyl. 547 cc SOHC 4V	KBS93612	LB93612	length	length 63.9	top 1.5	 	
			outside diameter	comp. height +1.2	2nd 1.5		oil 2.8
			flange diameter	pin = 18.0 x 60.0 circlip not required	N-SCD10-023 SWD10-023 R-12220 / 12230 T-31024 / 31039		
			flange depth	13101-87715 13101-87732	13011-87701 13011-87702 13011-87705 13011-87709 13011-87710 13011-87714		

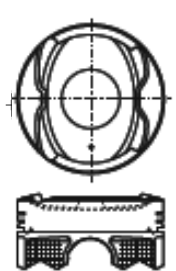
MOTOR - TYP	KOLBEN + RINGE PISTON + RINGS PISTONES + ANILLOS	LAUFBUCHSE CYL. SLEEVE CAMISAS	KOLBENSATZ PISTON SET PISTONES KIT	RINGSATZ RING SET ANILLOS	KOLBEN PISTON PISTONES
DAIHATSU EB Bore Dia. 62.0 mm 3 cyl. 547 cc	KBS23500	LB23500 length outside diameter flange diameter flange depth	KB23500 length 54.8 comp. 27.8 height -0.5 -2.9	KR23500 top 1.2 2nd 1.5 oil 2.8	
			pin = 16.0 x 52.0 circlip not required	N-SWD10-029 R-12010 T-31033	
				13011-87206 13011-87222	
DAIHATSU ED Bore Dia. 66.6 mm 3 cyl. 846 cc CUORE MOVE (90-98) SOHC 6V	KBS93630	LB93630 length outside diameter flange diameter flange depth	KB93630 length 56.5 comp. 28.5 height -6.2	KR93630 top 1.2 2nd 1.5 oil 2.8	
			pin = 18.0 x 51.0 circlip not required	N-SWD10-045 R-12915 T-31040/ 31047	
			13101-87241 13101-87246 13102-87241 13102-87246 13103-87241 13103-87246 13104-87241 13104-87246 13105-87241 13105-87246	13011-87208 13011-87232 13012-87208 13012-87232 13013-87208 13013-87232 13014-87208 13014-87232 13015-87208 13015-87232	
DAIHATSU ED Bore Dia. 66.6 mm 3 cyl. 846 cc	KBS93631	LB93631 length outside diameter flange diameter flange depth	KB93631 length 56.6 comp. 28.6 height -6.5	KR93631 top 1.2 2nd 1.5 oil 2.8	
			pin = 18.0 x 52.0 circlip not required	N-SWD10-045 R-12915 T-31040/ 31047	
			13211-87250-C	13011-87208 13011-87232 13012-87208 13012-87232 13013-87208 13013-87232 13014-87208 13014-87232 13015-87208 13015-87232	

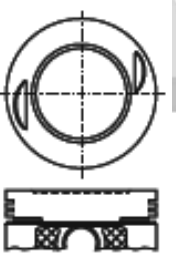
MOTOR - TYP	KOLBEN + RINGE PISTON + RINGS PISTONES + ANILLOS	LAUFBUCHSE CYL. SLEEVE CAMISAS	KOLBENSATZ PISTON SET PISTONES KIT	RINGSATZ RING SET ANILLOS	KOLBEN PISTON PISTONES
DAIHATSU ED Bore Dia. 66.6 mm 3 cyl. 846 cc	KBS93632	LB93632 length outside diameter flange diameter flange depth	length 56.6 comp. 28.6 height -2.3 -3.8	top 1.2 2nd 1.2 oil 2.0	
			pin = 18.0 x 52.0 circlip not required	N- R- T-31050	
			13101-87255	13011-97209	
			2012 NEW		
DAIHATSU EF Bore Dia. 68.0 mm 3 cyl. 659 cc MIRA (90- 95) SOHC 12V	KBS93640	LB93640 length outside diameter flange diameter flange depth	length 54.9 comp. 27.9 height -5.4	top 1.2 2nd 1.5 oil 2.8	
			pin = 18.0 x 52.0 circlip not required	N-SWD10-033 R-12020/ 12025 T-31041	
			13101-85710	13011-87218 13011-87219 13011-87E02 13012-87218 13012-87219 13013-87218 13013-87219 13014-87218 13014-87219 13015-87218/9	
			2012 NEW		
DAIHATSU CD Bore Dia. 70.0 mm 3 cyl. 843 cc	KBS93650	LB93650 length outside diameter flange diameter flange depth	length 64.3 comp. 28.0 height +4.3	top 1.5 2nd 1.5 oil 2.8	
			pin = 18.0 x 60.0 circlip not required	N-SWD10-028 R-12531 T-31027	
			13101-87708 13101-87717 13101-87731	13011-87712 13013-87710	
			2012 NEW		

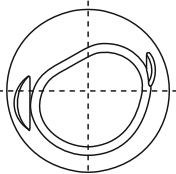
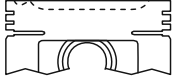
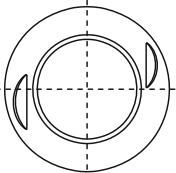
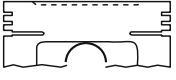
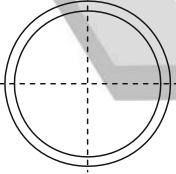
MOTOR - TYP	KOLBEN + RINGE PISTON + RINGS PISTONES + ANILLOS	LAUFBUCHSE CYL. SLEEVE CAMISAS	KOLBENSATZ PISTON SET PISTONES KIT	RINGSATZ RING SET ANILLOS	KOLBEN PISTON PISTONES
DAIHATSU 1KR-FE Bore Dia. 71.0 mm 3 cyl. 998 cc CUORE SIRION (04-) DOHC 12V	KBS97000 skirt MOS2 treated	LB97000 length outside diameter flange diameter flange depth	KB97000 length 47.05 comp. height 29.25 -3.0 -6.3	KR97000 top 1.0 2nd 1.0 oil 1.5	
			pin = 18.0 x 47.0 circlip not required	N- R- T-	
			13101-40020 13101-40021	13011-0Q010 13011-40030	
DAIHATSU EJ-DE EJ-VE Bore Dia. 72.0 mm 3 cyl. 989 cc CUORE MOVE (98-06) DOHC 12V	KBS77500 head anodized	LB77500 length outside diameter flange diameter flange depth	KB77500 length 50.6 comp. height 28.5 -6.8	KR77500 top 1.2 2nd 1.2 oil 2.5	
			pin = 18.0 x 52.0 circlip not required	N-SWD10-047 R-12015 T-31048	
			13101-97201 13102-97201 13103-97201	13011-97201 13011-97210 13012-97201 13012-97208 13013-97201 13013-97210	
DAIHATSU CB Bore Dia. 76.0 mm 3 cyl. 993 cc SOHC 6V	KBS97020	LB97020 length outside diameter flange diameter flange depth	KB97020 length 60.5 comp. height 28.5 -1.5	KR97020 top 1.5 2nd 1.5 oil 2.8	
			pin = 18.0 x 60.0 circlip not required	N-SWD10-024 R-12280/ 12300 T-31028/ 31038	
			13101-87703 13101-87704	13011-87703 13011-87704 13011-87708 13011-87718 13012-87708 13012-87718 13013-87708 13013-87718	

MOTOR - TYP	KOLBEN + RINGE PISTON + RINGS PISTONES + ANILLOS	LAUFBUCHSE CYL. SLEEVE CAMISAS	KOLBENSATZ PISTON SET PISTONES KIT	RINGSATZ RING SET ANILLOS	KOLBEN PISTON PISTONES	
DAIHATSU CB Bore Dia. 76.0 mm 3 cyl. 993 cc CHARADE G100/102/200/202/203 (90-98) SOHC 6V	KBS97021	LB97021	length	length 60.6	top 1.5	 
			outside diameter	comp. height 28.5 -3.8	2nd 1.5 oil 2.8	
			flange diameter	pin = 18.0 x 60.0 circlip not required	N-SWD10-024 R-12280/ 12300 T-31028/ 31038	
			flange depth	13101-87709 13101-87713 13101-87719 13101-87729 13101-87739/42 13102-87713/39 13102-87741 13103-87724/39 13103-87741 13211-87719/29	13011-87703 13011-87704 13011-87708 13011-87718 13012-87708 13012-87718 13013-87708 13013-87718	
DAIHATSU CB Bore Dia. 76.0 mm 3 cyl. 993 cc SOHC 6V	KBS97022	LB97022	length	length 60.5	top 1.5	 
			outside diameter	comp. height 28.5 -1.5	2nd 1.5 oil 2.8	
			flange diameter	pin = 18.0 x 60.0 circlip not required	N-SWD10-024 R-12280/ 12300 T-31028/ 31038	
			flange depth	13101-87736 13211-87711	13011-87703 13011-87704 13011-87708 13011-87718 13012-87708 13012-87718 13013-87708 13013-87718	
DAIHATSU FE Bore Dia. 68.0 mm 4 cyl. 958 cc JEEP F40/F40G	KBS97030	LB97030	length	length 67.0	top 2.0	 
			outside diameter	comp. height 34.0 +0	2nd 2.0 oil 4.0	
			flange diameter	pin = 20.0 x 56.0 circlip required	N-SWD10-020 R-12800 T-	
			flange depth	13101-87104	13011-87103 992-4023-1411	

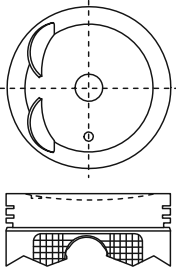
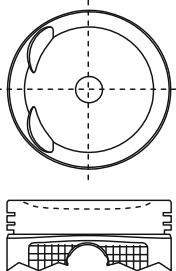
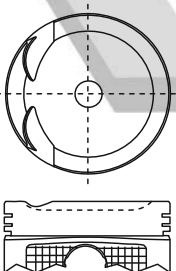
MOTOR - TYP	KOLBEN + RINGE PISTON + RINGS PISTONES + ANILLOS	LAUFBUCHSE CYL. SLEEVE CAMISAS	KOLBENSATZ PISTON SET PISTONES KIT	RINGSATZ RING SET ANILLOS	KOLBEN PISTON PISTONES
DAIHATSU K3-VE Bore Dia. 72.0 mm 4 cyl. 1,297 cc SIRION M100/101 (00-04) DOHC 16V	KBS79500 head, top and 2nd ring lands anodized	LB79500 length outside diameter flange diameter flange depth	KB79500 length 45.2 comp. height 28.1 -2.8 pin = 18.0 x 54.0 circlip not required 13101-97403 13103-97403	KR79500 top 1.2 2nd 1.2 oil 2.0 N- R-12125 T-31049 13011-97401 13011-97404 13013-97401	
			13101-97403 13103-97403	13011-97401 13011-97404 13013-97401	
DAIHATSU K3-VE Bore Dia. 72.0 mm 4 cyl. 1,297 cc COPE SIRION M300/301/311 (04-06) DOHC 16V	KBS79501 head, top and 2nd ring lands anodized	LB79501 length outside diameter flange diameter flange depth	KB79501 length 45.2 comp. height 28.1 -4.05 pin = 18.0 x 54.0 circlip not required 13101-97401 13103-97401	KR79500 top 1.2 2nd 1.2 oil 2.0 N- R-12125 T-31049 13011-97401 13011-97404 13013-97401	
			13101-97401 13103-97401	13011-97401 13011-97404 13013-97401	
DAIHATSU K3-VE Bore Dia. 72.0 mm 4 cyl. 1,297 cc MATERIA SIRION M301/311 (06-) DOHC 16V	KBS79502 head, top and 2nd ring lands anodized	LB79502 length outside diameter flange diameter flange depth	KB79502 length 45.2 comp. height 28.1 -3.95 pin = 18.0 x 54.0 circlip not required 13101-B1030	KR79500 top 1.2 2nd 1.2 oil 2.0 N- R-12125 T-31049 13011-97401 13011-97404 13013-97401	
			13101-B1030	13011-97401 13011-97404 13013-97401	

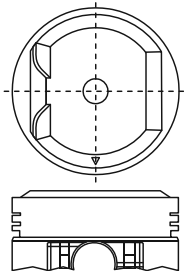
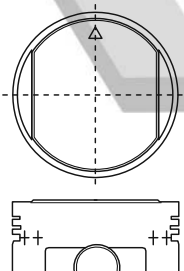
MOTOR - TYP	KOLBEN + RINGE PISTON + RINGS PISTONES + ANILLOS	LAUFBUCHSE CYL. SLEEVE CAMISAS	KOLBENSATZ PISTON SET PISTONES KIT	RINGSATZ RING SET ANILLOS	KOLBEN PISTON PISTONES
DAIHATSU 3SZ-VE Bore Dia. 72.0 mm 4 cyl. 1,495 cc MATERIA SIRION M301/311 (06-) DOHC 16V	KBS97050 head anodized skirt MOS2 treated	LB97050 length outside diameter flange diameter flange depth	KB97050 length 45.5 comp. height 28.0 -6.7 pin = 18.0 x 54.0 circlip not required	KR97050 top 1.2 2nd 1.2 oil 2.0 N- R- T-31055	
			13101-B1021 13103-B1060	13011-B1020 13011-BZ110 13013-B1020	
DAIHATSU HC Bore Dia. 76.0 mm 4 cyl. 1,295 cc CHARADE 1.3i TERIOS 1.3i G100/102 (90-) SOHC 16V	KBS84000	LB84000 length 180.0 outside diameter 80.0 flange diameter flange depth	KB84000 length 63.8 comp. height 30.3 +3.5 pin = 19.0 x 58.0 circlip not required	KR84000 top 1.2 2nd 1.5 oil 3.0 N-SWD10-030/031/034 R-12600 / 12910 T-31035 / 31036 / 31045	
			13101-87105 13101-87111 13102-87105 13102-87112 13211-87105 13211-87111	13011-87104/05 13011-87106/07 13011-87108/09 13011-87110/11 13011-87112/13 13012-87104/06 13012-87107/08 13012-87109/10 13013-87111/12 13013-87113/14	
DAIHATSU HD Bore Dia. 76.0 mm 4 cyl. 1,589 cc APPLAUSE FEROUZA A101/111 F300/310 (88-00) SOHC 16V	KBS97070	LB97070 length 180.0 outside diameter 80.0 flange diameter flange depth	KB97070 length 60.7 comp. height 30.2 +0.5 pin = 19.0 x 58.0 circlip not required	KR97070 top 1.2 2nd 1.5 oil 3.0 N-SWD10-030/031/034 R-12600 / 12910 T-31035 / 31036 / 31045	
			13101-87106 13101-87108 13101-87113 13101-87117 13102-87106 13102-87108 13102-87113 13102-87117	13011-87104/05 13011-87106/07 13011-87108/09 13011-87110/11 13011-87112/13 13012-87104/06 13012-87107/08 13012-87109/10 13013-87111/12 13013-87113/14	

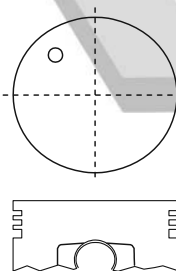
MOTOR - TYP	KOLBEN + RINGE PISTON + RINGS PISTONES + ANILLOS	LAUFBUCHSE CYL. SLEEVE CAMISAS	KOLBENSATZ PISTON SET PISTONES KIT	RINGSATZ RING SET ANILLOS	KOLBEN PISTON PISTONES
HONDA N360 Bore Dia. 62.5 mm 2 cyl. 354 cc	KBS97090	LB97090 length outside diameter flange diameter flange depth	length 67.5 comp. height 26.8 +7.7	top 1.5 2nd 1.5 oil 2.5	
			pin = 17.0 x 52.2 circlip required	N- R-16490 T-32333	
			13101-551-000	13011-551-000 13011-601-000 13101-567-325	
HONDA TN360 Bore Dia. 62.5 mm 2 cyl. 354 cc	KBS97100	LB97100 length outside diameter flange diameter flange depth	length 65.8 comp. height 26.5 +6.3	top 1.5 2nd 1.5 oil 2.5	
			pin = 17.0 x 52.2 circlip required	N- R-16490 T-32333	
			13101-567-000	13011-551-000 13011-601-000 13101-567-325	
HONDA EH Bore Dia. 72.0 mm 2 cyl. 545 cc TNACTY	KBS97110	LB97110 length outside diameter flange diameter flange depth	length 55.5 comp. height 27.5 +0	top 1.5 2nd 1.5 oil 4.0	
			pin = 17.0 x 62.5 circlip not required	N- R-16014/ 16015 T-32358	
			13101-679-010	13011-679-004 13011-679-014 13011-679-621	

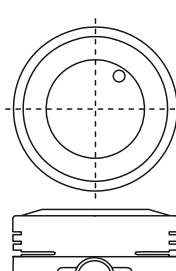
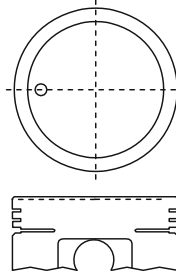
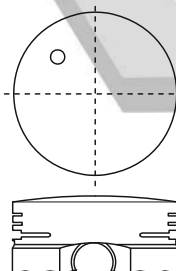
MOTOR - TYP	KOLBEN + RINGE PISTON + RINGS PISTONES + ANILLOS	LAUFBUCHSE CYL. SLEEVE CAMISAS	KOLBENSATZ PISTON SET PISTONES KIT	RINGSATZ RING SET ANILLOS	KOLBEN PISTON PISTONES
HONDA ER Bore Dia. 66.0 mm 4 cyl. 1,231 cc CITY (82-)	KBS97120	LB97120 length outside diameter flange diameter flange depth	KB97120 length 61.8 comp. height 28.8 +0.3 pin = 15.0 x 58.0 circlip not required	KR97120 top 1.2 2nd 1.2 oil 2.8 N- R-16005/16815 T-32365 13011-PD1-004 13011-PD1-005 13011-PZ3-003	
			13101-PZ3-000		
HONDA EB1 Bore Dia. 70.0 mm 4 cyl. 1,169 cc CIVIC SOHC 8V	KBS97130	LB97130 length outside diameter flange diameter flange depth	KB97130 length 60.0 comp. height 27.0 -0.8 pin = 17.0 x 57.0 circlip not required	KR97130 top 1.5 2nd 1.5 oil 2.8 N-SWH30-107 R-16004 T-32345 13011-634-003 13011-634-004 13011-634-013 13011-634-305 13011-643-013	
			13101-634-000		
HONDA EN EB3 Bore Dia. 72.0 mm 4 cyl. 1,238 1,335 cc CIVIC BALLADE SOHC 8V	KBS97140	LB97140 length outside diameter flange diameter flange depth	KB97140 length 65.0 comp. height 27.4 +2.7 pin = 17.0 x 62.0 circlip not required	KR97140 top 1.5 2nd 1.5 oil 4.0 N-SWH30-109/162 R-16007/ 16008 T-32355 13011-673-000 13011-679-621 13011-695-004 13011-PA0-004 13011-PA1-004 13011-PA5-003 13011-PA5-004 13021-PA1-004 13031-PA1-004	
			13101-PA1-010		

HONDA

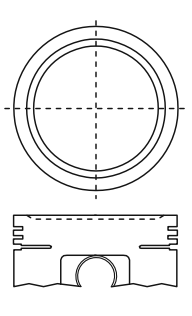
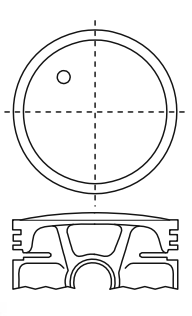
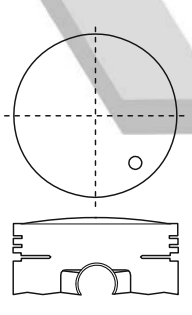
MOTOR - TYP	KOLBEN + RINGE PISTON + RINGS PISTONES + ANILLOS	LAUFBUCHSE CYL. SLEEVE CAMISAS	KOLBENSATZ PISTON SET PISTONES KIT	RINGSATZ RING SET ANILLOS	KOLBEN PISTON PISTONES
HONDA EB5 Bore Dia. 72.0 mm 4 cyl. 1,433 cc 145 COUPLE SOHC 8V	KBS97150	LB97150 length outside diameter flange diameter flange depth	KB97150 length 60.0 comp. height 27.0 -1.5 pin = 17.0 x 62.0 circlip not required 13101-634-670	KR97150 top 1.5 2nd 1.5 oil 2.8 N-SWH30-184 R-16006 T-32346 13011-642-003 13011-642-004 13011-642-305	
			length 60.0 comp. height 27.0 -1.5	top 1.5 2nd 1.5 oil 2.8	
			pin = 17.0 x 62.0 circlip not required 13101-634-670	N-SWH30-184 R-16006 T-32346	
			13011-642-003 13011-642-004 13011-642-305		
HONDA EB2 Bore Dia. 72.0 mm 4 cyl. 1,238 cc CIVIC SOHC 8V	KBS97160	LB97160 length outside diameter flange diameter flange depth	KB97160 length 60.0 comp. height 27.5 +2.5 pin = 17.0 x 62.0 circlip not required 13101-634-671	KR97160 top 1.5 2nd 1.5 oil 4.0 N-SWH30-109/162 R-16007/ 16008 T-32355 13011-673-000 13011-679-621 13011-695-004 13011-PA0-004 13011-PA1-004 13011-PA5-003 13011-PA5-004 13021-PA1-004 13031-PA1-004	
			length 60.0 comp. height 27.5 +2.5	top 1.5 2nd 1.5 oil 4.0	
			pin = 17.0 x 62.0 circlip not required 13101-634-671	N-SWH30-109/162 R-16007/ 16008 T-32355	
			13011-673-000 13011-679-621 13011-695-004 13011-PA0-004 13011-PA1-004 13011-PA5-003 13011-PA5-004 13021-PA1-004 13031-PA1-004		
HONDA EB3 Bore Dia. 72.0 mm 4 cyl. 1,238 cc CIVIC BALLADE SOHC 8V	KBS97170	LB97170 length outside diameter flange diameter flange depth	KB97170 length 60.0 comp. height 27.1 +2.6 pin = 17.0 x 62.0 13101-643-671	KR97170 top 1.5 2nd 1.5 oil 4.0 N-SWH30-109/162 R-16007/ 16008 T-32355 13011-673-000 13011-679-621 13011-695-004 13011-PA0-004 13011-PA1-004 13011-PA5-003 13011-PA5-004 13021-PA1-004 13031-PA1-004	
			length 60.0 comp. height 27.1 +2.6	top 1.5 2nd 1.5 oil 4.0	
			pin = 17.0 x 62.0 13101-643-671	N-SWH30-109/162 R-16007/ 16008 T-32355	
			13011-673-000 13011-679-621 13011-695-004 13011-PA0-004 13011-PA1-004 13011-PA5-003 13011-PA5-004 13021-PA1-004 13031-PA1-004		

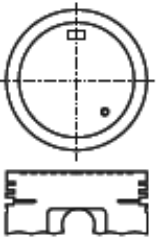
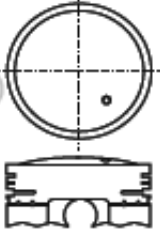
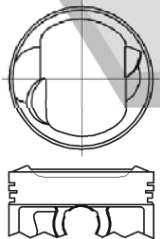
MOTOR - TYP	KOLBEN + RINGE PISTON + RINGS PISTONES + ANILLOS	LAUFBUCHSE CYL. SLEEVE CAMISAS	KOLBENSATZ PISTON SET PISTONES KIT	RINGSATZ RING SET ANILLOS	KOLBEN PISTON PISTONES
HONDA EJ Bore Dia. 72.0 mm 4 cyl. 1,335 cc CIVIC SOHC 8V	KBS97180	LB97180 length outside diameter flange diameter flange depth	KB97180 length 62.4 comp. height 27.4 -0.5 pin = 17.0 x 62.0 circlip not required 13101-PA0-000	KR97180 top 1.5 2nd 1.5 oil 4.0 N-SWH30-109/162 R-16007/ 16008 T-32355 13011-673-000 13011-679-621 13011-695-004 13011-PA0-004 13011-PA1-004 13011-PA5-003 13011-PA5-004 13021-PA1-004 13031-PA1-004	
			length 62.5 comp. height 27.5 +3.5 pin = 17.0 x 62.0	top 1.5 2nd 1.5 oil 4.0 N-SWH30-109/162 R-16007/ 16008 T-32355 13011-673-000 13011-679-621 13011-695-004 13011-PA0-004 13011-PA1-004 13011-PA5-003 13011-PA5-004 13021-PA1-004 13031-PA1-004	
			length 44.7 comp. height 26.2 +2.7 -3.5 pin = 18.0 x 54.0 circlip not required 13101-PWH-000	top 1.0 2nd 1.2 oil 2.0 N- R-16590 T- 13011-REA-Z01 13021-REA-Z01	
			length 62.4 comp. height 27.4 -0.5 pin = 17.0 x 62.0 circlip not required 13101-PA0-000	top 1.5 2nd 1.5 oil 4.0 N-SWH30-109/162 R-16007/ 16008 T-32355 13011-673-000 13011-679-621 13011-695-004 13011-PA0-004 13011-PA1-004 13011-PA5-003 13011-PA5-004 13021-PA1-004 13031-PA1-004	
HONDA EJ EB3 Bore Dia. 72.0 mm 4 cyl. 1,238 1,335 cc CIVIC BALLADE SOHC 8V	KBS97190	LB97190 length outside diameter flange diameter flange depth	KB97190 length 62.5 comp. height 27.5 +3.5 pin = 17.0 x 62.0	KR97190 top 1.5 2nd 1.5 oil 4.0 N-SWH30-109/162 R-16007/ 16008 T-32355 13011-673-000 13011-679-621 13011-695-004 13011-PA0-004 13011-PA1-004 13011-PA5-003 13011-PA5-004 13021-PA1-004 13031-PA1-004	
			length 62.5 comp. height 27.5 +3.5 pin = 17.0 x 62.0	top 1.5 2nd 1.5 oil 4.0 N-SWH30-109/162 R-16007/ 16008 T-32355 13011-673-000 13011-679-621 13011-695-004 13011-PA0-004 13011-PA1-004 13011-PA5-003 13011-PA5-004 13021-PA1-004 13031-PA1-004	
			length 44.7 comp. height 26.2 +2.7 -3.5 pin = 18.0 x 54.0 circlip not required 13101-PWH-000	top 1.0 2nd 1.2 oil 2.0 N- R-16590 T- 13011-REA-Z01 13021-REA-Z01	
			length 62.4 comp. height 27.4 -0.5 pin = 17.0 x 62.0 circlip not required 13101-PA0-000	top 1.5 2nd 1.5 oil 4.0 N-SWH30-109/162 R-16007/ 16008 T-32355 13011-673-000 13011-679-621 13011-695-004 13011-PA0-004 13011-PA1-004 13011-PA5-003 13011-PA5-004 13021-PA1-004 13031-PA1-004	
HONDA L13A4 Bore Dia. 73.0 mm 4 cyl. 1,339 cc FIT / Jazz (02-05) SOHC 8V	KBS97200 skirt MOS2 treated	LB97200 length outside diameter flange diameter flange depth	KB97200 length 44.7 comp. height 26.2 +2.7 -3.5 pin = 18.0 x 54.0 circlip not required 13101-PWH-000	KR97200 top 1.0 2nd 1.2 oil 2.0 N- R-16590 T- 13011-REA-Z01 13021-REA-Z01	
			length 62.5 comp. height 27.5 +3.5 pin = 17.0 x 62.0	top 1.5 2nd 1.5 oil 4.0 N-SWH30-109/162 R-16007/ 16008 T-32355 13011-673-000 13011-679-621 13011-695-004 13011-PA0-004 13011-PA1-004 13011-PA5-003 13011-PA5-004 13021-PA1-004 13031-PA1-004	
			length 44.7 comp. height 26.2 +2.7 -3.5 pin = 18.0 x 54.0 circlip not required 13101-PWH-000	top 1.0 2nd 1.2 oil 2.0 N- R-16590 T- 13011-REA-Z01 13021-REA-Z01	
			length 62.4 comp. height 27.4 -0.5 pin = 17.0 x 62.0 circlip not required 13101-PA0-000	top 1.5 2nd 1.5 oil 4.0 N-SWH30-109/162 R-16007/ 16008 T-32355 13011-673-000 13011-679-621 13011-695-004 13011-PA0-004 13011-PA1-004 13011-PA5-003 13011-PA5-004 13021-PA1-004 13031-PA1-004	

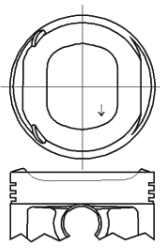
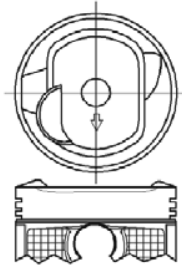
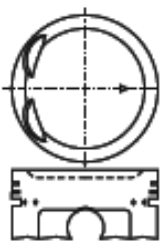

HONDA

MOTOR - TYP	KOLBEN + RINGE PISTON + RINGS PISTONES + ANILLOS	LAUFBUCHSE CYL. SLEEVE CAMISAS	KOLBENSATZ PISTON SET PISTONES KIT	RINGSATZ RING SET ANILLOS	KOLBEN PISTON PISTONES
HONDA L15A6 Bore Dia. 73.0 mm 4 cyl. 1,496 cc CITY ZX (07-) DOHC 16V	KBS97210 skirt MOS2 treated	LB97210 length outside diameter flange diameter flange depth	KB97210 length 47.7 comp. height 26.2 +1.6 -4.0 pin = 18.0 x 54.0 circlip not required	KR97210 top 1.0 2nd 1.2 oil 2.0 N- R-16590 T- 13010-PWC-J01 13020-PWC-J01 13011-REA-Z01 13021-REA-Z01	
			13010-PWC-J01 13020-PWC-J01	13011-REA-Z01 13021-REA-Z01	
			pin = 18.0 x 54.0 circlip not required	N- R-16590 T-	
			13010-PWC-J01 13020-PWC-J01	13011-REA-Z01 13021-REA-Z01	
HONDA L15A6 Bore Dia. 73.0 mm 4 cyl. 1,496 cc CITY (05-08)	KBS97211 skirt MOS2 treated	LB97211 length outside diameter flange diameter flange depth	KB97211 length 44.65 comp. height 26.2 +1.0 -2.6 pin = 18.0 x 54.0 circlip not required	KR97211 top 1.0 2nd 1.2 oil 2.0 N- R-16590 T- 13010-PWB-Y00 13011-REA-Z01 13021-REA-Z01	
			13010-PWB-Y00	13011-REA-Z01 13021-REA-Z01	
			pin = 18.0 x 54.0 circlip not required	N- R-16590 T-	
			13010-PWB-Y00	13011-REA-Z01 13021-REA-Z01	
HONDA EW Bore Dia. 74.0 mm 4 cyl. 1,488 cc CIVIC (84) SOHC 12V	KBS97220	LB97220 length outside diameter flange diameter flange depth	KB97220 length 59.6 comp. height 29.7 -3.5 pin = 19.0 x 56.0 circlip not required	KR97220 top 1.5 2nd 1.5 oil 4.0 N-SWH30-144/186/326 R-16017 / 16024 T-32351 / 32362 13011-657-405 13011-657-670 13011-657-671/3 13011-657-674/5 13011-671-000/4 13011-671-014 13011-PA6-004 13011-PE3-004 13021-PE3-004 13031-PE3-004	
			13011-657-405 13011-657-670 13011-657-671/3 13011-657-674/5 13011-671-000/4 13011-671-014 13011-PA6-004 13011-PE3-004 13021-PE3-004 13031-PE3-004		
			pin = 19.0 x 56.0 circlip not required	N-SWH30-144/186/326 R-16017 / 16024 T-32351 / 32362	
			13011-657-405 13011-657-670 13011-657-671/3 13011-657-674/5 13011-671-000/4 13011-671-014 13011-PA6-004 13011-PE3-004 13021-PE3-004 13031-PE3-004		

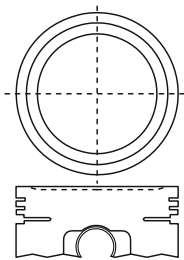
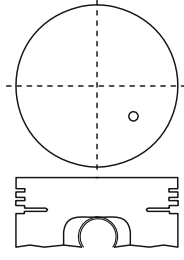
2012 NEW

MOTOR - TYP	KOLBEN + RINGE PISTON + RINGS PISTONES + ANILLOS	LAUFBUCHSE CYL. SLEEVE CAMISAS	KOLBENSATZ PISTON SET PISTONES KIT	RINGSATZ RING SET ANILLOS	KOLBEN PISTON PISTONES	
HONDA ED1 Bore Dia. 74.0 mm 4 cyl. 1,488 cc SOHC 8V	KBS97230	LB97230 length outside diameter flange diameter flange depth	KB97230 length 57.6 comp. height 27.6 -1.4 pin = 17.0 x 66.0 circlip not required 13101-657-020 13101-657-030 13101-663-670	KR97230 top 1.5 2nd 1.5 oil 4.0 N-SWH30-144/186/326 R-16017 / 16024 T-32351 / 32362 13011-657-405 13011-657-670 13011-657-671/3 13011-657-674/5 13011-671-000/4 13011-671-014 13011-PA6-004 13011-PE3-004 13021-PE3-004 13031-PE3-004		
			KB97231 length 57.3 comp. height 27.3 +0 pin = 17.0 x 62.0 circlip not required 13101-657-670	KR97231 top 1.5 2nd 1.5 oil 4.0 N-SWH30-144/186/326 R-16017 / 16024 T-32351 / 32362 13011-657-405 13011-657-670 13011-657-671/3 13011-657-674/5 13011-671-000/4 13011-671-014 13011-PA6-004 13011-PE3-004 13021-PE3-004 13031-PE3-004		
			KB97240 length 57.5 comp. height 27.5 -2.6 pin = 17.0 x 62.0 circlip not required 13101-671-000 13101-671-010	KR97240 top 1.5 2nd 1.5 oil 4.0 N-SWH30-144/186/326 R-16017 / 16024 T-32351 / 32362 13011-657-405 13011-657-670 13011-657-671/3 13011-657-674/5 13011-671-000/4 13011-671-014 13011-PA6-004 13011-PE3-004 13021-PE3-004 13031-PE3-004		
KB97231 length 57.3 comp. height 27.3 +0 pin = 17.0 x 62.0 circlip not required 13101-657-670	KR97231 top 1.5 2nd 1.5 oil 4.0 N-SWH30-144/186/326 R-16017 / 16024 T-32351 / 32362 13011-657-405 13011-657-670 13011-657-671/3 13011-657-674/5 13011-671-000/4 13011-671-014 13011-PA6-004 13011-PE3-004 13021-PE3-004 13031-PE3-004					
KB97240 length 57.5 comp. height 27.5 -2.6 pin = 17.0 x 62.0 circlip not required 13101-671-000 13101-671-010	KR97240 top 1.5 2nd 1.5 oil 4.0 N-SWH30-144/186/326 R-16017 / 16024 T-32351 / 32362 13011-657-405 13011-657-670 13011-657-671/3 13011-657-674/5 13011-671-000/4 13011-671-014 13011-PA6-004 13011-PE3-004 13021-PE3-004 13031-PE3-004					

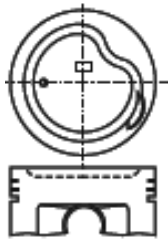
HONDA

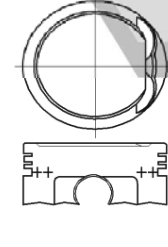
MOTOR - TYP	KOLBEN + RINGE PISTON + RINGS PISTONES + ANILLOS	LAUFBUCHSE CYL. SLEEVE CAMISAS	KOLBENSATZ PISTON SET PISTONES KIT	RINGSATZ RING SET ANILLOS	KOLBEN PISTON PISTONES
HONDA EW (L/R) Bore Dia. 74.0 mm 4 cyl. 1,488 cc CIVIC CRX (84) SOHC 8V	KBS97250	LB97250 length outside diameter flange diameter flange depth	KB97250 length 59.7 comp. 29.7 height -4.6 pin = 19.0 x 56.0 circlip not required 13101-PE1-000	KR97250 top 1.2 2nd 1.2 oil 2.8 N-SWH30-253/364 R-16018/ 16023 T-32364 13011-PA6-014 13011-PE1-004 13011-PE7-014	
			pin = 19.0 x 56.0 circlip not required 13101-PE1-000	N-SWH30-253/364 R-16018/ 16023 T-32364 13011-PA6-014 13011-PE1-004 13011-PE7-014	
HONDA D15A3 EW4 Bore Dia. 74.0 mm 4 cyl. 1,488 cc SOHC 8V	KBS97260	LB97260 length outside diameter flange diameter flange depth	KB97260 length 59.8 comp. 29.7 height -5.2 pin = 19.0 x 56.0 circlip not required 13101-PE4-730	KR97260 top 1.5 2nd 1.5 oil 4.0 N-SWH30-144/186/326 R-16017 / 16024 T-32351 / 32362 13011-657-405 13011-657-670 13011-657-671/3 13011-657-674/5 13011-671-000/4 13011-671-014 13011-PA6-004 13011-PE3-004 13021-PE3-004 13031-PE3-004	
			pin = 19.0 x 56.0 circlip not required 13101-PE4-730	N-SWH30-144/186/326 R-16017 / 16024 T-32351 / 32362 13011-657-405 13011-657-670 13011-657-671/3 13011-657-674/5 13011-671-000/4 13011-671-014 13011-PA6-004 13011-PE3-004 13021-PE3-004 13031-PE3-004	
HONDA EV Bore Dia. 74.0 mm 4 cyl. 1,342 cc CIVIC (84) SOHC 12V	KBS97270	LB97270 length outside diameter flange diameter flange depth	KB97270 length 60.0 comp. 30.0 height -1.5 pin = 19.0 x 56.0 circlip not required 13101-PE3-000 13102-PE3-000 13103-PE3-000	KR97270 top 1.5 2nd 1.5 oil 4.0 N-SWH30-144/186/326 R-16017 / 16024 T-32351 / 32362 13011-657-405 13011-657-670 13011-657-671/3 13011-657-674/5 13011-671-000/4 13011-671-014 13011-PA6-004 13011-PE3-004 13021-PE3-004 13031-PE3-004	
			pin = 19.0 x 56.0 circlip not required 13101-PE3-000 13102-PE3-000 13103-PE3-000	N-SWH30-144/186/326 R-16017 / 16024 T-32351 / 32362 13011-657-405 13011-657-670 13011-657-671/3 13011-657-674/5 13011-671-000/4 13011-671-014 13011-PA6-004 13011-PE3-004 13021-PE3-004 13031-PE3-004	

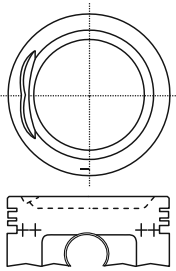
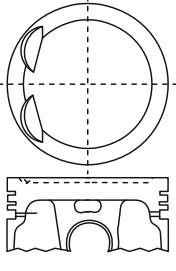
MOTOR - TYP	KOLBEN + RINGE PISTON + RINGS PISTONES + ANILLOS	LAUFBUCHSE CYL. SLEEVE CAMISAS	KOLBENSATZ PISTON SET PISTONES KIT	RINGSATZ RING SET ANILLOS	KOLBEN PISTON PISTONES	
HONDA EV Bore Dia. 74.0 mm 4 cyl. 1,342 cc CIVIC (84) SOHC 12V	KBS97271	LB97271 length outside diameter flange diameter flange depth	KB97271 length 60.0 comp. height 30.0 -0.7 pin = 19.0 x 56.0 circlip not required 13101-PE5-000 13102-PE5-000	KR97271 top 1.5 2nd 1.5 oil 4.0 N-SWH30-144/186/326 R-16017 / 16024 T-32351 / 32362 13011-657-405 13011-657-670 13011-657-671/3 13011-657-674/5 13011-671-000/4 13011-671-014 13011-PA6-004 13011-PE3-004 13021-PE3-004 13031-PE3-004		
			KB97272 length 59.8 comp. height 29.8 -2.7 pin = 19.0 x 56.0 circlip not required 13101-PE7-000 13102-PE7-000 13103-PE7-000	KR97272 top 1.5 2nd 1.5 oil 4.0 N-SWH30-144/186/326 R-16017 / 16024 T-32351 / 32362 13011-657-405 13011-657-670 13011-657-671/3 13011-657-674/5 13011-671-000/4 13011-671-014 13011-PA6-004 13011-PE3-004 13021-PE3-004 13031-PE3-004		
			KB97280 length 62.7 comp. height 27.7 +0 pin = 17.0 x 62.0 circlip not required 13101-PA6-000 13101-PA6-305	KR97280 top 1.5 2nd 1.5 oil 4.0 N-SWH30-144/186/326 R-16017 / 16024 T-32351 / 32362 13011-657-405 13011-657-670 13011-657-671/3 13011-657-674/5 13011-671-000/4 13011-671-014 13011-PA6-004 13011-PE3-004 13021-PE3-004 13031-PE3-004		

HONDA

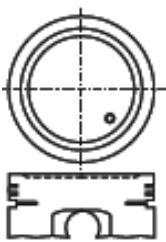
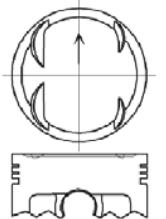
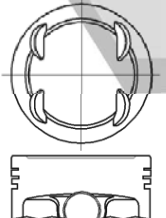
MOTOR - TYP	KOLBEN + RINGE PISTON + RINGS PISTONES + ANILLOS	LAUFBUCHSE CYL. SLEEVE CAMISAS	KOLBENSATZ PISTON SET PISTONES KIT	RINGSATZ RING SET ANILLOS	KOLBEN PISTON PISTONES
HONDA ED3 ED4 Bore Dia. 74.0 mm 4 cyl. 1,488 cc SOHC 8V	KBS97290	LB97290 length outside diameter flange diameter flange depth	KB97290 length 57.3 comp. height 27.3 -1.4 pin = 17.0 x 62.0	KR97290 top 1.5 2nd 1.5 oil 4.0 N-SWH30-144/186/326 R-16017 / 16024 T-32351 / 32362 13011-657-405 13011-657-670 13011-657-671/3 13011-657-674/5 13011-671-000/4 13011-671-014 13011-PA6-004 13011-PE3-004 13021-PE3-004 13031-PE3-004	
			length 51.0 comp. height 31.0 -1.0 -3.2 pin = 19.0 x 55.0 circlip not required 13010-P3R-T00 13020-P2A-000 13030-P2A-000	top 1.2 2nd 1.5 oil 2.8 N-SWH30-365/372 R-16240/ 16365 T- 13011-PJ1-752 13011-PM1-004 13011-PM3-004 13011-PM5-A02 13011-PO4-G02	
			length 59.5 outside diameter flange diameter flange depth	top 1.2 2nd 1.5 oil 2.8 N-SWH30-362 R-16161 T-32376 13101-PM6-K00 13011-PG6-004 13011-PM6-G02 13021-PG6-004 13031-PG6-004	
HONDA D13 Bore Dia. 75.0 mm 4 cyl. 1,343 cc CIVIC DX (88-95)	KBS97300	LB97300 length outside diameter flange diameter flange depth	KB97300 length 51.0 comp. height 31.0 -1.0 -3.2 pin = 19.0 x 55.0 circlip not required 13010-P3R-T00 13020-P2A-000 13030-P2A-000	KR97300 top 1.2 2nd 1.5 oil 2.8 N-SWH30-365/372 R-16240/ 16365 T- 13011-PJ1-752 13011-PM1-004 13011-PM3-004 13011-PM5-A02 13011-PO4-G02	
			length 59.5 outside diameter flange diameter flange depth	top 1.2 2nd 1.5 oil 2.8 N-SWH30-362 R-16161 T-32376 13101-PM6-K00 13011-PG6-004 13011-PM6-G02 13021-PG6-004 13031-PG6-004	
			length 59.5 outside diameter flange diameter flange depth	top 1.2 2nd 1.5 oil 2.8 N-SWH30-362 R-16161 T-32376 13101-PM6-K00 13011-PG6-004 13011-PM6-G02 13021-PG6-004 13031-PG6-004	
HONDA D16A Bore Dia. 75.0 mm 4 cyl. 1,590 cc CIVIC	KBS97310	LB97310 length outside diameter flange diameter flange depth	KB97310 length 59.5 comp. height 29.5 -1.0 pin = 19.0 x 54.0 circlip not required 13101-PM6-K00	KR97310 top 1.2 2nd 1.5 oil 2.8 N-SWH30-362 R-16161 T-32376 13101-PM6-K00 13011-PG6-004 13011-PM6-G02 13021-PG6-004 13031-PG6-004	
			length 59.5 outside diameter flange diameter flange depth	top 1.2 2nd 1.5 oil 2.8 N-SWH30-362 R-16161 T-32376 13101-PM6-K00 13011-PG6-004 13011-PM6-G02 13021-PG6-004 13031-PG6-004	
			length 59.5 outside diameter flange diameter flange depth	top 1.2 2nd 1.5 oil 2.8 N-SWH30-362 R-16161 T-32376 13101-PM6-K00 13011-PG6-004 13011-PM6-G02 13021-PG6-004 13031-PG6-004	

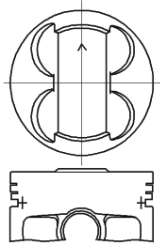
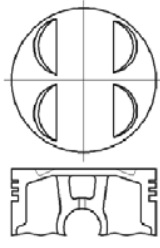
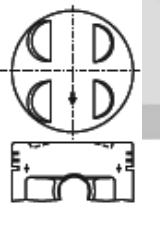
MOTOR - TYP	KOLBEN + RINGE PISTON + RINGS PISTONES + ANILLOS	LAUFBUCHSE CYL. SLEEVE CAMISAS	KOLBENSATZ PISTON SET PISTONES KIT	RINGSATZ RING SET ANILLOS	KOLBEN PISTON PISTONES
HONDA Bore Dia. 75.0 mm 4 cyl. 1,493 cc CIVIC 16V	KBS97320	LB97320 length outside diameter flange diameter flange depth	length 61.8 comp. height 30.8 +1.0	top 1.2 2nd 1.5 oil 4.0	
			pin = 19.0 x 56.0 circlip not required	N-SWH30-382 R-16151 T-32375	
			13101-PM3-K00	13011-PMO-B01 13011-PMO-B02 13011-PMO-B03 13021-PMO-B02 13021-PMO-B03 13031-PMO-B02 13031-PMO-B03	
HONDA D15B1 D15B2 Bore Dia. 75.0 mm 4 cyl. 1,493 cc SOHC 16V	KBS97330	LB97330 length outside diameter flange diameter flange depth	length 60.8 comp. height 30.8 -4.0	top 1.2 2nd 1.5 oil 2.8	
			pin = 19.0 x 56.0 circlip not required	N-SWH30-365/372 R-16240/ 16365 T-	
			13101-PM3-000 13101-PM3-010 13101-PM3-020	13011-PJ1-752 13011-PM1-004 13011-PM3-004 13011-PM5-A02 13011-PO4-G02	
HONDA D15B Bore Dia. 75.0 mm 4 cyl. 1,493 cc SOHC 16V	KBS97340	LB97340 length outside diameter flange diameter flange depth	length 60.8 comp. height 30.7 -4.0	top 1.2 2nd 1.5 oil 2.8	
			pin = 19.0 x 56.0 circlip not required	N-SWH30-365/372 R-16240/ 16365 T-	
			13101-PO2-101 13101-PM3-PO1	13011-PJ1-752 13011-PM1-004 13011-PM3-004 13011-PM5-A02 13011-PO4-G02	

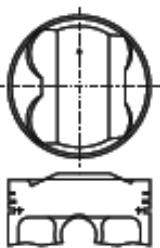
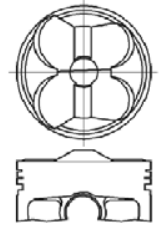
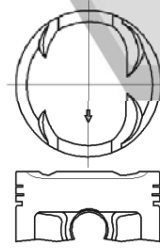

HONDA

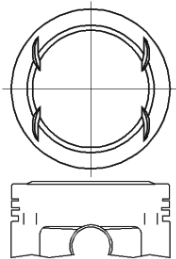
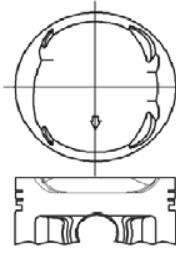
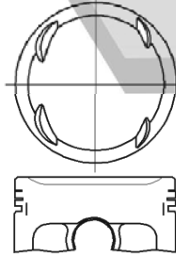
MOTOR - TYP	KOLBEN + RINGE PISTON + RINGS PISTONES + ANILLOS	LAUFBUCHSE CYL. SLEEVE CAMISAS	KOLBENSATZ PISTON SET PISTONES KIT	RINGSATZ RING SET ANILLOS	KOLBEN PISTON PISTONES
HONDA D16A Bore Dia. 75.0 mm 4 cyl. 1,590 cc CIVIC	KBS97350	LB97350 length outside diameter flange diameter flange depth	length 62.6 comp. height 29.0 +3.6	top 1.2 2nd 1.5 oil 2.8	
			pin = 19.0 x 56.0 circlip not required	N-SWH30-362 R-16161 T-32376	
			13101-P29-000 13101-PM7-000 13101-PM7-010	13011-PG6-004 13011-PM6-G02 13021-PG6-004 13031-PG6-004	
HONDA Civic 1.5 Bore Dia. 75.0 mm 4 cyl. 1,493 cc CIVIC	KBS97360	LB97360 length outside diameter flange diameter flange depth	length 53.1 comp. height 29.5 +6.3	top 1.2 2nd 1.5 oil 4.0	
			pin = 19.0 x 48.0 circlip required	N-SWH30-382 R-16151 T-32375	
				13011-PMO-B01 13011-PMO-B02 13011-PMO-B03 13021-PMO-B02 13021-PMO-B03 13031-PMO-B02 13031-PMO-B03	
HONDA D16Z6 Bore Dia. 75.0 mm 4 cyl. 1,590 cc CIVIC SOHC 16V	KBS88000	LB88000 length outside diameter flange diameter flange depth	length 60.0 comp. height 30.0 -3.5	top 1.2 2nd 1.5 oil 2.8	
			pin = 19.0 x 56.0 circlip not required	N- R-16261 T-	
			13010-P28-A01 13101-P28-A01	13011-P28-A02	

MOTOR - TYP	KOLBEN + RINGE PISTON + RINGS PISTONES + ANILLOS	LAUFBUCHSE CYL. SLEEVE CAMISAS	KOLBENSATZ PISTON SET PISTONES KIT	RINGSATZ RING SET ANILLOS	KOLBEN PISTON PISTONES
HONDA D16A Bore Dia. 75.0 mm 4 cyl. 1,590 cc INTEGRA (86-87) DOHC 16V	KBS88010	LB88010 length outside diameter flange diameter flange depth	KB88010 length 60.7 comp. height 30.0 +0.7 pin = 19.0 x 56.0 circlip not required 13101-PG6-000 13101-PR3-003 13102-PG6-000 13013-PG6-000	KR88010 top 1.2 2nd 1.5 oil 2.8 N-SWH30-362 R-16161 T-32376 13011-PG6-004 13011-PM6-G02 13021-PG6-004 13031-PG6-004	
			13101-PG6-000 13101-PR3-003 13102-PG6-000 13013-PG6-000	13011-PG6-004 13011-PM6-G02 13021-PG6-004 13031-PG6-004	
HONDA D15Z1 Bore Dia. 75.0 mm 4 cyl. 1,493 cc CIVIC SOHC 16V	KBS88020	LB88020 length outside diameter flange diameter flange depth	KB88020 length 57.7 comp. height 27.7 -7.2 pin = 19.0 x 56.0 circlip not required 13010-P07-000 13010-P07-010 13101-P07-000 13101-P07-010	KR88020 top 1.0 2nd 1.2 oil 2.8 N-SWH30-423 R-16010/ 16242 16243 T-32381 13011-P07-004 13011-P08-004 13011-PJ1-Y01	
			13010-P07-000 13010-P07-010 13101-P07-000 13101-P07-010	13011-P07-004 13011-P08-004 13011-PJ1-Y01	
HONDA D16Y7 Bore Dia. 75.0 mm 4 cyl. 1,590 cc CIVIC SOHC 16V	KBS88030	LB88030 length outside diameter flange diameter flange depth	KB88030 length 50.0 comp. height 30.0 -3.4 pin = 19.0 x 56.0 circlip not required 13010-P2E-000 13101-P2E-000	KR88030 top 1.0 2nd 1.2 oil 2.8 N-SWH30-423 R-16010/ 16242 16243 T-32381 13011-P07-004 13011-P08-004 13011-PJ1-Y01	
			13010-P2E-000 13101-P2E-000	13011-P07-004 13011-P08-004 13011-PJ1-Y01	

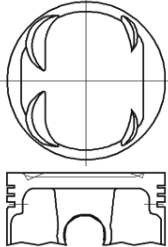
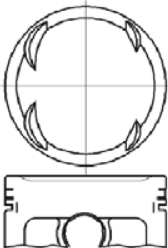
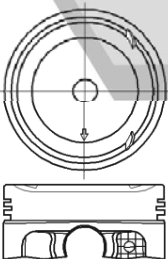
HONDA

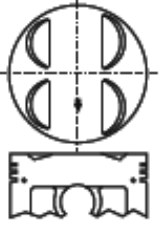
MOTOR - TYP	KOLBEN + RINGE PISTON + RINGS PISTONES + ANILLOS	LAUFBUCHSE CYL. SLEEVE CAMISAS	KOLBENSATZ PISTON SET PISTONES KIT	RINGSATZ RING SET ANILLOS	KOLBEN PISTON PISTONES
HONDA D16Y8 Bore Dia. 75.0 mm 4 cyl. 1,590 cc CIVIC SOHC 16V	KBS88040	LB88040 length outside diameter flange diameter flange depth	length 49.2 comp. height 29.2 -2.1	top 1.0 2nd 1.2 oil 2.8	
			pin = 19.0 x 56.0 circlip not required	N-SWH30-423 R-16010/ 16242 16243 T-32381	
			13101-P2P-000	13011-P07-004 13011-P08-004 13011-PJ1-Y01	
HONDA City 1.5 Bore Dia. 75.0 mm 4 cyl. 1,493 cc CIVIC	KBS88050	LB88050 length outside diameter flange diameter flange depth	length 47.8 comp. height 27.8 -2.2	top 1.0 2nd 1.2 oil 2.8	
			pin = 19.0 x 56.0 circlip not required	N-SWH30-423 R-16010/ 16242 16243 T-32381	
				13011-P07-004 13011-P08-004 13011-PJ1-Y01	
HONDA D17A1 Bore Dia. 75.0 mm 4 cyl. 1,668 cc CIVIC SOHC 16V	KBS88060	LB88060 length outside diameter flange diameter flange depth	length 46.4 comp. height 26.9 -3.0	top 1.0 2nd 1.2 oil 2.0	
			pin = 19.0 x 56.0 circlip not required	N-SWH30-440 R-16040 T-32400	
			13010-PLM-A00 13020-PLM-A00 13030-PLM-A00	13011-PLM-A00 13011-PLR-004 13011-PLR-A00 13011-PLK-004	

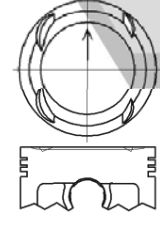

MOTOR - TYP	KOLBEN + RINGE PISTON + RINGS PISTONES + ANILLOS	LAUFBUCHSE CYL. SLEEVE CAMISAS	KOLBENSATZ PISTON SET PISTONES KIT	RINGSATZ RING SET ANILLOS	KOLBEN PISTON PISTONES
HONDA D13B D15B Bore Dia. 75.0 mm 4 cyl. 1,493 cc CIVIC SOHC 16V	KBS88070	LB88070 length outside diameter flange diameter flange depth	KB88070	KR88070	
			length 60.8 comp. height 30.8 -4.2	top 1.2 2nd 1.5 oil 4.0	
			pin = 19.0 x 56.0 circlip not required	N-SWH30-382 R-16151 T-32375	
			13101-PM3-P00 13101-PM3-P02	13101-PMO-B01 13101-PMO-B02 13101-PMO-B03 13021-PMO-B02 13021-PMO-B03 13031-PMO-B02 13031-PMO-B03	
HONDA D17A2 Bore Dia. 75.0 mm 4 cyl. 1,668 cc CIVIC SOHC 16V	KBS88080	LB88080 length outside diameter flange diameter flange depth	KB88080	KR88080	
			length 46.4 comp. height 26.9 -0.8 -2.6	top 1.0 2nd 1.2 oil 2.0	
			pin = 19.0 x 56.0 circlip not required	N-SWH30-440 R-16040 T-32400	
			13010-PLR-A00 13020-PLR-A00 13030-PLR-A00	13011-PLM-A00 13011-PLR-004 13011-PLR-A00 13011-PLK-004	
HONDA D15 Bore Dia. 75.0 mm 4 cyl. 1,493 cc CIVIC	KBS88090	LB88090 length outside diameter flange diameter flange depth	KB88090	KR88090	
			length 47.8 comp. height 27.8 -3.1 -3.3	top 1.2 2nd 1.5 oil 2.8	
			pin = 19.0 x 56.0 circlip not required	N-SWH30-365/372 R-16240/ 16365 T-	
			13010-P2C-Y00	13011-PJ1-752 13011-PM1-004 13011-PM3-004 13011-PM5-A02	

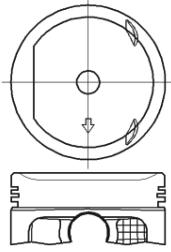
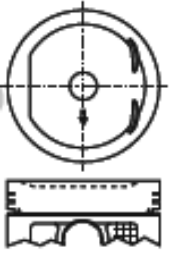
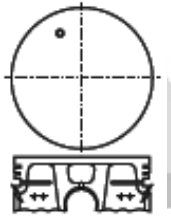
HONDA

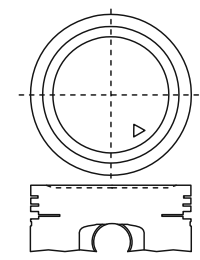
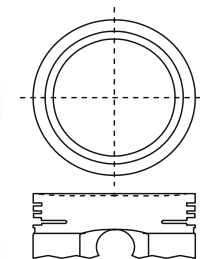
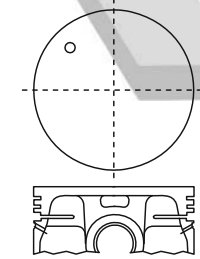
MOTOR - TYP	KOLBEN + RINGE PISTON + RINGS PISTONES + ANILLOS	LAUFBUCHSE CYL. SLEEVE CAMISAS	KOLBENSATZ PISTON SET PISTONES KIT	RINGSATZ RING SET ANILLOS	KOLBEN PISTON PISTONES
HONDA CIVIC EXI Bore Dia. 75.0 mm 4 cyl. cc	KBS88100	LB88100 length outside diameter flange diameter flange depth	KB88100 length 46.4 comp. height 26.8 -2.8	KR88100 top 1.0 2nd 1.2 oil 2.8	
			pin = 19.0 x 56.0 circlip not required	N-SWH30-423 R-16010/ 16242 16243 T-32381	
			13010-PLC-Y00 13101-PLC-Y00	13011-P07-004 13011-P08-004 13011-PJ1-Y01	
			2012 NEW		
HONDA CIVIC VTI Bore Dia. 75.0 mm 4 cyl. 1,668 cc SOHC 16V	KBS88110	LB88110 length outside diameter flange diameter flange depth	KB88110 length 48.8 comp. height 29.2 -3.3	KR88110 top 1.0 2nd 1.2 oil 2.8	
			pin = 19.0 x 56.0 circlip not required	N-SWH30-423 R-16010/ 16242 16243 T-32381	
			13010-PLL-Y00 13101-PLL-Y00	13011-P07-004 13011-P08-004 13011-PJ1-Y01	
			2012 NEW		
HONDA EK1 Bore Dia. 77.0 mm 4 cyl. 1,750 cc ACCORD SOHC 8V	KBS88120	LB88120 length outside diameter flange diameter flange depth	KB88120 length 62.2 comp. height 27.7 +0	KR88120 top 1.5 2nd 1.5 oil 4.0	
			pin = 18.0 x 67.0 circlip not required	N-SWH30-158/183 R-16025/ 16026 T-32357	
			13101-676-601	13011-676-601/602 13011-676-604/642 13011-689-003/005 13011-689-013/015 13011-PB1-003 13011-PB2-005 13011-PC3-601/2/3 13011-PC4-601 13021-676-602 13021-PC3-601	
			2012 NEW		

MOTOR - TYP	KOLBEN + RINGE PISTON + RINGS PISTONES + ANILLOS	LAUFBUCHSE CYL. SLEEVE CAMISAS	KOLBENSATZ PISTON SET PISTONES KIT	RINGSATZ RING SET ANILLOS	KOLBEN PISTON PISTONES
HONDA ED EK1 Bore Dia. 77.0 mm 4 cyl. 1,750 cc	KBS88130	LB88130	KB88130	KR88130	
ACCORD SOHC 8V		outside diameter	comp. height 27.5 -1.3	2nd 1.5 oil 4.0	
		flange depth	13101-689-000	13011-676-601/602 13011-676-604/642 13011-689-003/005 13011-689-013/015 13011-PB1-003 13011-PB2-005 13011-PC3-601/2/3 13011-PC4-601 13021-676-602 13021-PC3-601	
HONDA ED EK1 Bore Dia. 77.0 mm 4 cyl. 1,750 cc	KBS88131	LB88131	KB88131	KR88131	
ACCORD SOHC 8V		outside diameter	comp. height 27.5 -1.1	2nd 1.5 oil 4.0	
		flange depth	13101-689-010	13011-676-601/602 13011-676-604/642 13011-689-003/005 13011-689-013/015 13011-PB1-003 13011-PB2-005 13011-PC3-601/2/3 13011-PC4-601 13021-676-602 13021-PC3-601	
HONDA EK Bore Dia. 77.0 mm 4 cyl. 1,750 cc	KBS88140	LB88140	KB88140	KR88140	
ACCORD SOHC 8V		outside diameter	comp. height 27.5 +0	2nd 1.5 oil 4.0	
		flange depth	13101-PB1-000	13011-676-601/602 13011-676-604/642 13011-689-003/005 13011-689-013/015 13011-PB1-003 13011-PB2-005 13011-PC3-601/2/3 13011-PC4-601 13021-676-602 13021-PC3-601	

HONDA

MOTOR - TYP	KOLBEN + RINGE PISTON + RINGS PISTONES + ANILLOS	LAUFBUCHSE CYL. SLEEVE CAMISAS	KOLBENSATZ PISTON SET PISTONES KIT	RINGSATZ RING SET ANILLOS	KOLBEN PISTON PISTONES
HONDA EK1 Bore Dia. 77.0 mm 4 cyl. 1,750 cc ACCORD SOHC 8V	KBS88150	LB88150 length outside diameter flange diameter flange depth	KB88150 length 62.5 comp. height 27.5 -1.7 pin = 18.0 x 67.0 circlip not required	KR88150 top 1.5 2nd 1.5 oil 4.0 N-SWH30-158/183 R-16025/ 16026 T-32357	
			13101-PB2-000 13101-PB2-010 13101-PB2-900	13011-676-601/602 13011-676-604/642 13011-689-003/005 13011-689-013/015 13011-PB1-003 13011-PB2-005 13011-PC3-601/2/3 13011-PC4-601 13021-676-602 13021-PC3-601	
HONDA EP Bore Dia. 77.0 mm 4 cyl. 1,601 cc ACCORD (83-) SOHC 8V	KBS88160	LB88160 length outside diameter flange diameter flange depth	KB88160 length 62.5 comp. height 28.0 +0 pin = 18.0 x 62.0 circlip not required	KR88160 top 1.5 2nd 1.5 oil 4.0 N-SWH30-158/183 R-16025/ 16026 T-32357	
			13101-PC1-000 13101-PC1-010 13101-PC3-600 13102-PC3-600	13011-676-601/602 13011-676-604/642 13011-689-003/005 13011-689-013/015 13011-PB1-003 13011-PB2-005 13011-PC3-601/2/3 13011-PC4-601 13021-676-602 13021-PC3-601	
HONDA ES Bore Dia. 80.0 mm 4 cyl. 1,829 cc PRELUDE SOHC 12V	KBS88170	LB88170 length outside diameter flange diameter flange depth	KB88170 length 65.5 comp. height 30.0 -3.0 pin = 20.0 x 62.0 circlip not required	KR88170 top 1.5 2nd 1.5 oil 4.0 N-SWH30-251 R-16027/ 16028 16029 T-32360	
			13101-PC6-000 13101-PC6-900	13011-PC6-004 13011-PC6-013 13011-PC7-004 13011-PC7-023 13011-PD6-003 13011-PD6-004 13011-PH1-003 13011-PH2-003 13021-PC7-004/023 13031-PC7-004/023	

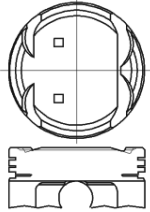
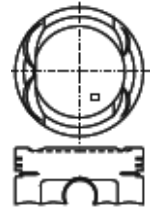
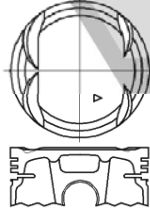
MOTOR - TYP	KOLBEN + RINGE PISTON + RINGS PISTONES + ANILLOS	LAUFBUCHSE CYL. SLEEVE CAMISAS	KOLBENSATZ PISTON SET PISTONES KIT	RINGSATZ RING SET ANILLOS	KOLBEN PISTON PISTONES
HONDA ET ET2 Bore Dia. 80.0 mm 4 cyl. 1,829 cc	KBS88180	LB88180	KB88180	KR88180	
ACCORD SOHC 12V		length outside diameter flange diameter flange depth			
HONDA ES Bore Dia. 80.0 mm 4 cyl. 1,829 cc	KBS88190	LB88190	KB88190	KR88190	
PRELUDE (83-) SOHC 12V		length outside diameter flange diameter flange depth			
HONDA ES Bore Dia. 80.0 mm 4 cyl. 1,829 cc	KBS88191	LB88191	KB88191	KR88191	
ACCORD (84-) SOHC 12V		length outside diameter flange diameter flange depth			

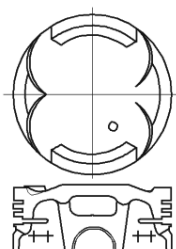
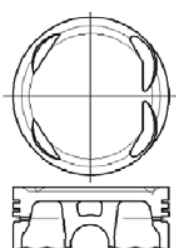
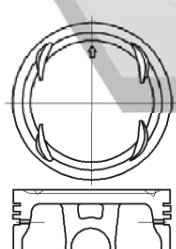

HONDA

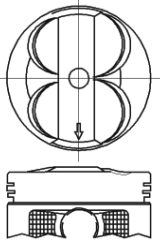
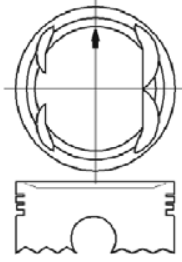
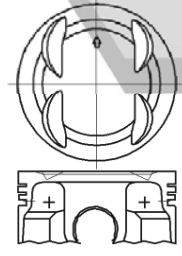
MOTOR - TYP	KOLBEN + RINGE PISTON + RINGS PISTONES + ANILLOS	LAUFBUCHSE CYL. SLEEVE CAMISAS	KOLBENSATZ PISTON SET PISTONES KIT	RINGSATZ RING SET ANILLOS	KOLBEN PISTON PISTONES
HONDA ES Bore Dia. 80.0 mm 4 cyl. 1,829 cc ACCORD (84-) SOHC 12V	KBS88192	LB88192 length outside diameter flange diameter flange depth	KB88192 length 66.9 comp. height 29.8 +1.4 pin = 20.0 x 62.0 circlip not required	KR88192 top 1.5 2nd 1.5 oil 4.0	
			13101-PD5-000 13101-PD5-010 13102-PD5-000 13103-PD5-010 13105-PD5-010	N-SWH30-251 R-16027/ 16028 16029 T-32360 13011-PC6-004 13011-PC6-013 13011-PC7-004 13011-PC7-023 13011-PD6-003 13011-PD6-004 13011-PH1-003 13011-PH2-003 13021-PC7-004/023 13031-PC7-004/023	
HONDA B20A3 Bore Dia. 81.0 mm 4 cyl. 1,958 cc ACCORD SOHC 12V	KBS88200	LB88200 length outside diameter flange diameter flange depth	KB88200 length 65.2 comp. height 29.8 -2.0 pin = 20.0 x 62.0 circlip not required	KR88200 top 1.2 2nd 1.5 oil 2.8	
			13101-PK1-000 13101-PK1-010	N-SWH30-375/396 R-16031/ 16039 16091 T-32368 13011-PJ5-601 13011-PJ5-602 13011-PH3-003 13011-PH3-004 13011-PH3-901 13011-PH5-003 13011-PK1-003 13011-PK1-004 13011-PK1-751 13011-PK1-752	
HONDA B20A5 Bore Dia. 81.0 mm 4 cyl. 1,958 cc PRELUDE (88-89) DOHC 16V	KBS88210	LB88210 length outside diameter flange diameter flange depth	KB88210 length 65.4 comp. height 30.8 -2.1 pin = 22.0 x 57.0 circlip not required	KR88210 top 1.2 2nd 1.5 oil 2.8	
			13101-PK2-660 13101-PK2-662 13102-PK2-660 13103-PK2-660 13105-PK2-660	N-SWH30-375/396 R-16031/ 16039 16091 T-32368 13011-PJ5-601 13011-PJ5-602 13011-PH3-003 13011-PH3-004 13011-PH3-901 13011-PH5-003 13011-PK1-003 13011-PK1-004 13011-PK1-751 13011-PK1-752	

MOTOR - TYP	KOLBEN + RINGE PISTON + RINGS PISTONES + ANILLOS	LAUFBUCHSE CYL. SLEEVE CAMISAS	KOLBENSATZ PISTON SET PISTONES KIT	RINGSATZ RING SET ANILLOS	KOLBEN PISTON PISTONES
HONDA B16A2 Bore Dia. 81.0 mm 4 cyl. 1,595 cc CIVIC CRX (92-) DOHC 16V	KBS94000 skirt MOS2 treated	LB94000 length outside diameter flange diameter flange depth	KB94000 length 59.9 comp. height 29.9 +2.7 pin = 21.0 x 56.5 circlip not required 13010-P30-G00 13020-P30-G00	KR94000 top 1.0 2nd 1.2 oil 2.8 N-SWH30-373 R-16033/ 16034 T-32391 13011-PR3-003 13011-PR3-004 13011-PR4-A01 13011-PR4-A02 13011-PR4-Y02 13021-PR3-003 13021-PR3-004 13021-PR4-Y02	
			13011-PR3-003 13011-PR3-004 13011-PR4-A01 13011-PR4-A02 13011-PR4-Y02 13021-PR3-003 13021-PR3-004 13021-PR4-Y02		
HONDA B18A1 Bore Dia. 81.0 mm 4 cyl. 1,834 cc INTEGRA (92-93) DOHC 16V	KBS88230	LB88230 length outside diameter flange diameter flange depth	KB88230 length 60.0 comp. height 30.0 -1.5 pin = 21.0 x 56.5 circlip not required 13101-PR4-000 13102-PR4-000	KR88230 top 1.0 2nd 1.2 oil 2.8 N-SWH30-373 R-16033/ 16034 T-32391 13011-PR3-003 13011-PR3-004 13011-PR4-A01 13011-PR4-A02 13011-PR4-Y02 13021-PR3-003 13021-PR3-004 13021-PR4-Y02	
			13011-PR3-003 13011-PR3-004 13011-PR4-A01 13011-PR4-A02 13011-PR4-Y02 13021-PR3-003 13021-PR3-004 13021-PR4-Y02		
HONDA B18B1 Bore Dia. 81.0 mm 4 cyl. 1,834 cc INTEGRA DOHC 16V	KBS88240	LB88240 length outside diameter flange diameter flange depth	KB88240 length 60.0 comp. height 30.0 -1.3 pin = 21.0 x 56.0 circlip not required 13101-P54-000 13101-P54-A00	KR88240 top 1.0 2nd 1.2 oil 2.8 N-SWH30-373 R-16033/ 16034 T-32391 13011-PR3-003 13011-PR3-004 13011-PR4-A01 13011-PR4-A02 13011-PR4-Y02 13021-PR3-003 13021-PR3-004 13021-PR4-Y02	
			13011-PR3-003 13011-PR3-004 13011-PR4-A01 13011-PR4-A02 13011-PR4-Y02 13021-PR3-003 13021-PR3-004 13021-PR4-Y02		

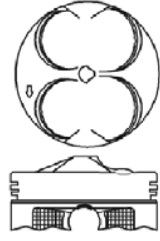
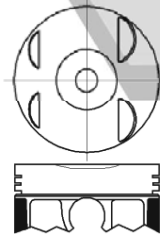
HONDA

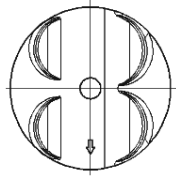
MOTOR - TYP	KOLBEN + RINGE PISTON + RINGS PISTONES + ANILLOS	LAUFBUCHSE CYL. SLEEVE CAMISAS	KOLBENSATZ PISTON SET PISTONES KIT	RINGSATZ RING SET ANILLOS	KOLBEN PISTON PISTONES
HONDA B18C5 Bore Dia. 81.0 mm 4 cyl. 1,834 cc	KBS88250 skirt MOS2 treated	LB88250 length outside diameter flange diameter flange depth	KB88250 length 60.3 comp. height 30.3 +1.8	KR88250 top 1.0 2nd 1.2 oil 2.8	
			pin = 21.0 x 56.4 circlip not required 13010-P73-A00 13020-P73-A00 13101-P73-A00	N-SWH30-373 R-16033/ 16034 T-32391 13011-PR3-003 13011-PR3-004 13011-PR4-A01 13011-PR4-A02 13011-PR4-Y02 13021-PR3-003 13021-PR3-004 13021-PR4-Y02	
INTEGRA DOHC 16V					
HONDA B16B Bore Dia. 81.0 mm 4 cyl. 1,595 cc	KBS88260 skirt MOS2 treated	LB88260 length outside diameter flange diameter flange depth	KB88260 length 67.0 comp. height 30.4 +6.6	KR88260 top 1.0 2nd 1.2 oil 2.8	
			pin = 21.0 x 56.5 circlip not required 13010-PCT-000 13020-PCT-000	N-SWH30-373 R-16033/ 16034 T-32391 13011-PR3-003 13011-PR3-004 13011-PR4-A01 13011-PR4-A02 13011-PR4-Y02 13021-PR3-003 13021-PR3-004 13021-PR4-Y02	
CIVIC TYPE-R (97-00) DOHC 16V					
HONDA R18A1 R18A2 Bore Dia. 81.0 mm 4 cyl. 1,799 cc	KBS88270 skirt MOS2 treated	LB88270 length outside diameter flange diameter flange depth	KB88270 length 49.4 comp. height 28.9 -1.1 -2.0	KR88270 top 1.2 2nd 1.2 oil 2.0	
			pin = 20.0 x 46.0 circlip required 13010-RNA-A00 13020-RNA-A00	N-R-T- 13011-RNA-A01 13011-RNA-A02 13011-RNB-A01 13021-RNA-A01 13021-RNA-A02	
CIVIC FR-V (06-09) SOHC 16V					

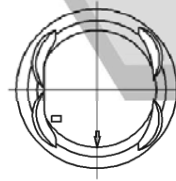
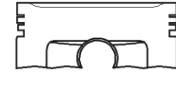



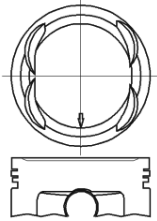
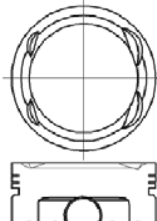
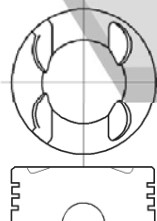

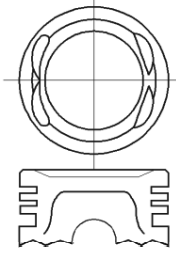
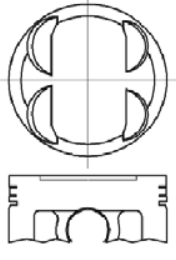
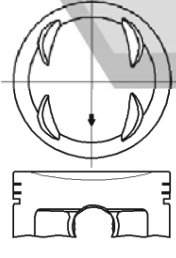
MOTOR - TYP	KOLBEN + RINGE PISTON + RINGS PISTONES + ANILLOS	LAUFBUCHSE CYL. SLEEVE CAMISAS	KOLBENSATZ PISTON SET PISTONES KIT	RINGSATZ RING SET ANILLOS	KOLBEN PISTON PISTONES
HONDA B18C1 Bore Dia. 81.0 mm 4 cyl. 1,797 cc INTEGRA DOHC	KBS88280	LB88280 length outside diameter flange diameter flange depth	KB88280 length 60.1 comp. height 30.1 -3.3 -5.1	KR88280 top 1.0 2nd 1.2 oil 2.8	
			pin = 21.0 x 56.5 circlip not required 13010-P72-A00 13020-P72-A00	N-SWH30-373 R-16033/ 16034 T-32391 13011-PR3-003 13011-PR3-004 13011-PR4-A01 13011-PR4-A02 13011-PR4-Y02 13021-PR3-003 13021-PR3-004 13021-PR4-Y02	
2012 NEW					
HONDA R18 Bore Dia. 81.0 mm 4 cyl. 1,799 cc SOHC 16V	KBS88290	LB88290 length outside diameter flange diameter flange depth	KB88290 length comp. height	KR88290 top 1.2 2nd 1.2 oil 2.0	
			pin = circlip required 13010-RNV-M00	N- R- T- 13011-RNA-A01 13011-RNA-A02 13011-RNB-A01 13021-RNA-A01 13021-RNA-A02	
2012 NEW					
HONDA A20A Bore Dia. 82.7 mm 4 cyl. 1,955 cc ACCORD (88-) SOHC 12V	KBS88300	LB88300 length outside diameter flange diameter flange depth	KB88300 length 65.3 comp. height 29.8 -2.4	KR88300 top 1.5 2nd 1.5 oil 4.0	 
			pin = 20.0 x 62.0 circlip not required 13101-PH4-000 13102-PH4-000 13103-PH4-000	N-SWH30-366/386 R-16165/ 16482 16485 / 16731 T-32370 / 32388 13011-PH4-003 13011-PH4-004 13011-PH4-601 13011-PH4-602 13011-PH4-651 13011-PH4-751 13011-PH4-752 13021-PH4-003 13021-PH4-004 13021-PH4-601/602	

HONDA

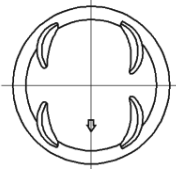
MOTOR - TYP	KOLBEN + RINGE PISTON + RINGS PISTONES + ANILLOS	LAUFBUCHSE CYL. SLEEVE CAMISAS	KOLBENSATZ PISTON SET PISTONES KIT	RINGSATZ RING SET ANILLOS	KOLBEN PISTON PISTONES
HONDA A20A Bore Dia. 82.7 mm 4 cyl. 1,955 cc ACCORD (87-) SOHC 12V	KBS88301	LB88301 length outside diameter flange diameter flange depth	KB88301 length 65.3 comp. 29.8 height -1.6 pin = 20.0 x 62.0 circlip not required	KR88301 top 1.5 2nd 1.5 oil 4.0 N-SWH30-366/386 R-16165/ 16482 16485 / 16731 T-32370 / 32388	
			13101-PH4-600 13102-PH4-600 13103-PH4-600	13011-PH4-003 13011-PH4-004 13011-PH4-601 13011-PH4-602 13011-PH4-651 13011-PH4-751 13011-PH4-752 13021-PH4-003 13021-PH4-004 13021-PH4-601/602	
HONDA A20A Bore Dia. 82.7 mm 4 cyl. 1,955 cc ACCORD (86-) SOHC 12V	KBS88302	LB88302 length outside diameter flange diameter flange depth	KB88302 length 65.3 comp. 29.8 height -2.3 pin = 20.0 x 62.0 circlip not required	KR88302 top 1.5 2nd 1.5 oil 4.0 N-SWH30-366/386 R-16165/ 16482 16485 / 16731 T-32370 / 32388	
			13101-PJO-000 13102-PJO-000 13103-PJO-000	13011-PH4-003 13011-PH4-004 13011-PH4-601 13011-PH4-602 13011-PH4-651 13011-PH4-751 13011-PH4-752 13021-PH4-003 13021-PH4-004 13021-PH4-601/602	
HONDA A20A BT1 Bore Dia. 82.7 mm 4 cyl. 1,955 cc ACCORD	KBS88310	LB88310 length outside diameter flange diameter flange depth	KB88310 length 65.3 comp. 30.0 height -1.2 pin = 20.0 x 62.0 circlip not required	KR88310 top 1.5 2nd 1.5 oil 4.0 N-SWH30-366/386 R-16165/ 16482 16485 / 16731 T-32370 / 32388	
			13101-PJO-308	13011-PH4-003 13011-PH4-004 13011-PH4-601 13011-PH4-602 13011-PH4-651 13011-PH4-751 13011-PH4-752 13021-PH4-003 13021-PH4-004 13021-PH4-601/602	

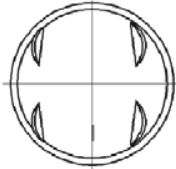

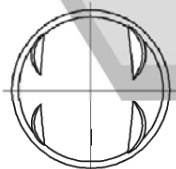
MOTOR - TYP	KOLBEN + RINGE PISTON + RINGS PISTONES + ANILLOS	LAUFBUCHSE CYL. SLEEVE CAMISAS	KOLBENSATZ PISTON SET PISTONES KIT	RINGSATZ RING SET ANILLOS	KOLBEN PISTON PISTONES
HONDA A20A Bore Dia. 82.7 mm 4 cyl. 1,955 cc ACCORD 	KBS88320	LB88320 length outside diameter flange diameter flange depth	KB88320 length 65.3 comp. height 29.8 -1.2 pin = 20.0 x 62.0	KR88320 top 1.5 2nd 1.5 oil 4.0 N-SWH30-366/386 R-16165/ 16482 16485 / 16731 T-32370 / 32388	
			13101-PJO-660	13011-PH4-003 13011-PH4-004 13011-PH4-601 13011-PH4-602 13011-PH4-651 13011-PH4-751 13011-PH4-752 13021-PH4-003 13021-PH4-004 13021-PH4-601/602	
HONDA B21A1 Bore Dia. 83.0 mm 4 cyl. 2,056 cc PRELUDE (90-91) DOHC 16V	KBS88330	LB88330 length outside diameter flange diameter flange depth	KB88330 length 65.4 comp. height 30.9 -0.9 pin = 22.0 x 62.0 circlip not required	KR88330 top 1.2 2nd 1.2 oil 2.8 N-SWH30-448 R- T-32377	
			13101-PK3-A01	13011-PK3-A04	
HONDA B20B4 Bore Dia. 84.0 mm 4 cyl. 1,972 cc CR-V (97- 98) DOHC 16V	KBS88340	LB88340 length outside diameter flange diameter flange depth	KB88340 length 59.6 comp. height 29.6 -4.1 pin = 21.0 x 56.5 circlip not required	KR88340 top 1.2 2nd 1.2 oil 2.8 N-SWH30-437 R-16205 T-32387/32396	
			13010-P3F-A00 13020-P3F-000 13101-P3F-A00	13011-P3F-003 13011-PHK-003 13021-P3F-003	

HONDA

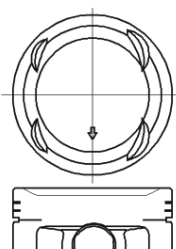
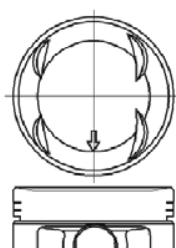
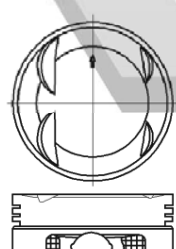
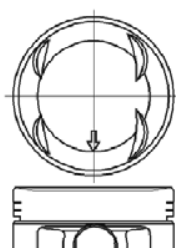
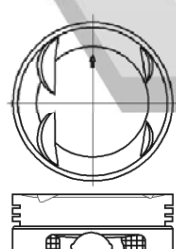
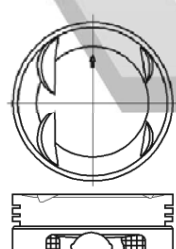
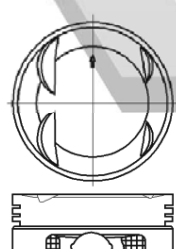
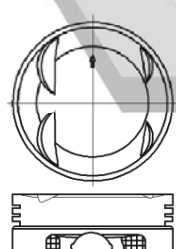
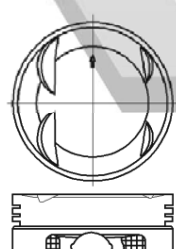
MOTOR - TYP	KOLBEN + RINGE PISTON + RINGS PISTONES + ANILLOS	LAUFBUCHSE CYL. SLEEVE CAMISAS	KOLBENSATZ PISTON SET PISTONES KIT	RINGSATZ RING SET ANILLOS	KOLBEN PISTON PISTONES
HONDA B20Z2 Bore Dia. 84.0 mm 4 cyl. 2,000 cc CR-V DOHC 16V	KBS88350	LB88350 length outside diameter flange diameter flange depth	length 59.6 comp. height 29.6 -0.65	top 1.2 2nd 1.2 oil 2.8	 
			pin = 21.0 x 56.4 circlip not required	N-SWH30-437 R-16205 T-32387/32396	
			13010-PHK-000 13101-PHK-000	13011-P3F-003 13011-PHK-003 13021-P3F-003	
HONDA F18A Bore Dia. 85.0 mm 4 cyl. 1,849 cc ACCORD	KBS88360	LB88360 length outside diameter flange diameter flange depth	length 65.2 comp. height 30.7 -2.7	top 1.2 2nd 1.2 oil 2.8	 
			pin = 22.0 x 57.0 circlip not required	N- R-16032/16036/16061 T-32383/32386	
			13101-PT1-000 13101-PT1-010	13011-POA-004 13011-PTO-004 13011-PT1-004 13011-PT1-G02 13011-PT2-003 13011-PT2-004	
HONDA Bore Dia. 85.0 mm 4 cyl. 1,997 cc ACCORD 16V	KBS88370	LB88370 length outside diameter flange diameter flange depth	length 65.2 comp. height 30.7 -2.0	top 1.2 2nd 1.2 oil 2.8	 
			pin = 22.0 x 57.0 circlip not required	N-SWH30-383 R-16063/16202/16203 T-32374/32378	
			13101-PT5-000	13011-PT0-B01/2 13011-PT0-B03/4 13011-PT4-X01/2 13011-PT4-X03/4	

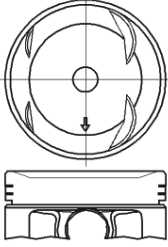

MOTOR - TYP	KOLBEN + RINGE PISTON + RINGS PISTONES + ANILLOS	LAUFBUCHSE CYL. SLEEVE CAMISAS	KOLBENSATZ PISTON SET PISTONES KIT	RINGSATZ RING SET ANILLOS	KOLBEN PISTON PISTONES	
HONDA F22A F22A1 Bore Dia. 85.0 mm 4 cyl. 2,156 cc ACCORD	KBS88380	LB88380 length outside diameter flange diameter flange depth	KB88380 length 65.2 comp. height 30.7 -3.9 pin = 22.0 x 57.0 circlip not required 13101-PT3-A01	KR88380 top 1.2 2nd 1.2 oil 2.8 N- R-16032/16036/16061 T-32383/32386 13011-POA-004 13011-PT0-004 13011-PT1-004 13011-PT1-G02 13011-PT2-003 13011-PT2-004		
			length 65.1 comp. height 30.5 -1.9 pin = 22.0 x 57.0 N-SWH30-383 R-16063/16202/16203 T-32374/32378 13011-PT0-B01/2 13011-PT0-B03/4 13011-PT4-X01/2 13011-PT4-X03/4			
			length 52.0 comp. height 30.5 -1.6 pin = 22.0 x 56.5 circlip required N-SWH30-383 R-16063/16202/16203 T-32374/32378 13011-PT0-B01/2 13011-PT0-B03/4 13011-PT4-X01/2 13011-PT4-X03/4			
HONDA F22A F22A1 Bore Dia. 85.0 mm 4 cyl. 1,997 cc ACCORD	KBS88390	LB88390 length outside diameter flange diameter flange depth	KB88390 length 65.1 comp. height 30.5 -1.9 pin = 22.0 x 57.0 N-SWH30-383 R-16063/16202/16203 T-32374/32378 13011-PT0-B01/2 13011-PT0-B03/4 13011-PT4-X01/2 13011-PT4-X03/4			
length 65.1 comp. height 30.5 -1.9 pin = 22.0 x 57.0 N-SWH30-383 R-16063/16202/16203 T-32374/32378 13011-PT0-B01/2 13011-PT0-B03/4 13011-PT4-X01/2 13011-PT4-X03/4						
length 52.0 comp. height 30.5 -1.6 pin = 22.0 x 56.5 circlip required N-SWH30-383 R-16063/16202/16203 T-32374/32378 13011-PT0-B01/2 13011-PT0-B03/4 13011-PT4-X01/2 13011-PT4-X03/4						
HONDA F22A F22A1 Bore Dia. 85.0 mm 4 cyl. 1,997 cc ACCORD	KBS88400	LB88400 length outside diameter flange diameter flange depth			KB88400 length 52.0 comp. height 30.5 -1.6 pin = 22.0 x 56.5 circlip required N-SWH30-383 R-16063/16202/16203 T-32374/32378 13011-PT0-B01/2 13011-PT0-B03/4 13011-PT4-X01/2 13011-PT4-X03/4	
length 52.0 comp. height 30.5 -1.6 pin = 22.0 x 56.5 circlip required N-SWH30-383 R-16063/16202/16203 T-32374/32378 13011-PT0-B01/2 13011-PT0-B03/4 13011-PT4-X01/2 13011-PT4-X03/4						
length 52.0 comp. height 30.5 -1.6 pin = 22.0 x 56.5 circlip required N-SWH30-383 R-16063/16202/16203 T-32374/32378 13011-PT0-B01/2 13011-PT0-B03/4 13011-PT4-X01/2 13011-PT4-X03/4						

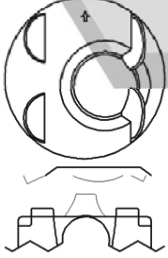
HONDA

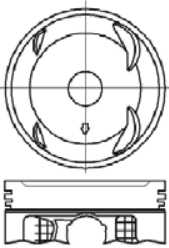
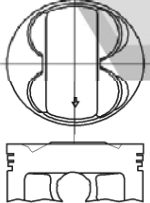
MOTOR - TYP	KOLBEN + RINGE PISTON + RINGS PISTONES + ANILLOS	LAUFBUCHSE CYL. SLEEVE CAMISAS	KOLBENSATZ PISTON SET PISTONES KIT	RINGSATZ RING SET ANILLOS	KOLBEN PISTON PISTONES
HONDA F22B1 Bore Dia. 85.0 mm 4 cyl. cc ACCORD	KBS88410	LB88410 length outside diameter flange diameter flange depth	KB88410 length 65.0 comp. height 30.5 -3.2 pin = 22.0 x 57.0 circlip not required	KR88410 top 1.2 2nd 1.2 oil 2.8 N- R-16032/16036/16061 T-32383/32386	
			13010-P1E-000 13020-P1E-000 13030-POA-010 13040-POA-010	13011-POA-004 13011-PTO-004 13011-PT1-004 13011-PT1-G02 13011-PT2-003 13011-PT2-004	
2012 NEW					
HONDA CB-400 Bore Dia. 85.0 mm 4 cyl. 547 cc	KBS88420	LB88420 length outside diameter flange diameter flange depth	KB88420 length 53.1 comp. height 26.1 -0.85 pin = 20.0 x 57.5 circlip required	KR88420 top 1.2 2nd 1.2 oil 2.0 N-SWH30-383 R-16063/16202/16203 T-32374/32378	
			13011-PT0-B01/2 13011-PT0-B03/4 13011-PT4-X01/2 13011-PT4-X03/4		
2012 NEW					
HONDA K20A3 Bore Dia. 86.0 mm 4 cyl. 1,998 cc CIVIC CR-V FR-V STREAM (02-05) DOHC 16V	KBS88430 skirt MOS2 treated	LB88430 length outside diameter flange diameter flange depth	KB88430 length 51.4 comp. height 29.4 +2.4 -3.6 pin = 21.96 x 52.2 circlip required	KR88430 top 1.2 2nd 1.2 oil 2.0 N-SWH30-454 R-16400 T-32399	
			13010-PNC-000 13020-PNC-000 13030-PNC-000	13011-PNE-G02 13011-PNF-G01 13011-PRA-E02 13021-PNF-G01 13021-PRA-E02	

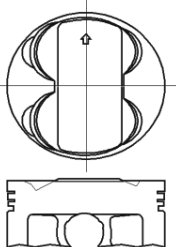
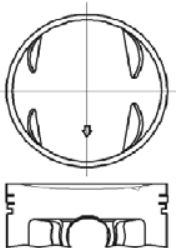
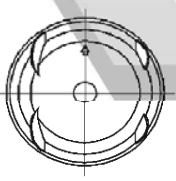
MOTOR - TYP	KOLBEN + RINGE PISTON + RINGS PISTONES + ANILLOS	LAUFBUCHSE CYL. SLEEVE CAMISAS	KOLBENSATZ PISTON SET PISTONES KIT	RINGSATZ RING SET ANILLOS	KOLBEN PISTON PISTONES
HONDA K20Z3 Bore Dia. 86.0 mm 4 cyl. 1,998 cc CIVIC (07-) DOHC 16V	KBS88440 skirt MOS2 treated	LB88440 length outside diameter flange diameter flange depth	KB88440 length 52.0 comp. height 30.0 +3.8 -5.3 pin = 21.96 x 52.2 circlip required 13010-PRB-A01 13020-PRB-A01 13030-PRB-A01	KR88440 top 1.2 2nd 1.2 oil 2.0 N-SWH30-454 R-16400 T-32399 13011-PNE-G02 13011-PNF-G01 13011-PRA-E02 13021-PNF-G01 13021-PRA-E02	
			13010-PAA-A00 13010-PEA-A00 13020-PAA-A00 13030-PAA-A00 13030-PAB-A00	13011-P8A-A01 13011-PAA-Y01 13011-PEA-003 13011-PEA-004 13011-PN8-P01 13011-PNB-G01 13011-PVB-003 13011-PVB-013 13021-P8A-A01 13021-PEA-003 13021-PEA-004	
HONDA F23A1 Bore Dia. 86.0 mm 4 cyl. 2,254 cc ACCORD (98-02) SOHC 16V	KBS88450	LB88450 length outside diameter flange diameter flange depth	KB88450 length 51.4 comp. height 30.0 -3.0 -5.1 pin = 22.0 x 54.0 circlip required 13010-PAA-A00 13010-PEA-A00 13020-PAA-A00 13030-PAA-A00 13030-PAB-A00	KR88450 top 1.2 2nd 1.2 oil 2.8 N-SWH30-443 R-16054/16056 16060 T-32395/32390 13011-P8A-A01 13011-PAA-Y01 13011-PEA-003 13011-PEA-004 13011-PN8-P01 13011-PNB-G01 13011-PVB-003 13011-PVB-013 13021-P8A-A01 13021-PEA-003 13021-PEA-004	
			13010-P13-A00 13020-P13-A00 13030-P13-A00 13101-P13-A00	13011-P13-003 13011-P13-004 13011-P5M-003 13011-P5M-013 13021-P13-003 13021-P13-004	
HONDA H22A H22A1 Bore Dia. 87.0 mm 4 cyl. 2,156 cc PRELUDE (94-) DOHC 16V	KBS88460	LB88460 length outside diameter flange diameter flange depth	KB88460 length 62.0 comp. height 31.0 +1.0 pin = 22.0 x 57.0 circlip not required 13010-P13-A00 13020-P13-A00 13030-P13-A00 13101-P13-A00	KR88460 top 1.2 2nd 1.2 oil 2.8 N-SWH30-433 R-16271 T-32389 13011-P13-003 13011-P13-004 13011-P5M-003 13011-P5M-013 13021-P13-003 13021-P13-004	

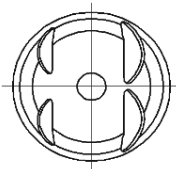
MOTOR - TYP	KOLBEN + RINGE PISTON + RINGS PISTONES + ANILLOS	LAUFBUCHSE CYL. SLEEVE CAMISAS	KOLBENSATZ PISTON SET PISTONES KIT	RINGSATZ RING SET ANILLOS	KOLBEN PISTON PISTONES
HONDA H22A H22A4 Bore Dia. 87.0 mm 4 cyl. 2,156 cc PRELUDE (01) DOHC 16V	KBS88470	LB88470	KB88470 length 61.8 comp. height 31.0 +0.8 pin = 22.0 x 57.0 circlip required 13010-P5M-A00 13020-P5M-A00 13030-P5M-A00 13101-P5M-A00	KR88470 top 1.2 2nd 1.2 oil 2.8 N-SWH30-433 R-16271 T-32389 13011-P13-003 13011-P13-004 13011-P5M-003 13011-P5M-013 13021-P13-003 13021-P13-004	
HONDA H23A H23A1 Bore Dia. 87.0 mm 4 cyl. 2,259 cc PRELUDE (92-95)	KBS88480	LB88480	KB88480 length 60.5 comp. height 30.6 -3.2 pin = 22.0 x 57.0 circlip not required 13010-P14-A00 13020-P14-A00 13030-P14-A00 13101-P14-A00	KR88480 top 1.2 2nd 1.2 oil 2.8 N-SWH30-433 R-16271 T-32389 13011-P13-003 13011-P13-004 13011-P5M-003 13011-P5M-013 13021-P13-003 13021-P13-004	
HONDA K24A1 Bore Dia. 87.0 mm 4 cyl. 2,354 cc CR-V (05) DOHC 16V	KBS89000	LB89000	KB89000 length 53.5 comp. height 29.5 -2.5 -3.6 pin = 22.0 x 52.2 circlip required 13010-PPA-000 13010-PPA-010 13020-PPA-000 13020-PPA-010 13030-PPA-000 13030-PPA-010	KR89000 top 1.2 2nd 1.2 oil 2.0 N-SWH30-466 R-16053 T- 13011-PPA-003 13011-PPA-004 13011-RAA-A01 13011-RAD-004 13021-PPA-003 13021-RAD-004	

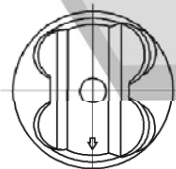
MOTOR - TYP	KOLBEN + RINGE PISTON + RINGS PISTONES + ANILLOS	LAUFBUCHSE CYL. SLEEVE CAMISAS	KOLBENSATZ PISTON SET PISTONES KIT	RINGSATZ RING SET ANILLOS	KOLBEN PISTON PISTONES
HONDA K24A2 Bore Dia. 87.0 mm 4 cyl. 2,354 cc ACCORD ACCORD TOURER (03-05) DOHC 16V	KBS89001 skirt MOS2 treated	LB89001 length outside diameter flange diameter flange depth	KB89001 length 52.0 comp. height 30.0 -1.0 -5.3	KR89001 top 1.2 2nd 1.2 oil 2.5	
			pin = 21.96 x 52.2 circlip required 13010-RBB-000 13020-RBB-000 13030-RBB-000	N- R- T- 13011-RBB-004 13011-RBB-006 13021-RBB-004 13021-RBB-006	
HONDA K24A4 Bore Dia. 87.0 mm 4 cyl. 2,354 cc ACCORD ELEMENT (03-06) DOHC 16V	KBS89002 skirt MOS2 treated	LB89002 length outside diameter flange diameter flange depth	KB89002 length 51.4 comp. height 29.5 +3.4 -3.7	KR89002 top 1.2 2nd 1.2 oil 2.0	
			pin = 21.96 x 52.2 circlip required 13010-RAA-A01 13020-RAA-A01 13030-RAA-A00 13030-RAA-A01	N-SWH30-466 R-16053 T- 13011-PPA-003 13011-PPA-004 13011-RAA-A01 13011-RAD-004 13021-PPA-003 13021-RAD-004	
HONDA H22A Bore Dia. 87.0 mm 4 cyl. cc	KBS88520 head anodized skirt MOS2 treated	LB88520 length outside diameter flange diameter flange depth	KB88520 length 64.5 comp. height 31.0 +3.5 -5.9	KR88520 top 1.2 2nd 1.2 oil 2.8	
			pin = 22.0 x 57.0 circlip required 13010-P5P-J00	N-SWH30-433 R-16271 T-32389 13011-P13-003 13011-P13-004 13011-P5M-003 13011-P5M-013 13021-P13-003 13021-P13-004	

HONDA

2012 NEW

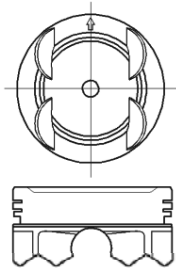
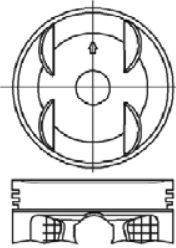
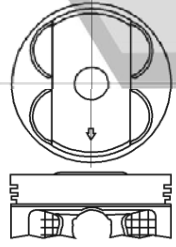
MOTOR - TYP	KOLBEN + RINGE PISTON + RINGS PISTONES + ANILLOS	LAUFBUCHSE CYL. SLEEVE CAMISAS	KOLBENSATZ PISTON SET PISTONES KIT	RINGSATZ RING SET ANILLOS	KOLBEN PISTON PISTONES
HONDA C25A1 Bore Dia. 84.0 mm 6 cyl. 2,493 cc LEGEND DOHC 24V	KBS88530 skirt MOS2 treated	LB88530 length outside diameter flange diameter flange depth	KB88530 length 63.0 comp. height 31.5 -1.3 pin = 22.0 x 57.0 circlip not required	KR88530 top 1.2 2nd 1.2 oil 4.0 N-SWH30-369 R-16531 T-32372	
			13101-PH7-000	13011-PH7-003 13011-PH7-004	
HONDA J30A Bore Dia. 86.0 mm 6 cyl. 2,997 cc ACCORO (98-02) DOHC 24V	KBS88540	LB88540 length outside diameter flange diameter flange depth	KB88540 length 51.4 comp. height 30.0 -0.7 -3.6 pin = 22.0 x 54.0 circlip required	KR88540 top 1.2 2nd 1.2 oil 2.8 N-SWH30-432 R- T-	
			13010-P8A-A00 13030-P8A-A00 13040-P8A-A00	13011-P8A-A01 13011-RCA-A01 13011-RDV-J01 13021-P8A-A01 13021-RCA-A01 13021-RDV-J01 13031-P8A-A01 13031-RCA-A01 13031-RDV-J01	
HONDA J30A4 Bore Dia. 86.0 mm 6 cyl. 2,997 cc ACCORD (03-06) DOHC 24V	KBS88550 skirt MOS2 treated	LB88550 length outside diameter flange diameter flange depth	KB88550 length 51.5 comp. height 30.0 +0.75 -3.9 pin = 22.0 x 54.2 circlip required	KR88550 top 1.2 2nd 1.2 oil 2.8 N-SWH30-432 R- T-	
			13010-RCA-A00 13030-RCA-A00 13040-RCA-A00	13011-P8A-A01 13011-RCA-A01 13011-RDV-J01 13021-P8A-A01 13021-RCA-A01 13021-RDV-J01 13031-P8A-A01 13031-RCA-A01 13031-RDV-J01	

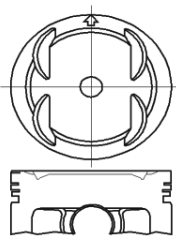
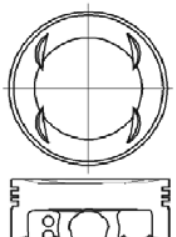
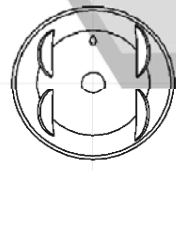
MOTOR - TYP	KOLBEN + RINGE PISTON + RINGS PISTONES + ANILLOS	LAUFBUCHSE CYL. SLEEVE CAMISAS	KOLBENSATZ PISTON SET PISTONES KIT	RINGSATZ RING SET ANILLOS	KOLBEN PISTON PISTONES
HONDA C27A Bore Dia. 87.0 mm 6 cyl. 2,675 cc LEGEND (88-90) DOHC 24V	KBS88560	LB88560 length outside diameter flange diameter flange depth	KB88560 length 63.1 comp. height 31.6 -1.5 pin = 22.0 x 57.0 circlip not required	KR88560 top 1.2 2nd 1.2 oil 4.0 N-SWH30-370 R-16011 T-32373	
			13101-PL2-000 13102-PL2-000 13103-PL2-000 13104-PL2-000	13011-PL2-003 13011-PL2-004 13011-POG-A01 13021-PL2-003 13021-PL2-004 13031-PL2-003 13031-PL2-004	
HONDA J35A1 Bore Dia. 89.0 mm 6 cyl. 3,471 cc ODYSSEY (00-04) DOHC 24V	KBS88570	skirt MOS2 treated length outside diameter flange diameter flange depth	KB88570 length 51.5 comp. height 30.0 -2.3 -3.1 pin = 21.97 x 54.0 circlip required	KR88570 top 1.2 2nd 1.2 oil 2.8 N-SWH30-438 R- T-	
			13010-P8F-A01 13030-P8F-A00 13030-P8F-A01 13040-P8F-A00 13040-P8F-A01 13101-P8F-A01	13011-P8F-A01 13011-P8F-Y01 13011-PGE-A01 13021-P8F-Y01 13021-PGE-A01 13031-P8F-A11 13031-P8F-Y01	
HONDA J35A3 Bore Dia. 89.0 mm 6 cyl. 3,471 cc MR-V ODYSSEY (02-04) DOHC 12V	KBS88580	skirt MOS2 treated length outside diameter flange diameter flange depth	KB88580 length 51.5 comp. height 30.0 -1.24 -3.7 pin = 22.0 x 54.0 circlip required	KR88580 top 1.2 2nd 1.2 oil 2.8 N-SWH30-438 R- T-	
			13010-PGK-A00 13010-PGK-A01 13030-PGK-A00 13040-P8F-A02	13011-P8F-A01 13011-P8F-Y01 13021-P8F-Y01 13031-P8F-Y01 13011-PGE-A01 13021-PGE-A01 13031-P8F-A11	

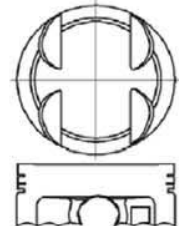
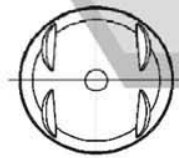
MOTOR - TYP	KOLBEN + RINGE PISTON + RINGS PISTONES + ANILLOS	LAUFBUCHSE CYL. SLEEVE CAMISAS	KOLBENSATZ PISTON SET PISTONES KIT	RINGSATZ RING SET ANILLOS	KOLBEN PISTON PISTONES			
HONDA J32A Bore Dia. 89.0 mm 6 cyl. cc	KBS88585	LB88585	KB88585	KR88585				
						length	length 51.5	top 1.2
						outside diameter	comp. height 30.0 -3.7	2nd 1.2 oil 2.8
						flange diameter	pin = 22.0 x 54.2 circlip required	N-SWH30-438 R- T-
flange depth	13010-P8E-L00	13011-P8F-A01 13011-P8F-Y01 13011-PGE-A01 13021-P8F-Y01 13021-PGE-A01 13031-P8F-A11 13031-P8F-Y01						
2012 NEW								
HONDA C32A1 Bore Dia. 90.0 mm 6 cyl. 3,206 cc LEGEND (95) DOHC 24V	KBS88590	LB88590	KB88590	KR88590				
						length	length 61.8	top 1.2
						outside diameter	comp. height 30.9 -0.35	2nd 1.2 oil 2.8
						flange diameter	pin = 22.0 x 57.0 circlip not required	N-SWH30-371 R-16037/ 16038 T-32385
flange depth	13101-PY3-000 13101-PY3-A00 13101-PY3-A02 13102-PY3-A02 13103-PY3-A01 13104-PY3-A01	13011-P5G-003 13011-PY3-003 13011-PY3-004 13011-PY3-Y01 13011-PY3-Y02 13021-PY3-003 13031-P5G-003 13031-PY3-003						
HONDA C35A1 Bore Dia. 90.0 mm 6 cyl. 3,474 cc ACURA 3.5RL LEGEND (96-04) DOHC 24V	KBS88600	LB88600	KB88600	KR88600				
						length	length 59.0	top 1.5
						outside diameter	comp. height 31.0 -3.3 -3.5	2nd 1.2 oil 2.8
						flange diameter	pin = 22.0 x 57.0 circlip required	N- R- T-
flange depth	13010-P5A-000 13020-P5A-000 13030-P5A-000 13040-P5A-000	13011-P5A-003 13011-P5A-004 13021-P5A-003 13021-P5A-004 13031-P5A-003 13031-P5A-004						

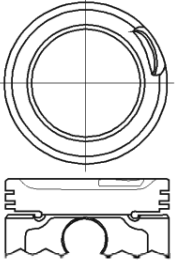
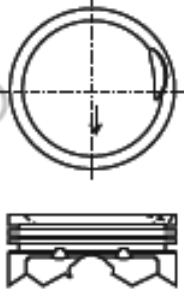
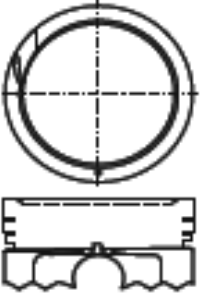
MOTOR - TYP	KOLBEN + RINGE PISTON + RINGS PISTONES + ANILLOS	LAUFBUCHSE CYL. SLEEVE CAMISAS	KOLBENSATZ PISTON SET PISTONES KIT	RINGSATZ RING SET ANILLOS	KOLBEN PISTON PISTONES
HYUNDAI G4HC Bore Dia. 66.0 mm 4 cyl. 999 cc ATOS SOHC 12V	KBS72500	LB72500 length 200.0 outside diameter 70.0 flange diameter flange depth	KB72500 length 50.0 comp. height 25.0 -4.1 -5.5 pin = 17.0 x 46.0 circlip not required	KR72500 top 1.2 2nd 1.2 oil 2.5 N-SWG30-018 R-40527 T-42002	
			23410-02310 23410-02610 23410-02700 23410-02710 23410-02720 23410-02981 23410-02982 23410-02911 23410-02912 23410-02931/2	23040-02700 23040-02710 23040-02931 23040-02932 23040-02935 23040-02936	
HYUNDAI PICANTO Bore Dia. 67.0 mm 4 cyl. cc ATOS 1.1 SANTRO SOHC	KBS72510	LB72510 length outside diameter flange diameter flange depth	KB72510 length 48.5 comp. height 24.5 -4.5 pin = 17.0 x 46.5 circlip not required	KR72510 top 1.2 2nd 1.2 oil 2.0 N- R- T-	
			23410-02270 23410-02470 23410-02965 23410-02966	23040-02820 23040-02950 23040-02955 23040-02970 23040-02981 23040-02982	
HYUNDAI 1.3 Bore Dia. 71.5 mm 4 cyl. 1,341 cc VERNA SOHC 12V	KBS72520	LB72520 length outside diameter flange diameter flange depth	KB72520 length 53.8 comp. height 30.8 -0.7 pin = 18.0 x 47.5 circlip not required	KR72520 top 1.5 2nd 1.5 oil 3.0 N-SWG30-016 R-40770 T-42003	
			23410-22712 23410-22971 23410-22972	23040-22300 23040-22301 23040-22350 23040-22351 23040-22931 23040-22932 23040-22935/6 23040-22393 23040-22340 23040-22961/2	

HYUNDAI

2012 NEW

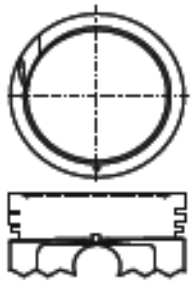
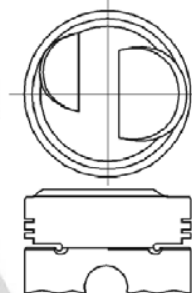
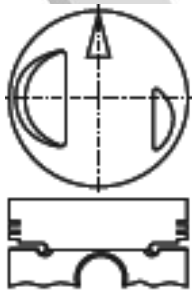

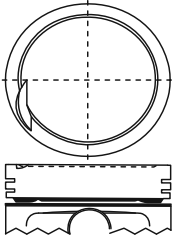
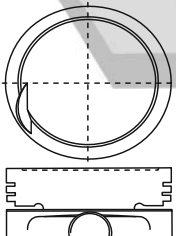
MOTOR - TYP	KOLBEN + RINGE PISTON + RINGS PISTONES + ANILLOS	LAUFBUCHSE CYL. SLEEVE CAMISAS	KOLBENSATZ PISTON SET PISTONES KIT	RINGSATZ RING SET ANILLOS	KOLBEN PISTON PISTONES
HYUNDAI G4EH Bore Dia. 71.5 mm 4 cyl. 1,341 cc ACCENT SOHC 12V	KBS72530	LB72530 length outside diameter flange diameter flange depth	length 54.3 comp. height 31.3 -1.1	top 1.5 2nd 1.5 oil 3.0	
			pin = 18.0 x 47.5 circlip not required 23410-22250 23410-22260 23410-22270 23410-22350 23410-22360 23410-22370 23410-22935 23410-22936 23410-22937 23410-22938	N-SWG30-016 R-40770 T-42003 23040-22300 23040-22301 23040-22350 23040-22351 23040-22931 23040-22932 23040-22935/6 23040-22939 23040-22940 23040-22961/2	
HYUNDAI 4G36 Bore Dia. 73.0 mm 4 cyl. 1,238 cc PONY SOHC 8V	KBS72540	LB72540 length 150.0 outside diameter 77.0 flange diameter flange depth	length 82.5 comp. height 39.5 +3.5	top 1.5 2nd 1.5 oil 4.0	
			pin = 19.0 x 64.0 circlip not required 23410-11205 23410-11206 23410-11207 23410-11208 23410-11210 23410-11214 23410-11220	N- R- T- 20930-11000 20930-11010 20930-11020 20930-11030 20930-11040/50 20930-11260/70 20930-11280/90 20930-11400 20930-11410/20 20930-11430/40	
HYUNDAI 4G33 Bore Dia. 73.0 mm 4 cyl. 1,439 cc PONY SOHC 8V	KBS72550	LB72550 length 150.0 outside diameter 77.0 flange diameter flange depth	length 70.2 comp. height 33.2 +0	top 1.5 2nd 1.5 oil 4.0	
			pin = 19.0 x 64.0 circlip not required 23410-11405 23410-11406 23410-11407 23410-11408 23410-11421 23410-11424	N- R- T- 20930-11000 20930-11010 20930-11020 20930-11030 20930-11040/50 20930-11260/70 20930-11280/90 20930-11400 20930-11410/20 20930-11430/40	

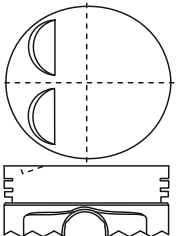
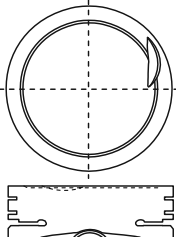
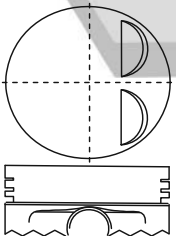
MOTOR - TYP	KOLBEN + RINGE PISTON + RINGS PISTONES + ANILLOS	LAUFBUCHSE CYL. SLEEVE CAMISAS	KOLBENSATZ PISTON SET PISTONES KIT	RINGSATZ RING SET ANILLOS	KOLBEN PISTON PISTONES
HYUNDAI X1 Bore Dia. 75.5 mm 4 cyl. 1,495 cc VERNA DOHC 16V	KBS72560	LB72560	KB72560	KR72560	
		length 140.0 outside diameter 79.5 flange diameter flange depth	length 58.0 comp. height 29.0 -0.7 pin = 18.0 x 60.0 circlip not required 23410-21114 23410-21915 23410-21916 23410-21917 23410-21918	top 1.5 2nd 1.5 oil 4.0 N-SWG30-023 R-40163 T-42019 23040-21110 23040-24100 23040-24200 23040-24221/2 23040-24223/4 23040-24232 23040-24931/2 23040-24933/4 23431-21110	
HYUNDAI G4EK Bore Dia. 75.5 mm 4 cyl. 1,495 cc ACCENT	KBS72570	LB72570	KB72570	KR72570	
		length 140.0 outside diameter 79.5 flange diameter flange depth	length 54.4 comp. height 31.3 -0.7 -2.2 pin = 18.0 x 47.5 circlip not required 23410-22400 23410-22410 23410-22420 23410-22450 23410-22460 23410-22470	top 1.5 2nd 1.5 oil 3.0 N-SWG30-017 R-40765 T-42004 23040-22010 23040-22050 23040-22911 23040-22912 23040-22913 23040-22914 23040-22951/2 23040-22953/4 23040-22601 23040-22901/2	
HYUNDAI G4EK Bore Dia. 75.5 mm 4 cyl. 1,495 cc	KBS72571	LB72571	KB72571	KR72571	
		length 140.0 outside diameter 79.5 flange diameter flange depth	length 54.4 comp. height 31.3 -0.7 pin = 18.0 x 47.5 circlip not required	top 1.5 2nd 1.5 oil 4.0 N-SWG30-023 R-40163 T-42019 23040-21110 23040-24100 23040-24200 23040-24221/2 23040-24223/4 23040-24232 23040-24931/2 23040-24933/4 23431-21110	

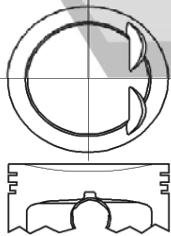

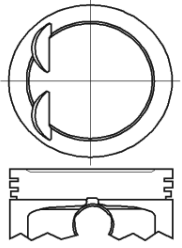
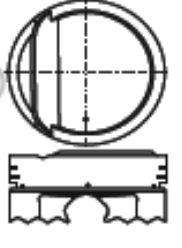
MOTOR - TYP	KOLBEN + RINGE PISTON + RINGS PISTONES + ANILLOS	LAUFBUCHSE CYL. SLEEVE CAMISAS	KOLBENSATZ PISTON SET PISTONES KIT	RINGSATZ RING SET ANILLOS	KOLBEN PISTON PISTONES
HYUNDAI G4EK G4FK Bore Dia. 75.5 mm 4 cyl. 1,495 cc	KBS72580	LB72580 length 140.0 outside diameter 79.5 flange diameter flange depth	KB72580 length 53.4 comp. height 30.4 -4.2 pin = 18.0 x 47.3 circlip not required 23410-26012 23410-26013 23410-26913 23410-26914 23410-26915 23410-26916 23410-26917 23410-26918 23410-26919 23410-26920	KR72580 top 1.2 2nd 1.5 oil 3.0 N-SWG30-019 SW L03-052 R-20630 T-42025 23010-26001 23040-26000 23040-26001 23040-26902 23040-26903 23040-26904 23040-26905	
HYUNDAI G4EK Bore Dia. 75.5 mm 4 cyl. 1,495 cc	KBS72590	LB72590 length 140.0 outside diameter 79.5 flange diameter flange depth	KB72590 length 53.7 comp. height 30.7 -0.2 -1.7 pin = 18.0 x 47.5 circlip not required 23410-22612 23410-22961 23410-22962 23410-22963 23410-22964	KR72590 top 1.5 2nd 1.5 oil 3.0 N-SWG30-017 R-40765 T-42004 23040-22010 23040-22050 23040-22911 23040-22912 23040-22913 23040-22914 23040-22951/2 23040-22953/4 23040-22601 23040-22901/2	
HYUNDAI 1.5 Bore Dia. 75.5 mm 4 cyl. 1,495 cc	KBS72600	LB72600 length 140.0 outside diameter 79.5 flange diameter flange depth	KB72600 length 53.5 comp. height 30.5 +1.1 pin = 18.0 x 47.5 circlip not required 23410-26611 23410-26612 23410-26613 23410-26614 23410-26615	KR72600 top 1.2 2nd 1.5 oil 3.0 N-SWG30-019 SW L03-052 R-20630 T- 23010-26001 23040-26000 23040-26001 23040-26902 23040-26903 23040-26904 23040-26905	

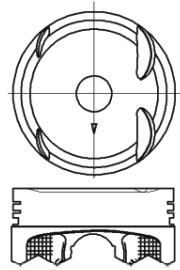

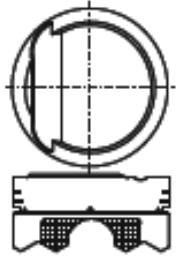
MOTOR - TYP	KOLBEN + RINGE PISTON + RINGS PISTONES + ANILLOS	LAUFBUCHSE CYL. SLEEVE CAMISAS	KOLBENSATZ PISTON SET PISTONES KIT	RINGSATZ RING SET ANILLOS	KOLBEN PISTON PISTONES
HYUNDAI G4AJ G4DJ Bore Dia. 75.5 mm 4 cyl. 1,468 1,495 cc SOHC 8V	KBS72610	LB72610 length 140.0 outside diameter 79.5 flange diameter flange depth	KB72610 length 58.5 comp. height 29.5 -3.6 pin = 18.0 x 60.0 circlip not required 23410-24100 23410-24110 23410-24120 23410-24911 23410-24912 23410-24913 23410-24914	KR72610 top 1.5 2nd 1.5 oil 4.0 N-SWG30-023 R-40163 T-42019 23040-21110 23040-24100 23040-24200 23040-24221/2 23040-24223/4 23040-24232 23040-24931/2 23040-24933/4 23431-21110	
HYUNDAI G4EK-T Bore Dia. 75.5 mm 4 cyl. 1,495 cc S-COUPLE SOHC 12V	KBS72620	LB72620 length 140.0 outside diameter 79.5 flange diameter flange depth	KB72620 length 54.4 comp. height 31.3 -2.1 -6.6 pin = 18.0 x 47.5 circlip not required 23410-22010 23410-22110 23410-22160 23410-22901 23410-22902 23410-22903 23410-22904 23410-22905-8 23410-22911-8	KR72620 top 1.5 2nd 1.5 oil 3.0 N-SWG30-017 R-40765 T-42004 23040-22010 23040-22050 23040-22911 23040-22912 23040-22913 23040-22914 23040-22951/2 23040-22953/4 23040-22601 23040-22901/2	
HYUNDAI G4ED Bore Dia. 76.5 mm 4 cyl. 1,599 cc ACCENT DOHC 16V	KBS72630 skirt MOS2 treated	LB72630 length outside diameter flange diameter flange depth	KB72630 length 50.2 comp. height 28.2 -0.5 -3.5 pin = 18.0 x 47.0 circlip not required 23410-26500 23410-26510 23410-26520	KR72630 top 1.2 2nd 1.2 oil 2.0 N- R- T- 23040-26160 23040-26170	

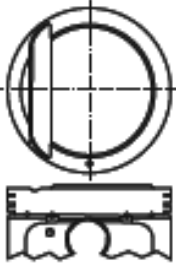
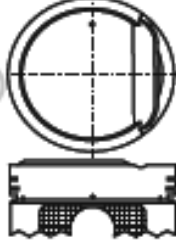
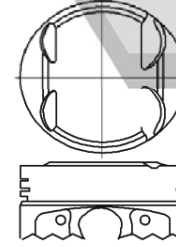
MOTOR - TYP	KOLBEN + RINGE PISTON + RINGS PISTONES + ANILLOS	LAUFBUCHSE CYL. SLEEVE CAMISAS	KOLBENSATZ PISTON SET PISTONES KIT	RINGSATZ RING SET ANILLOS	KOLBEN PISTON PISTONES	
HYUNDAI G4ED Bore Dia. 76.5 mm 4 cyl. 1,599 cc ACCENT COUPLE ELANTRA GETZ LAVITA MATRIX (99-03) DOHC 16V	KBS72631	LB72631	length 50.4	top 1.2		
			outside diameter	comp. height 28.4 -0.75 -3.0		2nd 1.2 oil 2.5
			flange diameter	pin = 18.0 x 47.3 circlip not required		N-SWG30-030 R-40070 T-
			flange depth	23410-26101 23410-26111 23410-26121		23040-26101
HYUNDAI G4GR Bore Dia. 77.4 mm 4 cyl. 1,559 cc COUPLE DOHC 16V	KBS72640	LB72640	length 60.8	top 1.2		
			outside diameter	comp. height 31.1 +1.7		2nd 1.2 oil 2.5
			flange diameter	pin = 20.0 x 59.0 circlip not required		N-SWG30-025 R-40837 T-42006/ 42008
			flange depth	23410-23100 23410-23105 23410-23110/15 23410-23120/25 23410-23155 23410-23165/75 23410-23911/12 23410-23913/14 23410-23915/16 23410-23917/18		23040-23100 23040-23150 23040-23911 23040-23912 23040-23913
HYUNDAI Y2 Bore Dia. 80.6 mm 4 cyl. 1,795 cc SONATA (89-98) SOHC 8V	KBS72650	LB72650	length 150.0	top 1.5		
			outside diameter 84.5	length 72.0		2nd 1.5
			flange diameter	comp. height 35.0 +0.4 +3.0		oil 4.0
			flange depth	pin = 21.0 x 72.0 circlip not required		N- R- T-
			23410-32410 23410-32491 23410-32492 23410-32493 23410-32494	23040-32410 23040-32945 23040-32946 23040-32947 23040-32948		

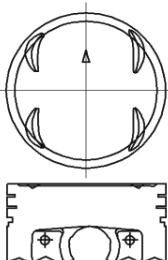
MOTOR - TYP	KOLBEN + RINGE PISTON + RINGS PISTONES + ANILLOS	LAUFBUCHSE CYL. SLEEVE CAMISAS	KOLBENSATZ PISTON SET PISTONES KIT	RINGSATZ RING SET ANILLOS	KOLBEN PISTON PISTONES
HYUNDAI G4CN G4DM Bore Dia. 81.5 mm 4 cyl. 1,836 cc DOHC 16V	KBS72660	LB72660 length outside diameter flange diameter flange depth	KB72660 length 66.9 comp. height 35.0 -0.9 -4.3 pin = 21.0 x 66.0 circlip not required	KR72660 top 1.2 2nd 1.5 oil 3.0 N-SWG30-032 R- T-	
			23410-33400 23410-33410 23410-33420 23410-33440	23040-33420 23040-33430 23040-33955 23040-33956 23040-33957 23040-33958 23040-33971 23040-33972 23040-33973/4 23040-38000	
HYUNDAI G4CN Bore Dia. 82.0 mm 4 cyl. 1,795 cc	KBS72670	LB72670 length outside diameter flange diameter flange depth	KB72670 length 63.2 comp. height 31.1 +2.1 pin = 20.0 x 59.0 circlip not required	KR72670 top 2.0 2nd 2.0 oil 4.0 N- R- T-	
HYUNDAI G4GM Bore Dia. 82.0 mm 4 cyl. 1,795 cc COUPLE DOHC 16V	KBS72680	LB72680 length outside diameter flange diameter flange depth	KB72680 length 60.9 comp. height 31.0 +2.2 -4.0 pin = 20.0 x 59.0 circlip not required	KR45000 top 1.2 2nd 1.2 oil 2.5 N-SWG30-028 SW L03-151 R-40832 T-42010	
			23410-23000 23410-23010 23410-23020 23410-23050 23410-23060 23410-23070 23410-23901 23410-23902/3 23410-23931 23410-23932/3	23040-23000 23040-23050 23040-23200 23040-23921 23040-23922 23040-23951/2 23040-23953/4 23040-23911 23040-23912 23040-23913	

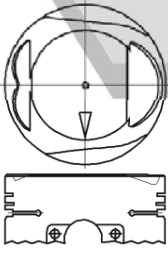
MOTOR - TYP	KOLBEN + RINGE PISTON + RINGS PISTONES + ANILLOS	LAUFBUCHSE CYL. SLEEVE CAMISAS	KOLBENSATZ PISTON SET PISTONES KIT	RINGSATZ RING SET ANILLOS	KOLBEN PISTON PISTONES
HYUNDAI G4GC G4GF Bore Dia. 82.0 mm 4 cyl. 1,975 cc TIBURON TUCSON (01-) DOHC 16V	KBS45000 skirt MOS2 treated	LB45000 length outside diameter flange diameter flange depth	KB45000 length 57.5 comp. height 31.0 +0.3 -3.4 pin = 20.0 x 59.0 circlip not required	KR45000 top 1.2 2nd 1.2 oil 2.5 N-SWG30-028 SW L03-151 R-40832 T-42010	
			23410-23710 23410-23711 23410-23941 23410-23942	23040-23000 23040-23050 23040-23200 23040-23921 23040-23922 23040-23951/2 23040-23953/4 23040-23911 23040-23912 23040-23913	
HYUNDAI G4GF Bore Dia. 82.0 mm 4 cyl. 1,975 cc COUPLE ELANTRA LANTRA TIBURON (96-01) DOHC 16V	KBS72690	LB72690 length outside diameter flange diameter flange depth	KB72690 length 60.9 comp. height 31.0 +1.0 -4.0 pin = 20.0 x 59.0 circlip not required	KR45000 top 1.2 2nd 1.2 oil 2.5 N-SWG30-028 SW L03-151 R-40832 T-42010	
			23410-23210 23410-23921 23410-23922	23040-23000 23040-23050 23040-23200 23040-23921 23040-23922 23040-23951/2 23040-23953/4 23040-23911 23040-23912 23040-23913	
HYUNDAI G4CR Bore Dia. 82.3 mm 4 cyl. 1,596 cc ELANTRA DOHC 16V	KBS72700	LB72700 length outside diameter flange diameter flange depth	KB72700 length 66.0 comp. height 32.5 +1.5 pin = 21.0 x 66.0 circlip not required	KR72700 top 1.2 2nd 1.5 oil 3.0 N-SWG30-021 R-20787 T-42005	
			MD129932 23410-33000 23410-33010 23410-33020 23410-33901 23410-33902 23410-33903 23410-33904	MD133485 MD133495 23040-33000 23040-33030 23040-33901 23040-33902 23040-33903 23040-33904	

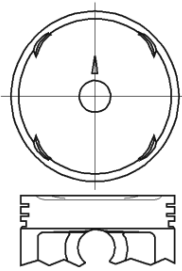
MOTOR - TYP	KOLBEN + RINGE PISTON + RINGS PISTONES + ANILLOS	LAUFBUCHSE CYL. SLEEVE CAMISAS	KOLBENSATZ PISTON SET PISTONES KIT	RINGSATZ RING SET ANILLOS	KOLBEN PISTON PISTONES
HYUNDAI G4JP Bore Dia. 85.0 mm 4 cyl. 1,997 cc SONATA EF DOHC 16V	KBS23000	LB23000 length 150.0 outside diameter 89.0 flange diameter flange depth	length 66.6 comp. height -1.2 -2.7	top 1.2 2nd 1.5 oil 2.8	
			pin = 22.0 x 62.0 circlip not required 23410-38190 23410-38920 23410-38921	N-SWG30-026 R- T-42013 23040-38100 23040-38110 23040-38920 23040-38921 23040-38940 23040-38941	
HYUNDAI Y2 Bore Dia. 85.0 mm 4 cyl. 1,997 cc SONATA (89-98) SOHC 8V	KBS72710	LB72710 length 150.0 outside diameter 89.0 flange diameter flange depth	length 72.4 comp. height 35.4	top 1.5 2nd 1.5 oil 4.0	
			pin = 21.0 x 72.0 circlip not required 23410-32810 23410-32981 23410-32982 23410-32983 23410-32984	N-SWG30-029 R- T- 23040-32800 23040-32820 23040-38910 23040-38912 23040-38913 23040-38914	
HYUNDAI G4CS Bore Dia. 86.5 mm 4 cyl. 2,351 cc SONATA SOHC 8V	KBS72720	LB72720 length 155.0 outside diameter 90.0 flange diameter flange depth	length 72.4 comp. height 35.0 +0.4	top 1.5 2nd 1.5 oil 4.0	
			pin = 21.0 x 72.0 circlip not required 23410-32610 23410-32961 23410-32962 23410-32963 23410-32964	N-SWG30-024 R- T- 23040-32600 23040-32700 23040-32961 23040-32962 23040-32963 23040-32964 23040-32971 23040-32972 23040-32973 23040-32974	

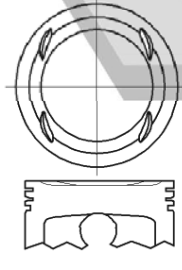
MOTOR - TYP	KOLBEN + RINGE PISTON + RINGS PISTONES + ANILLOS	LAUFBUCHSE CYL. SLEEVE CAMISAS	KOLBENSATZ PISTON SET PISTONES KIT	RINGSATZ RING SET ANILLOS	KOLBEN PISTON PISTONES
HYUNDAI G4JS Bore Dia. 86.5 mm 4 cyl. 2,351 cc KIA OPTIMA H-1 SANTA FE SONATA EF (00-06) DOHC 16V	KBS58000	LB58000 length 155.0 outside diameter 90.0 flange diameter flange depth	KB58000 length 66.7 comp. height 34.7 -2.0 -3.4 pin = 20.0 x 62.0 circlip not required	KR58000 top 1.2 2nd 1.5 oil 2.8 N- R- T- 23410-38290 23040-38200	
			23410-38290	23040-38200	
HYUNDAI 6GBV G6BA Bore Dia. 86.7 mm 6 cyl. 2,657 cc COUPLE SANTA FE SONATA EF TIBURON TRAJET TUCSON (00-06) DOHC 24V	KBS40000	LB40000 length outside diameter flange diameter flange depth 21134-37310	KB40000 length 54.0 comp. height 30.5 -0.8 pin = 21.0 x 60.0 circlip not required	KR40000 top 1.2 2nd 1.2 oil 2.5 N- R- T-42021 23410-37100 23040-37300 23410-37310 23040-37400 23410-37311 23040-37931 23410-37935 23040-37932 23410-37936 23040-37941 23410-37937 23040-37942 23410-37938 23040-3E102	
			23410-37938	23040-37942 23040-3E102	
HYUNDAI 6GCU G6CV Bore Dia. 93.0 mm 6 cyl. 3,497 cc CENTENNIAL GRANDEUR XG SANTA FE TERRCAN XG350 (04-) DOHC 24V	KBS72750	LB72750 length 195.0 outside diameter 97.0 flange diameter flange depth	KB72750 length 54.2 comp. height 31.2 -2.4 -3.0 pin = 22.0 x 64.0 circlip required	KR72750 top 1.5 2nd 1.5 oil 3.0 N- R- T- 23400-39810 23040-39500 23400-39811 23040-39800 23400-39812 23040-39951 23400-39981 23040-39952 23400-39982 23040-39981 23400-39983 23040-39982 23400-39984 23410-39810	
			23400-39810	23040-39500 23040-39800 23040-39951 23040-39952 23040-39981 23040-39982	

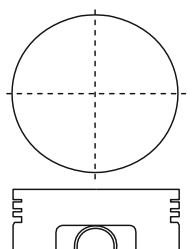
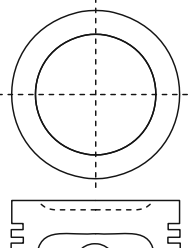
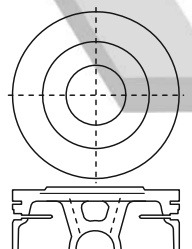
MOTOR - TYP	KOLBEN + RINGE PISTON + RINGS PISTONES + ANILLOS	LAUFBUCHSE CYL. SLEEVE CAMISAS	KOLBENSATZ PISTON SET PISTONES KIT	RINGSATZ RING SET ANILLOS	KOLBEN PISTON PISTONES
ISUZU 4XC1 PAIS-3 Bore Dia. 77.0 mm 4 cyl. 1,471 cc GEMINI I-MARK (85-89) SOHC 8V	KBS72760	LB72760 length outside diameter flange diameter flange depth	KB72760 length 59.0 comp. height 28.6 +0	KR72760 top 1.2 2nd 1.2 oil 2.8	
			pin = 18.0 x 66.0 circlip not required	N-SW110-152/153 R-17680 T-32591	
			8-94109-650-0 8-94162-769-0 8-94162-770-0 8-94162-771-0		
ISUZU 4XC1 Bore Dia. 77.0 mm 4 cyl. 1,471 cc GEMINI I-MARK (85-89) SOHC 8V	KBS72770	LB72770 length outside diameter flange diameter flange depth	KB72770 length 59.0 comp. height 28.5 -0.9	KR72770 top 1.2 2nd 1.2 oil 2.8	
			pin = 18.0 x 63.0 circlip not required	N-SW110-152/153 R-17680 T-32591	
			8-94162-766-0 8-94162-766-2	8-94109-650-0 8-94162-769-0 8-94162-770-0 8-94162-771-0	
ISUZU 4XC1 Bore Dia. 77.0 mm 4 cyl. 1,471 cc GEMINI I-MARK (85-89) SOHC 8V	KBS72771	LB72771 length outside diameter flange diameter flange depth	KB72771 length 59.5 comp. height 28.5 +0.5	KR72771 top 1.5 2nd - oil 2.8	
			pin = 18.0 x 61.0 circlip not required	N-SW110-151 R-17006 T-32590	
			8-94141-426-0	8-94141-947-0	

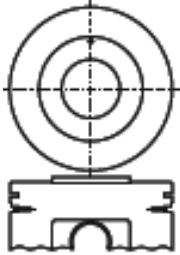
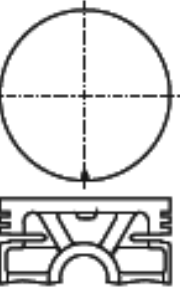
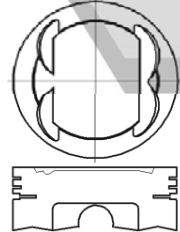
MOTOR - TYP	KOLBEN + RINGE PISTON + RINGS PISTONES + ANILLOS	LAUFBUCHSE CYL. SLEEVE CAMISAS	KOLBENSATZ PISTON SET PISTONES KIT	RINGSATZ RING SET ANILLOS	KOLBEN PISTON PISTONES		
ISUZU 4XC1 Bore Dia. 77.0 mm 4 cyl. 1,471 cc GEMINI I-MARK (85-89) SOHC 8V	KBS72772	LB72772	length	length 62.5	top 1.5		
			outside diameter	comp. height +0.5	2nd -		oil 2.8
			flange diameter	pin = 18.0 x 62.8 circlip not required	N-SWI10-151 R-17006 T-32590		
			flange depth	8-94141-420-0 8-94251-076-1 8-94425-275-0	8-94141-947-0		
ISUZU G150 Bore Dia. 79.0 mm 4 cyl. 1,471 cc BELLET ELF 1500 SOHC 8V	KBS72780	LB72780	length	length 80.0	top 2.0		
			outside diameter	comp. height +0	2nd 2.0		oil 4.0
			flange diameter	pin = 22.0 x 66.0 circlip required	N- R-17450 T-32513		
			flange depth	9-12111-312-0 9-12111-811-0	9-12181-055-0 9-12181-071-0		
ISUZU 4XE1 Bore Dia. 80.0 mm 4 cyl. 1,588 cc 383CID STYLUS RLR (90-91) SOHC 12V	KBS72790	LB72790	length	length 62.0	top 1.2		
			outside diameter	comp. height -1.0	2nd 1.2		oil 3.0
			flange diameter	pin = 18.0 x 63.0 circlip not required	N-SWI10-149 R- T-		
			flange depth	8-94372-479-0 8-94372-480-0 8-94455-400-2 8-97066-885-0 8-97066-969-0 8-97066-970-0	8-94331-660-0 8-94370-434-0 8-94379-296-0 8-94379-297-0 8-97011-557-0 8-97011-558-0		

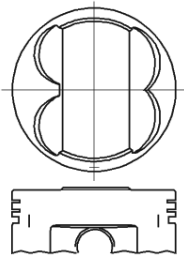
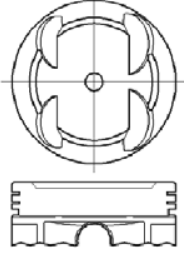
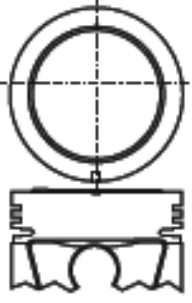
MOTOR - TYP	KOLBEN + RINGE PISTON + RINGS PISTONES + ANILLOS	LAUFBUCHSE CYL. SLEEVE CAMISAS	KOLBENSATZ PISTON SET PISTONES KIT	RINGSATZ RING SET ANILLOS	KOLBEN PISTON PISTONES	
ISUZU 4XE1 PAIS-8 Bore Dia. 80.0 mm 4 cyl. 1,588 cc 350CID STYLUS SOHC 12V	KBS72800	LB72800 length outside diameter flange diameter flange depth	KB72800 length 64.6 comp. height 28.5 +0.7	KR72800 top 1.2 2nd 1.2 oil 3.0		
			pin = 18.0 x 65.8 circlip not required	N-SWI10-149 R- T-		
			8-97066-886-0	8-94331-660-0 8-94370-434-0 8-94379-296-0 8-94379-297-0 8-97011-557-0 8-97011-558-0		
ISUZU 4XF1 Bore Dia. 80.0 mm 4 cyl. 1,809 cc IMPULSE DOHC	KBS72810	LB72810 length outside diameter flange diameter flange depth	KB72810 length 64.0 comp. height 32.5 -1.2 -5.1	KR72810 top 1.2 2nd 1.2 oil 3.0		
			skirt MOS2 treated	pin = 20.0 x 62.2 circlip required		N-SWI10-149 R- T-
				8-97176-808-0		8-94331-660-0 8-94370-434-0 8-94379-296-0 8-94379-297-0 8-97011-557-0 8-97011-558-0
ISUZU G161Z Bore Dia. 82.0 mm 4 cyl. 1,514 cc ELF FLORIAN GEMINI (75-) SOHC 8V	KBS72820	LB72820 length 165.0 outside diameter 86.0 flange diameter flange depth	KB72820 length 80.0 comp. height 37.0 +0.8	KR72820 top 2.0 2nd 2.0 oil 4.0		
				pin = 22.0 x 69.0 circlip not required		N-SWI10-012 R-17580 T-32534
				8-94218-808-0 8-94220-636-0		12121-099 12121-133 12121-141 8-94206-294-0 8-94216-639-0 9-12181-113-0 9-12181-141-0 9-12171-616-0 9-94216-639-0

2012 NEW

ISUZU

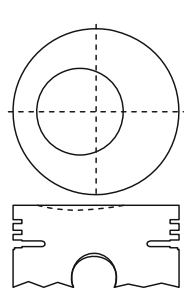
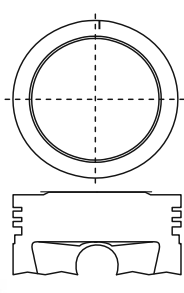
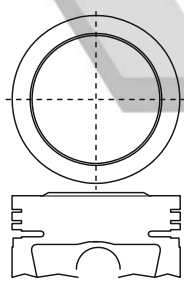
MOTOR - TYP	KOLBEN + RINGE PISTON + RINGS PISTONES + ANILLOS	LAUFBUCHSE CYL. SLEEVE CAMISAS	KOLBENSATZ PISTON SET PISTONES KIT	RINGSATZ RING SET ANILLOS	KOLBEN PISTON PISTONES
ISUZU G161 Bore Dia. 82.0 mm 4 cyl. 1,514 cc ELF FLORIAN GEMINI (75-) SOHC 8V	KBS72830	LB72830 length 165.0 outside diameter 86.0 flange diameter flange depth	KB72830 length 80.0 comp. height 37.0 -2.5 pin = 22.0 x 69.0 circlip required 9-12111-670-0 9-12111-784-0	KR72830 top 2.0 2nd 2.0 oil 4.0 N-SWI10-012 R-17580 T-32534 12121-099 12121-133 12121-141 8-94206-294-0 8-94216-639-0 9-12181-113-0 9-12181-141-0 9-12181-616-0 9-94216-639-0	
ISUZU G161Z Bore Dia. 82.0 mm 4 cyl. 1,514 cc ELF FLORIAN GEMINI (75-) SOHC 8V	KBS72840	LB72840 length 165.0 outside diameter 86.0 flange diameter flange depth	KB72840 length 80.5 comp. height 37.0 +0.5 pin = 22.0 x 69.0 circlip not required 8-94200-645-0 8-94211-129-0	KR72840 top 2.0 2nd 2.0 oil 4.0 N-SWI10-012 R-17580 T-32534 12121-099 12121-133 12121-141 8-94206-294-0 8-94216-639-0 9-12181-113-0 9-12181-141-0 9-12181-616-0 9-94216-639-0	
ISUZU G161 II Bore Dia. 82.0 mm 4 cyl. 1,514 cc ELF FLORIAN GEMINI (75-) SOHC 8V	KBS72850	LB72850 length 165.0 outside diameter 86.0 flange diameter flange depth	KB72850 length 80.5 comp. height 37.0 +0.5 pin = 22.0 x 69.0 circlip not required 8-94244-402-0	KR72850 top 1.5 2nd 1.5 oil 4.0 N-SWI10-097 R-17260/ 17275 T-32570/ 32605 8-94130-293-0 8-94244-403-0 8-94313-198-0 8-94313-199-0 8-94452-743-0 9-94244-403-0 9-94452-743-1	

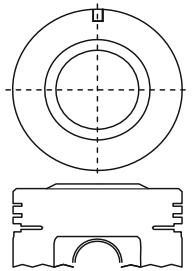
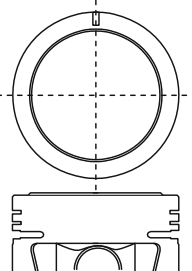
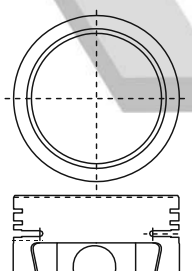
MOTOR - TYP	KOLBEN + RINGE PISTON + RINGS PISTONES + ANILLOS	LAUFBUCHSE CYL. SLEEVE CAMISAS	KOLBENSATZ PISTON SET PISTONES KIT	RINGSATZ RING SET ANILLOS	KOLBEN PISTON PISTONES
ISUZU 4ZA1 Bore Dia. 82.0 mm 4 cyl. 1,584 cc L17 TFR TFS-LHD (92-95) SOHC 8V	KBS72860	LB72860 length 165.0 outside diameter 86.0 flange diameter flange depth	KB72860 length 80.5 comp. height 36.9 +2.5 pin = 22.0 x 69.0 circlip not required 8-94313-635-1 8-94315-643-1 8-94452-742-1	KR72860 top 1.5 2nd 1.5 oil 4.0 N-SW110-097 R-17260/ 17275 T-32570/ 32605 8-94130-293-0 8-94244-403-0 8-94313-198-0 8-94313-199-0 8-94452-743-0 9-94244-403-0 9-94452-743-1	
ISUZU 4ZA1 Bore Dia. 82.0 mm 4 cyl. 1,584 cc TFR SOHC 8V	KBS72861	LB72861 length 165.0 outside diameter 86.0 flange diameter flange depth	KB72861 length 80.6 comp. height 37.0 +0.6 pin = 22.0 x 69.0 circlip not required 8-94232-085-0	KR72861 top 1.5 2nd 1.5 oil 4.0 N-SW110-097 R-17260/ 17275 T-32570/ 32605 8-94130-293-0 8-94244-403-0 8-94313-198-0 8-94313-199-0 8-94452-743-0 9-94244-403-0 9-94452-743-1	
ISUZU G180 G180Z Bore Dia. 84.0 mm 4 cyl. 1,817 cc BELET FLORIAN GEMINI SOHC 8V	KBS72870	LB72870 length 168.0 outside diameter 86.0 flange diameter flange depth	KB72870 length 80.0 comp. height 37.0 -0.8 pin = 22.0 x 66.0 circlip not required 8-94215-088-0	KR72870 top 2.0 2nd 2.0 oil 4.0 N-SCI10-052 SW110-056/087 R-17570 T-32536 5-12181-054-0 8-94208-205-0 8-94216-640-0 8-94224-555-0 9-12181-605-0 9-12181-615-0	

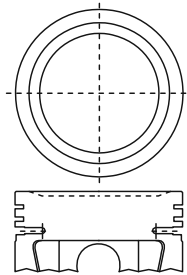
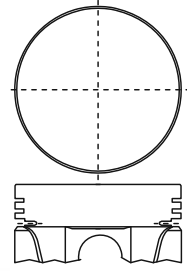
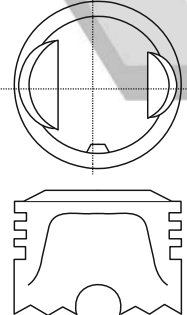
MOTOR - TYP	KOLBEN + RINGE PISTON + RINGS PISTONES + ANILLOS	LAUFBUCHSE CYL. SLEEVE CAMISAS	KOLBENSATZ PISTON SET PISTONES KIT	RINGSATZ RING SET ANILLOS	KOLBEN PISTON PISTONES
ISUZU G180Z Bore Dia. 84.0 mm 4 cyl. 1,817 cc	KBS72880	LB72880 length 168.0 outside diameter 86.0 flange diameter flange depth	KB72880 length 80.0 comp. height 37.0 -2.0 pin = 22.0 x 66.0 circlip not required	KR72880 top 2.0 2nd 2.0 oil 4.0 N-SC110-052 SW110-056/087 R-17570 T-32536	
BELLET FLORIAN GEMINI SOHC 8V					
ISUZU G180S G180SR Bore Dia. 84.0 mm 4 cyl. 1,817 cc	KBS72890	LB72890 length 168.0 outside diameter 86.0 flange diameter flange depth	KB72890 length 80.0 comp. height 37.0 +0 pin = 22.0 x 66.0 circlip required	KR72890 top 2.0 2nd 2.0 oil 4.0 N-SC110-052 SW110-056/087 R-17570 T-32536	
BELLET FLORIAN GEMINI SOHC 8V					
ISUZU G180 G180Z Bore Dia. 84.0 mm 4 cyl. 1,817 cc	KBS72900	LB72900 length 168.0 outside diameter 86.0 flange diameter flange depth	KB72900 length 83.2 comp. height 37.0 +3.2 pin = 22.0 x 66.0 circlip not required	KR72900 top 2.0 2nd 2.0 oil 4.0 N-SC110-052 SW110-056/087 R-17570 T-32536	
BELLET FLORIAN GEMINI SOHC 8V					

ISUZU

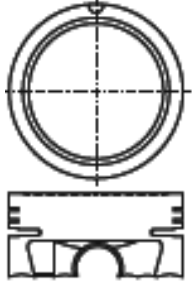
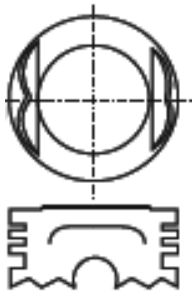
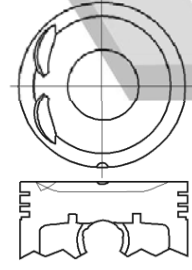
MOTOR - TYP	KOLBEN + RINGE PISTON + RINGS PISTONES + ANILLOS	LAUFBUCHSE CYL. SLEEVE CAMISAS	KOLBENSATZ PISTON SET PISTONES KIT	RINGSATZ RING SET ANILLOS	KOLBEN PISTON PISTONES
ISUZU 4ZB1 G180Z Bore Dia. 84.0 mm 4 cyl. 1,817 cc ASKA MIDI WFR11 (83-90) SOHC 8V	KBS72910	LB72910 length 168.0 outside diameter 86.0 flange diameter flange depth	KB72910 length 80.0 comp. height 37.0 -1.0 pin = 22.0 x 66.0 circlip not required	KR72910 top 1.5 2nd 1.5 oil 4.0 N-SW110-098 R-17000/ 17290 17832 T-32572	
			8-94235-290-0 8-94238-475-0	8-94130-294-0 8-94141-443-0 8-94143-047-1 8-94235-877-0 8-94244-404-0 8-94249-218-0 8-94313-195-0	
ISUZU G180Z Bore Dia. 84.0 mm 4 cyl. 1,817 cc	KBS72920	LB72920 length 168.0 outside diameter 86.0 flange diameter flange depth	KB72920 length 75.5 comp. height 37.0 +0.5 pin = 22.0 x 66.0 circlip not required	KR72920 top 1.5 2nd 1.5 oil 4.0 N-SW110-098 R-17000/ 17290 17832 T-32572	
			8-94251-268-1	8-94130-294-0 8-94141-443-0 8-94143-047-1 8-94235-877-0 8-94244-404-0 8-94249-218-0 8-94313-195-0	
ISUZU X 22 SE Y 22 SE Bore Dia. 86.0 mm 4 cyl. 2,198 cc AMIGO RODEO RODEO SPORT RJL (97-00) DOHC 16V	KBS72930	LB72930 length outside diameter flange diameter flange depth	KB72930 length 55.5 comp. height 30.4 -3.1 -7.5 pin = 21.0 x 61.0 circlip not required	KR72930 top 1.5 2nd 1.5 oil 3.0 N-SW110-205 R-17545 T-32635	
			8-92062-680-0 8-92062-910-0 8-92062-911-0 8-92062-912-0	8-96062-027-0 8-92062-028-0 8-92064-589-0 8-92064-591-0	

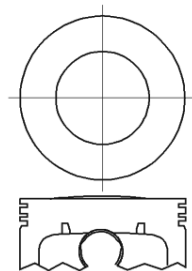
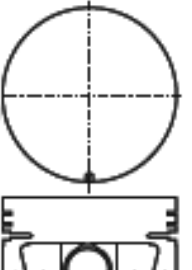
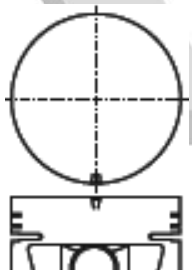
MOTOR - TYP	KOLBEN + RINGE PISTON + RINGS PISTONES + ANILLOS	LAUFBUCHSE CYL. SLEEVE CAMISAS	KOLBENSATZ PISTON SET PISTONES KIT	RINGSATZ RING SET ANILLOS	KOLBEN PISTON PISTONES
ISUZU X 22 SE Y 22 SE Bore Dia. 86.0 mm 4 cyl. 2,198 cc AMIGO RODEO RODEO SPORT RJL (00-03) DOHC 16V	KBS72931	LB72931 length outside diameter flange diameter flange depth	KB72931 length 53.7 comp. height 27.6 +1.2 pin = 21.0 x 61.5 circlip not required	KR72931 top 1.2 2nd 1.5 oil 2.5 N-SWI10-206 R- T- 8-92064-692-0 8-92065-115-0 8-92064-693-0 8-92065-116-0	
			8-92064-692-0 8-92064-693-0	8-92065-115-0 8-92065-116-0	
ISUZU G200Z Bore Dia. 87.0 mm 4 cyl. 1,849 cc PICK UP TROOPER KB28/43 UBS13 (83-84) SOHC 8V	KBS72940	LB72940 length 150.0 outside diameter 91.0 flange diameter flange depth	KB72940 length 80.0 comp. height 37.0 +0 pin = 22.0 x 78.0 circlip not required	KR72940 top 2.0 2nd 2.0 oil 4.0 N-SWI10-084 R-17270 T-32555 8-94213-831-0 8-94216-641-0 8-94271-840-0 8-94271-890-0	
			8-94213-831-0 8-94271-840-0 8-94271-890-0	8-94216-641-0	
ISUZU G200 G200Z Bore Dia. 87.0 mm 4 cyl. 1,849 cc PICK UP LY8 (83-87) SOHC 8V	KBS72950	LB72950 length 150.0 outside diameter 91.0 flange diameter flange depth	KB72950 length 80.05 comp. height 37.0 +0 pin = 22.0 x 78.0 circlip not required	KR72950 top 1.5 2nd 1.5 oil 4.0 N-SWI10-096 R-17007/ 17010 T-32577 8-94237-469-1 8-94130-295-0 8-94247-906-0 8-94231-817-0 8-94247-907-0 8-94248-831-0 8-94248-847-0 8-94438-086-0 8-94447-415-0 8-94455-190-0 8-94455-191-0	
			8-94237-469-1 8-94247-906-0 8-94247-907-0	8-94130-295-0 8-94231-817-0 8-94248-831-0 8-94248-847-0 8-94438-086-0 8-94447-415-0 8-94455-190-0 8-94455-191-0	

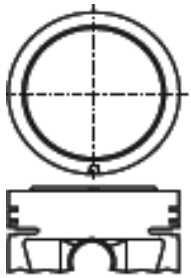
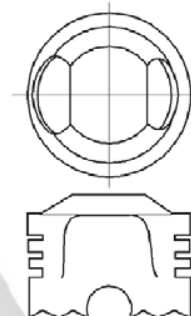
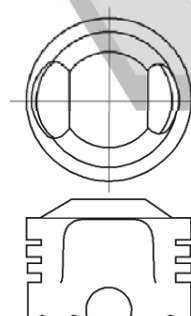
MOTOR - TYP	KOLBEN + RINGE PISTON + RINGS PISTONES + ANILLOS	LAUFBUCHSE CYL. SLEEVE CAMISAS	KOLBENSATZ PISTON SET PISTONES KIT	RINGSATZ RING SET ANILLOS	KOLBEN PISTON PISTONES
ISUZU G200 Bore Dia. 87.0 mm 4 cyl. 1,849 cc	KBS72960	LB72960 length 150.0 outside diameter 91.0 flange diameter flange depth	KB72960 length 80.55 comp. height 37.0 +0.5 pin = 22.0 x 78.0 circlip not required 8-94258-494-1 8-94258-497-1 8-94258-499-1	KR72960 top 1.5 2nd 1.5 oil 4.0 N-SW110-096 R-17007/ 17010 T-32577 8-94130-295-0 8-94231-817-0 8-94248-831-0 8-94248-847-0 8-94438-086-0 8-94447-415-0 8-94455-190-0 8-94455-191-0	
ISUZU G200W Bore Dia. 87.0 mm 4 cyl. 1,849 cc	KBS72970	LB72970 length 150.0 outside diameter 91.0 flange diameter flange depth	KB72970 length 87.7 comp. height 37.0 +7.7 pin = 22.0 x 76.0 circlip not required 8-94237-082-0 8-94237-082-1	KR72970 top 1.5 2nd 1.5 oil 4.0 N-SW110-096 R-17007/ 17010 T-32577 8-94130-295-0 8-94231-817-0 8-94248-831-0 8-94248-847-0 8-94438-086-0 8-94447-415-0 8-94455-190-0 8-94455-191-0	
ISUZU G200W Bore Dia. 87.0 mm 4 cyl. 1,849 cc	KBS72971	LB72971 length 150.0 outside diameter 91.0 flange diameter flange depth	KB72971 length 88.0 comp. height 37.0 +8.0 pin = 22.0 x 76.0 circlip not required 8-94107-912-0	KR72971 top 1.5 2nd 1.5 oil 4.0 N-SW110-096 R-17007/ 17010 T-32577 8-94130-295-0 8-94231-817-0 8-94248-831-0 8-94248-847-0 8-94438-086-0 8-94447-415-0 8-94455-190-0 8-94455-191-0	

MOTOR - TYP	KOLBEN + RINGE PISTON + RINGS PISTONES + ANILLOS	LAUFBUCHSE CYL. SLEEVE CAMISAS	KOLBENSATZ PISTON SET PISTONES KIT	RINGSATZ RING SET ANILLOS	KOLBEN PISTON PISTONES
ISUZU 4ZC1 Bore Dia. 88.0 mm 4 cyl. 1,994 cc ASKA IMPULSE VAN WAGON WFR MICRO BUS LR9 WFR-LHD/RHD (83-93) SOHC 8V	KBS72980	LB72980	length 80.0	top 1.5	
			outside diameter	comp. height 37.0 -2.0	
ISUZU 4ZC1 Bore Dia. 88.0 mm 4 cyl. 1,994 cc IMPULSE SOHC 8V	KBS72981	LB72981	length 80.0	top 1.5	
			outside diameter	comp. height 37.0 -3.5	
ISUZU 4ZC1 Bore Dia. 88.0 mm 4 cyl. 1,994 cc MIDI VAN 4WD 94170 98170 98370 WFR12 WFS12 (85-88) SOHC 8V	KBS72982	LB72982	length 75.0	top 1.5	
			outside diameter	comp. height 37.0 -1.5	
		flange diameter	pin = 22.0 x 69.0 circlip not required	N-SWI10-133 R-17420 T-32573	
			flange depth	8-94175-087-2 8-94224-314-0 8-94414-055-1 8-94414-056-1	
		flange diameter	pin = 22.0 x 69.0 circlip not required	N-SWI10-133 R-17420 T-32573	
			flange depth	8-94143-151-3	
		flange diameter	pin = 22.0 x 69.0 circlip not required	N-SWI10-133 R-17420 T-32573	
			flange depth	8-94250-916-1	

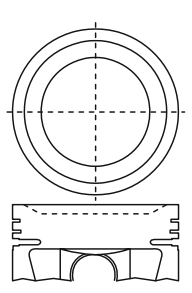
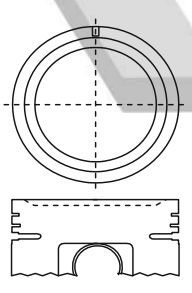
MOTOR - TYP	KOLBEN + RINGE PISTON + RINGS PISTONES + ANILLOS	LAUFBUCHSE CYL. SLEEVE CAMISAS	KOLBENSATZ PISTON SET PISTONES KIT	RINGSATZ RING SET ANILLOS	KOLBEN PISTON PISTONES
ISUZU 4ZD1 Bore Dia. 89.3 mm 4 cyl. 2,254 cc 138CID AMIGO ASKA CAMPO 4WD IMPULSE PICK UP TROOPER TFR16 TFS16 UCS16 UBS16 (86-89) SOHC 8V	KBS72990	LB72990 length 150.0 outside diameter 93.3 flange diameter flange depth	KB72990 length 81.0 comp. height 39.0 -5.0 pin = 23.0 x 70.0 circlip not required 8-94156-657-0 8-94413-459-0	KR72990 top 1.5 2nd 1.5 oil 4.0 N-SW110-123/161 R-17670/ 17675 T-32579 8-94136-778-0 8-94136-778-1 8-94153-966-0 8-94153-966-1 8-94153-966-2 8-94337-245-1 8-94337-296-1 8-94411-549-0 8-94411-550-0 8-94416-220-0 8-94416-221-0	
ISUZU 4ZD1 Bore Dia. 89.3 mm 4 cyl. 2,254 cc 138CID PICK UP CALIFORNIA EMISSION SYSTEM (NB7) VIN-4 LW3 (93-94) SOHC 8V	KBS72992	LB72992 length 150.0 outside diameter 93.3 flange diameter flange depth	KB72992 length 80.9 comp. height 39.0 -3.3 pin = 23.0 x 72.0 circlip not required 8-97080-597-1 8-97084-113-1 8-97084-114-1	KR72992 top 1.5 2nd 1.5 oil 4.0 N-SW110-123/161 R-17670/ 17675 T-32579 8-94136-778-0 8-94136-778-1 8-94153-966-0 8-94153-966-1 8-94153-966-2 8-94337-245-1 8-94337-296-1 8-94411-549-0 8-94411-550-0 8-94416-220-0 8-94416-221-0	

MOTOR - TYP	KOLBEN + RINGE PISTON + RINGS PISTONES + ANILLOS	LAUFBUCHSE CYL. SLEEVE CAMISAS	KOLBENSATZ PISTON SET PISTONES KIT	RINGSATZ RING SET ANILLOS	KOLBEN PISTON PISTONES
ISUZU 4ZE1 Bore Dia. 92.6 mm 4 cyl. 2,559 cc AMIGO PICK UP TROOPER RLG RLJ (87-92) SOHC 8V	KBS73000	LB73000	length 78.9	top 1.5	
			outside diameter	comp. height 36.5 -1.3	
ISUZU 4ZE1 Bore Dia. 92.6 mm 4 cyl. 2,559 cc AMIGO PICK UP RLJ (92-) SOHC 8V	KBS73001	LB73001	length 79.0	top 1.5	
			outside diameter	comp. height 36.5 -4.3	
ISUZU 6VD1 Bore Dia. 93.4 mm 4 cyl. 3,165 cc RODEO TROOPER SOHC	KBS73010	LB73010	length 65.2	top 1.5	
			outside diameter	comp. height 31.7 -5.1	
		flange diameter	pin = 23.0 x 79.8 circlip not required	N-SW110-144/162 R-17590/ 17595 T-32594/ 32596	
		flange depth	8-94163-189-1 8-94163-189-2 8-94163-189-3 8-94319-522-0 8-94319-523-0	8-94320-180-0 8-94320-181-0 8-94337-249-0 8-94337-250-0 8-94405-614-0 8-94405-614-2 8-94446-957-1	
		flange diameter	pin = 23.0 x 77.0 circlip not required	N-SW110-144/162 R-17590/ 17595 T-32594/ 32596	
		flange depth	8-97037-801-0 8-97037-801-1 8-97069-548-1	8-94320-180-0 8-94320-181-0 8-94337-249-0 8-94337-250-0 8-94405-614-0 8-94405-614-2 8-94446-957-1	
		flange diameter	pin = 22.0 x 66.0 circlip not required	N-SW110-185 R-17983 T-32614	
		flange depth	8-97104-386-0 8-97176-812-0 8-97176-813-0 8-97176-814-0	8-97127-562-0 8-97162-198-0 8-97307-372-0	



ISUZU

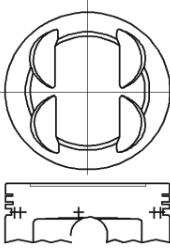
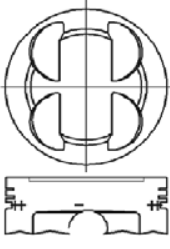
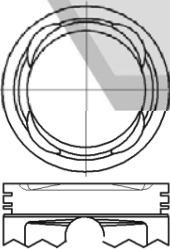

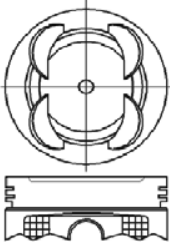
2012 NEW

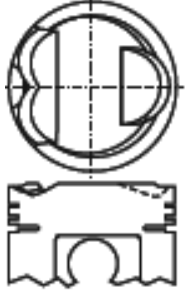
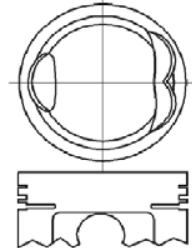
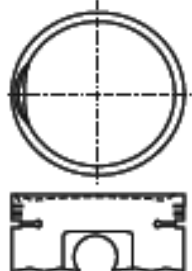
MOTOR - TYP	KOLBEN + RINGE PISTON + RINGS PISTONES + ANILLOS	LAUFBUCHSE CYL. SLEEVE CAMISAS	KOLBENSATZ PISTON SET PISTONES KIT	RINGSATZ RING SET ANILLOS	KOLBEN PISTON PISTONES
ISUZU 6VD1 Bore Dia. 93.4 mm 6 cyl. 3,165 cc 193CID TROOPER VCROSS WIZARD USG25 (97-99) DOHC 24V	KBS73011	LB73011 length 177.8 outside diameter 97.4 flange diameter flange depth	KB73011 length 65.3 comp. height 31.8 -0.7 pin = 22.0 x 66.0 circlip not required	KR73011 top 1.5 2nd 1.5 oil 4.0 N-SWI10-185 R-17983 T-32614 8-94374-965-1 9-12211-034-1 8-97127-562-0 8-97162-198-0 8-97307-372-0	
			8-94374-965-1 9-12211-034-1	8-97127-562-0 8-97162-198-0 8-97307-372-0	
ISUZU 6VD1 Bore Dia. 93.4 mm 6 cyl. 3,165 cc 193CID TROOPER VCROSS WINZARD UGS25 (97-99) DOHC 24V	KBS73012	LB73012 length 177.8 outside diameter 97.4 flange diameter flange depth	KB73012 length 65.1 comp. height 31.7 -0.7 pin = 22.0 x 66.0 circlip not required	KR73012 top 1.5 2nd 1.5 oil 4.0 N-SWI10-185 R-17983 T-32614 8-94386-427-1 8-97127-588-0 8-97127-562-0 8-97162-198-0 8-97307-372-0	
			8-94386-427-1 8-97127-588-0	8-97127-562-0 8-97162-198-0 8-97307-372-0	
ISUZU 6VE1 Bore Dia. 93.4 mm 6 cyl. 3,494 cc 213CID AXIOM TROOPER RJQ (01- 03) DOHC 24V	KBS73020	LB73020 length 215.0 outside diameter 97.4 flange diameter flange depth	KB73020 length 52.7 comp. height 29.7 -3.0 pin = 22.0 x 66.0 circlip not required	KR73020 top 1.5 2nd 1.5 oil 3.0 N-SWI10-191 R- T-32629 8-97136-315-3 8-97167-093-2 8-97167-094-2	
			8-97136-315-3 8-97167-093-2 8-97167-094-2	8-97136-135-0 8-97170-113-0	

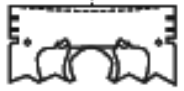
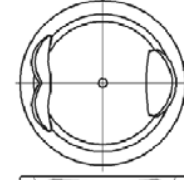
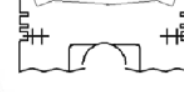
MOTOR - TYP	KOLBEN + RINGE PISTON + RINGS PISTONES + ANILLOS	LAUFBUCHSE CYL. SLEEVE CAMISAS	KOLBENSATZ PISTON SET PISTONES KIT	RINGSATZ RING SET ANILLOS	KOLBEN PISTON PISTONES
ISUZU 6VE1 Bore Dia. 93.4 mm 6 cyl. 3,494 cc 213CID AXIOM TROOPER RJQ (01- 03) DOHC 24V	KBS73021	LB73021 length 215.0 outside diameter 97.4 flange diameter flange depth	KB73021 length 57.0 comp. height 33.7 -2.2	KR73021 top 1.2 2nd 1.2 oil 2.0	
			pin = 22.0 x 66.0 circlip not required	N- R- T-32628	
			8-97180-192-0	8-97371-535-0	
ISUZU 6VD1 Bore Dia. 93.4 mm 6 cyl. 3,166 cc AMIGO RODEO DOHC	KBS73030	LB73030 length outside diameter flange diameter flange depth	KB73030 length 57.0 comp. height 33.7 -2.0 -3.6	KR73030 top 1.5 2nd 1.5 oil 3.0	
			pin = 22.0 x 66.0 circlip not required	N-SWI10-191 R- T-32629	
			8-97172-674-0 8-97172-675-0 8-97172-676-0	8-97136-135-0 8-97170-113-0	
					2012 NEW
		length outside diameter flange diameter flange depth	length comp. height	top 2nd oil	
			pin = x	N- R- T-	

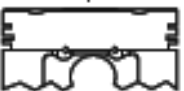
MOTOR - TYP	KOLBEN + RINGE PISTON + RINGS PISTONES + ANILLOS	LAUFBUCHSE CYL. SLEEVE CAMISAS	KOLBENSATZ PISTON SET PISTONES KIT	RINGSATZ RING SET ANILLOS	KOLBEN PISTON PISTONES
KIA B1 Bore Dia. 68.0 mm 4 cyl. 1,139 cc	KBS73040	LB73040	KB73040	KR73040	
PRIDE (97-98) SOHC 8V		length outside diameter flange diameter flange depth	pin = 20.0 x 52.0 circlip not required KK1Y8-11-SAO KK1Y8-11-SBO KK1Y8-11-SBX KK1Y8-11-SBY	N-SWK30-018/24 SW L03-088 R-40486 T-43002 KK1Y-11-SCO KKY1-11-SCO KK1Y8-11-SCO KK1YH-11-SDX KK1YV-11-SCO KK1YV-11-SDO KK1YV-11-SDX KK1YV-11-SDY	
KIA B3 Bore Dia. 71.0 mm 4 cyl. 1,324 cc	KBS73050	LB73050	KB73050	KR73050	
PRIDE (97-99) SOHC 8V		length outside diameter flange diameter flange depth	pin = 20.0 x 52.0 circlip not required KK1Y0-11-102 KK1Y0-11-SAO KK1Y0-11-SBO KK1Y0-11-SBX KK1Y0-11-SBY KK1Y0-11-SBZ	N-SWK30-017 SW L03-048 R-40011 / 40738 T-43008 K1Y0-11-SCO K1Y1-11-SCO K1YH-11-SCO KK1Y1-11-SCO KK1Y1-11-SDO KK1Y1-11-SDX KK1Y1-11-SDY KK1Y1-11-SDZ	
KIA A3E Bore Dia. 75.5 mm 4 cyl. 1,343 cc	KBS73060	LB73060	KB73060	KR73060	
RIO (00-05) SOHC 8V		length outside diameter flange diameter flange depth	pin = 20.0 x 53.0 circlip not required OK3Y-11-5AO OK3Y0-11-5AO OK3Y0-11-SAO OK3Y0-11-SBO OK3Y0-11-SBX	N-SWK30-019 SW L03-147 R-40880 T-43012 K3Y0-11-SCO OK3Y0-11-SCO OK3Y0-11-SDO OK3Y0-11-SDX OK3Y2-11-SCO OK3Y2-11-SDO OK3Y2-11-SDX	

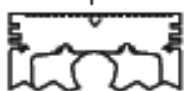
MOTOR - TYP	KOLBEN + RINGE PISTON + RINGS PISTONES + ANILLOS	LAUFBUCHSE CYL. SLEEVE CAMISAS	KOLBENSATZ PISTON SET PISTONES KIT	RINGSATZ RING SET ANILLOS	KOLBEN PISTON PISTONES
KIA A5D A5E Bore Dia. 75.5 mm 4 cyl. 1,493 cc RIO (00-04) DOHC 16V	KBS66500	LB66500 length outside diameter flange diameter flange depth	length 51.3 comp. height 28.3 -1.3 -2.3	top 1.2 2nd 1.2 oil 2.5	 
			pin = 20.0 x 52.0 circlip not required OK3Y2-11-SAO OK3Y2-11-SBO OK3Y2-11-SBX	N-SWK30-019 SWL03-147 R-40880 T-43012 K3Y0-11-SCO OK3Y0-11-SCO OK3Y0-11-SDO OK3Y0-11-SDX OK3Y2-11-SCO OK3Y2-11-SDO OK3Y2-11-SDX	
KIA B6E Bore Dia. 78.0 mm 4 cyl. 1,597 cc SEPHIA (92-) SOHC 16V	KBS73080	LB73080 length outside diameter flange diameter flange depth	length 63.0 comp. height 31.9 -4.3	top 1.5 2nd 1.5 oil 4.0	 
			pin = 20.0 x 65.0 circlip not required K9Y1-11-SCO	N-SWK30-020 R-41320 T-43015	
KIA B6D Bore Dia. 78.0 mm 4 cyl. 1,597 cc SEPHIA DOHC 16V	KBS73090	LB73090 length outside diameter flange diameter flange depth	length 63.0 comp. height 31.4 -0.6	top 1.5 2nd 1.5 oil 3.0	 
			pin = 20.0 x 61.0 circlip not required K2Y2-11-SCO K2YA-11-SCO OK2Y2-11-SCO OK2Y2-11-SDO OK2Y2-11-SDX OK2YA-11-SCO	N-SWT20-063 R-41195 T-	

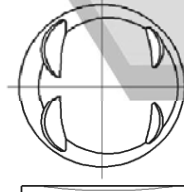
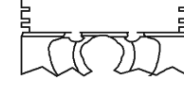
MOTOR - TYP	KOLBEN + RINGE PISTON + RINGS PISTONES + ANILLOS	LAUFBUCHSE CYL. SLEEVE CAMISAS	KOLBENSATZ PISTON SET PISTONES KIT	RINGSATZ RING SET ANILLOS	KOLBEN PISTON PISTONES		
KIA A6D Bore Dia. 78.0 mm 4 cyl. 1,597 cc RIO (00-05) DOHC 16V	KBS73100	LB73100	length	length 48.3	top 1.2	 	
			outside diameter	comp. height 28.3 -0.8 -1.6	2nd 1.2		oil 2.5
			flange diameter	pin = 20.0 x 53.0 circlip not required	N- R- T-		
			flange depth	23410-2X710 23410-2X905 23410-2X906	OK3Y3-11-SCO OK3Y3-11-SDO OK3Y3-11-SDX		
KIA TED Bore Dia. 81.0 mm 4 cyl. 1,793 cc SHUMA (98-) DOHC 16V	KBS73110	LB73110	length	length 50.3	top 1.2	 	
			outside diameter	comp. height 30.2 -2.6	2nd 1.2		oil 2.5
			flange diameter	pin = 20.0 x 52.0 circlip required	N- R- T-		
			flange depth	23410-2Y010			
KIA T8 Bore Dia. 81.0 mm 4 cyl. 1,793 cc CLARUS (96-00) DOHC 16V	KBS73120	LB73120	length	length 50.5	top 1.5	 	
			outside diameter	comp. height 30.3 -2.6	2nd 1.5		oil 3.0
			flange diameter	pin = 20.0 x 58.5 circlip required	N- R- T-		
			flange depth	OK2Y4-11-SAO OK2Y4-11-SBX OK2Y4-11-SBO	K2Y3-11-SDX OK2Y3-11-SCO OK2Y3-11-SDX OK2Y3-11-SDO		

KIA

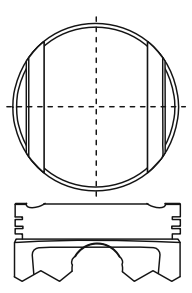
MOTOR - TYP	KOLBEN + RINGE PISTON + RINGS PISTONES + ANILLOS	LAUFBUCHSE CYL. SLEEVE CAMISAS	KOLBENSATZ PISTON SET PISTONES KIT	RINGSATZ RING SET ANILLOS	KOLBEN PISTON PISTONES
KIA KRV6 Bore Dia. 80.0 mm 6 cyl. 2,497 cc CARNIVAL (98-05) DOHC 24V	KBS67500	LB67500	KB67500	KR67500	
		length 127.0 outside diameter 84.0 flange diameter 87.45 collar height 50.0 OK9BV-10-311A 21134-3Y210C 21134-3Y210D 21134-3Y210E 21134-3Y220C 21134-3Y220D 21134-3Y220E 21134-3Y250C 21134-3Y250D 21134-3Y250E	length 50.2 comp. height 27.3 -1.4 pin = 18.0 x 54.7 circlip not required K9YV-11-SAO OK9YV-11-SAO OK9YV-11-SAOC OK9YV-11-SAOD OK9YV-11-SAOE	top 1.2 2nd 1.5 oil 2.5 N-SWK30-025 R- T-	
		length outside diameter flange diameter flange depth	length comp. height pin = x	top 2nd oil N- R- T-	
		length outside diameter flange diameter flange depth	length comp. height pin = x	top 2nd oil N- R- T-	

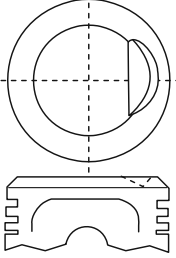
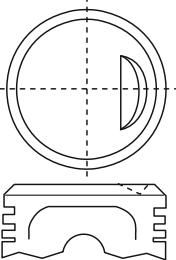
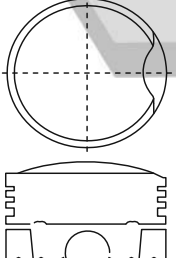
MOTOR - TYP	KOLBEN + RINGE PISTON + RINGS PISTONES + ANILLOS	LAUFBUCHSE CYL. SLEEVE CAMISAS	KOLBENSATZ PISTON SET PISTONES KIT	RINGSATZ RING SET ANILLOS	KOLBEN PISTON PISTONES
MAZDA PB Bore Dia. 68.0 mm 4 cyl. 987 cc BONGO VAN FAMILIA SOHC 8V	KBS73140	LB73140 length 125.0 outside diameter 77.0 flange diameter 88.0 flange depth 8.5 0249-10-311	KB73140 length 73.9 comp. height 37.6 +4.3 pin = 20.0 x 56.0 circlip required	KR73140 top 2.0 2nd 2.0 oil 4.0 N-SXT20-006 R-30530 T-33715	
			0249-11-102 0249-99-111 0259-23-200	0249-23-170A 0249-23-206 0259-23-170 0259-23-170A 0259-23-206 0259-23-260	
MAZDA TB Bore Dia. 70.0 mm 4 cyl. 1,169 cc FAMILIA PREST SOHC 8V	KBS32000	LB32000 length 132.0 outside diameter 77.0 flange diameter 88.0 flange depth 8.5 0268-10-311 0271-23-206	KB32000 length 71.0 comp. height 37.0 +2.0 pin = 20.0 x 56.0 circlip required	KR32000 top 2.0 2nd 2.0 oil 4.0 N-SNT20-019 SX T20-009 R-30560/ 30600 T-33711	
			0268-11-102 0268-23-200 0271-23-200	0211-23-999 0268-23-170 0268-23-170A 0268-23-206 0317-23-130 0317-23-175	
MAZDA PC Bore Dia. 70.0 mm 4 cyl. 985 cc 323 FAMILIA (77-83) SOHC 8V	KBS73160	LB73160 length outside diameter flange diameter flange depth	KB73160 length 74.5 comp. height 36.8 +5.7 pin = 20.0 x 56.0 circlip required	KR73160 top 2.0 2nd 2.0 oil 4.0 N-SNT20-019 SX T20-009 R-30560/ 30600 T-33711	
			0317-23-200	0211-23-999 0268-23-170 0268-23-170A 0268-23-206 0317-23-130 0317-23-175	

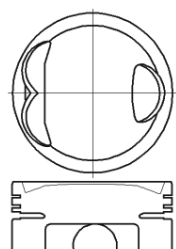
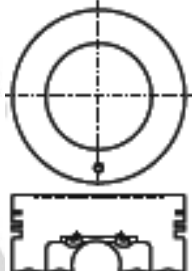
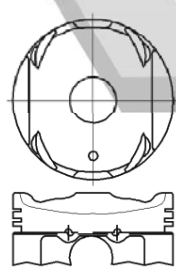

MOTOR - TYP	KOLBEN + RINGE PISTON + RINGS PISTONES + ANILLOS	LAUFBUCHSE CYL. SLEEVE CAMISAS	KOLBENSATZ PISTON SET PISTONES KIT	RINGSATZ RING SET ANILLOS	KOLBEN PISTON PISTONES		
MAZDA B3 Bore Dia. 71.0 mm 4 cyl. 1,324 cc 121 323 (87-89) SOHC 8V	KBS73170	LB73170	length	length 60.0	top 1.2		
			outside diameter	comp. height 28.8 -4.7	2nd 1.5		oil 3.0
			flange diameter	pin = 20.0 x 52.0 circlip not required	N-SWT20-052 R-30142/ 30150 T-33757		
			flange depth	B315-11-102 B3Y0-11-SAO B3Y0-11-SBO B3Y0-11-SBX B3Y0-11-SBY B3Y0-11-SBZ	B3Y0-11-SCOA B3Y1-11-SCO B3Y1-11-SCOA B3Y1-11-SDO B3Y1-11-SDOA B3Y1-11-SDX B3Y1-11-SDXA B3Y1-11-SDY B3Y1-11-SDYA B3Y1-11-SDZ/ZA		
MAZDA B3 Bore Dia. 71.0 mm 4 cyl. 1,324 cc 121 323 SOHC 8V	KBS73171	LB73171	length	length 59.6	top 1.2		
			outside diameter	comp. height 28.9 -1.1	2nd 1.5		oil 3.0
			flange diameter	pin = 20.0 x 52.0 circlip not required	N-SWT20-052 R-30142/ 30150 T-33757		
			flange depth	B367-11-102 B3Y4-11-102	B3Y0-11-SCOA B3Y1-11-SCO B3Y1-11-SCOA B3Y1-11-SDO B3Y1-11-SDOA B3Y1-11-SDX B3Y1-11-SDXA B3Y1-11-SDY B3Y1-11-SDYA B3Y1-11-SDZ/ZA		
MAZDA B3 Bore Dia. 71.0 mm 4 cyl. 1,324 cc 121 323 (90-95) SOHC 16V	KBS73172	LB73172	length	length 60.0	top 1.2		
			outside diameter	comp. height 29.4 -9.5	2nd 1.5		oil 3.0
			flange diameter	pin = 20.0 x 52.0 circlip not required	N-SWT20-052 R-30142/ 30150 T-33757		
			flange depth	B3C7-11-102 B3Y6-11-SAO/OA B3Y6-11-SAOB/OC B3Y6-11-SBO/OA B3Y6-11-SBOB/OC B3Y6-11-SBX/XA B3Y6-11-SBXC/XC B3Y6-11-SBY/YA B3Y6-11-SBZ/YB/YC B3Y6-11-SBZA/ZB/ZC	B3Y0-11-SCOA B3Y1-11-SCO B3Y1-11-SCOA B3Y1-11-SDO B3Y1-11-SDOA B3Y1-11-SDX B3Y1-11-SDXA B3Y1-11-SDY B3Y1-11-SDYA B3Y1-11-SDZ/ZA		

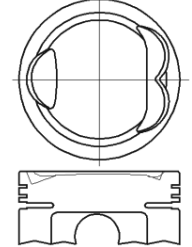
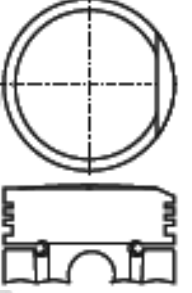
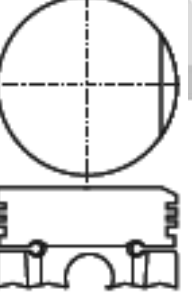
MOTOR - TYP	KOLBEN + RINGE PISTON + RINGS PISTONES + ANILLOS	LAUFBUCHSE CYL. SLEEVE CAMISAS	KOLBENSATZ PISTON SET PISTONES KIT	RINGSATZ RING SET ANILLOS	KOLBEN PISTON PISTONES
MAZDA B3 Bore Dia. 71.0 mm 4 cyl. 1,324 cc 121 323 SOHC 8V	KBS73173	LB73173 length outside diameter flange diameter flange depth	KB73173 length 60.0 comp. height 28.8 -5.6	KR73173 top 1.2 2nd 1.5 oil 3.0	
			pin = 20.0 x 52.0 circlip not required	N-SWT20-052 R-30142/ 30150 T-33757	
			MB3H7-11-102	B3Y0-11-SCOA B3Y1-11-SCO B3Y1-11-SCOA B3Y1-11-SDO B3Y1-11-SDOA B3Y1-11-SDX B3Y1-11-SDXA B3Y1-11-SDY B3Y1-11-SDYA B3Y1-11-SDZ/ZA	
MAZDA TC Bore Dia. 73.0 mm 4 cyl. 1,272 cc 323 FAMILIA (70-78) SOHC 8V	KBS73180	LB73180 length outside diameter flange diameter flange depth	KB73180 length 70.4 comp. height 37.1 +1.4	KR73180 top 2.0 2nd 2.0 oil 4.0	
			pin = 20.0 x 56.0 circlip required	N-SWT20-026 R-30590 T-33717	
			O370-23-200 O370-99-111	O324-23-130 O324-23-175	
MAZDA TC Bore Dia. 73.0 mm 4 cyl. 1,272 cc 323 FAMILIA (70-78) SOHC 8V	KBS73181	LB73181 length outside diameter flange diameter flange depth	KB73181 length 69.0 comp. height 37.1 +0	KR73181 top 2.0 2nd 2.0 oil 4.0	
			pin = 20.0 x 56.0 circlip required	N-SWT20-026 R-30590 T-33717	
			O324-23-200 O324-99-111	O324-23-130 O324-23-175	

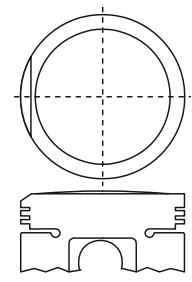
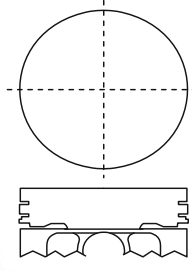

MOTOR - TYP	KOLBEN + RINGE PISTON + RINGS PISTONES + ANILLOS	LAUFBUCHSE CYL. SLEEVE CAMISAS	KOLBENSATZ PISTON SET PISTONES KIT	RINGSATZ RING SET ANILLOS	KOLBEN PISTON PISTONES	
MAZDA TC New Bore Dia. 73.0 mm 4 cyl. 1,272 cc 323 BONGO (77-83) SOHC 8V	KBS73190	LB73190	length	length 64.3	top 1.5	
			outside diameter	comp. height 31.0 +1.3	2nd 1.5	
			flange diameter	pin = 20.0 x 56.0 circlip not required	oil 4.0	
			flange depth	8034-23-200	N-SWT20-033 R-30050/ 30770 T-33739 8034-23-130 8034-23-130A	
MAZDA J4D JJA JJB Bore Dia. 73.97mm 4 cyl. 1,297 cc 121 (96-02) SOHC 8V	KBS73200	LB73200	length	length 53.9	top 1.5	
			outside diameter	comp. height 29.4 +0	2nd 1.75	
			flange diameter	pin = 18.0 x 64.0 circlip not required	oil 3.0	
			flange depth		N- R- T-	
MAZDA ZJ Bore Dia. 74.0 mm 4 cyl. 1,348 cc 2 3 (03- 06) DOHC 16V	KBS60500	LB60500	length	length	top 1.2	
			outside diameter	comp. height	2nd 1.2	
			flange diameter	pin = x	oil 2.5	
			flange depth	ZJY1-11-SAO ZJY1-11-SAOA ZJY2-11-SAOA	N- R- T- ZJY1-11-SCO ZJY2-11-SCO	

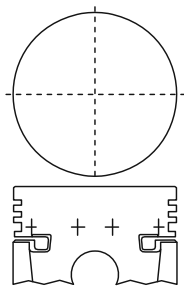
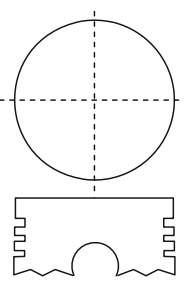
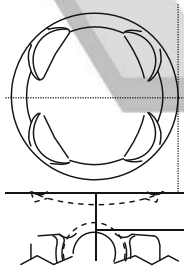
MOTOR - TYP	KOLBEN + RINGE PISTON + RINGS PISTONES + ANILLOS	LAUFBUCHSE CYL. SLEEVE CAMISAS	KOLBENSATZ PISTON SET PISTONES KIT	RINGSATZ RING SET ANILLOS	KOLBEN PISTON PISTONES
MAZDA UA Bore Dia. 75.0 mm 4 cyl. 1,484 cc B1500 (65-71) OHV 8V	KBS73220	LB73220 length 147.5 outside diameter 86.5 flange diameter 94.0 flange depth 9.0 0604-10-311	KB73220 length 78.0 comp. height 41.0 +0	KR73220 top 2.5 2nd 2.5 oil 4.0	
			pin = 22.0 x 65.0 circlip required	N-SCT20-010 R-30490 T-33724	
			0107-11-102 0603-23-200	0107-11-999 0603-23-170 0603-23-170A 0603-23-999	
MAZDA UA New Bore Dia. 75.0 mm 4 cyl. 1,484 cc B1500 (65-71) OHV 8V	KBS73230	LB73230 length 147.5 outside diameter 86.5 flange diameter 94.0 flange depth 9.0 0604-10-311	KB73230 length 78.0 comp. height 41.0 +0	KR73230 top 2.0 2nd 2.0 oil 4.0	
			pin = 22.0 x 65.0 circlip required	N- R-30690 T-33726	
			0571-23-200 0572-23-200	0571-23-170 0571-23-180	
MAZDA Z5-DE Bore Dia. 75.3 mm 4 cyl. 1,489 cc 323 PROTEGE (94-96) DOHC 16V	KBS73240	LB73240 length outside diameter flange diameter flange depth	KB73240 length 51.8 comp. height 28.0 -6.3	KR73240 top 1.0 2nd 1.2 oil 2.5	
			pin = 20.0 x 61.0 circlip not required	N-SWT20-074 R-30001 / 30990 T-	
			Z5Y0-11-SAO Z5Y0-11-SAOA Z5Y0-11-SAOB Z5Y0-11-SBO Z5Y0-11-SBOA Z5Y0-11-SBOB Z5Y0-11-SBX Z5Z0-11-SBXA Z5Z0-11-SBXB	Z5Y0-11-SCO Z5Y0-11-SDO Z5Y0-11-SDX Z5Z0-11-SCO Z5Z0-11-SDO Z5Z0-11-SDX	

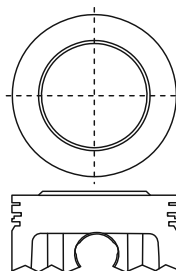
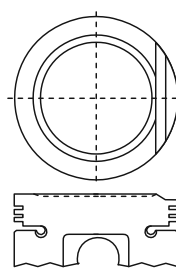
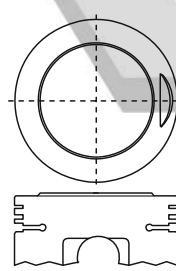
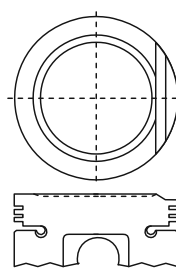
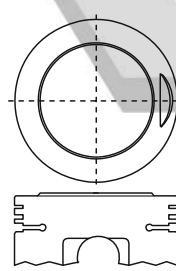
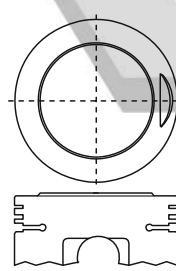

MOTOR - TYP	KOLBEN + RINGE PISTON + RINGS PISTONES + ANILLOS	LAUFBUCHSE CYL. SLEEVE CAMISAS	KOLBENSATZ PISTON SET PISTONES KIT	RINGSATZ RING SET ANILLOS	KOLBEN PISTON PISTONES																																																																											
MAZDA C4 Bore Dia. 76.0 mm 4 cyl. 1,388 cc 2 3 (03-) SOHC 16V	KBS73250	LB73250	KB73250	KR73250		length	length 54.25	top 1.2			outside diameter	comp. height 28.25 +1.22	2nd 1.5				flange diameter	pin = 19.0 x 47.0 circlip required	oil 2.5				flange depth		N- R- T-		MAZDA UC Bore Dia. 77.0 mm 4 cyl. 1,415 cc E1400 FAMILIA (78-80) SOHC 8V	KBS73260	LB73260	KB73260	KR73260		length	length 63.0	top 1.5			outside diameter	comp. height 31.0 -1.2	2nd 1.5				flange diameter	pin = 20.0 x 65.0 circlip not required	oil 4.0				flange depth	8569-23-200	N-SWT20-036 R-30260/ 30760 T-33741 8569-23-130 8569-23-130A		MAZDA E3 Bore Dia. 77.0 mm 4 cyl. 1,296 cc 323 (85-87) SOHC 8V	KBS73270	LB73270	KB73270	KR73270		length	length 61.7	top 1.5			outside diameter	comp. height 29.0 +0.8	2nd 2.0				flange diameter	pin = 20.0 x 65.0 circlip not required	oil 4.0				flange depth	E302-11-102A E302-23-200 E302-23-200A E302-23-210A E302-23-220A	N-SWT20-045 R-30015/ 30245 30961 T-33750 E302-23-130A E302-23-131A E302-23-132A	
						length	length 54.25	top 1.2																																																																								
		outside diameter	comp. height 28.25 +1.22	2nd 1.5																																																																												
		flange diameter	pin = 19.0 x 47.0 circlip required	oil 2.5																																																																												
		flange depth		N- R- T-																																																																												
MAZDA UC Bore Dia. 77.0 mm 4 cyl. 1,415 cc E1400 FAMILIA (78-80) SOHC 8V	KBS73260	LB73260	KB73260	KR73260		length	length 63.0	top 1.5			outside diameter	comp. height 31.0 -1.2	2nd 1.5				flange diameter	pin = 20.0 x 65.0 circlip not required	oil 4.0				flange depth	8569-23-200	N-SWT20-036 R-30260/ 30760 T-33741 8569-23-130 8569-23-130A		MAZDA E3 Bore Dia. 77.0 mm 4 cyl. 1,296 cc 323 (85-87) SOHC 8V	KBS73270	LB73270	KB73270	KR73270		length	length 61.7	top 1.5			outside diameter	comp. height 29.0 +0.8	2nd 2.0				flange diameter	pin = 20.0 x 65.0 circlip not required	oil 4.0				flange depth	E302-11-102A E302-23-200 E302-23-200A E302-23-210A E302-23-220A	N-SWT20-045 R-30015/ 30245 30961 T-33750 E302-23-130A E302-23-131A E302-23-132A																												
						length	length 63.0	top 1.5																																																																								
		outside diameter	comp. height 31.0 -1.2	2nd 1.5																																																																												
		flange diameter	pin = 20.0 x 65.0 circlip not required	oil 4.0																																																																												
		flange depth	8569-23-200	N-SWT20-036 R-30260/ 30760 T-33741 8569-23-130 8569-23-130A																																																																												
MAZDA E3 Bore Dia. 77.0 mm 4 cyl. 1,296 cc 323 (85-87) SOHC 8V	KBS73270	LB73270	KB73270	KR73270		length	length 61.7	top 1.5			outside diameter	comp. height 29.0 +0.8	2nd 2.0				flange diameter	pin = 20.0 x 65.0 circlip not required	oil 4.0				flange depth	E302-11-102A E302-23-200 E302-23-200A E302-23-210A E302-23-220A	N-SWT20-045 R-30015/ 30245 30961 T-33750 E302-23-130A E302-23-131A E302-23-132A																																																							
						length	length 61.7	top 1.5																																																																								
		outside diameter	comp. height 29.0 +0.8	2nd 2.0																																																																												
		flange diameter	pin = 20.0 x 65.0 circlip not required	oil 4.0																																																																												
		flange depth	E302-11-102A E302-23-200 E302-23-200A E302-23-210A E302-23-220A	N-SWT20-045 R-30015/ 30245 30961 T-33750 E302-23-130A E302-23-131A E302-23-132A																																																																												

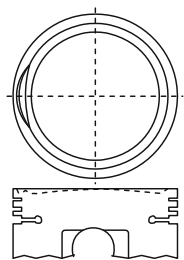
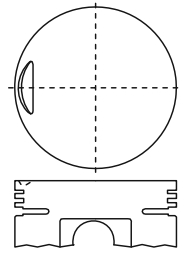
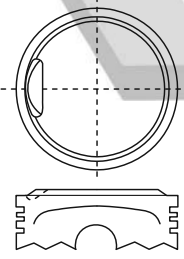
MOTOR - TYP	KOLBEN + RINGE PISTON + RINGS PISTONES + ANILLOS	LAUFBUCHSE CYL. SLEEVE CAMISAS	KOLBENSATZ PISTON SET PISTONES KIT	RINGSATZ RING SET ANILLOS	KOLBEN PISTON PISTONES
MAZDA E5 Bore Dia. 77.0 mm 4 cyl. 1,490 cc 323 (85-87) SOHC 8V	KBS73280	LB73280 length outside diameter flange diameter flange depth	length 61.0 comp. height 29.0 -0.5 pin = 20.0 x 65.0 circlip not required E502-11-102A E502-23-200 E502-23-200A E502-23-210A E502-23-220A	top 1.5 2nd 2.0 oil 4.0 N-SWT20-045 R-30015/ 30245 30961 T-33750 E302-23-130A E302-23-131A E302-23-132A	
			length 60.9 comp. height 29.0 +0	top 1.5 2nd 2.0 oil 4.0 N-SWT20-045 R-30015/ 30245 30961 T-33750 E580-23-200C E302-23-130A E302-23-131A E302-23-132A	
			length 61.8 comp. height 29.0 +0.8	top 1.2 2nd 1.5 oil 4.0 N-SWT20-037 R-30025/ 30030 30210 / 30605 T-33743 E301-23-130 E301-23-130A E512-23-130	
			length 61.8 comp. height 29.0 +0.8	top 1.2 2nd 1.5 oil 4.0 N-SWT20-037 R-30025/ 30030 30210 / 30605 T-33743 E301-23-130 E301-23-130A E512-23-130	
MAZDA E5 Bore Dia. 77.0 mm 4 cyl. 1,490 cc 323 (85-87) SOHC 8V	KBS73290	LB73290 length outside diameter flange diameter flange depth	length 60.9 comp. height 29.0 +0	top 1.5 2nd 2.0 oil 4.0 N-SWT20-045 R-30015/ 30245 30961 T-33750 E580-23-200C E302-23-130A E302-23-131A E302-23-132A	
			length 61.8 comp. height 29.0 +0.8	top 1.2 2nd 1.5 oil 4.0 N-SWT20-037 R-30025/ 30030 30210 / 30605 T-33743 E301-23-130 E301-23-130A E512-23-130	
			length 61.8 comp. height 29.0 +0.8	top 1.2 2nd 1.5 oil 4.0 N-SWT20-037 R-30025/ 30030 30210 / 30605 T-33743 E301-23-130 E301-23-130A E512-23-130	
			length 61.8 comp. height 29.0 +0.8	top 1.2 2nd 1.5 oil 4.0 N-SWT20-037 R-30025/ 30030 30210 / 30605 T-33743 E301-23-130 E301-23-130A E512-23-130	
MAZDA E3 Bore Dia. 77.0 mm 4 cyl. 1,296 cc 323 (85-87) SOHC 8V	KBS73300	LB73300 length outside diameter flange diameter flange depth	length 61.8 comp. height 29.0 +0.8	top 1.2 2nd 1.5 oil 4.0 N-SWT20-037 R-30025/ 30030 30210 / 30605 T-33743 E301-23-130 E301-23-130A E512-23-130	
			length 61.8 comp. height 29.0 +0.8	top 1.2 2nd 1.5 oil 4.0 N-SWT20-037 R-30025/ 30030 30210 / 30605 T-33743 E301-23-130 E301-23-130A E512-23-130	
			length 61.8 comp. height 29.0 +0.8	top 1.2 2nd 1.5 oil 4.0 N-SWT20-037 R-30025/ 30030 30210 / 30605 T-33743 E301-23-130 E301-23-130A E512-23-130	
			length 61.8 comp. height 29.0 +0.8	top 1.2 2nd 1.5 oil 4.0 N-SWT20-037 R-30025/ 30030 30210 / 30605 T-33743 E301-23-130 E301-23-130A E512-23-130	

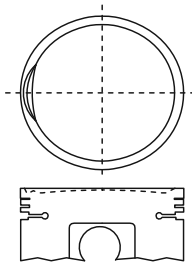
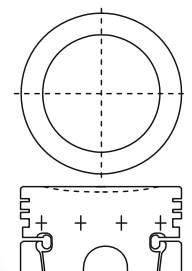
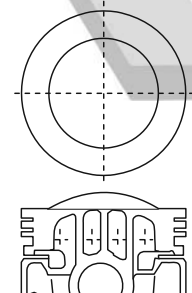

MOTOR - TYP	KOLBEN + RINGE PISTON + RINGS PISTONES + ANILLOS	LAUFBUCHSE CYL. SLEEVE CAMISAS	KOLBENSATZ PISTON SET PISTONES KIT	RINGSATZ RING SET ANILLOS	KOLBEN PISTON PISTONES
MAZDA E5 Bore Dia. 77.0 mm 4 cyl. 1,490 cc 323 (85-87) SOHC 8V	KBS73310	LB73310 length outside diameter flange diameter flange depth	KB73310 length 61.0 comp. height 29.0 -2.2 -2.4	KR73310 top 1.2 2nd 1.5 oil 4.0	
			pin = 20.0 x 65.0 circlip not required	N-SWT20-037 R-30025/ 30030 30210 / 30605 T-33743	
			E501-23-200	E301-23-130 E301-23-130A E512-23-130	
MAZDA VB Bore Dia. 78.0 mm 4 cyl. 1,796 cc 618 626 929 B1800 FORD TRUCK (68-77) SOHC 8V	KBS73320	LB73320 length 146.0 outside diameter 82.0 flange diameter flange depth 305-23-208	KB73320 length 76.9 comp. height 39.9 -2.8	KR73320 top 1.5 2nd 1.5 oil 4.0	
			pin = 22.0 x 65.6 circlip required	N-SWT20-025 R-30100/ 30570 T-33719	
			0290-23-200 3879-23-200	0222-23-206 0222-23-130 0290-23-130 0290-23-131 0305-23-130 0484-23-130 0494-23-130 3763-23-130 D27Z-6149 D77Z-6108	
MAZDA VB Bore Dia. 78.0 mm 4 cyl. 1,796 cc 618 626 929 B1800 FORD TRUCK (68-77) SOHC 8V	KBS73321	LB73321 length 146.0 outside diameter 82.0 flange diameter flange depth 305-23-208	KB73321 length 82.0 comp. height 37.0 +8.0	KR73321 top 1.5 2nd 1.5 oil 4.0	
			pin = 22.0 x 65.0 circlip required	N-SWT20-025 R-30100/ 30570 T-33719	
			D272-6108B	0222-23-206 0222-23-130 0290-23-130 0290-23-131 0305-23-130 0484-23-130 0494-23-130 3763-23-130 D27Z-6149 D77Z-6108	

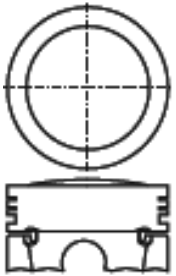
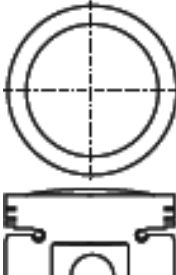
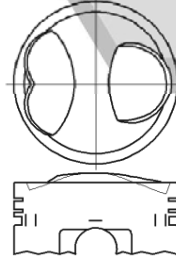
MOTOR - TYP	KOLBEN + RINGE PISTON + RINGS PISTONES + ANILLOS	LAUFBUCHSE CYL. SLEEVE CAMISAS	KOLBENSATZ PISTON SET PISTONES KIT	RINGSATZ RING SET ANILLOS	KOLBEN PISTON PISTONES
MAZDA NA Bore Dia. 78.0 mm 4 cyl. 1,586 cc 626 B1600 CAPELLA E1600 (71-) SOHC 8V	KBS73330	LB73330 length 146.0 outside diameter 82.0 flange diameter flange depth 305-23-208	KB73330 length 78.2 comp. height 38.4 +2.8 pin = 22.0 x 65.0 circlip required	KR73330 top 1.5 2nd 1.5 oil 4.0 N-SWT20-025 R-30100/ 30570 T-33719 0222-23-206 0222-23-130 0290-23-130 0290-23-131 0305-23-130 0484-23-130 0494-23-130 3763-23-130 D27Z-6149 D77Z-6108	
			0305-11-102 0305-23-200 0305-23-200A		
MAZDA NA New Bore Dia. 78.0 mm 4 cyl. 1,586 cc 626 B1600 CAPELLA E1600 (71-) SOHC 8V	KBS73340	LB73340 length 146.0 outside diameter 82.0 flange diameter flange depth 305-23-208	KB73340 length 78.2 comp. height 38.4 +2.8 pin = 20.0 x 65.0 circlip required	KR73340 top 1.2 2nd 1.5 oil 4.0 N-SWT20-035 R-30070/ 30820 T-33742 8170-23-200 8170-23-200A H601-23-200 8170-23-130 8170-23-130A 8658-23-130 H604-23-130	
			8170-23-200 8170-23-200A H601-23-200		
MAZDA B6 Bore Dia. 78.0 mm 4 cyl. 1,597 cc 323 (85-) SOHC 8V	KBS13500	LB13500 length 150.0 outside diameter 82.0 flange diameter flange depth	KB13500 length 67.3 comp. height 31.9 +4.2 pin = 20.0 x 66.0 circlip not required	KR13500 top 1.5 2nd 1.5 oil 4.0 N-SWT20-060 R-30845 T- B6Y0-11-SCO B6Y0-11-SCOA B6Y0-11-SDO B6Y0-11-SDOA B6Y0-11-SDX B6Y0-11-SDXA B6Y0-11-SIOA B6Y1-11-SCO	
			BY61-11-SAO		



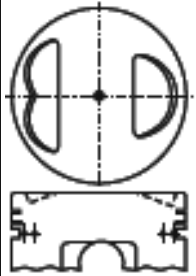
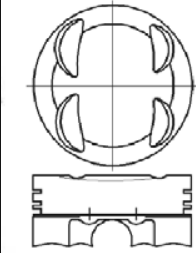
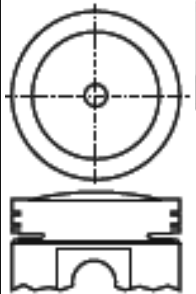

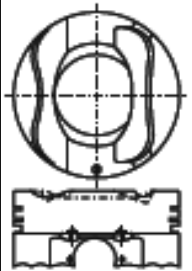
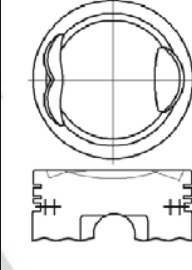
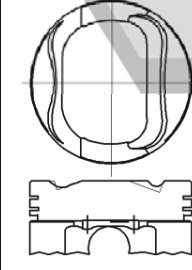
MOTOR - TYP	KOLBEN + RINGE PISTON + RINGS PISTONES + ANILLOS	LAUFBUCHSE CYL. SLEEVE CAMISAS	KOLBENSATZ PISTON SET PISTONES KIT	RINGSATZ RING SET ANILLOS	KOLBEN PISTON PISTONES
MAZDA B5 Bore Dia. 78.0 mm 4 cyl. 1,498 cc 323 (87-89) SOHC 8V	KBS96790	LB96790 length outside diameter flange diameter flange depth	length 63.5 comp. 31.9 height -3.9 -5.3	top 1.5 2nd 1.5 oil 4.0	
			pin = 20.0 x 65.0 circlip not required B505-11-102B B5Y1-11-SAO B5Y5-11-SAOA B5Y1-11-SBO B5Y1-11-SBOA B5Y1-11-SBX B5Y1-11-SBXA B5Y5-11-AOA	N-SWT20-060 R-30845 T- B6Y0-11-SCO B6Y0-11-SCOA B6Y0-11-SDO B6Y0-11-SDOA B6Y0-11-SDX B6Y0-11-SDXA B6Y0-11-SIOA B6Y1-11-SCO	
MAZDA B6-ZE B6-ME Bore Dia. 78.0 mm 4 cyl. 1,597 cc 323 MX3 (92-94) SOHC 16V	KBS96800	LB96800 length 150.0 outside diameter 82.0 flange diameter flange depth	length 62.5 comp. 32.0 height -2.7 -5.3	top 1.5 2nd 1.5 oil 3.0	
			pin = 20.0 x 57.0 circlip required B6Z5-11-SAO B6Z5-11-SBO B6Z5-11-SBX B6BF-11-102 BP05-11-102	N-SWT20-063 R-30085/ 30865 T-33759 B6Y3-11-SCO B6Y3-11-SCOA B6Y3-11-SDO B6Y3-11-SDX B6Y6-11-SCO B6Y6-11-SDO B6Y6-11-SDX B6Z0-11-SCO B6Z0-11-SDO B6Z0-11-SDX	
MAZDA NA-II Bore Dia. 78.0 mm 4 cyl. 1,586 cc 626 B1600 CAPELLA E1600 SOHC 8V	KBS96810	LB96810 length 146.0 outside diameter 82.0 flange diameter flange depth 305-23-208	length 78.2 comp. 38.5 height +2.7	top 1.5 2nd 2.0 oil 4.0	
			pin = 20.0 x 65.0 circlip not required H602-23-200	N-SWT20-049 S X T20-049 R-30920 T-33746 H617-23-130	

MOTOR - TYP	KOLBEN + RINGE PISTON + RINGS PISTONES + ANILLOS	LAUFBUCHSE CYL. SLEEVE CAMISAS	KOLBENSATZ PISTON SET PISTONES KIT	RINGSATZ RING SET ANILLOS	KOLBEN PISTON PISTONES
MAZDA B6 Bore Dia. 78.0 mm 4 cyl. 1,597 cc 323 (89-91) SOHC 16V	KBS13501	length 150.0 outside diameter 82.0 flange diameter flange depth	length 63.0 comp. height 32.4 -4.5 pin = 20.0 x 61.0 circlip not required	top 1.5 2nd 1.5 oil 3.0 N-SWT20-063 R-30085/ 30865 T-33759	
			BGY2-11-SAO BGY2-11-SBO BGY2-11-SBX	BGY3-11-SCO BGY3-11-SCOA BGY3-11-SDO BGY3-11-SDX BGY6-11-SCO BGY6-11-SDO BGY6-11-SDX B6Z0-11-SCO B6Z0-11-SDO B6Z0-11-SDX	
MAZDA B6 Bore Dia. 78.0 mm 4 cyl. 1,597 cc 323 (85-89) SOHC 8V	KBS13502	length 150.0 outside diameter 82.0 flange diameter flange depth	length 63.0 comp. height 31.9 -4.3 pin = 20.0 x 65.0 circlip not required	top 1.5 2nd 1.5 oil 4.0 N-SWT20-060 R-30845 T-	
			B630-11-102 B6Y0-11-SAO B6Y0-11-SAOA B6Y0-11-SBO B6Y0-11-SBX B6Y1-11-SAO B6Y1-11-SBD B6Y1-11-SBX	B6Y0-11-SCO B6Y0-11-SCOA B6Y0-11-SDO B6Y0-11-SDOA B6Y0-11-SDX B6Y0-11-SDXA B6Y0-11-SIOA B6Y1-11-SCO	
MAZDA B6 Bore Dia. 78.0 mm 4 cyl. 1,597 cc 323 (89-) SOHC 16V	KBS13503	length 150.0 outside diameter 82.0 flange diameter flange depth	length 63.0 comp. height 32.4 -4.3 pin = 20.0 x 61.0 circlip not required	top 1.5 2nd 1.5 oil 3.0 N-SWT20-063 R-30085/ 30865 T-33759	
				B6Y3-11-SCO B6Y3-11-SCOA B6Y3-11-SDO B6Y3-11-SDX B6Y6-11-SCO B6Y6-11-SDO B6Y6-11-SDX B6Z0-11-SCO B6Z0-11-SDO B6Z0-11-SDX	

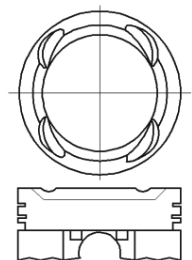
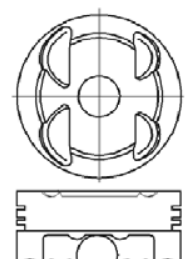
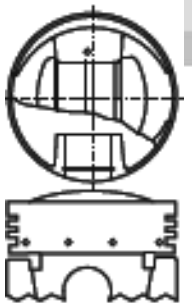

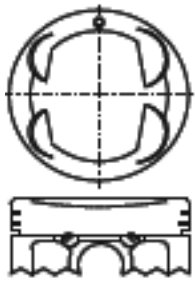
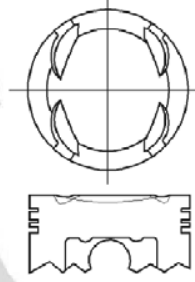
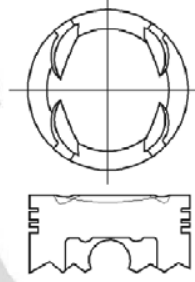
MOTOR - TYP	KOLBEN + RINGE PISTON + RINGS PISTONES + ANILLOS	LAUFBUCHSE CYL. SLEEVE CAMISAS	KOLBENSATZ PISTON SET PISTONES KIT	RINGSATZ RING SET ANILLOS	KOLBEN PISTON PISTONES
MAZDA B6T Bore Dia. 78.0 mm 4 cyl. 1,597 cc 323 (87) DOHC 16V	KBS96820	LB96820 length 150.0 outside diameter 82.0 flange diameter flange depth	KB96820 length 63.5 comp. height 32.2 -5.6 pin = 20.0 x 61.5 circlip required	KR96820 top 1.5 2nd 1.5 oil 4.0 N-SWT20-060 R-30845 T-	
			B6ZO-11-SAO B6ZO-11-SAOB B6ZO-11-SAOC B6ZO-11-SBOB B6ZO-11-SBOC B6ZO-11-SBXB B6ZO-11-SBXC	B6YO-11-SCO B6YO-11-SCOA B6YO-11-SDO B6YO-11-SDOA B6YO-11-SDX B6YO-11-SDXA B6YO-11-SIOA B6Y1-11-SCO	
MAZDA B5 Bore Dia. 78.0 mm 4 cyl. 1,498 cc FAMILIA MX-3 (89-94) DOHC 16V	KBS96830	LB96830 length outside diameter flange diameter flange depth	KB96830 length 63.0 comp. height 31.9 -0.9 pin = 20.0 x 61.0 circlip not required	KR96830 top 1.5 2nd 1.5 oil 3.0 N-SWT20-063 R-30085/ 30865 T-33759	
			B552-11-102	B6Y3-11-SCO B6Y3-11-SCOA B6Y3-11-SDO B6Y3-11-SDX B6Y6-11-SCO B6Y6-11-SDO B6Y6-11-SDX B6ZO-11-SCO B6ZO-11-SDO B6ZO-11-SDX	
MAZDA UB Bore Dia. 78.0 mm 4 cyl. 1,490 cc 626 929 SOHC 8V	KBS96840	LB96840 length outside diameter flange diameter flange depth	KB96840 length 83.0 comp. height 41.0 +5.0 pin = 22.0 x 65.0 circlip required	KR96840 top 2.0 2nd 2.0 oil 4.0 N-SWT20-011 R- T-33714	
			0222-11-102B 0223-12-200	0222-23-130 0222-23-206	

MOTOR - TYP	KOLBEN + RINGE PISTON + RINGS PISTONES + ANILLOS	LAUFBUCHSE CYL. SLEEVE CAMISAS	KOLBENSATZ PISTON SET PISTONES KIT	RINGSATZ RING SET ANILLOS	KOLBEN PISTON PISTONES				
MAZDA ZL-VE Bore Dia. 78.0 mm 4 cyl. 1,498 cc 323 (98) DOHC 16V	KBS63000	LB63000 length outside diameter flange diameter flange depth	length 54.0 comp. height 30.6 -1.6 pin = 20.0 x 61.0 circlip not required ZLY2-11-SAO ZLY2-11-SBO ZLY2-11-SBX	top 1.2 2nd 1.5 oil 3.0 N-SWT20-080 R-30002 T- ZLYO-11-SCO ZLYO-11-SDO ZLYO-11-SDX					
			length 150.0	length 62.4		top 1.5			
			outside diameter 82.0	comp. height 31.9 -2.6		2nd 1.5			
			flange diameter	pin = 20.0 x 57.0 circlip required		oil 3.0			
flange depth B6Z7-11-SAO B6Z7-11-SAOA B6Z7-11-SBO B6Z7-11-SBOA B6Z7-11-SBX B6Z7-11-SBXA	N-SWT20-063 R-30085 / 30865 T-33759 B6Y3-11-SCO B6Y3-11-SCOA B6Y3-11-SDO B6Y3-11-SDX B6Y6-11-SCO B6Y6-11-SDO B6Y6-11-SDX B6Z0-11-SCO B6Z0-11-SDO B6Z0-11-SDX								
MAZDA B6 Bore Dia. 78.0 mm 4 cyl. 1,597 cc 323 (94-96) MX-3 (93-) DOHC 16V	KBS13504		LB13504 length 150.0 outside diameter 82.0 flange diameter flange depth	length 62.4 comp. height 31.9 -2.6 pin = 20.0 x 57.0 circlip required B6Z7-11-SAO B6Z7-11-SAOA B6Z7-11-SBO B6Z7-11-SBOA B6Z7-11-SBX B6Z7-11-SBXA	top 1.5 2nd 1.5 oil 3.0 N-SWT20-063 R-30085 / 30865 T-33759 B6Y3-11-SCO B6Y3-11-SCOA B6Y3-11-SDO B6Y3-11-SDX B6Y6-11-SCO B6Y6-11-SDO B6Y6-11-SDX B6Z0-11-SCO B6Z0-11-SDO B6Z0-11-SDX				
MAZDA Z 6-DE ZM-ME Bore Dia. 78.0 mm 4 cyl. 1,598 cc 3 (03-06) DOHC 16V				KBS96860	LB96860 length 150.0 outside diameter 82.0 flange diameter flange depth		length 48.3 comp. height 29.8 -1.9 pin = 20.0 x 58.0 circlip not required Z6Y1-11-SAO Z6Y1-11-SAOA Z6Y1-11-SAOB	top 1.2 2nd 1.2 oil 2.5 N- R-30090 T- ZYY1-11-SCO ZYY2-11-SCO	
length 150.0							length 48.3	top 1.2	
outside diameter 82.0		comp. height 29.8 -1.9					2nd 1.2		
flange diameter	pin = 20.0 x 58.0 circlip not required	oil 2.5							
flange depth	Z6Y1-11-SAO Z6Y1-11-SAOA Z6Y1-11-SAOB	N- R-30090 T- ZYY1-11-SCO ZYY2-11-SCO							

MAZDA

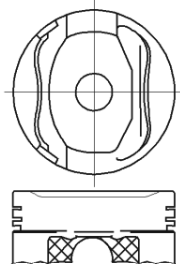
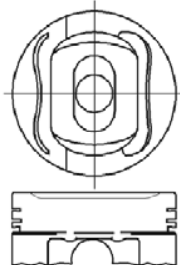
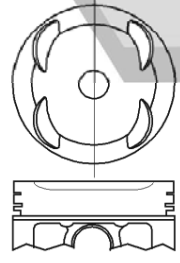
MOTOR - TYP	KOLBEN + RINGE PISTON + RINGS PISTONES + ANILLOS	LAUFBUCHSE CYL. SLEEVE CAMISAS	KOLBENSATZ PISTON SET PISTONES KIT	RINGSATZ RING SET ANILLOS	KOLBEN PISTON PISTONES
MAZDA B6 Bore Dia. 78.0 mm 4 cyl. 1,597 cc CT-20	KBS13505	LB13505	length 63.0	top 1.5	
			outside diameter 32.4	2nd 1.5	
			height -3.0	oil 3.0	
			pin = 20.0 x 61.0 circlip not required	N-SWT20-063 R-30085 / 30865 T-33759	
			B62A-11-102	B6Y3-11-SCO B6Y3-11-SCOA B6Y3-11-SDO B6Y3-11-SDX B6Y6-11-SCO B6Y6-11-SDO B6Y6-11-SDX B6Z0-11-SCO B6Z0-11-SDO B6Z0-11-SDX	
					2012 NEW
MAZDA B6 Bore Dia. 78.0 mm 4 cyl. 1,597 cc CT-20 LASER	KBS13506	LB13506	length 63.0	top 1.5	
			outside diameter 32.4	2nd 1.5	
			height -2.3 -4.9	oil 3.0	
			pin = 20.0 x 61.0 circlip not required	N-SWT20-063 R-30085 / 30865 T-33759	
			B67K-11-102	B6Y3-11-SCO B6Y3-11-SCOA B6Y3-11-SDO B6Y3-11-SDX B6Y6-11-SCO B6Y6-11-SDO B6Y6-11-SDX B6Z0-11-SCO B6Z0-11-SDO B6Z0-11-SDX	
					2012 NEW
MAZDA ZM Bore Dia. 78.0 mm 4 cyl. 1,597 cc C206	KBS16500	LB16500	length 54.5	top 1.2	
			outside diameter 31.0	2nd 1.5	
			height -3.85	oil 3.0	
			pin = 20.0 x 61.0 circlip not required	N-SWT20-080 R-30002 T-	
			DZM01-11-102	ZLY0-11-SCO ZLY0-11-SDO ZLY0-11-SDX	
					2012 NEW

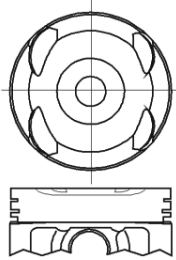
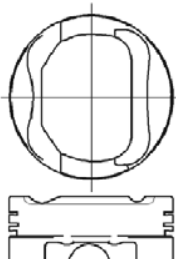
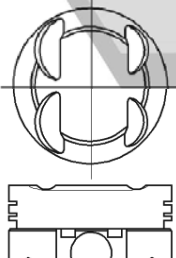
MOTOR - TYP	KOLBEN + RINGE PISTON + RINGS PISTONES + ANILLOS	LAUFBUCHSE CYL. SLEEVE CAMISAS	KOLBENSATZ PISTON SET PISTONES KIT	RINGSATZ RING SET ANILLOS	KOLBEN PISTON PISTONES
MAZDA ZM Bore Dia. 78.0 mm 4 cyl. 1,598 cc 323 PROTEGE DOHC 16V	KBS16501	length outside diameter flange diameter flange depth	length 54.5 comp. height 31.0 -3.85	top 1.2 2nd 1.5 oil 3.0	
			pin = 20.0 x 61.0 circlip not required	N-SWT20-080 R-30002 T-	
			ZMYO-11-SAO ZMYO-11-SBO ZMYO-11-SBX	ZLYO-11-SCO ZLYO-11-SDO ZLYO-11-SDX	
			2012 NEW		
MAZDA B6 Bore Dia. 78.0 mm 4 cyl. 1,597 cc 323 MX-3 (91-) SOHC 16V	KBS13507	length outside diameter flange diameter flange depth	length 62.4 comp. height 31.9 -2.4	top 1.5 2nd 1.5 oil 3.0	
			pin = 20.0 x 61.0 circlip not required	N-SWT20-063 R-30085 / 30865 T-33759	
			B6Y3-11-SAO B6Y3-11-SAOA B6Y3-11-SBO B6Y3-11-SBOA B6Y3-11-SBX B6Y3-11-SBXA	B6Y3-11-SCO B6Y3-11-SCOA B6Y3-11-SDO B6Y3-11-SDX B6Y6-11-SCO B6Y6-11-SDO B6Y6-11-SDX B6Z0-11-SCO B6Z0-11-SDO B6Z0-11-SDX	
			2012 NEW		
MAZDA B6-ZE Bore Dia. 78.0 mm 4 cyl. 1,598 cc MX-5 (90-93)	KBS61500	length outside diameter flange diameter flange depth	length 63.5 comp. height 32.2 -1.3	top 1.5 2nd 1.5 oil 4.0	
			pin = 20.0 x 62.0 circlip required	N-SWT20-060 R-30845 T-	
			B6Z2-11-SAO	B6Y0-11-SCO B6Y0-11-SCOA B6Y0-11-SDO B6Y0-11-SDOA B6Y0-11-SDX B6Y0-11-SDXA B6Y0-11-SIOA B6Y1-11-SCO	
			2012 NEW		

MAZDA

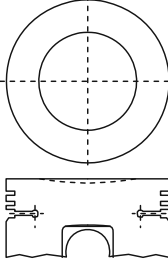
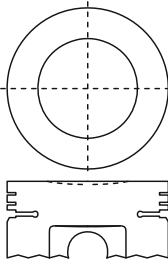
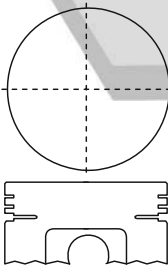
MOTOR - TYP	KOLBEN + RINGE PISTON + RINGS PISTONES + ANILLOS	LAUFBUCHSE CYL. SLEEVE CAMISAS	KOLBENSATZ PISTON SET PISTONES KIT	RINGSATZ RING SET ANILLOS	KOLBEN PISTON PISTONES
MAZDA VC Bore Dia. 80.0 mm 4 cyl. 1,769 cc 929 B1800 (73-86) SOHC 8V	KBS96700	LB96700 length 177.8 outside diameter 84.0 flange diameter flange depth 8173-23-206	KB96700 length 73.0 comp. height 36.0 -2.0 pin = 22.0 x 64.5 circlip required	KR96700 top 2.0 2nd 2.0 oil 4.0 N-SWT20-030 R-30320 T-33728 O453-23-130 O453-23-130B 3975-23-130	
			0453-23-200		
MAZDA VC New Bore Dia. 80.0 mm 4 cyl. 1,769 cc 929 B1800 (73-86) SOHC 8V	KBS96710	LB96710 length 177.8 outside diameter 84.0 flange diameter flange depth 8173-23-206	KB96710 length 73.0 comp. height 36.0 -2.0 pin = 20.0 x 65.0 circlip not required	KR96710 top 1.2 2nd 1.5 oil 4.0 N-SWT20-031 R-30200/ 30830 T-33737 4116-23-200 8171-23-200 H801-23-200 8682-23-130 8682-23-130A D97Z-6149 HE18-23-130	
			4116-23-200 8171-23-200 H801-23-200		
MAZDA MA New Bore Dia. 80.0 mm 4 cyl. 1,970 cc 929 B2000 (77-89) SOHC 8V	KBS96720	LB96720 length 177.8 outside diameter 84.0 flange diameter flange depth 8173-23-206	KB96720 length 73.5 comp. height 36.5 +0 pin = 20.0 x 65.0 circlip not required	KR96720 top 1.2 2nd 1.5 oil 4.0 N-SWT20-031 R-30200/ 30830 T-33737 4112-23-200 8682-23-200A HE01-23-200 8682-23-130 8682-23-130A D97Z-6149 HE18-23-130	
			4112-23-200 8682-23-200A HE01-23-200		

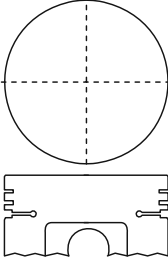
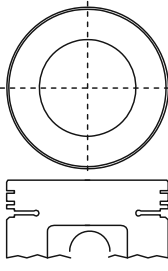
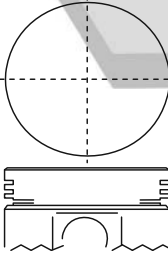

MOTOR - TYP	KOLBEN + RINGE PISTON + RINGS PISTONES + ANILLOS	LAUFBUCHSE CYL. SLEEVE CAMISAS	KOLBENSATZ PISTON SET PISTONES KIT	RINGSATZ RING SET ANILLOS	KOLBEN PISTON PISTONES
MAZDA MA-II Bore Dia. 80.0 mm 4 cyl. 1,970 cc 929 B2000 (77-89) SOHC 8V	KBS96730	LB96730 length 177.8 outside diameter 84.0 flange diameter flange depth 8173-23-206	length 73.5 comp. height 36.5 +0	top 1.5 2nd 2.0 oil 4.0	
			pin = 20.0 x 65.0 circlip not required	N-SWT20-042 R-30900 T-33745	
			HE41-23-200	HE05-23-130	
MAZDA VC Bore Dia. 80.0 mm 4 cyl. 1,769 cc 929 B1800 (73-86) SOHC 8V	KBS96740	LB96740 length 177.8 outside diameter 84.0 flange diameter flange depth 8173-23-206	length 73.0 comp. height 36.0 +0	top 1.5 2nd 2.0 oil 4.0	
			pin = 20.0 x 65.0 circlip not required	N-SWT20-042 R-30900 T-33745	
			H802-23-200	HE05-23-130	
MAZDA MA Bore Dia. 80.0 mm 4 cyl. 1,970 cc 626 B2000 (77-89) SOHC 8V	KBS96750	LB96750 length 177.8 outside diameter 84.0 flange diameter flange depth 8173-23-206	length 73.2 comp. height 36.2 +0	top 2.0 2nd 2.0 oil 4.0	
			pin = 22.0 x 64.5 circlip required	N-SWT20-030 R-30320 T-33728	
			3975-23-200	0453-23-130 0453-23-130B 3975-23-130	

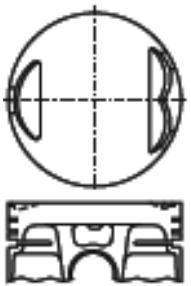
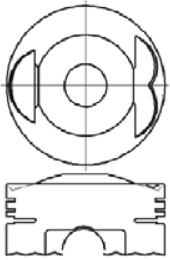
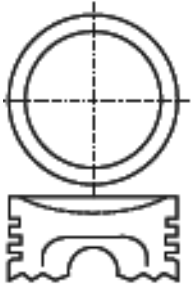

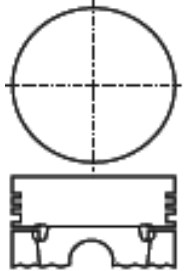
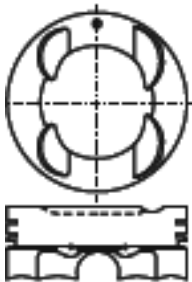
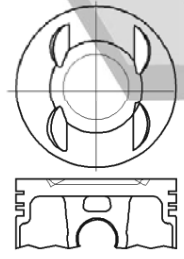
MOTOR - TYP	KOLBEN + RINGE PISTON + RINGS PISTONES + ANILLOS	LAUFBUCHSE CYL. SLEEVE CAMISAS	KOLBENSATZ PISTON SET PISTONES KIT	RINGSATZ RING SET ANILLOS	KOLBEN PISTON PISTONES
MAZDA F6 Bore Dia. 81.0 mm 4 cyl. 1,587 cc 626 CAPELLA (82-87) SOHC 8V	KBS96760	LB96760 length 150.0 outside diameter 85.0 flange diameter flange depth	KB96760 length 71.0 comp. height 34.0 +0	KR96760 top 1.5 2nd 1.5 oil 4.0	
			pin = 22.0 x 67.0 circlip not required F601-23-200	N-SWT20-054 R-30650/ 30655 T-33748 F601-23-130/A F601-23-131/A F601-23-132/A F601-23-133/A F601-23-134/A F6Y1-11-SCO F6Y1-11-SDO F6Y1-11-SDX F6Y1-11-SDY F6Y1-11-SDZ	
MAZDA F6 Bore Dia. 81.0 mm 4 cyl. 1,587 cc 626 B1600 (85-89) SOHC 8V	KBS96770	LB96770 length 150.0 outside diameter 85.0 flange diameter flange depth	KB96770 length 76.0 comp. height 34.2 +4.7	KR96770 top 1.5 2nd 1.5 oil 4.0	
			pin = 22.0 x 67.0 circlip not required F605-23-200 F605-23-210 F605-23-220 F605-23-230 F605-23-240	N-SWT20-054 R-30650/ 30655 T-33748 F601-23-130/A F601-23-131/A F601-23-132/A F601-23-133/A F601-23-134/A F6Y1-11-SCO F6Y1-11-SDO F6Y1-11-SDX F6Y1-11-SDY F6Y1-11-SDZ	
MAZDA VA Bore Dia. 82.0 mm 4 cyl. 1,985 cc TITAN F2000 (71-88) SOHC 8V	KBS96780	LB96780 length outside diameter flange diameter flange depth	KB96780 length 83.0 comp. height 44.5 -6.0	KR96780 top 2.5 2nd 2.5 oil 4.5	
			pin = 22.0 x 71.0 circlip required O164-11-102 O164-23-200	N-SCT20-012 R-30460 T- O164-11-999	

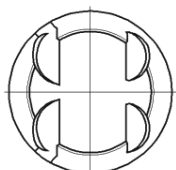
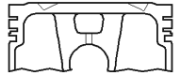
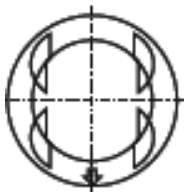

MOTOR - TYP	KOLBEN + RINGE PISTON + RINGS PISTONES + ANILLOS	LAUFBUCHSE CYL. SLEEVE CAMISAS	KOLBENSATZ PISTON SET PISTONES KIT	RINGSATZ RING SET ANILLOS	KOLBEN PISTON PISTONES
MAZDA VA Bore Dia. 82.0 mm 4 cyl. 1,985 cc TITAN G2000 (71-88) SOHC 8V	KBS96781	LB96781	KB96781	KR96781	
MAZDA BP Bore Dia. 83.0 mm 4 cyl. 1,839 cc 323 16V	KBS51000	LB51000	KB51000	KR51000	
MAZDA BP Bore Dia. 83.0 mm 4 cyl. 1,839 cc 323 (89-91) SOHC 16V	KBS51001	LB51001	KB51001	KR51001	

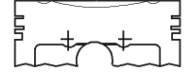

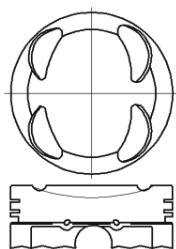
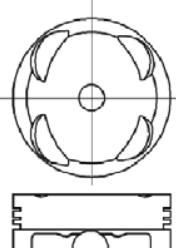
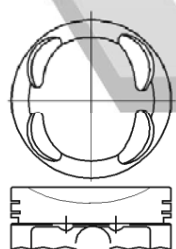
MOTOR - TYP	KOLBEN + RINGE PISTON + RINGS PISTONES + ANILLOS	LAUFBUCHSE CYL. SLEEVE CAMISAS	KOLBENSATZ PISTON SET PISTONES KIT	RINGSATZ RING SET ANILLOS	KOLBEN PISTON PISTONES
MAZDA BP Bore Dia. 83.0 mm 4 cyl. 1,839 cc 323 (89-96) DOHC 16V	KBS51002	LB51002 length outside diameter flange diameter flange depth	length 61.5 comp. height 30.6 +0.5	top 1.5 2nd 1.5 oil 3.0	 
			pin = 20.0 x 57.0 circlip required	N-SWT20-066 R-30043 / 30275 T-33769	
			BPY1-11-SAO BPY1-11-SAOA BPY1-11-SBO BPY1-11-SBOA BPY1-11-SBX BPY1-11-SBXA	BPY1-11-SCO BPY1-11-SDO BPY1-11-SDX BPY4-11-SCO BPY4-11-SDO BPZ0-11-SCOA BPZ0-11-SCOB BPZ0-11-SDOA BPZ0-11-SDOB BPZ0-11-SDXA/XB	
MAZDA BP Bore Dia. 83.0 mm 4 cyl. 1,839 cc 323 (89-91) DOHC 16V	KBS51003	LB51003 length outside diameter flange diameter flange depth	length 61.5 comp. height 31.2 -2.5	top 1.5 2nd 1.5 oil 3.0	 
			pin = 20.0 x 57.0 circlip required	N-SWT20-066 R-30043 / 30275 T-33769	
			BPY3-11-SAO BPY3-11-SBO BPY3-11-SBX	BPY1-11-SCO BPY1-11-SDO BPY1-11-SDX BPY4-11-SCO BPY4-11-SDO BPZ0-11-SCOA BPZ0-11-SCOB BPZ0-11-SDOA BPZ0-11-SDOB BPZ0-11-SDXA/XB	
MAZDA FP Bore Dia. 83.0 mm 4 cyl. 1,839 cc 626 MPV (91-01) DOHC 16V	KBS62500	LB62500 length outside diameter flange diameter flange depth	length 54.43 comp. height 30.43 -7.3	top 1.2 2nd 1.5 oil 3.0	 
			pin = 19.0 x 58.0 circlip not required	N-SWT20-078 R-30273 T-33761 / 33762	
			FPO1-11-102A	FSY1-11-SCO FSY1-11-SCOA FSY1-11-SDO FSY1-11-SDOA FSY1-11-SDX FSY1-11-SDXA FSY2-11-SCO FSY2-11-SCOA FSY2-11-SDO/OA FSY2-11-SDX/XA	

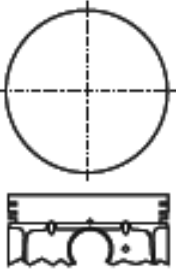
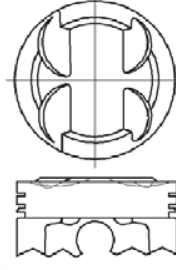
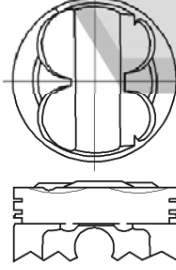
MOTOR - TYP	KOLBEN + RINGE PISTON + RINGS PISTONES + ANILLOS	LAUFBUCHSE CYL. SLEEVE CAMISAS	KOLBENSATZ PISTON SET PISTONES KIT	RINGSATZ RING SET ANILLOS	KOLBEN PISTON PISTONES
MAZDA FP Bore Dia. 83.0 mm 4 cyl. 1,839 cc 626 MPV (91-01) DOHC 16V	KBS62501	LB62501 length outside diameter flange diameter flange depth	length 53.9 comp. height 29.9 -6.0 pin = 19.0 x 58.0 circlip not required	top 1.2 2nd 1.5 oil 3.0 N-SWT20-078 R-30273 T-33761 / 33762	
			FPY1-11-SAOA FPY1-11-SAOB FPY1-11-SAOC FPY1-11-SAOE FPY1-11-SBOA FPY1-11-SBOB FPY1-11-SBOC FPY1-11-SBOE FPY1-11-SBXA/XB FPY1-11-SBXC/XE	FSY1-11-SCO FSY1-11-SCOA FSY1-11-SDO FSY1-11-SDOA FSY1-11-SDX FSY1-11-SDXA FSY2-11-SCO FSY2-11-SCOA FSY2-11-SDO/OA FSY2-11-SDX/XA	
MAZDA FS Bore Dia. 83.0 mm 4 cyl. 1,998 cc 626 MX-6 DOHC 16V	KBS15500	LB15500 length outside diameter flange diameter flange depth	length 54.43 comp. height 30.43 -9.6 pin = 19.0 x 58.0 circlip not required	top 1.2 2nd 1.5 oil 3.0 N-SWT20-078 R-30273 T-33761 / 33762	
			FSO1-11-102A	FSY1-11-SCO FSY1-11-SCOA FSY1-11-SDO FSY1-11-SDOA FSY1-11-SDX FSY1-11-SDXA FSY2-11-SCO FSY2-11-SCOA FSY2-11-SDO/OA FSY2-11-SDX/XA	
MAZDA FS Bore Dia. 83.0 mm 4 cyl. 1,998 cc 626 MX-6 (91) DOHC 16V	KBS15501	LB15501 length outside diameter flange diameter flange depth	length 53.9 comp. height 29.9 -8.3 pin = 19.0 x 58.0 circlip not required	top 1.2 2nd 1.5 oil 3.0 N-SWT20-078 R-30273 T-33761 / 33762	
			FSY1-11-SAO FSY1-11-SAOA FSY1-11-SAOB FSY1-11-SBOA FSY1-11-SBOB FSY1-11-SBXA FSY1-11-SBXC	FSY1-11-SCO FSY1-11-SCOA FSY1-11-SDO FSY1-11-SDOA FSY1-11-SDX FSY1-11-SDXA FSY2-11-SCO FSY2-11-SCOA FSY2-11-SDO/OA FSY2-11-SDX/XA	

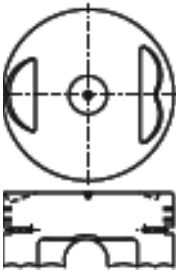
MOTOR - TYP	KOLBEN + RINGE PISTON + RINGS PISTONES + ANILLOS	LAUFBUCHSE CYL. SLEEVE CAMISAS	KOLBENSATZ PISTON SET PISTONES KIT	RINGSATZ RING SET ANILLOS	KOLBEN PISTON PISTONES			
MAZDA L8 Bore Dia. 83.0 mm 4 cyl. 1,798 cc 5 6 MX-5 (02-07) DOHC 16V	KBS56000 top and 2nd ring lands anodized skirt MOS2 treated	LB56000 length outside diameter flange diameter flange depth	KB56000 length 51.0 comp. height 28.5 +0 pin = 21.0 x 60.0 circlip not required L8Y1-11-010 L8Y1-11-SAO L8Y1-11-SAOA	KR56000 top 1.2 2nd 1.2 oil 2.5 N- R- T- L8Y1-11-SCA L8Y1-11-SCO L8Y1-11-SCOA				
			length 63.0 comp. height 30.7 +2.0 -3.9 pin = 20.0 x 57.0 circlip required BPZO-11-SAO BPZO-11-SBO BPZO-11-SBX	top 1.5 2nd 1.5 oil 3.0 N-SWT20-066 R-30043 / 30275 T-33769 BPY1-11-SCO BPY1-11-SDO BPY1-11-SDX BPY4-11-SCO BPY4-11-SDO BPZO-11-SCOA BPZO-11-SCOB BPZO-11-SDOA BPZO-11-SDOB BPZO-11-SDXA/XB				
			length 64.0 outside diameter flange diameter flange depth	length 64.0 comp. height 30.7 +3.0 -4.3 pin = 20.0 x 57.0 circlip required BPZ3-11-SAO BPZ3-11-SBO BPZ3-11-SBX			top 1.5 2nd 1.5 oil 3.0 N-SWT20-066 R-30043 / 30275 T-33769 BPY1-11-SCO BPY1-11-SDO BPY1-11-SDX BPY4-11-SCO BPY4-11-SDO BPZO-11-SCOA BPZO-11-SCOB BPZO-11-SDOA BPZO-11-SDOB BPZO-11-SDXA/XB	
			length 63.0 comp. height 30.7 +2.0 -3.9 pin = 20.0 x 57.0 circlip required BPZO-11-SAO BPZO-11-SBO BPZO-11-SBX	top 1.5 2nd 1.5 oil 3.0 N-SWT20-066 R-30043 / 30275 T-33769 BPY1-11-SCO BPY1-11-SDO BPY1-11-SDX BPY4-11-SCO BPY4-11-SDO BPZO-11-SCOA BPZO-11-SCOB BPZO-11-SDOA BPZO-11-SDOB BPZO-11-SDXA/XB				
length 64.0 outside diameter flange diameter flange depth	length 64.0 comp. height 30.7 +3.0 -4.3 pin = 20.0 x 57.0 circlip required BPZ3-11-SAO BPZ3-11-SBO BPZ3-11-SBX	top 1.5 2nd 1.5 oil 3.0 N-SWT20-066 R-30043 / 30275 T-33769 BPY1-11-SCO BPY1-11-SDO BPY1-11-SDX BPY4-11-SCO BPY4-11-SDO BPZO-11-SCOA BPZO-11-SCOB BPZO-11-SDOA BPZO-11-SDOB BPZO-11-SDXA/XB						
length 63.0 comp. height 30.7 +2.0 -3.9 pin = 20.0 x 57.0 circlip required BPZO-11-SAO BPZO-11-SBO BPZO-11-SBX	top 1.5 2nd 1.5 oil 3.0 N-SWT20-066 R-30043 / 30275 T-33769 BPY1-11-SCO BPY1-11-SDO BPY1-11-SDX BPY4-11-SCO BPY4-11-SDO BPZO-11-SCOA BPZO-11-SCOB BPZO-11-SDOA BPZO-11-SDOB BPZO-11-SDXA/XB							

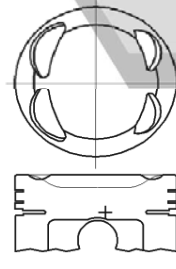

MOTOR - TYP	KOLBEN + RINGE PISTON + RINGS PISTONES + ANILLOS	LAUFBUCHSE CYL. SLEEVE CAMISAS	KOLBENSATZ PISTON SET PISTONES KIT	RINGSATZ RING SET ANILLOS	KOLBEN PISTON PISTONES
MAZDA F8 Bore Dia. 86.0 mm 4 cyl. 1,789 cc 626 B1800 (87-96) SOHC 8V	KBS63510	LB63510 length 158.8 outside diameter 90.0 flange diameter flange depth F801-10-311	KB63510 length 71.2 comp. height 34.2 +0 pin = 22.0 x 67.0 circlip not required	KR63510 top 1.5 2nd 1.5 oil 4.0 N-SWT20-048/065 R-30660 / 30661 30680 / 30682 T-33747	
			F801-11-102 F801-23-200 F801-23-200A F801-23-210 F801-23-210A F801-23-220 F801-23-220A	F2Y1-11-SCO F2Y1-11-SDO F2Y1-11-SDX F2Y2-11-SCO F801-23-130 F801-23-130A F801-23-131A F801-23-132A F8Y1-11-SCO F8Y1-11-SDO/DX	
MAZDA FE Bore Dia. 86.0 mm 4 cyl. 1,998 cc 626 W/O EGI (85-99) SOHC 8V	KBS63520	LB63520 length 180.0 outside diameter 90.0 flange diameter flange depth	KB63520 length 71.1 comp. height 34.1 -2.7 pin = 22.0 x 67.0 circlip not required	KR63520 top 1.5 2nd 1.5 oil 4.0 N-SWT20-048/065 R-30660 / 30661 30680 / 30682 T-33747	
			FE01-11-102 FE01-23-200 FE01-23-210 FE01-23-220	F2Y1-11-SCO F2Y1-11-SDO F2Y1-11-SDX F2Y2-11-SCO F801-23-130 F801-23-130A F801-23-131A F801-23-132A F8Y1-11-SCO F8Y1-11-SDO/DX	
MAZDA F2 Bore Dia. 86.0 mm 4 cyl. 2,184 cc 626 929 (87-96) SOHC 12V	KBS63530	LB63530 length 158.8 outside diameter 90.0 flange diameter flange depth F801-10-311	KB63530 length 71.4 comp. height 36.5 -6.8 pin = 22.0 x 67.0 circlip not required	KR63530 top 1.5 2nd 1.5 oil 4.0 N-SWT20-048/065 R-30660 / 30661 30680 / 30682 T-33747	
			F2Y1-11-SAO F2Y2-11-SAOA F2Y2-11-SBO F2Y2-11-SBX	F2Y1-11-SCO F2Y1-11-SDO F2Y1-11-SDX F2Y2-11-SCO F801-23-130 F801-23-130A F801-23-131A F801-23-132A F8Y1-11-SCO F8Y1-11-SDO/DX	

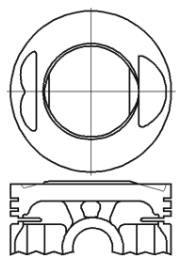
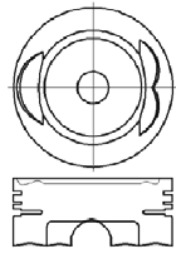
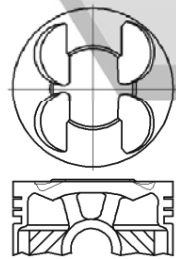

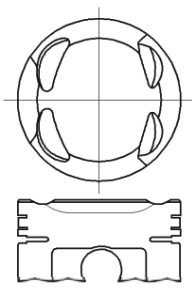
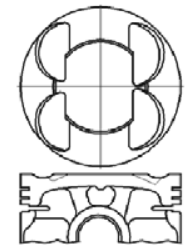
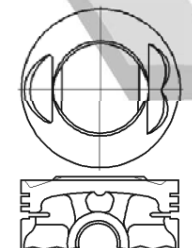
MOTOR - TYP	KOLBEN + RINGE PISTON + RINGS PISTONES + ANILLOS	LAUFBUCHSE CYL. SLEEVE CAMISAS	KOLBENSATZ PISTON SET PISTONES KIT	RINGSATZ RING SET ANILLOS	KOLBEN PISTON PISTONES
MAZDA FE Bore Dia. 86.0 mm 4 cyl. 1,998 cc 626 SOHC 8V	KBS63540	LB63540 length 180.0 outside diameter 90.0 flange diameter flange depth	KB63540 length 72.2 comp. height 34.0 +1.7 pin = 22.0 x 67.0 circlip not required	KR63540 top 1.5 2nd 1.5 oil 4.0 N-SWT20-048/065 R-30660 / 30661 30680 / 30682 T-33747 F2Y1-11-SCO F2Y1-11-SDO F2Y1-11-SDX F2Y2-11-SCO F801-23-130 F801-23-130A F801-23-131A F801-23-132A F8Y1-11-SCO F8Y1-11-SDO/DX	
MAZDA FE Bore Dia. 86.0 mm 4 cyl. 1,998 cc 626 SOHC 8V	KBS63541	LB63541 length 180.0 outside diameter 90.0 flange diameter flange depth	KB63541 length 71.1 comp. height 34.1 -2.7 pin = 22.0 x 67.0 circlip not required	KR63541 top 1.5 2nd 1.5 oil 4.0 N-SWT20-048/065 R-30660 / 30661 30680 / 30682 T-33747 F2Y1-11-SCO F2Y1-11-SDO F2Y1-11-SDX F2Y2-11-SCO F801-23-130 F801-23-130A F801-23-131A F801-23-132A F8Y1-11-SCO F8Y1-11-SDO/DX	
MAZDA FE Bore Dia. 86.0 mm 4 cyl. 1,998 cc 626 (88-92) DOHC 16V	KBS63542	LB63542 length 180.0 outside diameter 90.0 flange diameter flange depth	KB63542 length 72.5 comp. height 36.5 +1.0 pin = 22.0 x 71.5 circlip required FEYB-11-SAOA FEYB-11-SAOB FEYB-11-SBOA FEYB-11-SBOB FEYB-11-SBXA FEYB-11-SBXB	KR63542 top 1.5 2nd 1.5 oil 4.0 N-SWT20-048/065 R-30660 / 30661 30680 / 30682 T-33747 F2Y1-11-SCO F2Y1-11-SDO F2Y1-11-SDX F2Y2-11-SCO F801-23-130 F801-23-130A F801-23-131A F801-23-132A F8Y1-11-SCO F8Y1-11-SDO/DX	

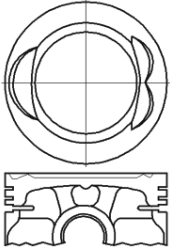
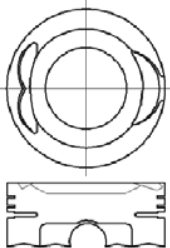
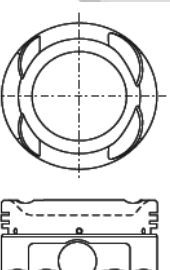
MOTOR - TYP	KOLBEN + RINGE PISTON + RINGS PISTONES + ANILLOS	LAUFBUCHSE CYL. SLEEVE CAMISAS	KOLBENSATZ PISTON SET PISTONES KIT	RINGSATZ RING SET ANILLOS	KOLBEN PISTON PISTONES
MAZDA F2 Bore Dia. 86.0 mm 4 cyl. 2,184 cc 626 929 SOHC 16V	KBS63550	LB63550 length 158.8 outside diameter 90.0 flange diameter flange depth F801-10-311	KB63550 length 71.4 comp. height 36.5 -6.6 pin = 22.0 x 67.0 circlip not required	KR63550 top 1.5 2nd 1.5 oil 4.0 N-SWT20-048/065 R-30660 / 30661 30680 / 30682 T-33747	
			F2Y1-11-SCO F2Y1-11-SDO F2Y1-11-SDX F2Y2-11-SCO F801-23-130 F801-23-130A F801-23-131A F801-23-132A F8Y1-11-SCO F8Y1-11-SDO/DX		
MAZDA FE Bore Dia. 86.0 mm 4 cyl. 1,998 cc 626 (87-89) SOHC 12V	KBS63543	LB63543 length 180.0 outside diameter 90.0 flange diameter flange depth	KB63543 length 71.1 comp. height 34.6 -5.5 pin = 22.0 x 67.0 circlip not required	KR63543 top 1.5 2nd 1.5 oil 4.0 N-SWT20-048/065 R-30660 / 30661 30680 / 30682 T-33747	
			FEYC-11-SAO FEYC-11-SAOA FEYC-11-SBO FEYC-11-SBX	F2Y1-11-SCO F2Y1-11-SDO F2Y1-11-SDX F2Y2-11-SCO F801-23-130 F801-23-130A F801-23-131A F801-23-132A F8Y1-11-SCO F8Y1-11-SDO/DX	
MAZDA FE Bore Dia. 86.0 mm 4 cyl. 1,998 cc 626 EGI 929 (85-89) SOHC 8V	KBS63544	LB63544 length 180.0 outside diameter 90.0 flange diameter flange depth	KB63544 length 72.8 comp. height 34.0 +1.8 pin = 22.0 x 67.0 circlip not required	KR63544 top 1.5 2nd 1.5 oil 4.0 N-SWT20-048/065 R-30660 / 30661 30680 / 30682 T-33747	
			FEA7-23-200 FEA7-23-210 FEA7-23-220	F2Y1-11-SCO F2Y1-11-SDO F2Y1-11-SDX F2Y2-11-SCO F801-23-130 F801-23-130A F801-23-131A F801-23-132A F8Y1-11-SCO F8Y1-11-SDO/DX	

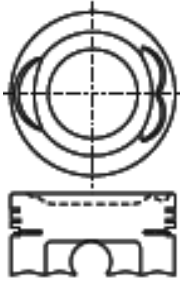
MOTOR - TYP	KOLBEN + RINGE PISTON + RINGS PISTONES + ANILLOS	LAUFBUCHSE CYL. SLEEVE CAMISAS	KOLBENSATZ PISTON SET PISTONES KIT	RINGSATZ RING SET ANILLOS	KOLBEN PISTON PISTONES
MAZDA FE Bore Dia. 86.0 mm 4 cyl. 1,998 cc 626 EGI (85) SOHC 8V	KBS63545	LB63545 length 180.0 outside diameter 90.0 flange diameter flange depth	KB63545 length 71.0 comp. height 34.0 -2.5 pin = 22.0 x 67.0 circlip not required FEY3-11-SAO FEY3-11-SBO FEY3-11-SBX	KR63545 top 1.5 2nd 1.5 oil 4.0 N-SWT20-048/065 R-30660 / 30661 30680 / 30682 T-33747	
			FEY3-11-SAO FEY3-11-SBO FEY3-11-SBX	F2Y1-11-SCO F2Y1-11-SDO F2Y1-11-SDX F2Y2-11-SCO F801-23-130 F801-23-130A F801-23-131A F801-23-132A F8Y1-11-SCO F8Y1-11-SDO/DX	
MAZDA FET Bore Dia. 86.0 mm 4 cyl. 1,998 cc 626 929 (86-87) SOHC 8V	KBS63560	LB63560 length 180.0 outside diameter 90.0 flange diameter flange depth	KB63560 length 71.0 comp. height 34.0 -6.0 pin = 22.0 x 67.0 circlip not required FE30-23-200A	KR63560 top 1.5 2nd 1.5 oil 4.0 N-SWT20-048/065 R-30660 / 30661 30680 / 30682 T-33747	
			FE30-23-200A	F2Y1-11-SCO F2Y1-11-SDO F2Y1-11-SDX F2Y2-11-SCO F801-23-130 F801-23-130A F801-23-131A F801-23-132A F8Y1-11-SCO F8Y1-11-SDO/DX	
MAZDA F2T Bore Dia. 86.0 mm 4 cyl. 2,184 cc 626 MX-6 SOHC 16V	KBS63560	LB63560 length 158.8 outside diameter 90.0 flange diameter flange depth F801-10-311	KB63560 length 71.5 comp. height 36.5 -3.7 -9.5 pin = 22.0 x 67.0 circlip not required F220-11-SAO	KR63560 top 1.5 2nd 1.5 oil 4.0 N-SWT20-048/065 R-30660 / 30661 30680 / 30682 T-33747	
			F220-11-SAO	F2Y1-11-SCO F2Y1-11-SDO F2Y1-11-SDX F2Y2-11-SCO F801-23-130 F801-23-130A F801-23-131A F801-23-132A F8Y1-11-SCO F8Y1-11-SDO/DX	

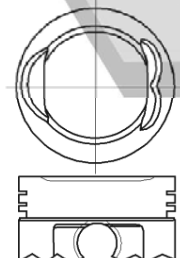
MOTOR - TYP	KOLBEN + RINGE PISTON + RINGS PISTONES + ANILLOS	LAUFBUCHSE CYL. SLEEVE CAMISAS	KOLBENSATZ PISTON SET PISTONES KIT	RINGSATZ RING SET ANILLOS	KOLBEN PISTON PISTONES
MAZDA F2 Bore Dia. 86.0 mm 4 cyl. 2,184 cc B2200 EGI (94-99) SOHC 8V	KBS63551	LB63551 length 158.8 outside diameter 90.0 flange diameter flange depth F801-10-311	KB63551 length 70.9 comp. height 36.1 -5.4 pin = 22.0 x 67.0 circlip not required	KR63551 top 1.5 2nd 1.5 oil 4.0 N-SWT20-048/065 R-30660 / 30661 30680 / 30682 T-33747	
			F2Y4-11-SAO F2Y4-11-SAOA F2Y4-11-SBO F2Y4-11-SBX	F2Y1-11-SCO F2Y1-11-SDO F2Y1-11-SDX F2Y2-11-SCO F801-23-130 F801-23-130A F801-23-131A F801-23-132A F8Y1-11-SCO F8Y1-11-SDO/DX	
MAZDA FE Bore Dia. 86.0 mm 4 cyl. 1,998 cc 626 (87-89) DOHC 16V	KBS63546	LB63546 length 180.0 outside diameter 90.0 flange diameter flange depth	KB63546 length 71.5 comp. height 36.5 -1.6 pin = 22.0 x 72.0 circlip not required	KR63546 top 1.5 2nd 1.5 oil 4.0 N-SWT20-048/065 R-30660 / 30661 30680 / 30682 T-33747	
			FEYA-11-SAO FEYA-11-SAOB FEYA-11-SBOB FEYA-11-SBxB	F2Y1-11-SCO F2Y1-11-SDO F2Y1-11-SDX F2Y2-11-SCO F801-23-130 F801-23-130A F801-23-131A F801-23-132A F8Y1-11-SCO F8Y1-11-SDO/DX	
MAZDA F2 Bore Dia. 86.0 mm 4 cyl. 2,184 cc 626 (88-92) SOHC 12V	KBS63552	LB63552 length 158.8 outside diameter 90.0 flange diameter flange depth F801-10-311	KB63552 length 71.4 comp. height 36.4 -1.2 -3.0 pin = 22.0 x 67.0 circlip not required	KR63552 top 1.5 2nd 1.5 oil 4.0 N-SWT20-048/065 R-30660 / 30661 30680 / 30682 T-33747	
			F2Y1-11-SCO F2Y1-11-SDO F2Y1-11-SDX F2Y2-11-SCO F801-23-130 F801-23-130A F801-23-131A F801-23-132A F8Y1-11-SCO F8Y1-11-SDO/DX		

MAZDA

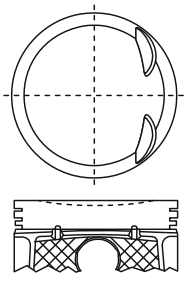
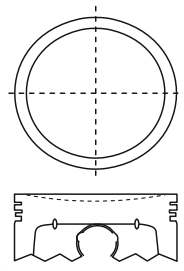
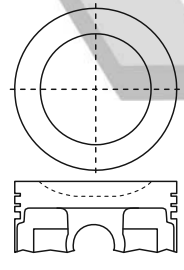
MOTOR - TYP	KOLBEN + RINGE PISTON + RINGS PISTONES + ANILLOS	LAUFBUCHSE CYL. SLEEVE CAMISAS	KOLBENSATZ PISTON SET PISTONES KIT	RINGSATZ RING SET ANILLOS	KOLBEN PISTON PISTONES
MAZDA L3 Bore Dia. 87.5 mm 4 cyl. 2,261 cc 3 6 (02) DOHC 16V	KBS20000 top and 2nd ring lands anodized skirt MOS2 treated	LB20000 length outside diameter flange diameter flange depth	KB20000 length 51.0 comp. height 28.5 -2.2 -3.3 pin = 21.0 x 60.0 circlip not required L3Y2-11-010 L3Y2-11-SAO L3Y2-11-SAOA	KR20000 top 1.2 2nd 1.2 oil 2.5 N- R-30155 T- L3Y1-11-SCA L3Y1-11-SCO L3Y1-11-SCOA L3Y3-11-SCO LFY1-11-SCA LFY1-11-SCO LFY1-11-SCOA LFY5-11-SCO	
			pin = 21.0 x 60.0 circlip not required LFY1-11-010 LFY1-11-SAO LFY1-11-SAOA	N- R-30155 T- L3Y1-11-SCA L3Y1-11-SCO L3Y1-11-SCOA L3Y3-11-SCO LFY1-11-SCA LFY1-11-SCO LFY1-11-SCOA LFY5-11-SCO	
MAZDA LF Bore Dia. 87.5 mm 4 cyl. 1,999 cc 3 5 6 (02-06) DOHC 16V	KBS21000 top and 2nd ring lands anodized skirt MOS2 treated	LB21000 length outside diameter flange diameter flange depth	KB21000 length 51.0 comp. height 28.5 -0.35	KR21000 top 1.2 2nd 1.2 oil 2.5 N- R-30155 T- LFY1-11-010 LFY1-11-SAO LFY1-11-SAOA	
			pin = 21.0 x 60.0 circlip not required LFY1-11-010 LFY1-11-SAO LFY1-11-SAOA	N- R-30155 T- L3Y1-11-SCA L3Y1-11-SCO L3Y1-11-SCOA L3Y3-11-SCO LFY1-11-SCA LFY1-11-SCO LFY1-11-SCOA LFY5-11-SCO	
MAZDA G6 Bore Dia. 92.0 mm 4 cyl. 2,606 cc B2600 EGI (89-99) SOHC 12V	KBS63570	LB63570 length outside diameter flange diameter flange depth	KB63570 length 74.5 comp. height 36.5 -9.5 pin = 23.0 x 63.0 circlip not required G601-11-SAO G601-11-SAOB G601-11-SBOB G601-11-SBXB G602-11-SAO G602-11-SBO G602-11-SBX	KR63570 top 1.5 2nd 1.5 oil 4.0 N-SWT20-064 R-30180 T-33748 G601-11-SCOA G612-11-SCO G612-11-SDO G612-11-SDX	
			pin = 23.0 x 63.0 circlip not required G601-11-SAO G601-11-SAOB G601-11-SBOB G601-11-SBXB G602-11-SAO G602-11-SBO G602-11-SBX	N-SWT20-064 R-30180 T-33748 G601-11-SCOA G612-11-SCO G612-11-SDO G612-11-SDX	

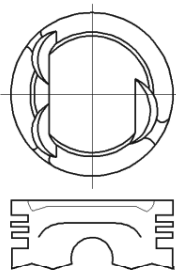
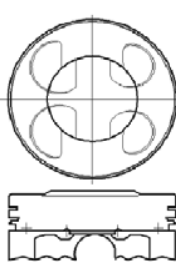
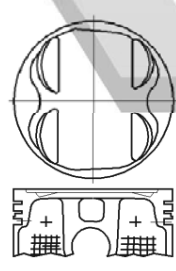
MOTOR - TYP	KOLBEN + RINGE PISTON + RINGS PISTONES + ANILLOS	LAUFBUCHSE CYL. SLEEVE CAMISAS	KOLBENSATZ PISTON SET PISTONES KIT	RINGSATZ RING SET ANILLOS	KOLBEN PISTON PISTONES
MAZDA JF Bore Dia. 74.0 mm 6 cyl. 1,997 cc 929 LUCE (86-89) SOHC 12V	KBS63580	LB63580 length outside diameter flange diameter flange depth	length 62.5 comp. height 32.5 -1.0	top 1.5 2nd 1.5 oil 4.0	
			pin = 20.0 x 61.0 circlip not required	N-SWT20-079 R-30610 T-	
			JFY3-11-SAO	JFY1-11-SCO	
MAZDA KF (L/R) Bore Dia. 78.0 mm 6 cyl. 1,995 cc 323F ZXI MX-6 XEDOS 6/9 (91-02) DOHC 24V	KBS64500	LB64500 length outside diameter flange diameter flange depth	length 57.5 comp. height 28.7 +1.5	top 1.5 2nd 1.5 oil 3.0	
			pin = 19.0 x 59.0 circlip not required	N- R- T-	
			KFY1-11-SAO	KYF2-11-SCOA KYF2-11-SDOA KYF2-11-SDXA	
MAZDA KL (L/R) Bore Dia. 84.5 mm 6 cyl. 2,497 cc MX-6 XEDOS 9 (91-96) DOHC 24V	KBS65500	LB65500 length outside diameter flange diameter flange depth	length 56.0 comp. height 29.2 -1.6	top 1.5 2nd 1.5 oil 3.0	
			pin = 20.0 x 61.0 circlip not required	N-SWT20-073 R-30982 T-33768	
			KLY1-11-SAO KLY1-11-SAOA KLY1-11-SBO (R) KLY1-11-SBOA KLY1-11-SBX/XA KLY1-11-SLO KLY1-11-SLOA KLY1-11-SMO (L) KLY1-11-SMOA KLY1-11-SMX/XA	KLY1-11-SCO KLY1-11-SCOA KLY1-11-SDO KLY1-11-SDOA KLY1-11-SDX KLY1-11-SDXA KLY2-11-SCO KLY2-11-SCOA KLY2-11-SDO/OA KLY2-11-SDX/XA	

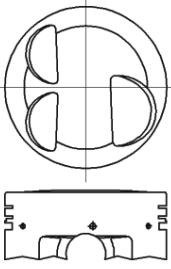
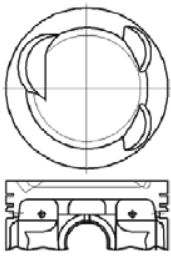
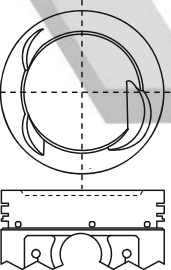
MOTOR - TYP	KOLBEN + RINGE PISTON + RINGS PISTONES ANILLOS	LAUFBUCHSE CYL. SLEEVE CAMISAS	KOLBENSAT PISTON SET PISTONES KIT	RINGSATZ RING SET ANILLOS	KOLBEN PISTON PISTONES
MAZDA JE Bore Dia. 90.0 mm 6 cyl. 2,954 cc MPV	KBS63590	LB63590	KB63590	KR63590	
		length outside diameter flange diameter flange depth	length 74.0 comp. height 35.5 +0 pin = 23.0 x 77.0 circlip not required JEY1-11-SAO	top 1.5 2nd 1.5 oil 4.0 N-SWT20-062 R-30240 T- JEYO-11-SCO JEYO-11-SDO JEYO-11-SDX JEY1-11-SCO JEY1-11-SDO JEY1-11-SDX	
MAZDA JE-ZE Bore Dia. 90.0 mm 6 cyl. 2,954 cc MPV (89-) DOHC 18V	KBS63600	LB63600	KB63600	KR63600	
	skirt MOS2 treated	length outside diameter flange diameter flange depth	length 74.0 comp. height 35.5 -3.6 pin = 23.0 x 77.0 circlip not required JEY6-11-SAO JEY6-11-SAOA JEY6-11-SAOB JEY6-11-SBOA JEY6-11-SBOB JEY6-11-SBXA JEY6-11-SBxB	top 1.5 2nd 1.5 oil 4.0 N-SWT20-062 R-30240 T- JEYO-11-SCO JEYO-11-SDO JEYO-11-SDX JEY1-11-SCO JEY1-11-SDO JEY1-11-SDX	
MAZDA JE-ZE (L/R) Bore Dia. 90.0 mm 6 cyl. 2,954 cc 929 (91) DOHC 24V	KBS63610	LB63610	KB63610	KR63610	
	skirt MOS2 treated	length outside diameter flange diameter flange depth	length 70.8 comp. height 35.1 -2.8 pin = 23.0 x 63.0 circlip required JEY8-11-SAX/XA/XA JEY8-11-SAY/YA/YB JEY8-11-SAZ/ZA/ZB (R) JEY8-11-SBO/OA/OB JEY8-11-SBX/XA/XB JEY8-11-SLX/XA JEY8-11-SLY/YA JEY8-11-SLZ/ZA JEY8-11-SMO/OA JEY8-11-SMX/XA	top 1.5 2nd 1.5 oil 4.0 N-SWT20-062 R-30240 T- JEYO-11-SCO JEYO-11-SDO JEYO-11-SDX JEY1-11-SCO JEY1-11-SDO JEY1-11-SDX	

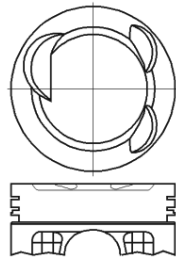

MOTOR - TYP	KOLBEN + RINGE PISTON + RINGS PISTONES + ANILLOS	LAUFBUCHSE CYL. SLEEVE CAMISAS	KOLBENSATZ PISTON SET PISTONES KIT	RINGSATZ RING SET ANILLOS	KOLBEN PISTON PISTONES				
MAZDA JE-ZE Bore Dia. 90.0 mm 6 cyl. 2,954 cc MPV (95-) DOHC 24V	KBS63601	LB63601	KB63601	KR63601					
						skirt MOS2 treated	length	length 71.1	top 1.5
							outside diameter	comp. height 35.5 -3.6 -6.7	2nd 1.5
							flange diameter	pin = 23.0 x 63.0 circlip not required	oil 4.0
flange depth	N-SWT20-062 R-30240 T- JEY7-11-SAX/XA JEY7-11-SAY/YA JEY7-11-SAZ/ZA (R) JEY7-11-SBO/OA JEY7-11-SBX/XA JEY7-11-SLX/XA JEY7-11-SLY/YA JEY7-11-SLZ/ZA (L) JEY7-11-SMO/OA JEY7-11-SMX/XA	JEYO-11-SCO JEYO-11-SDO JEYO-11-SDX JEY1-11-SCO JEY1-11-SDO JEY1-11-SDX							
	length	length	top						
	outside diameter	comp. height	2nd						
	flange diameter	pin = x	oil						
	flange depth		N- R- T-						
	length	length	top						
	outside diameter	comp. height	2nd						
	flange diameter	pin = x	oil						
	flange depth		N- R- T-						

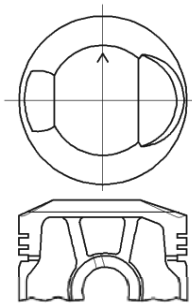
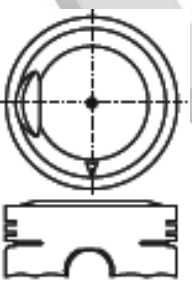

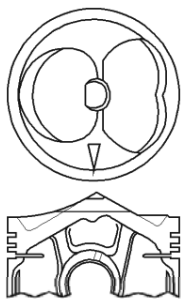
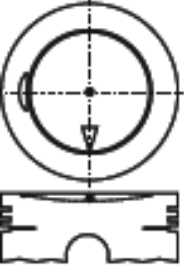
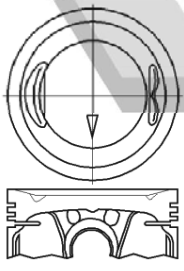
MOTOR - TYP	KOLBEN + RINGE PISTON + RINGS PISTONES + ANILLOS	LAUFBUCHSE CYL. SLEEVE CAMISAS	KOLBENSATZ PISTON SET PISTONES KIT	RINGSATZ RING SET ANILLOS	KOLBEN PISTON PISTONES
MITSUBISHI 2G21 Bore Dia. 62.0 mm 2 cyl. 359 cc MINICA F4 SKIPPER GT OHC 4V	KBS63620	LB63620 length outside diameter flange diameter flange depth	KB63620 length 65.5 comp. height 37.0 +6.4 pin = 17.0 x 54.0 circlip not required MDO16670	KR63620 top 1.5 2nd 1.5 oil 2.5 N-SWM30-073 R-20290 T-33844 MDO16760 MDO16765	
			length 65.5 comp. height 37.0 +6.4 pin = 17.0 x 54.0 circlip not required MDO16670	KR63620 top 1.5 2nd 1.5 oil 2.5 N-SWM30-073 R-20290 T-33844 MDO16760 MDO16765	
			length 65.5 comp. height 37.0 +6.4 pin = 17.0 x 54.0 circlip not required MDO16670	KR63620 top 1.5 2nd 1.5 oil 2.5 N-SWM30-073 R-20290 T-33844 MDO16760 MDO16765	
MITSUBISHI 2G22 Bore Dia. 65.0 mm 2 cyl. 471 cc MINICA MINICAB 5 (76) SOHC 4V	KBS63630	LB63630 length outside diameter flange diameter flange depth	KB63630 length comp. height pin = x	KR63630 top 1.5 2nd 1.5 oil 2.5 N-SWM31-131 R-20980 T-33847 MDO19470	
			length comp. height pin = x	KR63630 top 1.5 2nd 1.5 oil 2.5 N-SWM31-131 R-20980 T-33847 MDO19470	
			length comp. height pin = x	KR63630 top 1.5 2nd 1.5 oil 2.5 N-SWM31-131 R-20980 T-33847 MDO19470	
MITSUBISHI 2G23 Bore Dia. 70.0 mm 2 cyl. 546 cc L100 MINICAB WIDE 25 MINICAB AMI 55 (77-80) SOHC 4V	KBS63640	LB63640 length outside diameter flange diameter flange depth	KB63640 length 59.0 comp. height 27.0 +2.0 pin = 18.0 x 60.0 circlip not required MDO19851 MDO19861	KR63640 top 1.5 2nd 1.5 oil 2.5 N-SWM31-009 R-20060/ 20380 T-33855/ 33894 MDO11965 MDO19610	
			length 59.0 comp. height 27.0 +2.0 pin = 18.0 x 60.0 circlip not required MDO19851 MDO19861	KR63640 top 1.5 2nd 1.5 oil 2.5 N-SWM31-009 R-20060/ 20380 T-33855/ 33894 MDO11965 MDO19610	
			length 59.0 comp. height 27.0 +2.0 pin = 18.0 x 60.0 circlip not required MDO19851 MDO19861	KR63640 top 1.5 2nd 1.5 oil 2.5 N-SWM31-009 R-20060/ 20380 T-33855/ 33894 MDO11965 MDO19610	

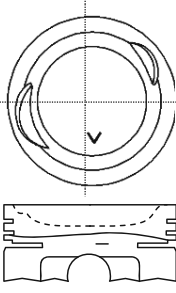

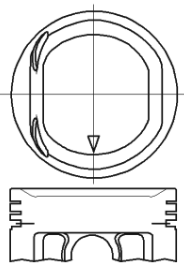
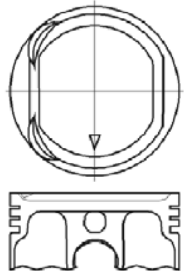
MOTOR - TYP	KOLBEN + RINGE PISTON + RINGS PISTONES + ANILLOS	LAUFBUCHSE CYL. SLEEVE CAMISAS	KOLBENSATZ PISTON SET PISTONES KIT	RINGSATZ RING SET ANILLOS	KOLBEN PISTON PISTONES
MITSUBISHI 2G23 Bore Dia. 70.0 mm 2 cyl. 546 cc L100 MINICAB WIDE 25 MINICA AMI 55 (77-80) OHC 4V	KBS63641	LB63641 length outside diameter flange diameter flange depth	length 67.5 comp. height 27.3 +10.2	top 1.5 2nd 1.5 oil 2.5	
			pin = 18.0 x 60.0 circlip not required	N-SWM31-009 R-20060/ 20380 T-33855/ 33894	
			MDO73733	MDO11965 MDO19610	
MITSUBISHI 2G24 Bore Dia. 76.0 mm 2 cyl. 644 cc MINICAB 700 (84) SOHC 4V	KBS63650	LB63650 length outside diameter flange diameter flange depth	length 57.0 comp. height 27.0 -0.4	top 1.5 2nd 1.5 oil 2.5	
			pin = 18.0 x 60.0 circlip not required	N-SWM31-064 R-20640 T-33882	
			MDO18240 MDO18241 MDO18242 MDO18248	MDO18280	
MITSUBISHI 2G25 Bore Dia. 78.0 mm 2 cyl. 783 cc MINICA 800 SOHC 6V	KBS63660	LB63660 length outside diameter flange diameter flange depth	length 57.5 comp. height 27.5 -2.3	top 1.5 2nd 1.5 oil 2.5	
			pin = 18.0 x 60.0 circlip not required	N-SWM31-066 R-20650 T-33891	
			MDO66511	MDO11810 MDO83152	

MOTOR - TYP	KOLBEN + RINGE PISTON + RINGS PISTONES + ANILLOS	LAUFBUCHSE CYL. SLEEVE CAMISAS	KOLBENSATZ PISTON SET PISTONES KIT	RINGSATZ RING SET ANILLOS	KOLBEN PISTON PISTONES
mitsubishi 3G82 Bore Dia. 65.0 mm 3 cyl. 657 cc MINICA SOHC 6V	KBS63670	LB63670 length outside diameter flange diameter flange depth	KB63670 length 52.0 comp. height 27.0 -8.0 pin = 16.0 x 51.0 circlip not required	KR63670 top 1.5 2nd 1.5 oil 2.8 N-SWM31-067 R-20003 T-33896 MD120289 MD120290 MD120291 MD120081	
			MD120289 MD120290 MD120291	MD120081	
mitsubishi 3G83 Bore Dia. 65.0 mm 3 cyl. 657 cc MINICA SOHC 6V	KBS63680	LB63680 length outside diameter flange diameter flange depth	KB63680 length 52.1 comp. height 26.1 +1.1 -4.0 pin = 16.0 x 51.0 circlip not required	KR63680 top 1.2 2nd 1.2 oil 2.8 N-SWM31-144 R-20892 T- MD120262 MD160195 MD160199	
			MD120262	MD160195 MD160199	
mitsubishi 3A91 Bore Dia. 75.0 mm 3 cyl. 1,124 cc COLT Z31A Z32A (04-) DOHC 12V	KBS50500	LB50500 length outside diameter flange diameter flange depth	KB50500 length comp. height pin = x circlip not required	KR50500 top 1.2 2nd 1.0 oil 2.0 N- R- T- MN195611 MN195612	
			MN195611	MN195612	

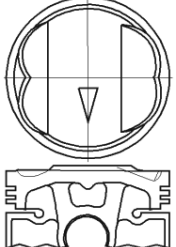
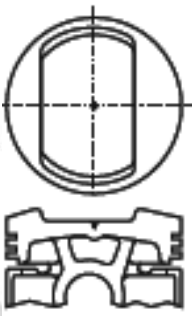
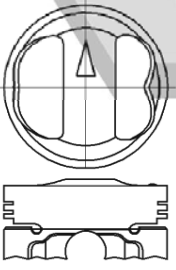
MOTOR - TYP	KOLBEN + RINGE PISTON + RINGS PISTONES + ANILLOS	LAUFBUCHSE CYL. SLEEVE CAMISAS	KOLBENSATZ PISTON SET PISTONES KIT	RINGSATZ RING SET ANILLOS	KOLBEN PISTON PISTONES
MITSUBISHI 4A31 Bore Dia. 66.0 mm 4 cyl. 1,094 cc MINICA SOHC 8V	KBS63690	LB63690 length outside diameter flange diameter flange depth	length 48.6 comp. height 26.6 -3.1	top 1.0 2nd 1.2 oil 2.5	
			pin = 16.0 x 46.0 circlip not required	N-SWM31-136 R- T-	
			MD333030 MD333031 MD333032 MD333033		
MITSUBISHI CM99 Bore Dia. 66.0 mm 4 cyl. 1,094 cc SOHC 8V	KBS63700	LB63700 length outside diameter flange diameter flange depth	length 48.65 comp. height 26.65 -3.09	top 1.0 2nd 1.2 oil 2.5	
			pin = 16.0 x 44.0 circlip not required	N-SWM31-136 R- T-	
			MD326541		
MITSUBISHI 4G16-EC Bore Dia. 68.2 mm 4 cyl. 1,198 cc COLT LANCER (83-89) SOHC 8V	KBS63710	LB63710 length outside diameter flange diameter flange depth	length 60.0 comp. height 29.0 +2.0	top 1.5 2nd 1.5 oil 4.0	
			pin = 18.0 x 60.0 circlip not required	N-SWM31-061 R- T-33857	
			MDO30343	MDO30360 MDO31730 MD115495	

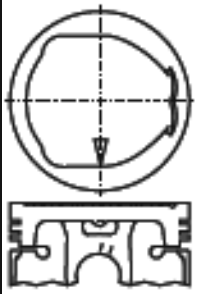
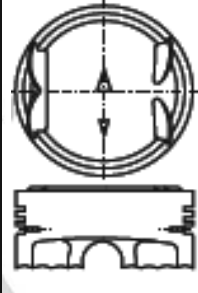
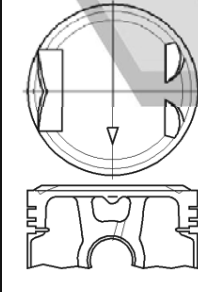
MOTOR - TYP	KOLBEN + RINGE PISTON + RINGS PISTONES + ANILLOS	LAUFBUCHSE CYL. SLEEVE CAMISAS	KOLBENSATZ PISTON SET PISTONES KIT	RINGSATZ RING SET ANILLOS	KOLBEN PISTON PISTONES	
mitsubishi 4G11 G11B Bore Dia. 69.5 mm 4 cyl. 1,244 cc COLT LANCER (79-84) SOHC 8V	KBS63720	LB63720 length 140.0 outside diameter 73.9 flange diameter flange depth MDO30698	KB63720 length 58.8 comp. height 29.0 +0.8 pin = 18.0 x 60.0 circlip not required MDO30312	KR63720 top 1.5 2nd 1.5 oil 4.0 N-SWM31-026 R-20050 T-33858 MDO30350 MDO31670		
			length 74.0 comp. height 31.7 +3.8 pin = 19.0 x 62.0 circlip required MDO10690 MDO11945 MDO11946	top 2.0 2nd 2.0 oil 4.0 N-SWM31-012 R-20080 T-33841 MDO10755 MDO10850		
			length 132.0 outside diameter 75.0 flange diameter flange depth	length 60.5 comp. height 28.8 +2.7 pin = 18.0 x 60.0 circlip not required MDO74676 MDO74677 MDO74680		top 1.5 2nd 1.5 oil 4.0 N-SWM31-062 R-20440/ 20490 T-33857 MDO74687 MDO78543 MD115490
			length 132.0 outside diameter 75.0 flange diameter flange depth	length 60.5 comp. height 28.8 +2.7 pin = 18.0 x 60.0 circlip not required MDO74676 MDO74677 MDO74680		top 1.5 2nd 1.5 oil 4.0 N-SWM31-062 R-20440/ 20490 T-33857 MDO74687 MDO78543 MD115490
mitsubishi 4G42 Bore Dia. 71.0 mm 4 cyl. 1,187 cc COLT LANCER	KBS63730	LB63730 length 140.0 outside diameter 73.9 flange diameter flange depth MDO30698	KB63730 length 58.8 comp. height 29.0 +0.8 pin = 18.0 x 60.0 circlip not required MDO30312	KR63730 top 1.5 2nd 1.5 oil 4.0 N-SWM31-026 R-20050 T-33858 MDO30350 MDO31670		
mitsubishi 4G13 G13B Bore Dia. 71.0 mm 4 cyl. 1,298 cc LANCER MIRAGE (86-) SOHC 12V	KBS63740	LB63740 length 132.0 outside diameter 75.0 flange diameter flange depth	KB63740 length 60.5 comp. height 28.8 +2.7 pin = 18.0 x 60.0 circlip not required MDO74676 MDO74677 MDO74680	KR63740 top 1.5 2nd 1.5 oil 4.0 N-SWM31-062 R-20440/ 20490 T-33857 MDO74687 MDO78543 MD115490		

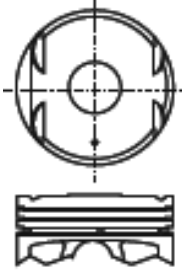
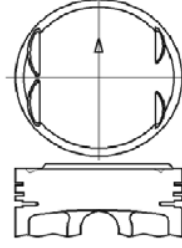
MOTOR - TYP	KOLBEN + RINGE PISTON + RINGS PISTONES + ANILLOS	LAUFBUCHSE CYL. SLEEVE CAMISAS	KOLBENSATZ PISTON SET PISTONES KIT	RINGSATZ RING SET ANILLOS	KOLBEN PISTON PISTONES
MITSUBISHI 4G13 Bore Dia. 71.0 mm 4 cyl. 1,298 cc LANCER MIRAGE (86-) SOHC 12V	KBS63741	LB63741 length 132.0 outside diameter 75.0 flange diameter flange depth	KB63741 length 58.3 comp. height 29.3 -1.1 pin = 18.0 x 60.0 circlip not required MDO99759	KR63741 top 1.5 2nd 1.5 oil 4.0 N-SWM31-062 R-20440/ 20490 T-33857 MDO74687 MDO78543 MD115490	
MITSUBISHI 4G13 New Bore Dia. 71.0 mm 4 cyl. 1,298 cc LANCER MIRAGE SPACE STAR (98-) SOHC 16V	KBS51500	LB51500 length 132.0 outside diameter 75.0 flange diameter flange depth	KB51500 length 59.85 comp. height 29.0 +1.85 pin = 18.0 x 56.0 circlip not required MD141804	KR51500 top 1.2 2nd 1.5 oil 3.0 N-SWM31-082 R-20004 T-33897 MD158908	
MITSUBISHI 4G13 New Bore Dia. 71.0 mm 4 cyl. 1,298 cc LANCER MIRAGE SPACE STAR (98-) SOHC 16V	KBS51501	LB51501 length 132.0 outside diameter 75.0 flange diameter flange depth	KB51501 length 59.8 comp. height 29.2 +1.8 pin = 18.0 x 56.0 circlip not required MD172036	KR51501 top 1.2 2nd 1.5 oil 3.0 N-SWM31-082 R-20004 T-33897 MD158908	

MOTOR - TYP	KOLBEN + RINGE PISTON + RINGS PISTONES + ANILLOS	LAUFBUCHSE CYL. SLEEVE CAMISAS	KOLBENSATZ PISTON SET PISTONES KIT	RINGSATZ RING SET ANILLOS	KOLBEN PISTON PISTONES
MITSUBISHI 4G13 Bore Dia. 71.0 mm 4 cyl. 1,298 cc LANCER	KBS63744	LB63744 length outside diameter flange diameter flange depth	KB63744 length 49.5 comp. height 28.5 +0.6	KR63744 top 1.2 2nd 1.5 oil 2.8	
			pin = 18.0 x 56.0 circlip not required MD351585 MD351586 MD351587 MD372629 MD372630	N-SWM31-141 R-20965 T-33944 MD335419 MD335420 MD335421 MD335422 MD335423 MD335424	
2012 NEW					
MITSUBISHI 4G17 Bore Dia. 72.2 mm 4 cyl. 1,343 cc COLT MIRAGE SOHC 12V	KBS63750	LB63750 length 130.0 outside diameter 76.2 flange diameter flange depth	KB63750 length 58.4 comp. height 29.0 +0.4	KR63750 top 1.2 2nd 1.5 oil 3.0	
			pin = 18.0 x 56.0 circlip not required MD173577	N-SWM31-099 R-20292 T-33900 MD165325	
MITSUBISHI KE44 Bore Dia. 73.0 mm 4 cyl. 1,088 cc COLT DELICA (66-68) OHV	KBS63760	LB63760 length outside diameter flange diameter flange depth	KB63760 length 73.8 comp. height 35.5 -4.6	KR63760 top 2.0 2nd 2.0 oil 4.0	
			pin = 18.0 x 64.0 circlip required K44-2032-3	N-SWM30-057 R-20350 T-33830 MD000770	

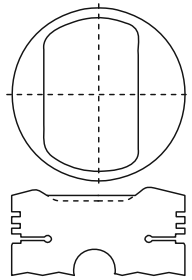
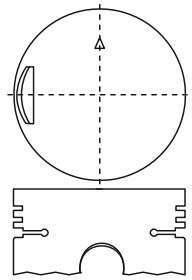
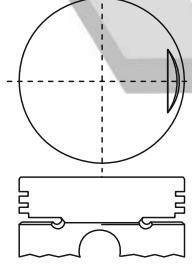
MOTOR - TYP	KOLBEN + RINGE PISTON + RINGS PISTONES + ANILLOS	LAUFBUCHSE CYL. SLEEVE CAMISAS	KOLBENSATZ PISTON SET PISTONES KIT	RINGSATZ RING SET ANILLOS	KOLBEN PISTON PISTONES
MITSUBISHI KE46 Bore Dia. 73.0 mm 4 cyl. 1,189 cc COLT (68) OHV	KBS63770	LB63770 length outside diameter flange diameter flange depth	length 76.0 comp. height 35.4 -5.8	top 2.0 2nd 2.0 oil 4.0	
			pin = 18.0 x 64.0 circlip required	N-SWM30-057 R-20350 T-33830	
			K46-2032-3	MDOOO770	
MITSUBISHI 4G30 Bore Dia. 73.0 mm 4 cyl. 1,289 cc COLT GALANT (69-73) SOHC 8V	KBS63780	LB63780 length outside diameter flange diameter flange depth	length 70.8 comp. height 33.8 +0	top 2.0 2nd 2.0 oil 4.0	
			pin = 19.0 x 64.0 circlip not required	N-SWM30-057 R-20350 T-33830	
			MDOOO645 MDOOO675	MDOOO770	
MITSUBISHI 4G33 Bore Dia. 73.0 mm 4 cyl. 1,439 cc GALENT LANCER (73-82) SOHC 8V	KBS63790	LB63790 length 150.0 outside diameter 77.0 flange diameter flange depth MDOO2290	length 69.8 comp. height 32.8 +0	top 2.0 2nd 2.0 oil 4.0	
			pin = 19.0 x 64.0 circlip not required	N-SWM30-057 R-20350 T-33830	
			MDOO2710 MDOO2851	MDOOO770	

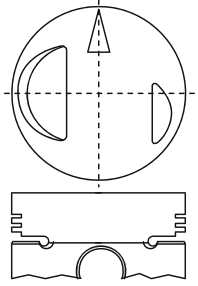
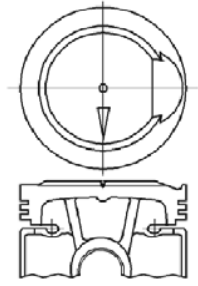
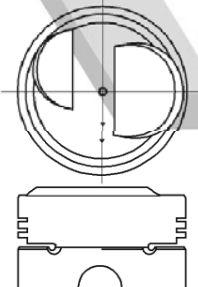
MOTOR - TYP	KOLBEN + RINGE PISTON + RING PISTONES + ANILLOS	LAUFBUCHSE CYL. SLEEVE CAMISAS	KOLBENSAT PISTON SET PISTONES KIT	RINGSATZ RING SET ANILLOS	KOLBEN PISTON PISTONES
MITSUBISHI 4G33 Bore Dia. 73.0 mm 4 cyl. 1,439 cc DELICA ` L300 FG15 ` FGC10 (82-) SOHC 8V	KBS63791	LB63791 length 150.0 outside diameter 77.0 flange diameter flange depth MDO02290	KB63791 length 70.2 comp. height 33.2 +0	KR63791 top 1.5 2nd 1.5 oil 4.0	
			pin = 19.0 x 64.0 circlip not required	N-SWM31-016/024 S XM31-024 R-20500/ 21550 T-33856/895/907	
			MDO09580 MDO09581 MDO09584	MDO09625 MDO34010 MD115500	
MITSUBISHI 4G36 Bore Dia. 73.0 mm 4 cyl. 1,238 cc COLT ` LANCER SOHC 8V	KBS63800	LB63800 length 150.0 outside diameter 77.0 flange diameter flange depth MDO02290	KB63800 length 81.0 comp. height 39.5 +2.0	KR63800 top 2.0 2nd 2.0 oil 4.0	
			pin = 19.0 x 64.0 circlip not required	N-SWM30-057 R-20350 T-33830	
			MDO00796	MDO00770	
MITSUBISHI 4G36 Bore Dia. 73.0 mm 4 cyl. 1,238 cc COLT ` LANCER (77-84) SOHC 8V	KBS63801	LB63801 length 150.0 outside diameter 77.0 flange diameter flange depth MDO02290	KB63801 length 82.5 comp. height 39.5 +3.5	KR63801 top 1.5 2nd 1.5 oil 4.0	
			pin = 19.0 x 64.0 circlip not required	N-SWM31-016/024 S XM3 1-024 R-20500/ 21550 T-33856/895/907	
			MDO09560 MDO09561	MDO09625 MDO34010 MD115500	

MOTOR - TYP	KOLBEN + RINGE PISTON + RINGS PISTONES + ANILLOS	LAUFBUCHSE CYL. SLEEVE CAMISAS	KOLBENSATZ PISTON SET PISTONES KIT	RINGSATZ RING SET ANILLOS	KOLBEN PISTON PISTONES
MITSUBISHI 4G12 G12B Bore Dia. 74.0 mm 4 cyl. 1,410 cc COLT MIRAGE (79-86) SOHC 8V	KBS63810	LB63810 length outside diameter flange diameter flange depth	KB63810 length 58.1 comp. 28.9 height -1.5 pin = 18.0 x 60.0 circlip not required MDO12008 MDO30322 MDO30327	KR63810 top 1.5 2nd 1.5 oil 4.0 N-SWM31-027 R-20910 T-33859 MDO12025 MDO12035 MDO30355 MDO31700	
			length 69.3 comp. 32.3 height +0	top 2.0 2nd 2.0 oil 4.0 N- R-20360 T-33831 MDO02645 MDO02675 MDO02770	
			length 50.3 comp. 26.8 height +0 pin = 17.0 x 45.5	top 1.2 2nd 1.5 oil 2.5 N- R- T-	
MITSUBISHI 4G31 Bore Dia. 74.5 mm 4 cyl. 1,499 cc LANCER MIRAGE (86-88) SOHC 8V	KBS63820	LB63820 length outside diameter flange diameter flange depth	KB63820 length 69.3 comp. 32.3 height +0 pin = 19.0 x 64.0 circlip not required MDO02645 MDO02675	KR63820 top 2.0 2nd 2.0 oil 4.0 N- R-20360 T-33831 MDO02770	
			length 50.3 comp. 26.8 height +0 pin = 17.0 x 45.5	top 1.2 2nd 1.5 oil 2.5 N- R- T-	
MITSUBISHI C12 Bore Dia. 74.5 mm 4 cyl. 1,499 cc COLT MIRAGE (84-88) SOHC 8V	KBS63830	LB63830 length outside diameter flange diameter flange depth	KB63830 length 50.3 comp. 26.8 height +0 pin = 17.0 x 45.5	KR63830 top 1.2 2nd 1.5 oil 2.5 N- R- T-	
			length 69.3 comp. 32.3 height +0	top 2.0 2nd 2.0 oil 4.0 N- R-20360 T-33831 MDO02645 MDO02675 MDO02770	
			length 50.3 comp. 26.8 height +0 pin = 17.0 x 45.5	top 1.2 2nd 1.5 oil 2.5 N- R- T-	

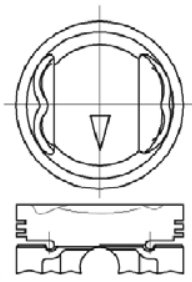
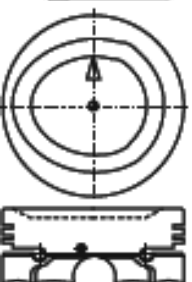
MOTOR - TYP	KOLBEN + RINGE PISTON + RINGS PISTONES + ANILLOS	LAUFBUCHSE CYL. SLEEVE CAMISAS	KOLBENSATZ PISTON SET PISTONES KIT	RINGSATZ RING SET ANILLOS	KOLBEN PISTON PISTONES
MITSUBISHI 4A91 Bore Dia. 75.0 mm 4 cyl. 1,499 cc COLT LANCER LANCER SPORTBACK CX2A CY2A Z36A (07-) DOHC 16V	KBS25500	LB25500 length outside diameter flange diameter flange depth	KB25500 length	KR25500 top 1.2 2nd 1.0 oil 2.0	
			pin = x circlip not required	N- R- T-	
			MN195611	MN195612	
MITSUBISHI 4G15 G15B Bore Dia. 75.5 mm 4 cyl. 1,468 cc COLT LANCER (84-) SOHC 8V	KBS63840	LB63840 length 140.0 outside diameter 79.5 flange diameter flange depth	KB63840 length 58.3 comp. height 29.1 -0.65	KR63840 top 1.5 2nd 1.5 oil 4.0	
			pin = 18.0 x 60.0 circlip not required	N-SWM31-063 R-20520 T-33876	
			MDO74715 MDO74720	MDO74725 MDO78548 MD104656	
MITSUBISHI 4G15 Bore Dia. 75.5 mm 4 cyl. 1,468 cc COLT LANCER (84-) SOHC 8V	KBS63850	LB63850 length 140.0 outside diameter 79.5 flange diameter flange depth	KB63850 length 58.3 comp. height 29.1 -3.6	KR63850 top 1.5 2nd 1.5 oil 4.0	
			pin = 18.0 x 60.0 circlip not required	N-SWM31-063 R-20520 T-33876	
			MDO99769 MDO99770	MDO74725 MDO78548 MD104656	

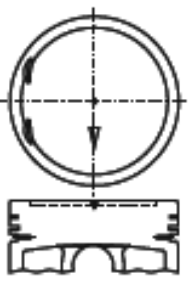
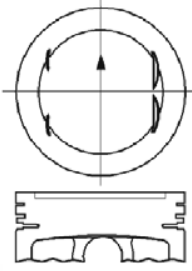
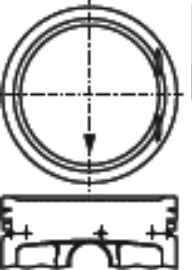
MOTOR - TYP	KOLBEN + RINGE PISTON + RINGS PISTONES + ANILLOS	LAUFBUCHSE CYL. SLEEVE CAMISAS	KOLBENSATZ PISTON SET PISTONES KIT	RINGSATZ RING SET ANILLOS	KOLBEN PISTON PISTONES
MITSUBISHI 4G15 New Bore Dia. 75.5 mm 4 cyl. 1,468cc LANCER MIRAGE (89-) SOHC 8V	KBS63851	LB63851 length 140.0 outside diameter 79.5 flange diameter flange depth	length 58.0 comp. height 29.0 -0.5	top 1.2 2nd 1.5 oil 3.0	
			pin = 18.0 x 56.0 circlip not required	N-SWM31-076/077 R-20630/20670 T-33898	
			MD143914 MD144901	MD158549 MD180804	
MITSUBISHI 4G15 New Bore Dia. 75.5 mm 4 cyl. 1,468 cc LANCER MIRAGE SOHC 12V	KBS63852	LB63852 length 140.0 outside diameter 79.5 flange diameter flange depth	length 58.0 comp. height 29.0 -0.45 -0.8	top 1.2 2nd 1.5 oil 3.0	
			pin = 18.0 x 56.0 circlip not required	N-SWM31-076/077 R-20630/20670 T-33898	
			MD320441	MD158549 MD180804	
MITSUBISHI 4G15-S3 Bore Dia. 75.5 mm 4 cyl. 1,468 cc LANCER MIRAGE SOHC 12V	KBS63860	LB63860 length 140.0 outside diameter 79.5 flange diameter flange depth	length 49.6 comp. height 28.6 -1.6	top 1.2 2nd 1.5 oil 2.8	
			pin = 18.0 x 56.0 circlip not required	N-SWM31-145 R-20999 T-33946	
			MD332841	MD332715 MD331313 MD333896	

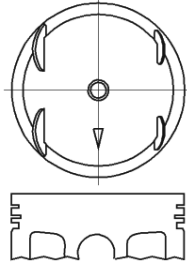
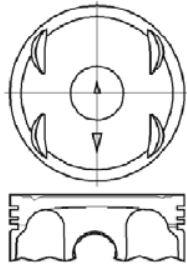
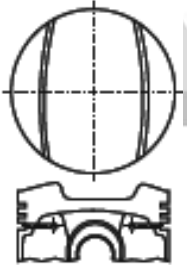
MOTOR - TYP	KOLBEN + RINGE PISTON + RINGS PISTONES + ANILLOS	LAUFBUCHSE CYL. SLEEVE CAMISAS	KOLBENSATZ PISTON SET PISTONES KIT	RINGSATZ RING SET ANILLOS	KOLBEN PISTON PISTONES
MITSUBISHI 4G18 Bore Dia. 76.0 mm 4 cyl. 1,584cc LANCER PROTON WAJA (01-) SOHC 16V	KBS52500	LB52500 length outside diameter flange diameter flange depth	KB52500 length 46.98 comp. height 25.98 +0 pin = x	KR52500 top 1.2 2nd 1.2 oil 2.5 N-SWM31-127 R-20007 T-33937/ 33938	
			MD349812	MD361982 MD361983	
MITSUBISHI 4G18-S4 Bore Dia. 76.0 mm 4 cyl. 1,584 cc LANCER PROTON WAJA (01-) SOHC 16V	KBS63870	LB63870 length outside diameter flange diameter flange depth	KB63870 length 46.98 comp. height 25.98 -0.54 pin = 18.0 x 55.0 circlip not required	KR63870 top 1.2 2nd 1.2 oil 2.5 N-SWM31-127 R-20007 T-33937/ 33938	
			MD367775 MD367776 MD367777	MD361982 MD361983	
MITSUBISHI 4G41 KE41 Bore Dia. 76.5 mm 4 cyl. 1,378 cc DELICA GALANT (71-79) OHV	KBS63880	LB63880 length 127.0 outside diameter 80.5 flange diameter flange depth	KB63880 length 74.0 comp. height 31.5 +4.0 pin = 19.0 x 64.0 circlip required	KR63880 top 2.0 2nd 2.0 oil 4.0 N-SWM30-078 R-20690 T-33839	
			MDO10670 MDO10680	MDO10710 MDO10715 MDO11893	

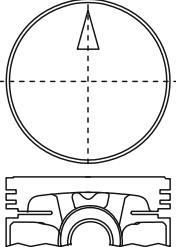
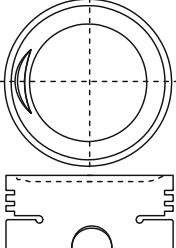
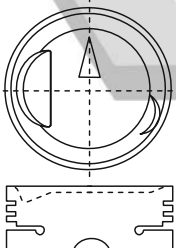
MOTOR - TYP	KOLBEN + RINGE PISTON + RINGS PISTONES + ANILLOS	LAUFBUCHSE CYL. SLEEVE CAMISAS	KOLBENSATZ PISTON SET PISTONES KIT	RINGSATZ RING SET ANILLOS	KOLBEN PISTON PISTONES
MITSUBISHI 4G41 G41R Bore Dia. 76.5 mm 4 cyl. 1,378 cc DELICA GALANT (71-79) OHV	KBS63890	LB63890 length 127.0 outside diameter 80.5 flange diameter flange depth	KB63890 length 69.3 comp. height 30.8 +0	KR63890 top 2.0 2nd 2.0 oil 4.0	
			pin = 19.0 x 64.0 circlip required MDO11940 MDO11941 MDO11951	N-SWM30-078 R-20690 T-33839 MDO10710 MDO10715 MDO11893	
MITSUBISHI 4G32 Bore Dia. 76.9 mm 4 cyl. 1,597 cc GALANT L300 LANCER SIGMA (80-) SOHC 8V	KBS63900	LB63900 length 150.0 outside diameter 80.9 flange diameter flange depth MDOO4233	KB63900 length 70.4 comp. height 33.5 -3.0	KR63900 top 2.0 2nd 2.0 oil 4.0	
			pin = 19.0 x 64.0 circlip not required MDOO4670	N-SWM31-005 R-20210 T-33832 MDOO0725 MDOO4709 MDOO4739 MDOO4770 MDOO5885 MDOO7251 MDOO8105 MD106741	
MITSUBISHI 4G32 G32R Bore Dia. 76.9 mm 4 cyl. 1,597 cc GALANT L300 LANCER SIGMA (80-) SOHC 8V	KBS63910	LB63910 length 150.0 outside diameter 80.9 flange diameter flange depth MDOO4233	KB63910 length 70.5 comp. height 33.6 -2.8	KR63910 top 2.0 2nd 2.0 oil 4.0	
			pin = 19.0 x 64.0 circlip not required MDOO4761 MDOO8851	N-SWM31-005 R-20210 T-33832 MDOO0725 MDOO4709 MDOO4739 MDOO4770 MDOO5885 MDOO7251 MDOO8105 MD106741	

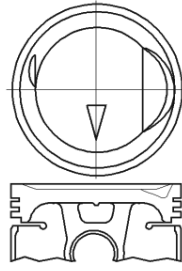
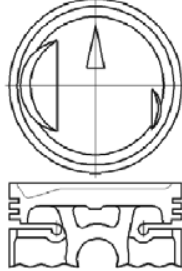
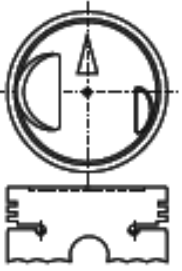
MOTOR - TYP	KOLBEN + RINGE PISTON + RINGS PISTONES + ANILLOS	LAUFBUCHSE CYL. SLEEVE CAMISAS	KOLBENSATZ PISTON SET PISTONES KIT	RINGSATZ RING SET ANILLOS	KOLBEN PISTON PISTONES
MITSUBISHI 4G32 G32J Bore Dia. 76.9 mm 4 cyl. 1,597 cc GALANT L300 LANCER SIGMA (80-) SOHC 8V	KBS63920	LB63920 length 150.0 outside diameter 80.9 flange diameter flange depth MDOO4233	KB63920 length 70.13 comp. height 33.0 -6.5 pin = 19.0 x 64.0 circlip required MDOO8854	KR63920 top 2.0 2nd 2.0 oil 4.0 N-SWM31-005 R-20210 T-33832 MDOO0725 MDOO4709 MDOO4739 MDOO4770 MDOO5885 MDOO7251 MDOO8105 MD106741	
MITSUBISHI 4G32 G32B Bore Dia. 76.9 mm 4 cyl. 1,597 cc GALANT L300 LANCER SIGMA (80-) SOHC 8V	KBS63930	LB63930 length 150.0 outside diameter 80.9 flange diameter flange depth MDOO4233	KB63930 length 70.5 comp. height 33.5 -7.2 pin = 19.0 x 64.0 circlip not required MDOO9520 MDOO9521	KR63930 top 2.0 2nd 2.0 oil 4.0 N-SWM31-005 R-20210 T-33832 MDOO0725 MDOO4709 MDOO4739 MDOO4770 MDOO5885 MDOO7251 MDOO8105 MD106741	
MITSUBISHI 4G32 G32S Bore Dia. 76.9 mm 4 cyl. 1,597 cc GALANT L300 LANCER SIGMA (80-) SOHC 8V	KBS63940	LB63940 length 150.0 outside diameter 80.9 flange diameter flange depth MDOO4233	KB63940 length 70.5 comp. height 33.5 -0.4 pin = 19.0 x 64.0 circlip not required MDOO4680 MDOO4767 MDOO8860 MDOO8861	KR63940 top 2.0 2nd 2.0 oil 4.0 N-SWM31-005 R-20210 T-33832 MDOO0725 MDOO4709 MDOO4739 MDOO4770 MDOO5885 MDOO7251 MDOO8105 MD106741	

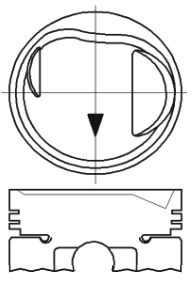
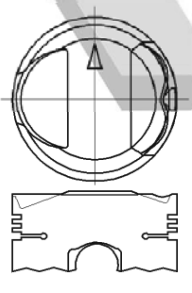
MOTOR - TYP	KOLBEN + RINGE PISTON + RINGS PISTONES + ANILLOS	LAUFBUCHSE CYL. SLEEVE CAMISAS	KOLBENSATZ PISTON SET PISTONES KIT	RINGSATZ RING SET ANILLOS	KOLBEN PISTON PISTONES
MITSUBISHI 4G32T Bore Dia. 76.9 mm 4 cyl. 1,597 cc GALANT L300 LANCER SIGMA (80-) SOHC 8V	KBS63950	LB63950 length 150.0 outside diameter 80.9 flange diameter flange depth MDO04233	KB63950 length 68.0 comp. height 34.0 -2.3 pin = 19.0 x 64.0 circlip not required MDO99925 MDO99926 MDO99927 MD105495	KR63950 top 1.5 2nd 1.5 oil 4.0 N-SWM31-043 R-20550 T-33870 MDO12765 MDO62387 MDO93337 MDO99430	
MITSUBISHI 4G91 Bore Dia. 78.4 mm 4 cyl. 1,496 cc LANCER MIRAGE DOHC 16V	KBS63960	LB63960 length outside diameter flange diameter flange depth	KB63960 length comp. height pin = x	KR63960 top 1.2 2nd 1.2 oil 2.8 N- R-20700 T-33945 MD177113	
MITSUBISHI 4G62 G62B Bore Dia. 80.6 mm 4 cyl. 1,795 cc GALANT LANCER SOHC 8V	KBS63970	LB63970 length 150.0 outside diameter 84.5 flange diameter flange depth MDO61685	KB63970 length 73.6 comp. height 35.0 +1.5 pin = 21.0 x 72.0 circlip not required MDO40571	KR63970 top 2.0 2nd 2.0 oil 4.0 N-SWM31-040 R-20680 T-33863 MDO40610 MD106736	

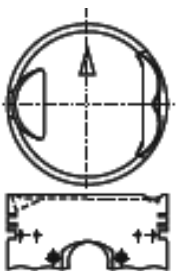
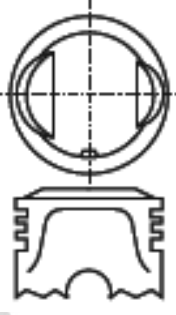
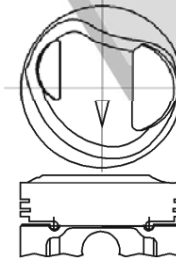
MOTOR - TYP	KOLBEN + RINGE PISTON + RINGS PISTONES + ANILLOS	LAUFBUCHSE CYL. SLEEVE CAMISAS	KOLBENSATZ PISTON SET PISTONES KIT	RINGSATZ RING SET ANILLOS	KOLBEN PISTON PISTONES
MITSUBISHI 4G62 G62BT Bore Dia. 80.6 mm 4 cyl. 1,795 cc GALANT LANCER SOHC 8V	KBS63980	LB63980 length 150.0 outside diameter 84.5 flange diameter flange depth MDO61685	KB63980 length 72.0 comp. height 35.0 -2.0 pin = 21.0 x 72.0 circlip not required MDO74221	KR63980 top 1.5 2nd 1.5 oil 4.0 N-SWM31-041 R-20681 T-33871 MDO40465	
			length 72.0 comp. height 35.0 -2.0 pin = 21.0 x 72.0 circlip not required MDO74221	KR63980 top 1.5 2nd 1.5 oil 4.0 N-SWM31-041 R-20681 T-33871 MDO40465	
			length 72.0 comp. height 35.0 -2.0 pin = 21.0 x 72.0 circlip not required MDO74221	KR63980 top 1.5 2nd 1.5 oil 4.0 N-SWM31-041 R-20681 T-33871 MDO40465	
			length 72.0 comp. height 35.0 -2.0 pin = 21.0 x 72.0 circlip not required MDO74221	KR63980 top 1.5 2nd 1.5 oil 4.0 N-SWM31-041 R-20681 T-33871 MDO40465	
MITSUBISHI 4G37 G37B Bore Dia. 80.6 mm 4 cyl. 1,755 cc GALANT SPACE WAGON (84-) SOHC 8V	KBS63990	LB63990 length outside diameter flange diameter flange depth	KB63990 length 75.5 comp. height 33.5 +7.0 pin = 19.0 x 64.0 circlip not required MDO74210	KR63990 top 1.5 2nd 1.5 oil 4.0 N- R-20530/ 20875 T-33885 MDO77113 MD106028 MD154012	
			length 75.5 comp. height 33.5 +7.0 pin = 19.0 x 64.0 circlip not required MDO74210	KR63990 top 1.5 2nd 1.5 oil 4.0 N- R-20530/ 20875 T-33885 MDO77113 MD106028 MD154012	
			length 75.5 comp. height 33.5 +7.0 pin = 19.0 x 64.0 circlip not required MDO74210	KR63990 top 1.5 2nd 1.5 oil 4.0 N- R-20530/ 20875 T-33885 MDO77113 MD106028 MD154012	
			length 75.5 comp. height 33.5 +7.0 pin = 19.0 x 64.0 circlip not required MDO74210	KR63990 top 1.5 2nd 1.5 oil 4.0 N- R-20530/ 20875 T-33885 MDO77113 MD106028 MD154012	
MITSUBISHI 4G37 Bore Dia. 80.6 mm 4 cyl. 1,755 cc GALANT SPACE WAGON (84-) SOHC 8V	KBS64000	LB64000 length outside diameter flange diameter flange depth	KB64000 length 71.8 comp. height 34.0 +3.8 pin = 19.0 x 64.0 circlip not required MD100416	KR64000 top 1.5 2nd 1.5 oil 4.0 N- R-20530/ 20875 T-33885 MDO77113 MD106028 MD154012	
			length 71.8 comp. height 34.0 +3.8 pin = 19.0 x 64.0 circlip not required MD100416	KR64000 top 1.5 2nd 1.5 oil 4.0 N- R-20530/ 20875 T-33885 MDO77113 MD106028 MD154012	
			length 71.8 comp. height 34.0 +3.8 pin = 19.0 x 64.0 circlip not required MD100416	KR64000 top 1.5 2nd 1.5 oil 4.0 N- R-20530/ 20875 T-33885 MDO77113 MD106028 MD154012	
			length 71.8 comp. height 34.0 +3.8 pin = 19.0 x 64.0 circlip not required MD100416	KR64000 top 1.5 2nd 1.5 oil 4.0 N- R-20530/ 20875 T-33885 MDO77113 MD106028 MD154012	

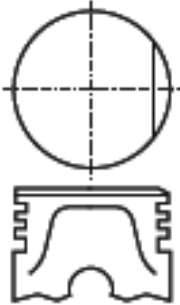
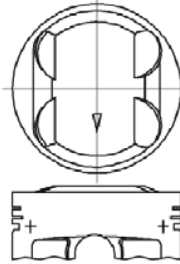
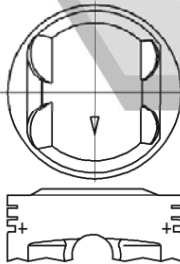
MOTOR - TYP	KOLBEN + RINGE PISTON + RINGS PISTONES + ANILLOS	LAUFBUCHSE CYL. SLEEVE CAMISAS	KOLBENSATZ PISTON SET PISTONES KIT	RINGSATZ RING SET ANILLOS	KOLBEN PISTON PISTONES
MITSUBISHI 4G51 Bore Dia. 81.0 mm 4 cyl. 1,850 cc GALANT (73-77) SOHC 8V	KBS64010	LB64010 length 146.0 outside diameter 85.0 flange diameter flange depth	KB64010 length 80.5 comp. height 38.0 +2.5 pin = 22.0 x 72.0 circlip not required MDO23031	KR64010 top 2.0 2nd 2.0 oil 4.0 N-SWM31-025 R-20560 T-33842 MDO23060	
MITSUBISHI 4G92 Bore Dia. 81.0 mm 4 cyl. 1,597 cc COLT LANCER (92-) DOHC 16V	KBS64020	LB64020 length outside diameter flange diameter flange depth	KB64020 length 62.1 comp. height 30.0 +3.1 pin = 19.0 x 58.0 circlip not required MD329140 MD329141 MD329142 MD329143 MD329144 MD329145 MD329146	KR64020 top 1.2 2nd 1.2 oil 2.8 N-SWM31-079 R-20740 T-33902 MD173206 MD173211	
MITSUBISHI 4G92 G92-S4 Bore Dia. 81.0 mm 4 cyl. 1,597 cc COLT LANCER (92-) DOHC 16V	KBS64030	LB64030 length outside diameter flange diameter flange depth	KB64030 length 61.4 comp. height 29.4 +3.0 pin = 19.0 x 58.0 circlip not required MD314274 MD314275 MD314276	KR64030 top 1.2 2nd 1.2 oil 2.8 N-SWM31-079 R-20740 T-33902 MD173206 MD173211	

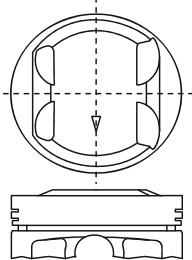
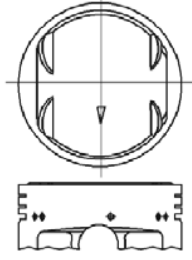
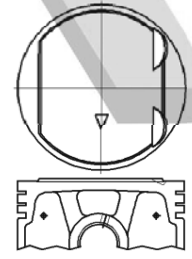
MOTOR - TYP	KOLBEN + RINGE PISTONES + ANILLOS	PISTON + RINGS LAUFBUCHSE CYL. SLEEVE CAMISAS	KOLBENSATZ Z PISTON SET PISTONES KIT	RINGSATZ RING SET ANILLOS	KOLBEN PISTON PISTONES
MITSUBISHI 4G92 Bore Dia. 81.0 mm 4 cyl. 1,597 cc COLT LANCER (92-) DOHC 16V	KBS64040 LB64040 KB64040 KR64040				
		length outside diameter flange diameter flange depth	length 62.3 comp. height 30.1 +3.27 pin = 19.0 x 58.0 circlip not required MD184676 XW530339-41	top 1.2 2nd 1.2 oil 2.8 N-SWM31-079 R-20740 T-33902 MD173206 MD173211	
MITSUBISHI 4G93 Bore Dia. 81.0 mm 4 cyl. 1,834 cc CARISMA SPACE STAR (97-) DOHC 16V	KBS64050 LB64050 KB64050 KR64050				
		length outside diameter flange diameter flange depth	length 60.1 comp. height 30.1 +1.0 pin = 19.0 x 58.0 circlip not required MD329139	top 1.2 2nd 1.2 oil 2.8 N-SWM31-079 R-20740 T-33902 MD173206 MD173211	
MITSUBISHI 4G93 Bore Dia. 81.0 mm 4 cyl. 1,834 cc COLT CARISMA LANCER (92-) SOHC 16V	KBS64051 LB64051 KB64051 KR64051				
		length outside diameter flange diameter flange depth	length 60.0 comp. height 30.8 +0.2 pin = 19.0 x 58.0 circlip not required MD190610 MD318097	top 1.2 2nd 1.2 oil 2.8 N-SWM31-079 R-20740 T-33902 MD173206 MD173211	

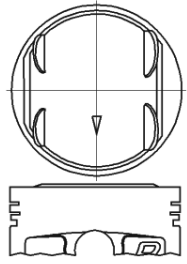
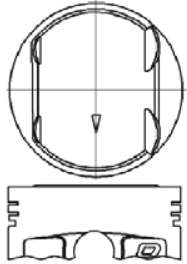
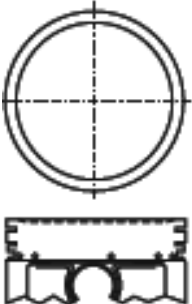
MOTOR - TYP	KOLBEN + RINGE PISTON + RINGS PISTONES + ANILLOS	LAUFBUCHSE CYL. SLEEVE CAMISAS	KOLBENSATZ PISTON SET PISTONES KIT	RINGSATZ RING SET ANILLOS	KOLBEN PISTON PISTONES
MITSUBISHI 4G93 Bore Dia. 81.0 mm 4 cyl. 1,834 cc CARISMA SPACE STAR (97-) DOHC 16V	KBS64052	LB64052 length outside diameter flange diameter flange depth	length 59.8 comp. height 30.8 +1.03	top 1.2 2nd 1.2 oil 2.8	
			pin = 19.0 x 58.0 circlip not required	N-SWM31-079 R-20740 T-33902	
			XW530330 XW530331 XW530332	MD173206 MD173211	
MITSUBISHI 4G93 Bore Dia. 81.0 mm 4 cyl. 1,834 cc CARISMA SPACE STAR (97-) DOHC 16V	KBS64053	LB64053 length outside diameter flange diameter flange depth	length 60.8 comp. height 30.8 +1.0	top 1.2 2nd 1.2 oil 2.8	
			pin = 19.0 x 58.0 circlip not required	N-SWM31-079 R-20740 T-33902	
			XW530336 XW530337 XW530338	MD173206 MD173211	
MITSUBISHI 4G94 Bore Dia. 81.5 mm 4 cyl. 1,999 cc LANCER SOHC 16V	KBS64060	LB64060 length 185.0 outside diameter 85.0 flange diameter flange depth	length 50.4 comp. height 30.4 -1.2	top 1.2 2nd 1.2 oil 2.5	
			pin = 19.0 x 58.0 circlip not required	N- R- T-33966	
			MD375974	1110B098 1110B099 1110B100	

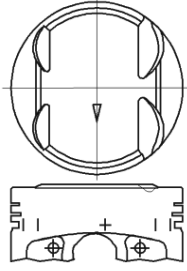
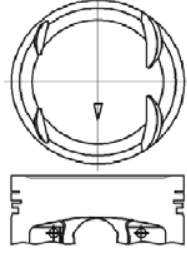
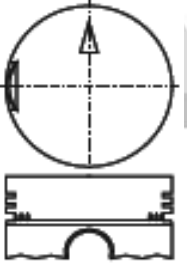
MOTOR - TYP	KOLBEN + RINGE PISTON + RINGS PISTONES + ANILLOS	LAUFBUCHSE CYL. SLEEVE CAMISAS	KOLBENSATZ PISTON SET PISTONES KIT	RINGSATZ RING SET ANILLOS	KOLBEN PISTON PISTONES
MITSUBISHI 4G61 Bore Dia. 82.3 mm 4 cyl. 1,596 cc COLT LANCER (87-92) DOHC 16V	KBS64070	LB64070 length outside diameter flange diameter flange depth	KB64070 length 66.0 comp. height 32.5 +1.5	KR64070 top 1.2 2nd 1.5 oil 3.0	
			pin = 21.0 x 66.0 circlip not required	N-SWM31-049 R-20787 T-33932	
			MD133485 MD133495		
MITSUBISHI 4G61-KC Bore Dia. 82.3 mm 4 cyl. 1,596 cc COLT LANCER (87-92) DOHC 16V	KBS64080	LB64080 length outside diameter flange diameter flange depth	KB64080 length 64.5 comp. height 32.5 -1.3	KR64080 top 1.2 2nd 1.5 oil 3.0	
			pin = 21.0 x 66.0 circlip not required	N-SWM31-049 R-20787 T-33932	
			MD135272	MD133485 MD133495	
MITSUBISHI 4G52 G52B Bore Dia. 84.0 mm 4 cyl. 1,995 cc CELESTE GALANT L300 SIGMA (72-) SOHC 8V	KBS64090	LB64090 length outside diameter flange diameter flange depth	KB64090 length 79.3 comp. height 39.6 -1.3	KR64090 top 2.0 2nd 2.0 oil 4.0	
			pin = 22.0 x 75.0 circlip not required	N-SWM30-074 R-20810 T-33845	
			MDO21000 MDO21058 MDO21063 MDO21192	MDO21010 MDO21035 MDO21070 MDO27010	

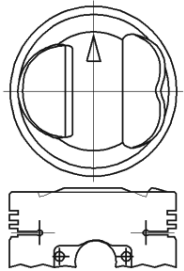
MOTOR - TYP	KOLBEN + RINGE PISTON + RINGS PISTONES + ANILLOS	LAUFBUCHSE CYL. SLEEVE CAMISAS	KOLBENSATZ PISTON SET PISTONES KIT	RINGSATZ RING SET ANILLOS	KOLBEN PISTON PISTONES	
MITSUBISHI 4G63 G63B Bore Dia. 85.0 mm 4 cyl. 1,997 cc GALANT L300 LANCER (80-) SOHC 8V	KBS64100	LB64100 length 150.0 outside diameter 89.0 flange diameter flange depth MDO40409	KB64100 length 74.0 comp. height 35.0 +2.0 pin = 21.0 x 72.0 circlip not required MDO40821 MDO41560	KR64100 top 2.0 2nd 2.0 oil 4.0 N-SWM31-013 R-20920 T-33866 MDO40640 MDO40840 MDO41580 MD108068		
			length 150.0 outside diameter 89.0 flange diameter flange depth MDO40409	length 72.4 comp. height 35.4 -8.0 pin = 21.0 x 72.0 circlip not required MD100372		top 1.5 2nd 1.5 oil 4.0 N-SWM31-034/044 SWM31-046 R-20820/ 20840 T-33892 MDO88941 MD100467 MD105516
			length 150.0 outside diameter 89.0 flange diameter flange depth MDO40409	length 72.0 comp. height 35.0 -0.9 pin = 21.0 x 72.0 circlip not required MDO40560 MDO40591		top 2.0 2nd 2.0 oil 4.0 N-SWM31-013 R-20920 T-33866 MDO40640 MDO40840 MDO41580 MD108068

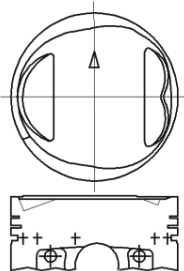
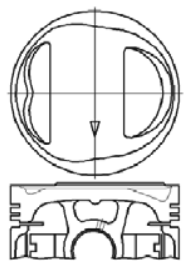
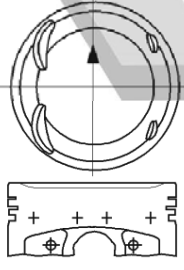
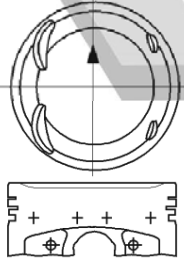

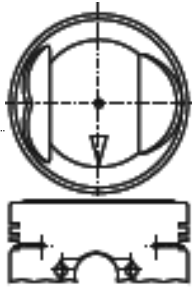
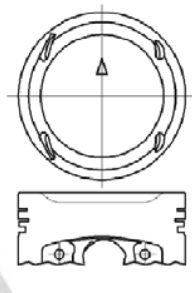
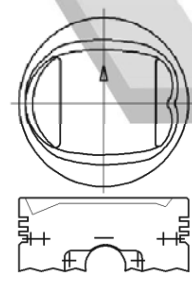
MOTOR - TYP	KOLBEN + RINGE PISTON + RINGS PISTONES + ANILLOS	LAUFBUCHSE CYL. SLEEVE CAMISAS	KOLBENSATZ PISTON SET PISTONES KIT	RINGSATZ RING SET ANILLOS	KOLBEN PISTON PISTONES	
MITSUBISHI 4G63 G63K Bore Dia. 85.0 mm 4 cyl. 1,997 cc ECLIPSE GALANT (87-) DOHC 16V	KBS64110	LB64110 length 150.0 outside diameter 89.0 flange diameter flange depth MDO40409	KB64110 length 67.5 comp. height 35.1 +0.4 pin = 22.0 x 62.0 circlip not required MD188289 MD188292	KR64110 top 1.2 2nd 1.5 oil 3.0 N-SWM31-048/071 R-20049/ 20657 T-33918/ 33924 MD133485 MD140923 MD195850		
			MD095215	N-SWM31-034/044 SWM31-046 R-20820/ 20840 T-33892 MDO88941 MD100467 MD105516		
			MDO40409	MDO88941 MD100467 MD105516		
			MDO40409	MDO88941 MD100467 MD105516		
MITSUBISHI 4G63 G63B Bore Dia. 85.0 mm 4 cyl. 1,997 cc GALANT PAJERO SHARIOT	KBS64103	LB64103 length 150.0 outside diameter 89.0 flange diameter flange depth MDO40409	KB64103 length 72.4 comp. height 35.0 +0.4 pin = 21.0 x 72.0 circlip not required MDO95215	KR64103 top 1.5 2nd 1.5 oil 4.0 N-SWM31-034/044 SWM31-046 R-20820/ 20840 T-33892 MDO88941 MD100467 MD105516		
			MDO40409	MDO88941 MD100467 MD105516		
			MDO40409	MDO88941 MD100467 MD105516		
			MDO40409	MDO88941 MD100467 MD105516		
MITSUBISHI 4G63 G63D Bore Dia. 85.0 mm 4 cyl. 1,997 cc ECLIPSE GALANT (87-) DOHC 16V	KBS64120	LB64120 length 150.0 outside diameter 89.0 flange diameter flange depth MDO40409	KB64120 length 67.0 comp. height 35.0 -2.2 pin = 21.0 x 66.0 circlip not required MD129922	KR64120 top 1.2 2nd 1.5 oil 3.0 N-SWM31-048/071 R-20049/ 20657 T-33918/ 33924 MD133485 MD140923 MD195850		
			MD129922	MD133485 MD140923 MD195850		
			MDO40409	MD133485 MD140923 MD195850		
			MDO40409	MD133485 MD140923 MD195850		

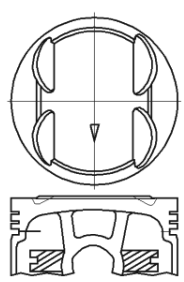
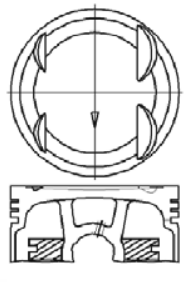
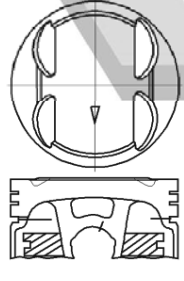

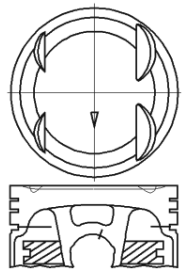
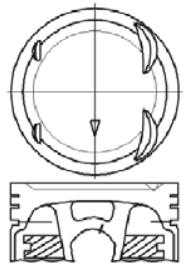
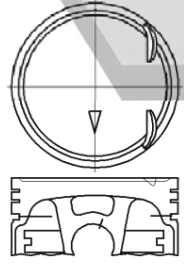
MOTOR - TYP	KOLBEN + RINGE PISTON + RINGS PISTONES + ANILLOS	LAUFBUCHSE CYL. SLEEVE CAMISAS	KOLBENSATZ PISTON SET PISTONES KIT	RINGSATZ RING SET ANILLOS	KOLBEN PISTON PISTONES
MITSUBISHI 4G63 Bore Dia. 85.0 mm 4 cyl. 1,997 cc ECLIPSE GALANT (87-) DOHC 16V	KBS64130	LB64130 length 150.0 outside diameter 89.0 flange diameter flange depth MDO40409	KB64130 length 69.0 comp. height 35.4 +1.6 pin = 22.0 x 62.0 circlip not required MD190256	KR64130 top 1.2 2nd 1.5 oil 3.0 N-SWM31-048/071 R-20049/ 20657 T-33918/ 33924 MD133485 MD140923 MD195850	
			length 67.0 comp. height 35.0 -5.4 pin = 21.0 x 66.0 circlip not required MD129232	top 1.2 2nd 1.5 oil 3.0 N-SWM31-048/071 R-20049/ 20657 T-33918/ 33924 MD133485 MD140923 MD195850	
			length 72.0 comp. height 35.0 -8.6 pin = 21.0 x 72.0 circlip not required MDO41641	top 2.0 2nd 2.0 oil 4.0 N-SWM31-013 R-20920 T-33866 MD108068 MDO40640 MDO40840 MDO41580	
MITSUBISHI 4G63T G63DT Bore Dia. 85.0 mm 4 cyl. 1,997 cc ECLIPSE GALANT (87-) DOHC 16V	KBS64140	LB64140 length 150.0 outside diameter 89.0 flange diameter flange depth MDO40409	KB64140 length 67.0 comp. height 35.0 -5.4 pin = 21.0 x 66.0 circlip not required MD129232	KR64140 top 1.2 2nd 1.5 oil 3.0 N-SWM31-048/071 R-20049/ 20657 T-33918/ 33924 MD133485 MD140923 MD195850	
			length 72.0 comp. height 35.0 -8.6 pin = 21.0 x 72.0 circlip not required MDO41641	top 2.0 2nd 2.0 oil 4.0 N-SWM31-013 R-20920 T-33866 MD108068 MDO40640 MDO40840 MDO41580	
MITSUBISHI 4G63T G63BTS Bore Dia. 85.0 mm 4 cyl. 1,997 cc GALANT L300 LANCER (80-) SOHC 8V	KBS64150	LB64150 length 150.0 outside diameter 89.0 flange diameter flange depth MDO40409	KB64150 length 72.0 comp. height 35.0 -8.6 pin = 21.0 x 72.0 circlip not required MDO41641	KR64150 top 2.0 2nd 2.0 oil 4.0 N-SWM31-013 R-20920 T-33866 MD108068 MDO40640 MDO40840 MDO41580	

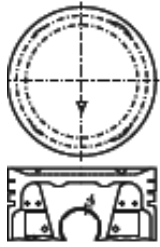
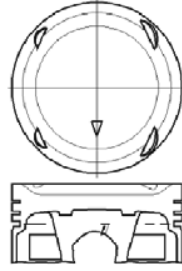
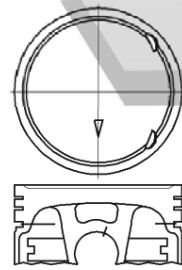
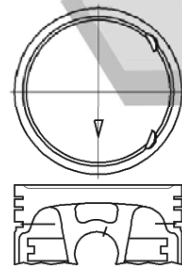
MOTOR - TYP	KOLBEN + RINGE PISTON + RINGS PISTONES + ANILLOS	LAUFBUCHSE CYL. SLEEVE CAMISAS	KOLBENSATZ PISTON SET PISTONES KIT	RINGSATZ RING SET ANILLOS	KOLBEN PISTON PISTONES
MITSUBISHI 4G63 G63DM Bore Dia. 85.0 mm 4 cyl. 1,997 cc ECLIPSE GALANT (87-) DOHC 16V	KBS64160	LB64160 length 150.0 outside diameter 89.0 flange diameter flange depth MDO40409	KB64160	KR64160	
			length 67.7 comp. height 35.0 +0.7 pin = 21.0 x 66.0 circlip not required MD158172	top 1.2 2nd 1.5 oil 3.0 N-SWM31-048/071 R-20049/ 20657 T-33918/ 33924 MD133485 MD140923 MD195850	
MITSUBISHI 4G63 G63DH Bore Dia. 85.0 mm 4 cyl. 1,997 cc ECLIPSE GALANT (87-) DOHC 16V	KBS64170	LB64170 length 150.0 outside diameter 89.0 flange diameter flange depth MDO40409	KB64170	KR64170	
			length 67.0 comp. height 35.0 -0.6 pin = 21.0 x 66.0 circlip not required MD129942	top 1.2 2nd 1.5 oil 3.0 N-SWM31-048/071 R-20049/ 20657 T-33918/ 33924 MD133485 MD140923 MD195850	
MITSUBISHI 4G63 G63DMK Bore Dia. 85.0 mm 4 cyl. 1,997 cc ECLIPSE GALANT (87-) DOHC 16V	KBS64180	LB64180 length 150.0 outside diameter 89.0 flange diameter flange depth MDO40409	KB64180	KR64180	
			length 67.7 comp. height 35.0 +0.7 pin = 22.0 x 62.0 circlip not required MD192212	top 1.2 2nd 1.5 oil 3.0 N-SWM31-048/071 R-20049/ 20657 T-33918/ 33924 MD133485 MD140923 MD195850	

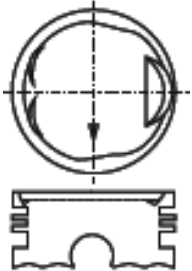
MOTOR - TYP	KOLBEN + RINGE PISTON + RINGS PISTONES + ANILLOS	LAUFBUCHSE CYL. SLEEVE CAMISAS	KOLBENSATZ PISTON SET PISTONES KIT	RINGSATZ RING SET ANILLOS	KOLBEN PISTON PISTONES
MITSUBISHI 4G63 G63DP Bore Dia. 85.0 mm 4 cyl. 1,997 cc ECLIPSE GALANT (87-) DOHC 16V	KBS64190	LB64190 length 150.0 outside diameter 89.0 flange diameter flange depth MDO40409	KB64190 length 67.0 comp. height 35.0 -0.6 pin = 22.0 x 62.0 circlip not required MD190268	KR64190 top 1.2 2nd 1.5 oil 3.0 N-SWM31-048/071 R-20049/ 20657 T-33918/ 33924 MD133485 MD140923 MD195850	
			length 67.0 comp. height 35.0 -2.3 pin = 22.0 x 62.0 circlip not required MD190262	top 1.2 2nd 1.5 oil 3.0 N-SWM31-048/071 R-20049/ 20657 T-33918/ 33924 MD133485 MD140923 MD195850	
			length 67.0 comp. height 35.0 -1.1 pin = 22.0 x 62.0 circlip not required MD193210 MD193226	top 1.2 2nd 1.5 oil 2.8 N-SWM31-103 R-20651/52/59 T-33919 MD108608 MD195805 MD195807 MD195809 MD195810 MD195812 MD195814 MD313405 MD313406 MD313407	
MITSUBISHI 4G63 G63DK Bore Dia. 85.0 mm 4 cyl. 1,997 cc ECLIPSE GALANT (87-) DOHC 16V	KBS64200	LB64200 length 150.0 outside diameter 89.0 flange diameter flange depth MDO40409	KB64200 length 67.0 comp. height 35.0 -2.3 pin = 22.0 x 62.0 circlip not required MD190262	KR64200 top 1.2 2nd 1.5 oil 3.0 N-SWM31-048/071 R-20049/ 20657 T-33918/ 33924 MD133485 MD140923 MD195850	
			length 67.0 comp. height 35.0 -1.1 pin = 22.0 x 62.0 circlip not required MD193210 MD193226	top 1.2 2nd 1.5 oil 2.8 N-SWM31-103 R-20651/52/59 T-33919 MD108608 MD195805 MD195807 MD195809 MD195810 MD195812 MD195814 MD313405 MD313406 MD313407	
MITSUBISHI 4G63 New G63SP New Bore Dia. 85.0 mm 4 cyl. 1,997 cc GALANT SPACE WAGON (92-) SOHC 16V	KBS64210	LB64210 length 150.0 outside diameter 89.0 flange diameter flange depth MDO40409	KB64210 length 67.0 comp. height 35.0 -1.1 pin = 22.0 x 62.0 circlip not required MD193210 MD193226	KR64210 top 1.2 2nd 1.5 oil 2.8 N-SWM31-103 R-20651/52/59 T-33919 MD108608 MD195805 MD195807 MD195809 MD195810 MD195812 MD195814 MD313405 MD313406 MD313407	
			length 67.0 comp. height 35.0 -1.1 pin = 22.0 x 62.0 circlip not required MD193210 MD193226	top 1.2 2nd 1.5 oil 2.8 N-SWM31-103 R-20651/52/59 T-33919 MD108608 MD195805 MD195807 MD195809 MD195810 MD195812 MD195814 MD313405 MD313406 MD313407	

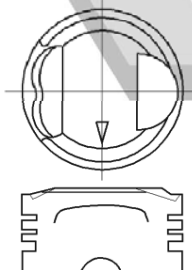
MOTOR - TYP	KOLBEN + RINGE PISTON + RINGS PISTONES + ANILLOS	LAUFBUCHSE CYL. SLEEVE CAMISAS	KOLBENSATZ PISTON SET PISTONES KIT	RINGSATZ RING SET ANILLOS	KOLBEN PISTON PISTONES
MITSUBISHI 4G63 New G63DT New Bore Dia. 85.0 mm 4 cyl. 1,997 cc	KBS64211	LB64211	KB64211	KR64211	
	head anodized	length 150.0 outside diameter 89.0 flange diameter flange depth MDO40409	length 67.0 comp. height 35.0 -3.3 pin = 22.0 x 62.0 circlip not required MD307820 MD307826 MD307828	top 1.2 2nd 1.5 oil 2.8 N-SWM31-103 R-20651/52/59 T-33919 MD108608 MD195805 MD195807 MD195809 MD195810 MD195812 MD195814 MD313405 MD313406 MD313407	
MITSUBISHI 4G63 Bore Dia. 85.0 mm 4 cyl. 1,997 cc	KBS64220	LB64220	KB64220	KR64220	
	head, top and 2nd ring lands anodized	length 150.0 outside diameter 89.0 flange diameter flange depth MDO40409	length 67.0 comp. height 35.0 -5.4 pin = 22.0 x 62.0 circlip not required MD308200	top 1.2 2nd 1.5 oil 3.0 N-SWM31-048/071 R-20049/ 20657 T-33918/ 33924 MD133485 MD140923 MD195850	
MITSUBISHI 4G63 New G63N New Bore Dia. 85.0 mm 4 cyl. 1,997 cc	KBS64230	LB64230	KB64230	KR64230	
		length 150.0 outside diameter 89.0 flange diameter flange depth MDO40409	length 67.0 comp. height 35.0 -1.8 pin = 22.0 x 62.0 circlip not required MD188097 MD188100	top 1.2 2nd 1.5 oil 2.8 N-SWM31-103 R-20651/52/59 T-33919 MD108608 MD195805 MD195807 MD195809 MD195810 MD195812 MD195814 MD313405 MD313406 MD313407	
MITSUBISHI 4G63 New G63N New Bore Dia. 85.0 mm 4 cyl. 1,997 cc					
	GALANT SPACE WAGON (92-) SOHC 16V				

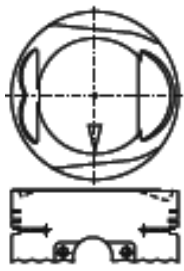
MOTOR - TYP	KOLBEN + RINGE PISTON + RINGS PISTONES + ANILLOS	LAUFBUCHSE CYL. SLEEVE CAMISAS	KOLBENSATZ PISTON SET PISTONES KIT	RINGSATZ RING SET ANILLOS	KOLBEN PISTON PISTONES			
MITSUBISHI 4G63 Bore Dia. 85.0 mm 4 cyl. 1,997 cc ECLIPSE GALANT (87-) DOHC 16V	KBS64240	LB64240 length 150.0 outside diameter 89.0 flange diameter flange depth MDO40409	KB64240 length 67.0 comp. height 35.4 -4.7 pin = 22.0 x 62.0 circlip not required MD190244	KR64240 top 1.2 2nd 1.5 oil 3.0 N-SWM31-048/071 R-20049/ 20657 T-33918/ 33924 MD133485 MD140923 MD195850				
			length 150.0 outside diameter 89.0 flange diameter flange depth MDO40409	length 54.65 comp. height 34.65 -1.3 pin = 22.0 x 62.0 circlip not required MD376648 MD376649 MD376650		top 1.2 2nd 1.2 oil 2.0 N-SWM31-143 R-20270 T- MD370449 MN149594		
			length 155.0 outside diameter 90.0 flange diameter flange depth	length 73.0 comp. height 35.0 +1.0 pin = 21.0 x 72.0 circlip required MDO68759		top 1.5 2nd 1.5 oil 4.0 N-SWM31-037/045 R-20085 T-33935 MD103580 MD103581 MD103582 MD103583 MD103584 MDO85346		
			length 150.0 outside diameter 89.0 flange diameter flange depth MDO40409	length 54.65 comp. height 34.65 -1.3 pin = 22.0 x 62.0 circlip not required MD376648 MD376649 MD376650		top 1.2 2nd 1.2 oil 2.0 N-SWM31-143 R-20270 T- MD370449 MN149594		

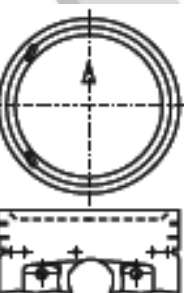
MOTOR - TYP	KOLBEN + RINGE PISTON + RINGS PISTONES + ANILLOS	LAUFBUCHSE CYL. SLEEVE CAMISAS	KOLBENSATZ PISTON SET PISTONES KIT	RINGSATZ RING SET ANILLOS	KOLBEN PISTON PISTONES
MITSUBISHI 4G64 G64B Bore Dia. 86.5 mm 4 cyl. 2,351 cc DELICA L200 (85-) SOHC 8V	KBS64251	LB64251 length 155.0 outside diameter 90.0 flange diameter flange depth	KB64251	KR64251	
			length 72.4 comp. height 35.0 +0.4 pin = 21.0 x 72.0 circlip not required MD105376 MD105377 MD105378 MD105383 MD105384 MD105385 MD105386	top 1.5 2nd 1.5 oil 4.0 N-SWM31-037/045 R-20085 T-33935 MD103580 MD103581 MD103582 MD103583 MD103584 MDO85346	
MITSUBISHI 4G64 G64K Bore Dia. 86.5 mm 4 cyl. 2,351 cc GALANT L200 L300 PAJERO SPACE WAGON (85-) SOHC 8V	KBS64260	LB64260 length 155.0 outside diameter 90.0 flange diameter flange depth	KB64260	KR64260	
			length 67.0 comp. height 35.0 +0.2 pin = 22.0 x 62.0 circlip not required MD188997 MD188998 MD188999 MD194657 MD194659	top 1.2 2nd 1.5 oil 3.0 N-SWM31-072 R-20155 T-33925 MD195872	
MITSUBISHI 4G64 Bore Dia. 86.5 mm 4 cyl. 2,351 cc ECLIPSE GALANT SPACE GEAR SPACE WAGON (93-99) SOHC 16V	KBS64270	LB64270 length 155.0 outside diameter 90.0 flange diameter flange depth	KB64270	KR64270	
			length 67.0 comp. height 35.0 -4.1 pin = 22.0 x 62.0 circlip not required MD188115 MD303071 MD303074	top 1.2 2nd 1.5 oil 2.8 N-SWM31-116 R-20291 / 20654 T-33936 / 33957 MD192815 MD194597 MD195828	

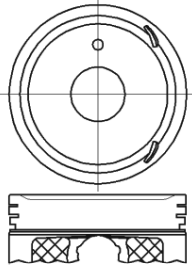
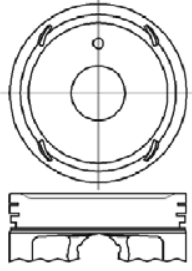
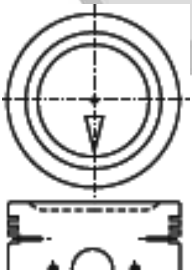

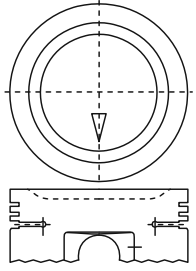
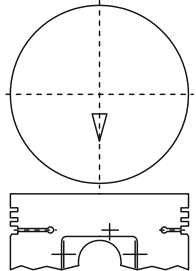
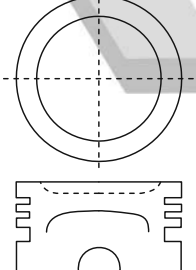
MOTOR - TYP	KOLBEN + RINGE PISTON + RINGS PISTONES + ANILLOS	LAUFBUCHSE CYL. SLEEVE CAMISAS	KOLBENSATZ PISTON SET PISTONES KIT	RINGSATZ RING SET ANILLOS	KOLBEN PISTON PISTONES
MITSUBISHI 4G69 Bore Dia. 87.0 mm 4 cyl. 2,378 cc ECLIPSE GRANDIS OUTLANDER (03-) SOHC 16V	KBS80000 skirt MOS2 treated	LB80000 length outside diameter flange diameter flange depth	KB80000	KR80000	
			length 59.0 comp. height 28.0 -0.7 -1.8	top 1.2 2nd 1.2 oil 2.0	
			pin = 22.0 x 62.0 circlip not required	N- R- T-	
			MN163080		
MITSUBISHI 4G69 Bore Dia. 87.0 mm 4 cyl. 2,378 cc GALANT (03-) DOHC 16V	KBS80001	LB80001 length outside diameter flange diameter flange depth	KB80001	KR80001	
			length 59.0 comp. height 28.0 -0.7 -1.8	top 1.2 2nd 1.2 oil 2.0	
			pin = 22.0 x 62.0 circlip not required	N- R- T-	
			1110B496		
MITSUBISHI 4G53 Bore Dia. 88.0 mm 4 cyl. 2,384 cc CANTER JEEP ROSA (74-81) SOHC 8V	KBS64280	LB64280 length outside diameter flange diameter flange depth	KB64280	KR64280	
			length 74.9 comp. height 34.9 -4.3	top 2.0 2nd 2.0 oil 4.0	
			pin = 22.0 x 75.0 circlip not required	N-SWM31-021 R-20950 T-33846	
			MDO24921	MDO25000 MDO26985	

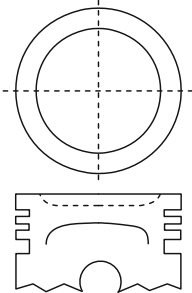
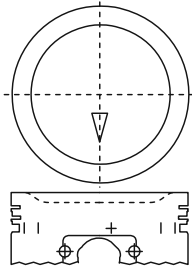
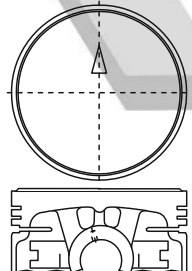
MOTOR - TYP	KOLBEN + RINGE PISTON + RINGS PISTONES + ANILLOS	LAUFBUCHSE CYL. SLEEVE CAMISAS	KOLBENSATZ PISTON SET PISTONES KIT	RINGSATZ RING SET ANILLOS	KOLBEN PISTON PISTONES
MITSUBISHI 4G54 G54B Bore Dia. 91.1 mm 4 cyl. 2,555 cc CANTER GALANT JEEP PAJERO SHOGUN (78-) SOHC 8V	KBS64290	LB64290 length 165.0 outside diameter 95.1 flange diameter flange depth	KB64290 length 77.0 comp. height 35.0 -5.0 pin = 22.0 x 79.0 circlip not required	KR64290 top 2.0 2nd 2.0 oil 4.0 N-SWM31-047 R-20231 / 20990 T-33860	
			MDO24946 MDO24947 MDO24990 MDO24991 MDO26860 MDO26861 MDO26870 MDO26871	MDO25089 MDO26835 MDO26960 MDO27140 MD107813 MD107818	
MITSUBISHI 4G54 G54B Bore Dia. 91.1 mm 4 cyl. 2,555 cc CANTER GALANT JEEP PAJERO SHOGUN (78-) SOHC 8V	KBS64291	LB64291 length 165.0 outside diameter 95.1 flange diameter flange depth	KB64291 length 77.5 comp. height 35.5 +0 pin = 22.0 x 79.0 circlip not required	KR64291 top 2.0 2nd 2.0 oil 4.0 N-SWM31-047 R-20231 / 20990 T-33860	
			MDO26921	MDO25089 MDO26835 MDO26960 MDO27140 MD107813 MD107818	
MITSUBISHI 4G54 G54B Bore Dia. 91.1 mm 4 cyl. 2,555 cc CANTER GALANT JEEP PAJERO SHOGUN (78-) SOHC 8V	KBS64292	LB64292 length 165.0 outside diameter 95.1 flange diameter flange depth	KB64292 length 77.2 comp. height 35.2 -5.0 pin = 22.0 x 79.0 circlip not required	KR64292 top 2.0 2nd 2.0 oil 4.0 N-SWM31-047 R-20231 / 20990 T-33860	
			MDO26940	MDO25089 MDO26835 MDO26960 MDO27140 MD107813 MD107818	

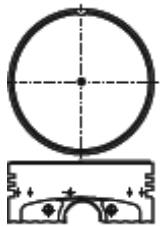
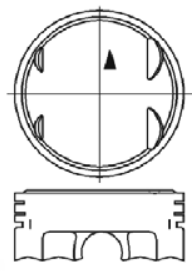
MOTOR - TYP	KOLBEN + RINGE PISTON + RINGS PISTONES + ANILLOS	LAUFBUCHSE CYL. SLEEVE CAMISAS	KOLBENSATZ PISTON SET PISTONES KIT	RINGSATZ RING SET ANILLOS	KOLBEN PISTON PISTONES
MITSUBISHI 4G54 G54B Bore Dia. 91.1 mm 4 cyl. 2,555 cc PAJERO STARION (82-) SOHC 8V	KBS64293	LB64293 length 165.0 outside diameter 95.1 flange diameter flange depth	KB64293 length 77.2 comp. height 35.2 -3.0 pin = 22.0 x 79.0 circlip not required MDO80394	KR64293 top 1.5 2nd 1.5 oil 4.0 N-SWM31-039 R-20998 T-33872/ 33929 33931 MDO61258 MDO76170 MDO80598 MD101895 MD106752	
			MDO61248 MD128450	MDO61258 MDO76170 MDO80598 MD101895 MD106752	
			MDO71172	MDO61258 MDO76170 MDO80598 MD101895 MD106752	
MITSUBISHI 4G54T G54BT Bore Dia. 91.1 mm 4 cyl. 2,555 cc PAJERO STARION (82-) SOHC 8V	KBS64300	LB64300 length 165.0 outside diameter 95.1 flange diameter flange depth	KB64300 length 76.9 comp. height 34.9 -5.1 pin = 22.0 x 79.0 circlip not required MDO61248 MD128450	KR64300 top 1.5 2nd 1.5 oil 4.0 N-SWM31-039 R-20998 T-33872/ 33929 33931 MDO61258 MDO76170 MDO80598 MD101895 MD106752	
			MDO61248 MD128450	MDO61258 MDO76170 MDO80598 MD101895 MD106752	
			MDO71172	MDO61258 MDO76170 MDO80598 MD101895 MD106752	
MITSUBISHI 4G54 G54B Bore Dia. 91.1 mm 4 cyl. 2,555 cc PAJERO STARION (82-) SOHC 8V	KBS64310	LB64310 length 165.0 outside diameter 95.1 flange diameter flange depth	KB64310 length 78.3 comp. height 36.0 +0.3 pin = 22.0 x 79.0 circlip not required MDO71172	KR64310 top 1.5 2nd 1.5 oil 4.0 N-SWM31-039 R-20998 T-33872/ 33929 33931 MDO61258 MDO76170 MDO80598 MD101895 MD106752	
			MDO61248 MD128450	MDO61258 MDO76170 MDO80598 MD101895 MD106752	
			MDO71172	MDO61258 MDO76170 MDO80598 MD101895 MD106752	

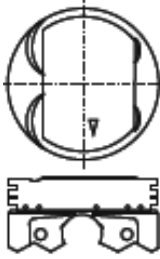
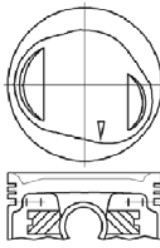
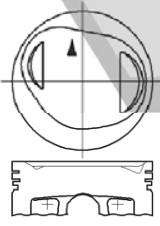
MOTOR - TYP	KOLBEN + RINGE PISTON + RINGS PISTONES + ANILLOS	LAUFBUCHSE CYL. SLEEVE CAMISAS	KOLBENSATZ PISTON SET PISTONES KIT	RINGSATZ RING SET ANILLOS	KOLBEN PISTON PISTONES
MITSUBISHI 4G54 G54B Bore Dia. 91.1 mm 4 cyl. 2,555 cc PAJERO STARION (82-) SOHC 8V	KBS64311	LB64311 length 165.0 outside diameter 95.1 flange diameter flange depth	KB64311 length 71.3 comp. height 36.0 +0.3 pin = 22.0 x 69.0 circlip not required	KR64311 top 1.5 2nd 1.5 oil 4.0 N-SWM31-039 R-20998 T-33872/ 33929 33931 MDO61258 MDO76170 MDO80598 MD101895 MD106752	
			MDO92515		
MITSUBISHI 6A12 ST-41 (L/R) Bore Dia. 78.4 mm 6 cyl. 1,998 cc DIAMANTE PROTON (92-) SOHC 24V	KBS64320	LB64320 length 115.0 outside diameter 82.4 flange diameter flange depth	KB64320 length 55.2 comp. height 28.7 +1.0 pin = 19.0 x 58.0 circlip not required	KR64320 top 1.2 2nd 1.2 oil 2.8 N-SWM31-137 R-20205 T-33940/ 33941 MD189104 MD302644 MD302645 MD302646 MD302648	
			MD352494 MD356498		
MITSUBISHI 6A12 Bore Dia. 78.4 mm 6 cyl. 1,998 cc GALANT SALOON E54A (93-02) DOHC 24V	KBS64330	LB64330 length 115.0 outside diameter 82.4 flange diameter flange depth	KB64330 length comp. height pin = x circlip not required	KR64330 top 1.2 2nd 1.2 oil 2.8 N-SWM31-137 R-20205 T-33940/ 33941 MD186824 MD186825 MD186826 MD186838 MD186839 MD186840 MD186841	
			MD186824 MD186825 MD186826 MD186838 MD186839 MD186840 MD186841		

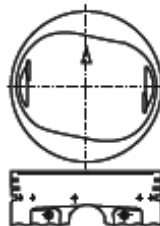
MOTOR - TYP	KOLBEN + RINGE PISTON + RINGS PISTONES + ANILLOS	LAUFBUCHSE CYL. SLEEVE CAMISAS	KOLBENSATZ PISTON SET PISTONES KIT	RINGSATZ RING SET ANILLOS	KOLBEN PISTON PISTONES
MITSUBISHI 6G73 (L/R) Bore Dia. 83.5 mm 6 cyl. 2,497 cc DIAMANTE GALANT (90-02) SOHC 24V	KBS64340	LB64340 length outside diameter flange diameter flange depth	KB64340 length 64.0 comp. height 31.9 +0.1 -2.9 pin = 22.0 x 64.0 circlip not required	KR64340 top 1.2 2nd 1.5 oil 3.0 N- R- T-33951	
			MD309393(R) MD309399(L)	MD310257 MD310258	
MITSUBISHI 6G72 (L/R) Bore Dia. 91.1 mm 6 cyl. 2,972 cc DIAMANTE GALANT MONTERO PAJERO (87-) SOHC 12V	KBS64350	LB64350 length outside diameter flange diameter flange depth	KB64350 length 68.2 comp. height 32.2 -3.0 pin = 22.0 x 64.0 circlip not required	KR64350 top 1.5 2nd 1.5 oil 4.0 N-SWM31-069/080 R-20006 T-33890	
			MD119671 MD152563 MD152562 MD152564 MD152576 MD152577 MD152578	MD101895 MD104922 MD104923 MD104939 MD104940 MD129548	
MITSUBISHI 6G72 (L/R) Bore Dia. 91.1 mm 6 cyl. 2,972 cc DIAMANTE GALANT MONTERO PAJERO (87-) SOHC 12V	KBS64351	LB64351 length outside diameter flange diameter flange depth	KB64351 length 66.2 comp. height 32.2 -3.0 pin = 22.0 x 64.0 circlip not required	KR64351 top 1.2 2nd 1.5 oil 3.0 N-SWM31-078 R-20793 T-33920	
			MD197808 MD197814	MD158344 MD165949 MD301803	

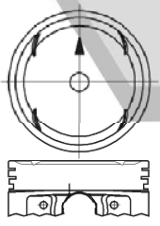

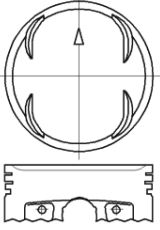
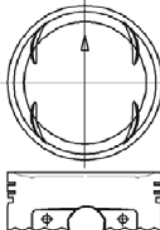
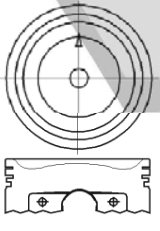
MOTOR - TYP	KOLBEN + RINGE PISTON + RINGS PISTONES + ANILLOS	LAUFBUCHSE CYL. SLEEVE CAMISAS	KOLBENSATZ PISTON SET PISTONES KIT	RINGSATZ RING SET ANILLOS	KOLBEN PISTON PISTONES
MITSUBISHI 6G72 Bore Dia. 91.1 mm 6 cyl. 2,972 cc DIAMANTE GALANT MONTERO PAJERO (87-) SOHC 12V	KBS87500	LB87500 length outside diameter flange diameter flange depth	length 65.9 comp. height 31.9 -0.3	top 1.2 2nd 1.5 oil 3.0	
			pin = 22.0 x 64.0 circlip not required	N-SWM31-078 R-20793 T-33920	
			MD307944 MD194548	MD158344 MD165949 MD301803	
MITSUBISHI 6G72 Bore Dia. 91.1 mm 6 cyl. 2,972 cc PAJERO SIGMA DIAMANTE (88-) DOHC	KBS87501	LB87501 length outside diameter flange diameter flange depth	length 65.8 comp. height 31.9 +0.5	top 1.2 2nd 1.5 oil 3.0	
			pin = 22.0 x 64.0 circlip not required	N-SWM31-078 R-20793 T-33920	
			MD307957 MD307958 MD307959 MD307964 MD307966	MD158344 MD165949 MD301803	
MITSUBISHI 6G72 (L/R) Bore Dia. 91.1 mm 6 cyl. 2,972 cc 3000GT PAJERO MONTERO (92-) DOHC	KBS64352	LB64352 length outside diameter flange diameter flange depth	length 65.7 comp. height 31.8 -2.5	top 1.2 2nd 1.5 oil 3.0	
			pin = 22.0 x 64.0 circlip not required	N-SWM31-078 R-20793 T-33920	
			MD318500 MD318501 MD318502 MD318506 MD318507	MD158344 MD165949 MD301803	

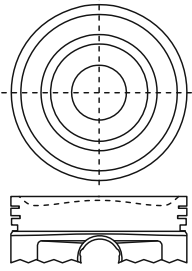
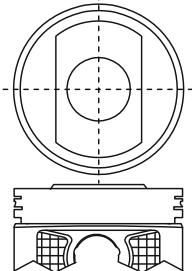
MOTOR - TYP	KOLBEN + RINGE PISTON + RINGS PISTONES + ANILLOS	LAUFBUCHSE CYL. SLEEVE CAMISAS	KOLBENSATZ PISTON SET PISTONES KIT	RINGSATZ RING SET ANILLOS	KOLBEN PISTON PISTONES
MITSUBISHI 6G72T Bore Dia. 91.1 mm 6 cyl. 2,972 cc 3000GT (92-) DOHC 24V	KBS64360	LB64360 length outside diameter flange diameter flange depth	KB64360 length 66.0 comp. height 32.0 -3.4 -4.3	KR64360 top 1.2 2nd 1.5 oil 3.0	
			pin = 22.0 x 64.0 circlip not required	N-SWM31-078 R-20793 T-33920	
			MD307972	MD158344 MD165949 MD301803	
MITSUBISHI 6G74 Bore Dia. 93.0 mm 6 cyl. 3,497 cc PAJERO (94-97) DOHC 24V	KBS64370	LB64370 length 195.0 outside diameter 97.0 flange diameter flange depth	KB64370 length 65.9 comp. height 32.0 -2.7	KR64370 top 1.5 2nd 1.5 oil 3.0	
			pin = 22.0 x 64.0 circlip required	N-SWM31-121 R-20018 T-33933	
			MD308276	MD300569 MD322783 MD369575	
MITSUBISHI 6G74 Bore Dia. 93.0 mm 6 cyl. 3,497 cc PAJERO (97-) SOHC 24V	KBS64371	LB64371 length 195.0 outside diameter 97.0 flange diameter flange depth	KB64371 length 65.2 comp. height 31.2 -6.0	KR64371 top 1.5 2nd 1.5 oil 3.0	
			pin = 22.0 x 64.0 circlip required	N-SWM31-121 R-20018 T-33933	
			MD334469	MD300569 MD322783 MD369575	

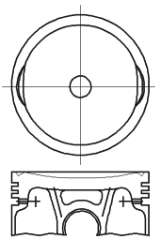
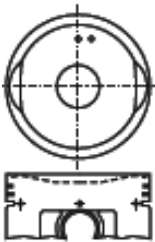
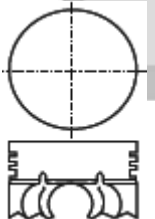
MOTOR - TYP	KOLBEN + RINGE PISTON + RINGS PISTONES + ANILLOS	LAUFBUCHSE CYL. SLEEVE CAMISAS	KOLBENSATZ PISTON SET PISTONES KIT	RINGSATZ RING SET ANILLOS	KOLBEN PISTON PISTONES
MITSUBISHI 6G74 Bore Dia. 93.0 mm 6 cyl. 3,497 cc TRITON MONTERO K89W K99W KB9T V75W (00-) DOHC 24V	KBS64372 head, top and 2nd ring lands anodized	LB64372 length 195.0 outside diameter 97.0 flange diameter flange depth	KB64372 length 64.0 comp. height 30.0 -1.5 -4.6	KR64372 top 1.5 2nd 1.5 oil 3.0	
			pin = 22.0 x 64.0 circlip required	N-SWM31-121 R-20018 T-33933	
			MD371361 MD371362 MD371363 MN149037 MN149038 MN149039	MD300569 MD322783 MD369575	
MITSUBISHI 6G75 Bore Dia. 95.0 mm 6 cyl. 3,796 cc ENDEAVOR GALANT MONTERO D71W D81W DJ3A V77W (03-) DOHC 24V	KBS64380 head, top and 2nd ring lands anodized skirt MOS2 treated	LB64380 length outside diameter flange diameter flange depth	KB64380 length 56.7 comp. height 29.1 +0.2	KR64380 top 1.2 2nd 1.2 oil 2.0	
			pin = 22.0 x 58.0 circlip required	N- R- T-	
			MN183040 MN183041 MN183042	MN183867	
		length outside diameter flange diameter flange depth	length comp. height pin = x	top 2nd oil N- R- T-	

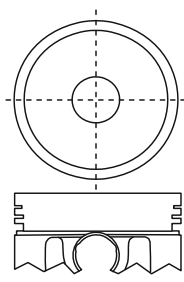
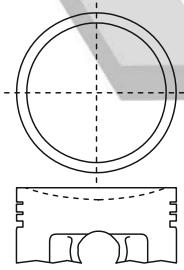
MOTOR - TYP	KOLBEN + RINGE PISTON + RINGS PISTONES + ANILLOS	LAUFBUCHSE CYL. SLEEVE CAMISAS	KOLBENSATZ PISTON SET PISTONES KIT	RINGSATZ RING SET ANILLOS	KOLBEN PISTON PISTONES
NISSAN MA10 Bore Dia. 68.0 mm 4 cyl. 987 cc MARCH MICRA (82-) SOHC 8V	KBS64390	LB64390 length outside diameter flange diameter flange depth	length 52.5 comp. height 26.5 -2.1 pin = 17.0 x 58.0 circlip not required	top 1.5 2nd 1.5 oil 2.8 N-SWN30-051/076 R-23030 T-34090	
			12010-10B06	12033-01B00 12033-01B05 12033-01B10 12033-01B11 12033-22B00 12033-23B00 12035-01B05 12035-01B10 12035-22B00	
NISSAN MA10S Bore Dia. 68.0 mm 4 cyl. 987 cc MARCH MICRA K10 (82-90) SOHC 8V	KBS64400	LB64400 length outside diameter flange diameter flange depth	length 52.5 comp. height 26.5 -3.7 pin = 17.0 x 58.0 circlip not required	top 1.5 2nd 1.5 oil 2.8 N-SWN30-051/076 R-23030 T-34090	
			12010-01B01/02 12010-01B03/04 12010-01B05/06 12010-22B00/01 12010-22B02/03 12010-22B04/71 12010-24B00/01 12010-24B02/03 12010-24B04/71	12033-01B00 12033-01B05 12033-01B10 12033-01B11 12033-22B00 12033-23B00 12035-01B05 12035-01B10 12035-22B00	
NISSAN D7F 722 Bore Dia. 69.0 mm 4 cyl. 1,149 cc KUBISTAR X76 (03-) SOHC 8V	KBS64410	LB64410 length outside diameter flange diameter flange depth	length 50.5 comp. height 27.1 +0 pin = 17.5 x 54.0 circlip not required	top 1.5 2nd 1.5 oil 2.5 N- R- T- 12033-00QAE	
			12010-00QAH 12010-00QAJ 12010-00QAK 12010-00QAL		

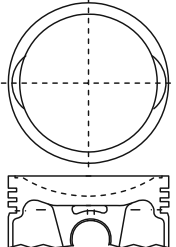
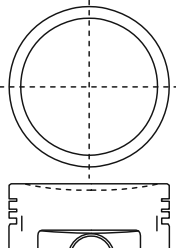
MOTOR - TYP	KOLBEN + RINGE PISTON + RINGS PISTONES + ANILLOS	LAUFBUCHSE CYL. SLEEVE CAMISAS	KOLBENSATZ PISTON SET PISTONES KIT	RINGSATZ RING SET ANILLOS	KOLBEN PISTON PISTONES
NISSAN D4F 712/730 Bore Dia. 69.0 mm 4 cyl. 1,149 cc	KBS64420 12010-00QAM 12010-00QAN 12010-00QAX 12010-00QAY	LB64420 length outside diameter flange diameter flange depth	KB64420 length 44.7 comp. height 26.7 -1.0	KR64420 top 1.2 2nd 1.5 oil 2.5	
			pin = 17.5 x 54.0 circlip not required	N- R- T- 12033-00QAJ	
KUBISTAR X76 (03-) SOHC 8V					
NISSAN CG10DE Bore Dia. 71.0 mm 4 cyl. 998 cc	KBS42500	LB42500 length outside diameter flange diameter flange depth	KB42500 length 49.5 comp. height 28.0 +0	KR42500 top 1.2 2nd 1.5 oil 3.0	
			pin = 18.0 x 58.0 circlip not required	N-SWN30-110/112 R- T- 12011-41B00 12033-41B00 12033-41B01 12035-41B00 12035-41B01	
MARCH MICRA K11 (92-99) DOHC 16V					
NISSAN CG13DE Bore Dia. 71.0 mm 4 cyl. 1,275 cc	KBS43500	LB43500 length outside diameter flange diameter flange depth	KB43500 length 49.5 comp. height 28.0 -5.5	KR43500 top 1.2 2nd 1.5 oil 3.0	
			pin = 18.0 x 58.0 circlip not required	N-SWN30-110/112 R- T- 12010-41B01 12010-44B00 12033-41B00 12033-41B01 12035-41B00 12035-41B01	
MARCH MICRA K11 (92-00) DOHC 16V					

MOTOR - TYP	KOLBEN + RINGE PISTON + RINGS PISTONES + ANILLOS	LAUFBUCHSE CYL. SLEEVE CAMISAS	KOLBENSATZ PISTON SET PISTONES KIT	RINGSATZ RING SET ANILLOS	KOLBEN PISTON PISTONES
NISSAN MA12S Bore Dia. 71.0 mm 4 cyl. 1,235 cc MICRA K10 (86-88) SOHC 8V	KBS84500	LB84500	length 54.7	top 1.5	
			outside diameter flange diameter flange depth	comp. height -9.4 pin = 17.0 x 58.0 circlip not required 12010-05B01/02/03 12010-05B04/05/06 12010-18B02/03/61 12010-18B62/63/64 12010-18B65/71/72 12010-18B73/74/75	
NISSAN GA13 GA13DS Bore Dia. 71.0 mm 4 cyl. 1,295 cc SENTRA SUNNY	KBS43520	LB43520	length 133.0	top 1.5	
			outside diameter 75.0 flange diameter flange depth	length 53.6 comp. height -2.8 pin = 19.0 x 47.0 circlip required A2010-72Y00 A2010-72Y01	
NISSAN CG10DE Bore Dia. 71.0 mm 4 cyl. 998 cc MICRA K12E (02-05) DOHC 16V	KBS42501	LB42501	length	top	
			outside diameter flange diameter flange depth	length comp. height pin = x 12010-BX000 12010-BX001 12010-BX002 12010-BX060	

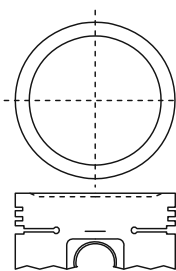
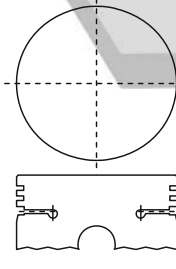
MOTOR - TYP	KOLBEN + RINGE PISTON + RINGS PISTONES + ANILLOS	LAUFBUCHSE CYL. SLEEVE CAMISAS	KOLBENSATZ PISTON SET PISTONES KIT	RINGSATZ RING SET ANILLOS	KOLBEN PISTON PISTONES
NISSAN CR12DE Bore Dia. 71.0 mm 4 cyl. 997 cc MICRA K12E (05-) DOHC 16V	KBS79000	LB79000 length outside diameter flange diameter flange depth	KB79000 length comp. height pin = x	KR79000 top 2nd oil N- R- T-	
			12010-BX010 12010-BX011 12010-BX012 12010-BX070	12033-BX000 12035-BX000	
NISSAN A12S Bore Dia. 73.0 mm 4 cyl. 1,171 cc CHERRY SUNNY N10 (71-82) OHV 8V	KBS79010	LB79010 length 122.0 outside diameter 77.0 flange diameter flange depth 11012-H1000 11012-H1011	KB79010 length 67.4 comp. height 32.4 -1.55 pin = 17.45 x 65.5 circlip not required	KR79010 top 2.0 2nd 2.0 oil 4.0 N-SWN30-026/080 R-23431 T-34001	
			12010-H1001 12010-H1011 12010-H1061 12010-H1062 12010-H1064 12010-H1065 12010-H1066 12010-H1067	12033-A6200 12033-B3040 12033-H6200 12033-H6201 12033-H6211 12035-H6200 12035-H6201 12037-H6200 12037-H6201	
NISSAN J13 Bore Dia. 73.0 mm 4 cyl. 1,299 cc PICK UP (67-69) OHV 8V	KBS79020	LB79020 length 132.0 outside diameter 77.0 flange diameter flange depth	KB79020 length 67.5 comp. height 32.55 +0 pin = 17.45 x 65.6 circlip not required	KR79020 top 2.0 2nd 2.0 oil 4.0 N-SWN30-026/080 R-23431 T-34001	
			12010-13201 12010-B5101	12033-A6200 12033-B3040 12033-H6200 12033-H6201 12033-H6211 12035-H6200 12035-H6201 12037-H6200 12037-H6201	

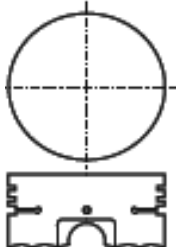
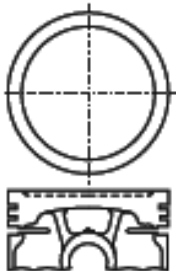
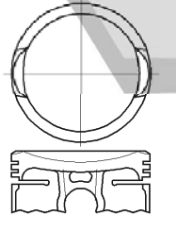
MOTOR - TYP	KOLBEN + RINGE PISTON + RINGS PISTONES + ANILLOS	LAUFBUCHSE CYL. SLEEVE CAMISAS	KOLBENSATZ PISTON SET PISTONES KIT	RINGSATZ RING SET ANILLOS	KOLBEN PISTON PISTONES
NISSAN A10S Bore Dia. 73.0 mm 4 cyl. 988 cc CHERRY SUNNY N10 (67-82) OHV 8V	KBS79030	LB79030 length 122.0 outside diameter 77.0 flange diameter flange depth 11012-H1000 11012-H1011	KB79030 length 67.5 comp. height 32.7 +0 pin = 17.45 x 65.5 circlip not required	KR79030 top 2.0 2nd 2.0 oil 4.0 N-SWN30-026/080 R-23431 T-34001 12033-A6200 12033-B3040 12033-H6200 12033-H6201 12033-H6211 12035-H6200 12035-H6201 12037-H6200 12037-H6201	
			12010-18021 12010-H2301 12010-H2361 12010-H2362 12010-H2364 12010-H2366		
NISSAN A13 Bore Dia. 73.0 mm 4 cyl. 1,288 cc SUNNY (74) OHV 8V	KBS79040	LB79040 length outside diameter flange diameter flange depth	KB79040 length 67.5 comp. height 32.65 -0.7 pin = 17.45 x 65.6 circlip not required	KR79040 top 2.0 2nd 2.0 oil 4.0 N-SWN30-026/080 R-23431 T-34001 12033-A6200 12033-B3040 12033-H6200 12033-H6201 12033-H6211 12035-H6200 12035-H6201 12037-H6200 12037-H6201	
			12010-H6201 12010-H6211		
NISSAN E10S Bore Dia. 73.0 mm 4 cyl. 980 cc CHERRY SUNNY PULSAR N10 N12 (82-86) SOHC 8V	KBS79050	LB79050 length outside diameter flange diameter flange depth	KB79050 length 57.1 comp. height 28.04 -5.42 pin = 17.45 x 62.0 circlip not required	KR79050 top 1.5 2nd 1.5 oil 4.0 N-SWN30-095 R-23053 T-34067 12033-41M01 12033-41M02 12033-60M00 12034-60M00 12035-41M01 12035-41M02 12035-60M00	
			12010-41M02 12010-41M03 12010-41M04		

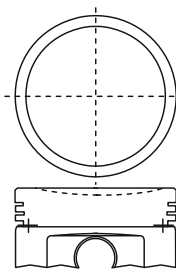
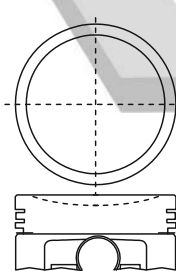
MOTOR - TYP	KOLBEN + RINGE PISTON + RINGS PISTONES + ANILLOS	LAUFBUCHSE CYL. SLEEVE CAMISAS	KOLBENSATZ PISTON SET PISTONES KIT	RINGSATZ RING SET ANILLOS	KOLBEN PISTON PISTONES
NISSAN CR14DE Bore Dia. 73.0 mm 4 cyl. 1,386 cc MICRA MICRA C+C NDTE CK12E E11E K12E (05-) DOHC 16V	KBS44500	LB44500 length outside diameter flange diameter flange depth	KB44500 length comp. height pin = x	KR44500 top 1.2 2nd 1.2 oil 2.0 N-SWN30-137/138 R- T-	
			12010-BX020 12010-BX021 12010-BX022 12010-BX080	12033-AX201 12033-BX010 12035-AX200 12035-BX010	
NISSAN GA14S Bore Dia. 73.6 mm 4 cyl. 1,392 cc ALMERA PULSAR SUNNY N14 N15 (90-01) DOHC 16V	KBS44510	LB44510 length 140.0 outside diameter 77.6 flange diameter flange depth	KB44510 length 55.0 comp. height 32.6 -3.1 pin = 19.0 x 50.0 circlip required	KR44510 top 1.5 2nd 1.5 oil 2.8 N-SWN30-103 R-23292 / 23999 T-34081 / 34084	
			A2010-73Y00 A2010-73Y01 A2010-73Y02 A2010-73Y10 A2010-73Y11 A2010-73Y60 A2010-73Y61 A2010-73Y62 A2010-73Y72 A2010-73Y73	12033-53Y00 12033-87A00 12033-87A10 12033-87A11 12036-87A10 12036-87A11 12038-87A10 12038-87A11	
NISSAN GA15DS Bore Dia. 73.6 mm 4 cyl. 1,497 cc PULSAR SENTRA SUNNY (90-93) SOHC 12V	KBS44520	LB44520 length outside diameter flange diameter flange depth	KB44520 length 51.9 comp. height 29.5 -4.8 pin = 19.0 x 49.0 circlip required	KR44520 top 1.5 2nd 1.5 oil 2.8 N-SWN30-103 R-23292 / 23999 T-34081 / 34084	
			A2010-53Y00 A2010-53Y01	12033-53Y00 12033-87A00 12033-87A10 12033-87A11 12036-87A10 12036-87A11 12038-87A10 12038-87A11	

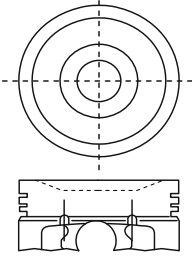
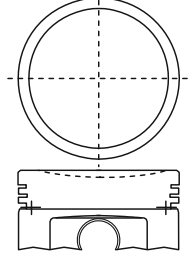
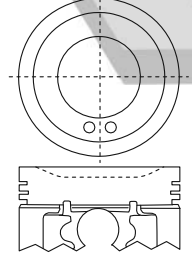

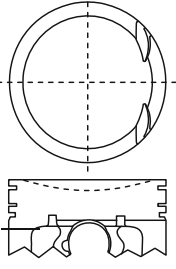
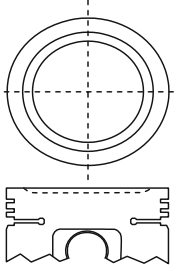
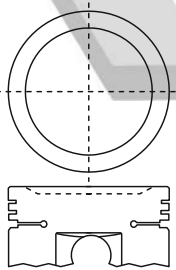
MOTOR - TYP	KOLBEN + RINGE PISTON + RINGS PISTONES + ANILLOS	LAUFBUCHSE CYL. SLEEVE CAMISAS	KOLBENSATZ PISTON SET PISTONES KIT	RINGSATZ RING SET ANILLOS	KOLBEN PISTON PISTONES
NISSAN GA15 Bore Dia. 73.6 mm 4 cyl. 1,497 cc SENTRA SOHC 12V	KBS44530	LB44530 length outside diameter flange diameter flange depth	KB44530 length 51.6 comp. height 29.15 -4.8 pin = 19.0 x 49.0 circlip required A2010-39751 A2010-39752	KR44530 top 1.5 2nd 1.5 oil 2.8 N-SWN30-103 R-23292/ 23999 T-34081 / 34084 12033-53Y00 12033-87A00 12033-87A10 12033-87A11 12036-87A10 12036-87A11 12038-87A10 12038-87A11	
			length 140.0 outside diameter 77.6 flange diameter flange depth	KB44540 length 55.2 comp. height 32.6 -4.0 pin = 19.0 x 50.0 circlip required 12010-87A61 12010-87A62 12010-87A63	
NISSAN GA14DE GA14DS Bore Dia. 73.6 mm 4 cyl. 1,392 cc PULSAR SENTRA N13 (88) SOHC 12V	KBS44540	LB44540 length 140.0 outside diameter 77.6 flange diameter flange depth	KB44540 length 55.2 comp. height 32.6 -4.0 pin = 19.0 x 50.0 circlip required 12010-87A61 12010-87A62 12010-87A63	KR44540 top 1.5 2nd 1.5 oil 2.8 N-SWN30-103 R-23292/ 23999 T-34081 / 34084 12033-53Y00 12033-87A00 12033-87A10 12033-87A11 12036-87A10 12036-87A11 12038-87A10 12038-87A11	
			length 51.6 outside diameter flange diameter flange depth	KB15001 length 51.6 comp. height 29.1 -4.8 pin = 19.0 x 49.0 circlip required 12010-7M600	
NISSAN QG15 Bore Dia. 73.6 mm 4 cyl. 1,497 cc ALMERA DOHC 16V	KBS15001	LB15001 length outside diameter flange diameter flange depth	KB15001 length 51.6 comp. height 29.1 -4.8 pin = 19.0 x 49.0 circlip required 12010-7M600	KR15001 top 1.5 2nd 1.5 oil 2.8 N-SWN30-103 R-23292/ 23999 T-34081 / 34084 12033-53Y00 12033-87A00 12033-87A10 12033-87A11 12036-87A10 12036-87A11 12038-87A10 12038-87A11	

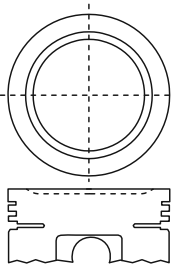
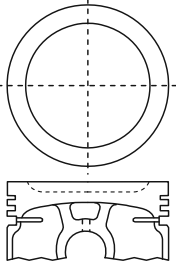
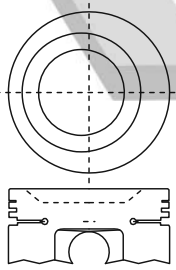
MOTOR - TYP	KOLBEN + RINGE PISTON + RINGS PISTONES + ANILLOS	LAUFBUCHSE CYL. SLEEVE CAMISAS	KOLBENSATZ PISTON SET PISTONES KIT	RINGSATZ RING SET ANILLOS	KOLBEN PISTON PISTONES
NISSAN QG15DE Bore Dia. 73.6 mm 4 cyl. 1,497 cc	KBS15000 head, top and 2nd ring lands anodized	LB15000 length outside diameter flange diameter flange depth	KB15000 length 51.6 comp. height 29.2 -4.8	KR15000 top 1.2 2nd 1.2 oil 2.5	
			pin = 19.0 x 49.0 circlip required A2010-BN900 A2010-BN901 A2010-BN902 A2010-BN972 A2010-BN974	N- R-23295 T- 12033-5M370 12036-5M370 12038-5M360	
NISSAN A12A Bore Dia. 75.0 mm 4 cyl. 1,237 cc	KBS15010	LB15010 length 122.0 outside diameter 79.0 flange diameter flange depth	KB15010 length 67.5 comp. height 32.6 -2.5	KR15010 top 2.0 2nd 2.0 oil 4.0	
			pin = 19.0 x 63.0 circlip not required 12010-H9502 12010-H9512	N-SWN30-073 R-23390 T-34037 12033-H8500	
NISSAN A14S Bore Dia. 75.0 mm 4 cyl. 1,397 cc	KBS15020	LB15020 length 138.0 outside diameter 80.0 flange diameter flange depth 11012-H7200 11012-H7685 11012-H9700 11012-H9820	KB15020 length 67.5 comp. height 32.5 -3.2	KR15020 top 2.0 2nd 2.0 oil 4.0	
			pin = 19.0 x 63.0 circlip not required 12010-H7511 12010-H7521 12010-H7524 12010-H7526 12010-H7561 12010-H7564 12010-H7566 12010-H7680 12010-H7685	N-SWN30-045 R-23221 T-34606 12033-H7200 12033-H8660 12033-H8900 12033-H8910 12033-H8920 12033-H9910 12035-H7200 12035-H8910/20 12037-H7200 12037-H8910/20	
ALMERA N16E (02-) DOHC 16V					
PULSAR SUNNY (80-82) SOHC 8V					
CHERRY PULSAR N10 (77-82) OHV 8V					

MOTOR - TYP	KOLBEN + RINGE PISTON + RINGS PISTONES + ANILLOS	LAUFBUCHSE CYL. SLEEVE CAMISAS	KOLBENSATZ PISTON SET PISTONES KIT	RINGSATZ RING SET ANILLOS	KOLBEN PISTON PISTONES
NISSAN A14 Bore Dia. 76.0 mm 4 cyl. 1,397 cc	KBS15030	LB15030 length 138.0 outside diameter 80.0 flange diameter flange depth 11012-H7200 11012-H7685 11012-H9700 11012-H9820	KB15030 length 67.5 comp. height 32.5 -2.3 pin = 19.0 x 63.0 circlip not required 12010-H7201 12010-H7211 12010-H7711	KR15030 top 2.0 2nd 2.0 oil 4.0	
				N-SWN30-045 R-23221 T-34606 12033-H7200 12033-H8660 12033-H8900 12033-H8910 12033-H8920 12033-H9910 12035-H7200 12035-H8910/20 12037-H7200 12037-H8910/20	
SUNNY VANETTE (75-82) OHV 8V	KBS15040	LB15040 length 138.0 outside diameter 80.0 flange diameter flange depth 11012-H7200 11012-H7685 11012-H9700 11012-H9820	KB15040 length 67.5 comp. height 32.5 -4.0 pin = 19.0 x 63.0 circlip not required 12010-H8702	KR15040 top 1.2 2nd 2.0 oil 4.0	
N-SWN30-052 R-23130/ 23971 T-34038 12033-H7680 12033-H9800 12033-H9810 12033-H9820 12033-H9915 12033-H9918 12035-H9810/20 12035-H9860 12037-H9800 12037-H9810/20					
SUNNY VANETTE (75-82) OHV 8V	KBS15050	LB15050 length 138.0 outside diameter 80.0 flange diameter flange depth 11012-H7200 11012-H7685 11012-H9700 11012-H9820	KB15050 length 65.5 comp. height 30.0 -6.5 pin = 19.0 x 63.0 circlip not required 12010-G3400 12010-G3405 12010-G3411 12010-G3414/16 12010-G3421 12010-G3424/26 12010-G3462 12010-G3465/67 12010-H9261 12010-H9800	KR15050 top 1.2 2nd 2.0 oil 4.0	
N-SWN30-052 R-23130/ 23971 T-34038 12033-H7680 12033-H9800 12033-H9810 12033-H9820 12033-H9915 12033-H9918 12035-H9810/20 12035-H9860 12037-H9800 12037-H9810/20					
VANETTE C120 GC22 (81-92) OHV 8V					

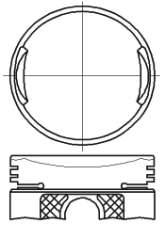
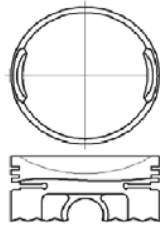
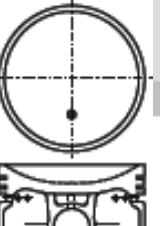

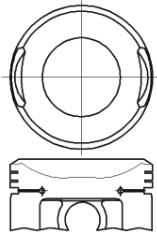
NISSAN

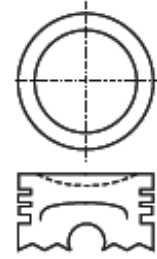
MOTOR - TYP	KOLBEN + RINGE PISTON + RINGS PISTONES + ANILLOS	LAUFBUCHSE CYL. SLEEVE CAMISAS	KOLBENSATZ PISTON SET PISTONES KIT	RINGSATZ RING SET ANILLOS	KOLBEN PISTON PISTONES
NISSAN E13 Bore Dia. 76.0 mm 4 cyl. 1,270 cc CHERRY SUNNY B11 N10 N12 N13 (81-88) SOHC 8V	KBS15060	LB15060 length outside diameter flange diameter flange depth	KB15060 length 62.5 comp. height 32.5 -6.92 pin = 19.0 x 62.0 circlip not required	KR15060 top 1.5 2nd 1.5 oil 4.0 N-SWN30-057/114 SXN30-060 R-23021 / 23081 23140 / 23993 T-34053	
			12010-01M00 12010-01M02 12010-01M04 12010-01M12 12010-01M14 12010-01M22 12010-01M24 12010-01M60	12033-01M01/02 12033-01M03/04 12033-01M10/12/13 12033-17M00/10 12033-61A00/01 12033-79Y00 12034-01M13 12034-61A01 12035-01M01/02/04 12035-01M12/13 12035-17M00 12035-61A00/01	
NISSAN E15S Bore Dia. 76.0 mm 4 cyl. 1,487 cc CHERRY SUNNY PRAIRIE B11 M10 N10 N12 (81-85) SOHC 8V	KBS15070	LB15070 length 138.0 outside diameter 80.0 flange diameter flange depth 11012-11M00 11012-11M20	KB15070 length 62.5 comp. height 32.5 -9.41 pin = 19.0 x 62.0 circlip not required	KR15070 top 1.5 2nd 1.5 oil 4.0 N-SWN30-057/114 SXN30-060 R-23021 / 23081 23140 / 23993 T-34053	
			12010-13M02 12010-13M04 12010-13M22 12010-13M23 12010-13M24	12033-01M01/02 12033-01M03/04 12033-01M10/12/13 12033-17M00/10 12033-61A00/01 12033-79Y00 12034-01M13 12034-61A01 12035-01M01/02/04 12035-01M12/13 12035-17M00 12035-61A00/01	
NISSAN E15-ET Bore Dia. 76.0 mm 4 cyl. 1,487 cc CHERRY N12 (82) SOHC 8V	KBS15080	LB15080 length 138.0 outside diameter 80.0 flange diameter flange depth 11012-11M00 11012-11M20	KB15080 length 61.0 comp. height 33.5 -10.0 pin = 19.0 x 62.0 circlip not required	KR15080 top 1.5 2nd 1.5 oil 4.0 N-SWN30-057/114 SXN30-060 R-23021 / 23081 23140 / 23993 T-34053	
			12010-17M02 12010-17M03 12010-17M04 12010-17M12	12033-01M01/02 12033-01M03/04 12033-01M10/12/13 12033-17M00/10 12033-61A00/01 12033-79Y00 12034-01M13 12034-61A01 12035-01M01/02/04 12035-01M12/13 12035-17M00 12035-61A00/01	

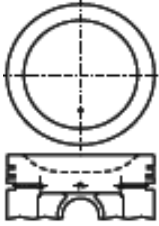
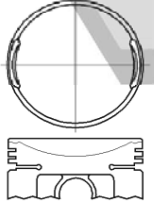
MOTOR - TYP	KOLBEN + RINGE PISTON + RINGS PISTONES + ANILLOS	LAUFBUCHSE CYL. SLEEVE CAMISAS	KOLBENSATZ PISTON SET PISTONES KIT	RINGSATZ RING SET ANILLOS	KOLBEN PISTON PISTONES
NISSAN E16S Bore Dia. 76.0 mm 4 cyl. 1,597 cc	KBS15090	LB15090 length 140.0 outside diameter 80.0 flange diameter flange depth	KB15090 length 62.9 comp. height 32.5 -10.0 pin = 19.0 x 63.0 circlip not required	KR15090 top 1.5 2nd 1.5 oil 4.0	
			12010-73A00 12010-73A22 12010-73A23 12010-73A24	N-SWN30-057/114 SXN30-060 R-23021 / 23081 23140 / 23993 T-34053 12033-01M01/02 12033-01M03/04 12033-01M10/12/13 12033-17M00/10 12033-61A00/01 12033-79Y00 12034-01M13 12034-61A01 12035-01M01/02/04 12035-01M12/13 12035-17M00 12035-61A00/01	
NISSAN GA16DE Bore Dia. 76.0 mm 4 cyl. 1,596 cc	KBS62000	LB62000 length 140.0 outside diameter 80.0 flange diameter flange depth	KB62000 length 54.0 comp. height 29.5 -4.8 pin = 19.0 x 52.0 circlip required	KR62000 top 1.5 2nd 1.5 oil 2.8	
SERENA C23M (92-99) DOHC 16V			12010-74Y00 12010-74Y01 12010-74Y02 12010-74Y08 12010-74Y09 A2010-74Y00 A2010-74Y01 A2010-74Y02 A2010-74Y08 A2010-74Y09	N-SWN30-097/104 R-23315 / 23998 T-34079 / 34082 12033-57Y00 12033-57Y01 12033-84A11 12033-94M00 12033-94M01 12033-94M02 12036-94M00 12036-94M01/02 12038-94M00 12038-94M01/02	
NISSAN GA16DE GA16DS Bore Dia. 76.0 mm 4 cyl. 1,596 cc	KBS62010	LB62010 length 140.0 outside diameter 80.0 flange diameter flange depth	KB62010 length 53.6 comp. height 29.5 -4.2 pin = 19.0 x 52.0 circlip required	KR62010 top 1.5 2nd 1.5 oil 2.8	
PRIMERA WAGON SUNNY SUNNY WAGON N14 W10 Y 10 (90-98) DOHC 16V			A2010-74Y10 A2010-74Y11 A2010-74Y12 A2010-74Y18 A2010-74Y19 A2010-62C10 A2010-62C11 A2010-62C12 A2010-62C18 A2010-62C19	N-SWN30-097/104 R-23315 / 23998 T-34079 / 34082 12033-57Y00 12033-57Y01 12033-84A11 12033-94M00 12033-94M01 12033-94M02 12036-94M00 12036-94M01/02 12038-94M00 12038-94M01/02	

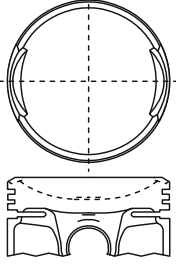
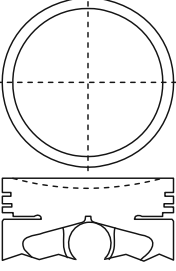
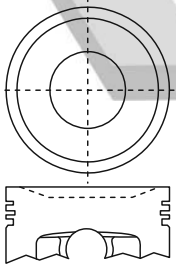
MOTOR - TYP	KOLBEN + RINGE PISTON + RINGS PISTONES + ANILLOS	LAUFBUCHSE CYL. SLEEVE CAMISAS	KOLBENSATZ PISTON SET PISTONES KIT	RINGSATZ RING SET ANILLOS	KOLBEN PISTON PISTONES
NISSAN GA16I Bore Dia. 76.0 mm 4 cyl. 1,596 cc	KBS62020	LB62020 length 140.0 outside diameter 80.0 flange diameter flange depth	KB62020 length 53.6 comp. height 29.5 -4.2 pin = 19.0 x 52.0 circlip required 12010-94M05 12010-94M06 12010-94M61 12010-94M62 12010-94M63	KR62020 top 1.5 2nd 1.5 oil 2.8 N-SWN30-097/104 R-23315/ 23998 T-34079/ 34082	
NISSAN E16I E16S Bore Dia. 76.0 mm 4 cyl. 1,597 cc	KBS62030	LB62030 length 140.0 outside diameter 80.0 flange diameter flange depth	KB62030 length 62.5 comp. height 32.5 -9.5 pin = 19.0 x 62.0 circlip not required 12010-31M02 12010-31M12 12010-33M22 12010-33M23 12010-33M24	KR62030 top 1.5 2nd 1.5 oil 4.0 N-SWN30-057/114 SXN30-060 R-23021/ 23081 23140 / 23993 T-34053	
NISSAN E15S Bore Dia. 76.0 mm 4 cyl. 1,487 cc	KBS62040	LB62040 length 138.0 outside diameter 80.0 flange diameter flange depth 11012-11M00 11012-11M20	KB62040 length 62.5 comp. height 32.5 -10.6 pin = 19.0 x 62.0 circlip not required 12010-11M02 12010-11M04 12010-11M12 12010-11M14 12010-11M22 12010-11M23 12010-11M24 12010-19M02 12010-19M22	KR62040 top 1.5 2nd 1.5 oil 4.0 N-SWN30-057/114 SXN30-060 R-23021/ 23081 23140 / 23993 T-34053	

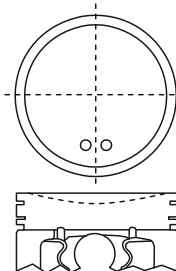
MOTOR - TYP	KOLBEN + RINGE PISTON + RINGS PISTONES + ANILLOS	LAUFBUCHSE CYL. SLEEVE CAMISAS	KOLBENSATZ PISTON SET PISTONES KIT	RINGSATZ RING SET ANILLOS	KOLBEN PISTON PISTONES
NISSAN E15S Bore Dia. 76.0 mm 4 cyl. 1,487 cc CHERRY SUNNY B11 N12 N13 (84-88) SOHC 8V	KBS62041	LB62041 length 138.0 outside diameter 80.0 flange diameter flange depth 11012-11M00 11012-11M20	KB62041 length 62.5 comp. height 32.5 -10.3 pin = 19.0 x 62.0 circlip not required	KR62041 top 1.5 2nd 1.5 oil 4.0 N-SWN30-057/114 SXN30-060 R-23021 / 23081 23140 / 23993 T-34053	
			12010-15M00 12010-15M02 12010-15M03 12010-15M04 12010-15M22 12010-15M24	12033-01M01/02 12033-01M03/04 12033-01M10/12/13 12033-17M00/10 12033-61A00/01 12033-79Y00 12034-01M13 12034-61A01 12035-01M01/02/04 12035-01M12/13 12035-17M00 12035-61A00/01	
NISSAN GA16DE GA16DS Bore Dia. 76.0 mm 4 cyl. 1,596 cc PRIMERA P10E (90-95) DOHC 16V	KBS62050	LB62050 length 140.0 outside diameter 80.0 flange diameter flange depth	KB62050 length 54.0 comp. height 29.5 -4.2 pin = 19.0 x 55.0 circlip required	KR62050 top 1.5 2nd 1.5 oil 3.0 N- R- T-	
			12010-71J00 12010-71J01 12010-71J02 12010-71J10 12010-71J11 12010-71J12 12010-71J13 12010-71J14 12010-71J15	12033-71J00 12033-71J01 12036-71J00 12036-71J01 12038-71J00 12038-71J01	
NISSAN QG16 Bore Dia. 76.0 mm 4 cyl. 1,597 cc PRIMERA DOHC 16V	KBS45501	LB45501 length 140.0 outside diameter 80.0 flange diameter flange depth	KB45501 length 53.7 comp. height 29.2 -4.8 pin = 19.0 x 52.0 circlip required	KR45501 top 1.5 2nd 1.5 oil 2.8 N-SWN30-097/104 R-23315 / 23998 T-34079 / 34082	
			12010-D4011 A2010-8M510	12033-57Y00 12033-57Y01 12033-84A11 12033-94M00 12033-94M01 12033-94M02 12036-94M00 12036-94M01/02 12038-94M00 12038-94M01/02	

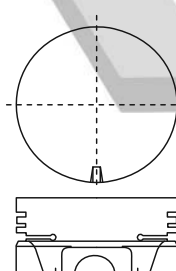
MOTOR - TYP	KOLBEN + RINGE PISTON + RINGS PISTONES + ANILLOS	LAUFBUCHSE CYL. SLEEVE CAMISAS	KOLBENSATZ PISTON SET PISTONES KIT	RINGSATZ RING SET ANILLOS	KOLBEN PISTON PISTONES
NISSAN QG16DE Bore Dia. 76.0 mm 4 cyl. 1,597 cc	KBS45500 head, top and 2nd ring lands anodized	LB45500 length 140.0 outside diameter 80.0 flange diameter flange depth	KB45500 length 53.5 comp. height 29.1 -5.0	KR45500 top 1.2 2nd 1.2 oil 2.5	
			pin = 19.0 x 52.0 circlip not required A2010-7J900 A2010-7J901 A2010-7J902 A2010-7J910 A2010-7J911 A2010-7J912 A2010-7J972 A2010-7J973 A2010-7J977 A2010-7J979	N- R-23080 T- 12033-7J900 12033-7J910 12036-7J900 12038-7J900	
PRIMERA P11E (00-01) DOHC 16V					
NISSAN A14 Bore Dia. 76.0 mm 4 cyl. 1,397 cc	KBS45510	LB45510 length 138.0 outside diameter 80.0 flange diameter flange depth 11012-H7200 11012-H7685 11012-H9700 11012-H9820	KB45510 length 67.4 comp. height 32.5 -4.2	KR45510 top 2.0 2nd 2.0 oil 4.0	
			pin = 19.0 x 63.0 circlip not required 12010-H7684	N-SWN30-045 R-23221 T-34606 12033-H7200 12033-H8660 12033-H8900 12033-H8910 12033-H8920 12033-H9910 12035-H7200 12035-H8910/20 12037-H7200 12037-H8910/20	
NISSAN J15 J16 Bore Dia. 78.0 mm 4 cyl. 1,483 1,567 cc	KBS45520	LB45520 length 140.0 outside diameter 82.0 flange diameter flange depth 11012-B5101 11012-B3000 11012-E3000	KB45520 length 79.3 comp. height 39.8 +0	KR45520 top 2.0 2nd 2.0 oil 4.0	
PICK UP 720 SERIES (79-81) SOHC 8V			pin = 21.0 x 66.5 circlip not required 12010-01W02 12010-01W04 12010-01W06 12010-01W12 12010-01W14 12010-01W16 12010-01W18 12010-E3001 12010-E3002 12010-E3004/06	N-SWN30-033 R-23210 T-34031 12033-01W60 12033-01W61 12033-01W62 12033-B3030 12033-B8200 12036-01W60 12036-01W62 12038-01W60 12038-01W62 12040-01W62	

2012 NEW

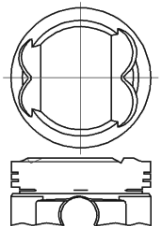
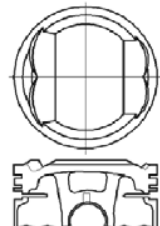
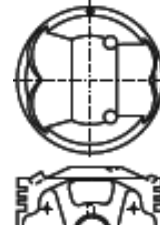

MOTOR - TYP	KOLBEN + RINGE PISTON + RINGS PISTONES + ANILLOS	LAUFBUCHSE CYL. SLEEVE CAMISAS	KOLBENSATZ PISTON SET PISTONES KIT	RINGSATZ RING SET ANILLOS	KOLBEN PISTON PISTONES
NISSAN GA16S Bore Dia. 78.0 mm 4 cyl. 1,598 cc	KBS45530	LB45530 length 140.0 outside diameter 82.0 flange diameter flange depth 11012-06E01	KB45530 length 66.7 comp. height 30.4 +1.7 pin = 20.0 x 61.0 circlip not required	KR45530 top 1.5 2nd 1.5 oil 4.0 N-SWN30-055 R-23180 T-34062	
			12010-06E01 12010-06E02 12010-06E03 12010-06E11 12010-06E12 12010-06E13 12010-D1101 12010-D1110 12010-D1111 12010-D1112/13	12033-06E00/1 12033-06E10 12033-D0120 12033-D0400 12036-06E00/10 12036-D0120 12036-D0400 12038-06E00/10 12038-D0120 12038-D0400	
NISSAN CA16S Bore Dia. 78.0 mm 4 cyl. 1,598 cc	KBS45540	LB45540 length 140.0 outside diameter 82.0 flange diameter flange depth 11012-06E01	KB45540 length 67.8 comp. height 30.0 +2.8 pin = 20.0 x 61.0 circlip not required	KR45540 top 1.5 2nd 1.5 oil 4.0 N-SWN30-055 R-23180 T-34062	
BLUEBIRD T12 (88) SOHC 8V			12010-D4001 12010-D4002 12010-D4003 12010-D4011 12010-D4012 12010-D4013	12033-06E00/1 12033-06E10 12033-D0120 12033-D0400 12036-06E00/10 12036-D0120 12036-D0400 12038-06E00/10 12038-D0120 12038-D0400	
NISSAN CA16S Bore Dia. 78.0 mm 4 cyl. 1,598 cc	KBS45541	LB45541 length 140.0 outside diameter 82.0 flange diameter flange depth 11012-06E01	KB45541 length 63.7 comp. height 30.0 +5.7 pin = 20.0 x 61.0 circlip not required	KR45541 top 1.5 2nd 1.5 oil 2.8 N-SWN30-111 R-23101/ 23220 T-	
BLUEBIRD T12 T72 (87-88) SOHC 8V			12010-56E12 12010-56E13 12010-56E14 12010-56E15 12010-56E62 12010-56E63	12033-55M00 12033-56E10 12033-64M00 12036-55M00 12036-56E10 12036-64M00 12038-55M00 12038-56E10 12038-64M00	

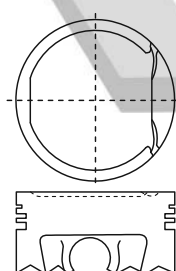

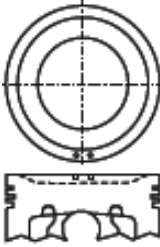
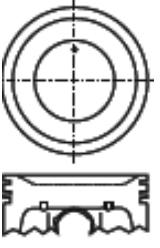
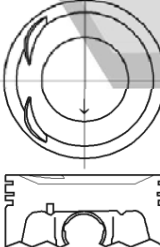
MOTOR - TYP	KOLBEN + RINGE PISTON + RINGS PISTONES + ANILLOS	LAUFBUCHSE CYL. SLEEVE CAMISAS	KOLBENSATZ PISTON SET PISTONES KIT	RINGSATZ RING SET ANILLOS	KOLBEN PISTON PISTONES
NISSAN HR16DE Bore Dia. 78.0 mm 4 cyl. 1,598 cc	KBS40500 top and 2nd ring lands anodized skirt MOS2 treated	LB40500 length 140.0 outside diameter 82.0 flange diameter flange depth	KB40500 length 46.8 comp. height 28.4 -4.7 pin = 19.0 x 53.5 circlip not required	KR40500 top 1.2 2nd 1.2 oil 2.0 N- R- T- 12010-ED500 12033-EE000	
	2012 NEW				
NISSAN HR16DE Bore Dia. 78.0 mm 4 cyl. 1,598 cc	KBS40501	LB40501 length 140.0 outside diameter 82.0 flange diameter flange depth	KB40501 length comp. height pin = x	KR40501 top 1.2 2nd 1.2 oil 2.0 N- R- T- 12010-BC200 12033-EE000	
	2012 NEW				
NISSAN K4M 752 Bore Dia. 79.5 mm 4 cyl. 1,598 cc	KBS40510 12000-00QAA 12000-00QAB 12000-00QAC	LB40510 length outside diameter flange diameter flange depth	KB40510 length 55.0 comp. height 31.7 -1.3 pin = 20.0 x 62.0 circlip not required	KR40510 top 1.5 2nd 1.5 oil 2.5 N- R- T- 12033-00QAB	

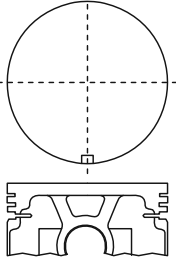
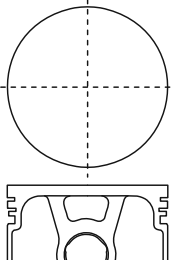
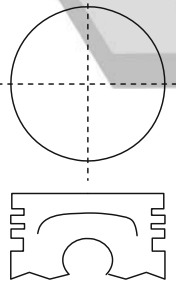
MOTOR - TYP	KOLBEN + RINGE PISTON + RINGS PISTONES + ANILLOS	LAUFBUCHSE CYL. SLEEVE CAMISAS	KOLBENSATZ PISTON SET PISTONES KIT	RINGSATZ RING SET ANILLOS	KOLBEN PISTON PISTONES	
NISSAN QG18 Bore Dia. 80.0 mm 4 cyl. 1,769 cc BLUEBIRD PULSAR N16 (02-04) DOHC 16V	KBS54002	LB54002 length outside diameter flange diameter flange depth	length 53.6 comp. height 29.2 -4.8	top 1.5 2nd 1.5 oil 2.8		
			pin = 19.0 x 52.0 circlip required	N-SWN30-127 R- T-		
			12010-WD301	12033-WD310		
NISSAN QG18DE Bore Dia. 80.0 mm 4 cyl. 1,769 cc ALMERA (TINO) PRIMERA (WAGON) N16 N16E P11E WP11E V10M (99-03) DOHC 16V	KBS54000	LB54000 length outside diameter flange diameter flange depth	length 53.7 comp. height 29.2 -5.0	top 1.2 2nd 1.2 oil 2.5		
			head, top and 2nd ring lands anodized skirt MOS2 treated	pin = 19.0 x 52.0 circlip required		N-SWN30-139/142 R-23340 T-34131
				12010-7J620 12010-7J621 12010-7J622 12010-7J625 12010-7J626 12010-7J627 12010-7J628 12010-7J629 12010-5M000/01 12010-5M002 A2010-5M010		12033-5M001/20 12033-7J600/01 12033-7J60A 12033-8M100 12033-AV300 12035-7J600/01 12035-7J60A 12036-7J600/01 12036-7J60A A2033-8M100
NISSAN QG18DE Bore Dia. 80.0 mm 4 cyl. 1,769 cc ALMERA ALMERA TINO PRIMERA N16E P12E V10M (01-05) DOHC 16V	KBS54001	LB54001 length outside diameter flange diameter flange depth	length 53.7 comp. height 29.2 -1.7 -4.7	top 1.2 2nd 1.2 oil 2.5		
			head, top and 2nd ring lands anodized skirt MOS2 treated	pin = 19.0 x 52.0 circlip required		N-SWN30-139/142 R-23340 T-34131
				12010-AU300 12010-AU301 12010-AU302 12014-AU300 12015-AU300 A2010-AU300 A2010-AU301 A2010-AU302 A2010-AU371/72 A2010-F4671		12033-5M001/20 12033-7J600/01 12033-7J60A 12033-8M100 12033-AV300 12035-7J600/01 12035-7J60A 12036-7J600/01 12036-7J60A A2033-8M100

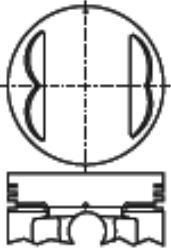
MOTOR - TYP	KOLBEN + RINGE PISTON + RINGS PISTONES + ANILLOS	LAUFBUCHSE CYL. SLEEVE CAMISAS	KOLBENSATZ PISTON SET PISTONES KIT	RINGSATZ RING SET ANILLOS	KOLBEN PISTON PISTONES
NISSAN J18 Bore Dia. 80.5 mm 4 cyl. 1,770 cc BLUEBIRD (76-) SOHC 8V	KBS54010	LB54010 length 152.4 outside diameter 84.7 flange diameter flange depth 12010-01W12	KB54010 length 65.5 comp. height 32.5 +0 pin = 21.0 x 66.5 circlip not required	KR54010 top 1.5 2nd 2.0 oil 4.0 N-SWN30-099 R-23701 T-34080 12033-24W00 12033-J2190 12033-J21G0 12033-N7900	
			12010-J22G0	12033-24W00 12033-J2190 12033-J21G0 12033-N7900	
NISSAN NA16 NA16S Bore Dia. 81.5 mm 4 cyl. 1,627 cc ATLAS CONDOR DATSUN TRUCK (94-) SOHC 8V	KBS54020	LB54020 length outside diameter flange diameter flange depth	KB54020 length 68.0 comp. height 35.9 +0 pin = 21.0 x 64.0 circlip not required	KR54020 top 1.5 2nd 1.5 oil 4.0 N- R- T-	
			12010-84G00 12010-84G72		
NISSAN SR18 SR18DI Bore Dia. 82.5 mm 4 cyl. 1,838 cc PRIMERA SUNNY DOHC	KBS54030	LB54030 length outside diameter flange diameter flange depth	KB54030 length 63.0 comp. height 32.0 +0 pin = 22.0 x 56.0 circlip required	KR54030 top 1.5 2nd 1.5 oil 3.0 N-SWN30-105/106 R-23251 T-	
			A2010-OE001	12033-64J00 12033-OE101 12035-OE101	

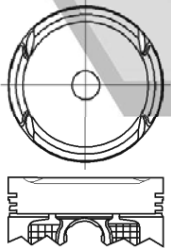
MOTOR - TYP	KOLBEN + RINGE PISTON + RINGS PISTONES + ANILLOS	LAUFBUCHSE CYL. SLEEVE CAMISAS	KOLBENSATZ PISTON SET PISTONES KIT	RINGSATZ RING SET ANILLOS	KOLBEN PISTON PISTONES
NISSAN CA18N Bore Dia. 82.7 mm 4 cyl. 1,796 cc BLUEBIRD (86-90) OHC	KBS54040	LB54040 length outside diameter flange diameter flange depth	length 65.0 comp. 30.0 height +0	top 1.5 2nd 1.5 oil 4.0	
			pin = 20.0 x 61.0 circlip not required	N- R- T-	
			12011-84600		
NISSAN CA18N Bore Dia. 82.7 mm 4 cyl. 1,796 cc BLUEBIRD (86-90) OHC	KBS54041	LB54041 length outside diameter flange diameter flange depth	length 65.0 comp. 30.0 height +0	top 1.5 2nd 1.5 oil 2.8	
			pin = 20.0 x 61.0 circlip not required	N- R-23371 T-	
				12033-64E10	
NISSAN F4R 720 Bore Dia. 82.7 mm 4 cyl. 1,998 cc PRIMASTER X83 (03-) DOHC 16V	KBS54050	LB54050 length outside diameter flange diameter flange depth	length 56.75 comp. 30.25 height -1.8 -2.6	top 1.2 2nd 1.5 oil 2.0	
			pin =21.0 x 61.0 circlip required	N- R- T-	
				12033-00QAC 12033-00QAD	

NISSAN

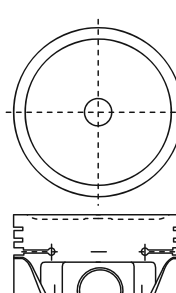
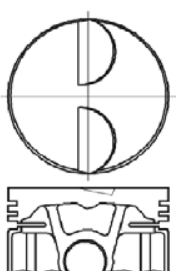
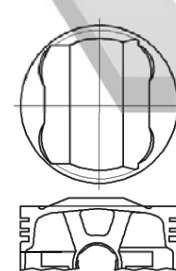
ENGINE MODEL	PISTON+RINGS	LAUFBUCHSE CYL. SLEEVE CAMISAS	KOLBENSATZ PISTON SET PISTONES KIT	RINGSATZ RING SET ANILLOS	KOLBEN PISTON PISTONES
NISSAN L16 Bore Dia. 83.0 mm 4 cyl. 1,595 cc DATSUN 510 (68-73) SOHC 8V	KBS54060	LB54060 length 140.0 outside diameter 87.0 flange diameter flange depth 11012-21000	KB54060 length 78.0 comp. height 38.0 -1.9 pin = 21.0 x 72.0 circlip not required 12010-23002 12010-23003 12010-23004 12010-23005 12010-23006 12010-23008 12010-E3101	KR54060 top 2.0 2nd 2.0 oil 4.0 N-SWN30-014 R-23031 / 23591 T-34023 12033-06/21/23000 12033-A0600 12033-A3500/01/02 12033-W0700 12033-W7100/10 12035-21/23000 12035-A3500 12036-21/23000 12036-A3500/01/02 12037-21/23000 12037-A3500 12038-21/23000 12038-A3500/01/02 12040-21/23000 12040-A3500	
			12010-H2711 12033-06/21/23000 12033-A0600 12033-A3500/01/02 12033-W0700 12033-W7100/10 12035-21/23000 12035-A3500 12036-21/23000 12036-A3500/01/02 12037-21/23000 12037-A3500 12038-21/23000 12038-A3500/01/02 12040-21/23000 12040-A3500		
NISSAN L14 L16 Bore Dia. 83.0 mm 4 cyl. 1,428 cc 1,595 cc BLUEBIRD DATSUN 510 STANZA VIOLET SOHC 12V	KBS54070	LB54070 length 140.0 outside diameter 87.0 flange diameter flange depth 11012-21000	KB54070 length 78.2 comp. height 38.7 -3.7 pin = 21.0 x 72.0 circlip required 12010-H2711	KR54070 top 2.0 2nd 2.0 oil 4.0 N-SWN30-014 R-23031 / 23591 T-34023 12033-06/21/23000 12033-A0600 12033-A3500/01/02 12033-W0700 12033-W7100/10 12035-21/23000 12035-A3500 12036-21/23000 12036-A3500/01/02 12037-21/23000 12037-A3500 12038-21/23000 12038-A3500/01/02 12040-21/23000 12040-A3500	
			12010-H2711 12033-06/21/23000 12033-A0600 12033-A3500/01/02 12033-W0700 12033-W7100/10 12035-21/23000 12035-A3500 12036-21/23000 12036-A3500/01/02 12037-21/23000 12037-A3500 12038-21/23000 12038-A3500/01/02 12040-21/23000 12040-A3500		
NISSAN CA18D Bore Dia. 83.0 mm 4 cyl. 1,809 cc SUNNY B12 N13 (88) DOHC 16V	KBS54080	LB54080 length 140.0 outside diameter 87.0 flange diameter flange depth 11012-DO300	KB54080 length 62.0 comp. height 30.0 +4.5 pin = 20.0 x 57.0 circlip required 12010-82A02 12010-82A03 12010-82A61 12010-82A62 12010-82A63 12010-82A64 12010-82A65	KR54080 top 1.5 2nd 1.5 oil 2.8 N-SWN30-077/090 R-23073 / 23521 T-34066 12033-17F00 12033-18F00/10 12033-44F00 12033-44F01/02 12033-59B00 12033-D4210 12036-18F00/10 12036-44F00/01/02 12038-18F00/10 12038-44F00/01/02	
			12010-82A02 12010-82A03 12010-82A61 12010-82A62 12010-82A63 12010-82A64 12010-82A65		

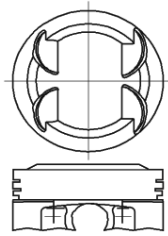
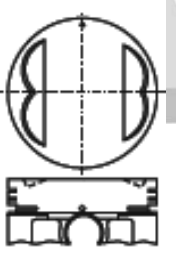

MOTOR - TYP	KOLBEN + RINGE PISTON + RINGS PISTONES + ANILLOS	LAUFBUCHSE CYL. SLEEVE CAMISAS	KOLBENSATZ PISTON SET PISTONES KIT	RINGSATZ RING SET ANILLOS	KOLBEN PISTON PISTONES
NISSAN CA18 Bore Dia. 83.0 mm 4 cyl. 1,809 cc BLUEBIRD	KBS54090	LB54090 length 140.0 outside diameter 87.0 flange diameter flange depth 11012-DO300	KB54090 length 60.3 comp. height 30.0 +2.3 pin = 20.0 x 57.0 circlip required	KR54090 top 1.5 2nd 1.5 oil 2.8 N-SWN30-077/090 R-23073 / 23521 T-34066 12033-17F00 12033-18F00/10 12033-44F00 12033-44F01/02 12033-59B00 12033-D4210 12036-18F00/10 12036-44F00/01/02 12038-18F00/10 12038-44F00/01/02	
NISSAN CA18ET CA18T Bore Dia. 83.0 mm 4 cyl. 1,809 cc BLUEBIRD SILVIA S12 T12 T72 U11 (84-88) SOHC 8V	KBS54110	LB54110 length 140.0 outside diameter 87.0 flange diameter flange depth 11012-DO300	KB54110 length 65.0 comp. height 30.0 +0 pin =20.0 x 61.0 circlip not required 12010-17F11 12010-17F12 12010-17F13	KR54110 top 1.5 2nd 1.5 oil 2.8 N-SWN30-077/090 R-23073 / 23521 T-34066 12033-17F00 12033-18F00/10 12033-44F00 12033-44F01/02 12033-59B00 12033-D4210 12036-18F00/10 12036-44F00/01/02 12038-18F00/10 12038-44F00/01/02	

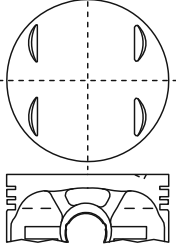
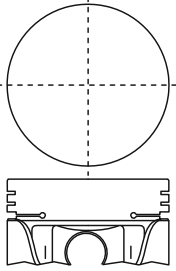
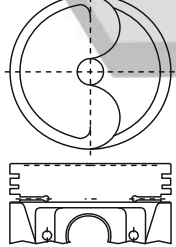
NISSAN

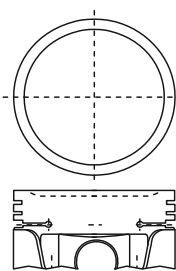
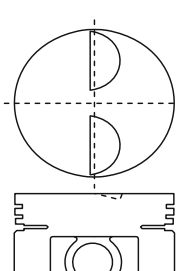
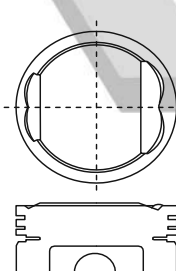
MOTOR - TYP	KOLBEN + RINGE PISTON + RINGS PISTONES + ANILLOS	LAUFBUCHSE CYL. SLEEVE CAMISAS	KOLBENSATZ PISTON SET PISTONES KIT	RINGSATZ RING SET ANILLOS	KOLBEN PISTON PISTONES
NISSAN CA18DT Bore Dia. 83.0 mm 4 cyl. 1,809 cc 200SX S13 (88) DOHC 16V	KBS24500 head anodized	LB24500 length 140.0 outside diameter 87.0 flange diameter flange depth 11012-DO300	KB24500 length 57.5 comp. height 30.0 +0 pin = 20.0 x 61.0 circlip required	KR24500 top 1.5 2nd 1.5 oil 2.8 N-SWN30-077/090 R-23073 / 23521 T-34066	
			12010-44F01 12010-44F02 12010-44F03 12010-44F61 12010-44F62 12010-44F63 12010-44F64 12010-44F65	12033-17F00 12033-18F00/10 12033-44F00 12033-44F01/02 12033-59B00 12033-D4210 12036-18F00/10 12036-44F00/01/02 12038-18F00/10 12038-44F00/01/02	
NISSAN L13 Bore Dia. 83.0 mm 4 cyl. 1,296 cc BLUEBIRD DATSUN 510 SOHC 8V	KBS54130	LB54130 length 140.0 outside diameter 87.0 flange diameter flange depth 11012-21000	KB54130 length 78.0 comp. height 38.0 +0 pin = 21.0 x 72.0 circlip not required	KR54130 top 2.0 2nd 2.0 oil 4.0 N-SWN30-014 R-23031 / 23591 T-34023	
			12010-22001 12010-22003 12010-22004 12010-22005 12010-22006 12010-22008 12010-22101	12033-06/21/23000 12033-A0600 12033-A3500/01/02 12033-W0700 12033-W7100/10 12035-21/23000 12035-A3500 12036-21/23000 12036-A3500/01/02 12037-21/23000 12037-A3500 12038-21/23000 12038-A3500/01/02 12040-21/23000 12040-A3500	
NISSAN L14 Bore Dia. 83.0 mm 4 cyl. 1,428 cc BLUEBIRD STANZA VIOLET A10 SOHC 8V	KBS54140	LB54140 length 140.0 outside diameter 87.0 flange diameter flange depth 11012-21000	KB54140 length 78.0 comp. height 38.0 -0.8 pin = 21.0 x 72.0 circlip not required	KR54140 top 2.0 2nd 2.0 oil 4.0 N-SWN30-014 R-23031 / 23591 T-34023	
			12010-H2501 12010-H2511 12010-H2512	12033-06/21/23000 12033-A0600 12033-A3500/01/02 12033-W0700 12033-W7100/10 12035-21/23000 12035-A3500 12036-21/23000 12036-A3500/01/02 12037-21/23000 12037-A3500 12038-21/23000 12038-A3500/01/02 12040-21/23000 12040-A3500	

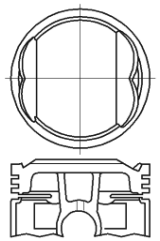
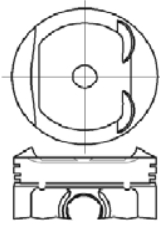
MOTOR - TYP	KOLBEN + RINGE PISTON + RINGS PISTONES + ANILLOS	LAUFBUCHSE CYL. SLEEVE CAMISAS	KOLBENSATZ PISTON SET PISTONES KIT	RINGSATZ RING SET ANILLOS	KOLBEN PISTON PISTONES
NISSAN L16S Bore Dia. 83.0 mm 4 cyl. 1,595 cc	KBS54150	LB54150 length 140.0 outside diameter 87.0 flange diameter flange depth 11012-21000	KB54150 length 78.0 comp. height 38.0 -1.2 pin = 21.0 x 72.0 circlip not required	KR54150 top 2.0 2nd 2.0 oil 4.0 N-SWN30-014 R-23031 / 23591 T-34023	
			12010-A9600 12010-A9601 12010-A9604 12010-A9606 12010-A9611 12010-A9614 12010-A9616	12033-06/21/23000 12033-A0600 12033-A3500/01/02 12033-W0700 12033-W7100/10 12035-21/23000 12035-A3500 12036-21/23000 12036-A3500/01/02 12037-21/23000 12037-A3500 12038-21/23000 12038-A3500/01/02 12040-21/23000 12040-A3500	
BLUEBIRD 910 SERIES (80) SOHC 8V					
NISSAN Z16T Bore Dia. 83.0 mm 4 cyl. 1,595 cc	KBS54160	LB54160 length 140.0 outside diameter 87.0 flange diameter flange depth 11012-21000	KB54160 length 78.0 comp. height 38.0 -2.9 pin = 21.0 x 72.0 circlip not required	KR54160 top 2.0 2nd 2.0 oil 4.0 N-SWN30-014 R-23031 / 23591 T-34023	
			12010-A8601 12010-A8602 12010-A8612	12033-06/21/23000 12033-A0600 12033-A3500/01/02 12033-W0700 12033-W7100/10 12035-21/23000 12035-A3500 12036-21/23000 12036-A3500/01/02 12037-21/23000 12037-A3500 12038-21/23000 12038-A3500/01/02 12040-21/23000 12040-A3500	
DATSUN 510 (68-72) SOHC 8V					
NISSAN Z16 Bore Dia. 83.0 mm 4 cyl. 1,595 cc	KBS54170	LB54170 length 140.0 outside diameter 87.0 flange diameter flange depth 11012-21000	KB54170 length 78.9 comp. height 38.0 +0.6 pin = 21.0 x 66.0 circlip not required	KR54170 top 2.0 2nd 2.0 oil 4.0 N-SWN30-014 R-23031 / 23591 T-34023	
			12010-W7111 12010-W7121	12033-06/21/23000 12033-A0600 12033-A3500/01/02 12033-W0700 12033-W7100/10 12035-21/23000 12035-A3500 12036-21/23000 12036-A3500/01/02 12037-21/23000 12037-A3500 12038-21/23000 12038-A3500/01/02 12040-21/23000 12040-A3500	
NAVARA D21 SOHC 8V					

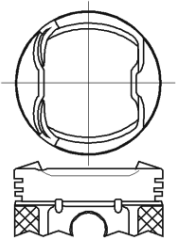
MOTOR - TYP	KOLBEN + RINGE PISTON + RINGS PISTONES + ANILLOS	LAUFBUCHSE CYL. SLEEVE CAMISAS	KOLBENSATZ PISTON SET PISTONES KIT	RINGSATZ RING SET ANILLOS	KOLBEN PISTON PISTONES
NISSAN Z16 Bore Dia. 83.0 mm 4 cyl. 1,595 cc	KBS54171	LB54171 length 140.0 outside diameter 87.0 flange diameter flange depth 11012-21000	KB54171 length 78.8 comp. height 38.2 +0.6 pin = 21.0 x 64.0 circlip not required 12010-W7161	KR54171 top 2.0 2nd 2.0 oil 4.0 N-SWN30-014 R-23031 / 23591 T-34023 12033-06/21/23000 12033-A0600 12033-A3500/01/02 12033-W0700 12033-W7100/10 12035-21/23000 12035-A3500 12036-21/23000 12036-A3500/01/02 12037-21/23000 12037-A3500 12038-21/23000 12038-A3500/01/02 12040-21/23000 12040-A3500	
NISSAN MR18DE Bore Dia. 84.0 mm 4 cyl. 1,798 cc	KBS41500 head, top and 2nd ring lands anodized skirt MOS2 treated	LB41500 length outside diameter flange diameter flange depth	KB41500 length 49.6 comp. height 31.1 -1.9 -3.6 pin = 20.0 x 53.0 circlip required A2010-ED800 A2010-ED801	KR41500 top 1.2 2nd 1.2 oil 2.0 N- R- T- 12033-EN200 12033-EN20A	
NISSAN MR20DE Bore Dia. 84.0 mm 4 cyl. 1,997 cc	KBS18500	LB18500 length outside diameter flange diameter flange depth	KB18500 length comp. height pin = x A2010-CK80A A2010-CK81A	KR18500 top 2nd oil N- R- T- 12033-CK80A A2033-CK80A	

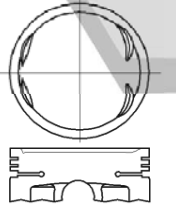

MOTOR - TYP	KOLBEN + RINGE PISTON + RINGS PISTONES + ANILLOS	LAUFBUCHSE CYL. SLEEVE CAMISAS	KOLBENSATZ PISTON SET PISTONES KIT	RINGSATZ RING SET ANILLOS	KOLBEN PISTON PISTONES
NISSAN MR20DE Bore Dia. 84.0 mm 4 cyl. 1,997 cc	KBS18501 head, top and 2nd ring lands anodized skirt MOS2 treated	LB18501 length outside diameter flange diameter flange depth	KB18501 length 49.7 comp. height 31.2 +3.1 -4.8	KR18501 top 1.2 2nd 1.2 oil 2.0	
			pin = 20.0 x 53.0 circlip required 12010-ET000 A2010-ET000 A2010-ET001	N- R- T- 12033-EN200 12033-EN20A	
NISSAN CA20 CA20S Bore Dia. 84.5 mm 4 cyl. 1,974 cc	KBS94500	LB94500 length 150.0 outside diameter 88.5 flange diameter flange depth 11012-04FOO	KB94500 length 65.0 comp. height 30.0 -1.9	KR94500 top 1.5 2nd 1.5 oil 4.0	
BLUEBIRD SOHC 8V			pin = 20.0 x 61.0 circlip not required 12010-D1800 12010-D1801 12011-D1800 12011-D1801	N-SWN30-053/063 R-23420/ 23430 T-34056 12033-04E00/10 12033-D1700 12033-D20/D3600 12033-D4700/10 12036-04E00/10 12036-D20/D3600 12036-D4700/10 12038-04E10 12038-D20/D3600 12038-D4700/10	
NISSAN CA20S Bore Dia. 84.5 mm 4 cyl. 1,974 cc	KBS94510	LB94510 length 150.0 outside diameter 88.5 flange diameter flange depth 11012-04FOO	KB94510 length 64.9 comp. height 30.1 -2.3	KR94510 top 1.5 2nd 1.5 oil 4.0	
BLUEBIRD T12 U11 (84-88) SOHC 8V			pin = 20.0 x 61.0 circlip not required 12010-04E00 12010-04E01 12010-04E02 12010-04E03 12010-04E11 12010-04E12 12010-04E13 12010-04F01 12010-04F11 12010-10F01/11	N-SWN30-053/063 R-23420/ 23430 T-34056 12033-04E00/10 12033-D1700 12033-D20/D3600 12033-D4700/10 12036-04E00/10 12036-D20/D3600 12036-D4700/10 12038-04E10 12038-D20/D3600 12038-D4700/10	

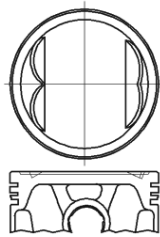
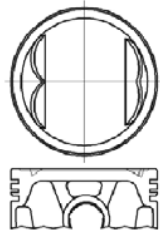
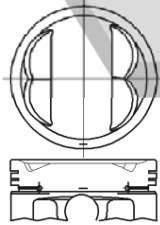

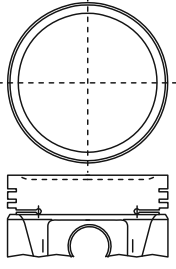
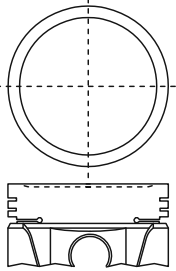
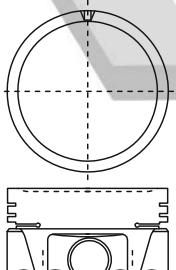
MOTOR - TYP	KOLBEN + RINGE PISTON + RINGS PISTONES + ANILLOS	LAUFBUCHSE CYL. SLEEVE CAMISAS	KOLBENSATZ PISTON SET PISTONES KIT	RINGSATZ RING SET ANILLOS	KOLBEN PISTON PISTONES
NISSAN CA20S CA20E Bore Dia. 84.5 mm 4 cyl. 1,974 cc BLUEBIRD LAUREL PRAIRIE C32 M10 M11 T12 T72 U11 (84-92) SOHC 8V	KBS94520	LB94520 length 150.0 outside diameter 88.5 flange diameter flange depth 11012-04FOO	KB94520 length 65.0 comp. height 30.0 -0.2 -2.6 pin = 20.0 x 61.0 circlip not required	KR94520 top 1.5 2nd 1.5 oil 2.8 N-SWN30-121 R-23381 / 23382 23990 T-34086	
			12010-13E11 12010-13E12 12010-13E13 12010-13E14 12010-13E15 12010-13E16 12010-13E17 12010-13E18	12033-13E00 12033-35R00 12033-61E00 12033-61E10 12036-13E00 12036-61E10 12038-13E00 12038-61E10	
NISSAN CA20 Bore Dia. 84.5 mm 4 cyl. 1,974 cc BLUEBIRD SOHC 8V	KBS94530	LB94530 length 150.0 outside diameter 88.5 flange diameter flange depth 11012-04FOO	KB94530 length 65.0 comp. height 30.0 -0.2 -2.6 pin = 20.0 x 61.0 circlip not required	KR94530 top 1.5 2nd 1.5 oil 4.0 N-SWN30-053/063 R-23420 / 23430 T-34056	
			12033-04E00/10 12033-D1700 12033-D20/D3600 12033-D4700/10 12036-04E00/10 12036-D20/D3600 12036-D4700/10 12038-04E10 12038-D20/D3600 12038-D4700/10		
NISSAN CA20E Bore Dia. 84.5 mm 4 cyl. 1,974 cc BLUEBIRD PRAIRIE M11 T12 T72 U11 (88-92) SOHC 8V	KBS94540	LB94540 length 150.0 outside diameter 88.5 flange diameter flange depth 11012-04FOO	KB94540 length 65.0 comp. height 30.0 -1.5 pin = 20.0 x 61.0 circlip not required	KR94540 top 1.5 2nd 1.5 oil 4.0 N-SWN30-053/063 R-23420 / 23430 T-34056	
			12010-D3601 12010-D3602 12010-D3603 12010-D3604 12010-D3605 12010-D3612 12010-D3613 12010-D5501	12033-04E00/10 12033-D1700 12033-D20/D3600 12033-D4700/10 12036-04E00/10 12036-D20/D3600 12036-D4700/10 12038-04E10 12038-D20/D3600 12038-D4700/10	

MOTOR - TYP	KOLBEN + RINGE PISTON + RINGS PISTONES + ANILLOS	LAUFBUCHSE CYL. SLEEVE CAMISAS	KOLBENSATZ PISTON SET PISTONES KIT	RINGSATZ RING SET ANILLOS	KOLBEN PISTON PISTONES
NISSAN L18 / L18E L18S / L18T Bore Dia. 85.0 mm 4 cyl. 1,770 cc BLUEBIRD PICK UP SILVIA 720 SERIES 910 SERIES S110 SERIES (80-81) SOHC 8V	KBS94550	LB94550 length 150.0 outside diameter 89.0 flange diameter flange depth 11012-A8701 11012-U2000	KB94550 length 78.1 comp. height 38.1 -2.25 pin = 21.0 x 72.0 circlip not required	KR94550 top 2.0 2nd 2.0 oil 4.0	
			12010-A8711 12010-A8714 12010-A8716 12010-W0801 12010-W0804 12010-W0806 12010-W0811 12010-W0812 12010-W0813	N-SWN30-020 N-SWN30-048/050 R-23131 / 23581 23601 / 23605 T-34028 12033-78520/21 12033-A8701/02/13 12033-N9700 12033-U6000/01/02 12033-W0805/15 12033-W1510 12033-W1600 12036-A8702/13 12036-W0805 12038-A8702/13 12038-W0805	
NISSAN L18 Bore Dia. 85.0 mm 4 cyl. 1,770 cc BLUEBIRD SKYLINE SOHC 8V	KBS94560	LB94560 length 150.0 outside diameter 89.0 flange diameter flange depth 11012-A8701 11012-U2000	KB94560 length 78.1 comp. height 38.1 -0.7 pin = 21.0 x 72.0 circlip not required	KR94560 top 2.0 2nd 2.0 oil 4.0	
			12010-A8700 12010-A8701 12010-U2000	N-SWN30-020 N-SWN30-048/050 R-23131 / 23581 23601 / 23605 T-34028 12033-78520/21 12033-A8701/02/13 12033-N9700 12033-U6000/01/02 12033-W0805/15 12033-W1510 12033-W1600 12036-A8702/13 12036-W0805 12038-A8702/13 12038-W0805	
NISSAN L18 Bore Dia. 85.0 mm 4 cyl. 1,770 cc BLUEBIRD SKYLINE SOHC 8V	KBS94561	LB94561 length 150.0 outside diameter 89.0 flange diameter flange depth 11012-A8701 11012-U2000	KB94561 length 78.1 comp. height 38.1 -1.0 pin = 21.0 x 72.0 circlip not required	KR94561 top 2.0 2nd 2.0 oil 4.0	
			12010-U2021	N-SWN30-020 N-SWN30-048/050 R-23131 / 23581 23601 / 23605 T-34028 12033-78520/21 12033-A8701/02/13 12033-N9700 12033-U6000/01/02 12033-W0805/15 12033-W1510 12033-W1600 12036-A8702/13 12036-W0805 12038-A8702/13 12038-W0805	

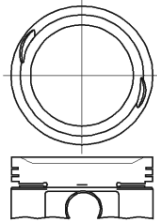
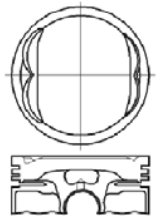
NISSAN

MOTOR - TYP	KOLBEN + RINGE PISTON + RINGS PISTONES + ANILLOS	LAUFBUCHSE CYL. SLEEVE CAMISAS	KOLBENSATZ PISTON SET PISTONES KIT	RINGSATZ RING SET ANILLOS	KOLBEN PISTON PISTONES
NISSAN Z20 Z20S Bore Dia. 85.0 mm 4 cyl. 1,952 cc CABSTAR KINGCAB URVAN VANETTE D21 E23 E24 F22 GC22 (82-94) SOHC 8V	KBS94570	LB94570 length 150.0 outside diameter 89.0 flange diameter flange depth 11012-W1411 11012-U6000	KB94570 length 67.0 comp. height 32.0 -3.6 pin = 21.0 x 72.7 circlip not required 12010-W1411 12010-W1412 12010-W1413 12010-W1421 12010-W1422 12010-W1423 12010-W1461 12010-W1462 12010-W1463	KR94570 top 1.5 2nd 1.5 oil 4.0 N-SWN30-061/086 R-23272 / 23461 T-34042 12033-24G00/10/20 12033-N8510 12033-N8520 12033-R9400 12036-24G00/10/20 12036-N8520 12036-R9400 12038-24G00/10/20 12038-N8520 12038-R9400	
NISSAN Z20E Bore Dia. 85.0 mm 4 cyl. 1,952 cc BLUEBIRD 910 SERIES (82) SOHC 8V	KBS94580	LB94580 length 150.0 outside diameter 89.0 flange diameter flange depth 11012-W1411 11012-U6000	KB94580 length 67.0 comp. height 32.0 -1.6 pin = 21.0 x 72.0 circlip not required 12010-82W01 12010-82W03 12010-W4001 12010-W4002 12010-W4003	KR94580 top 1.5 2nd 1.5 oil 4.0 N-SWN30-061/086 R-23272 / 23461 T-34042 12033-24G00/10/20 12033-N8510 12033-N8520 12033-R9400 12036-24G00/10/20 12036-N8520 12036-R9400 12038-24G00/10/20 12038-N8520 12038-R9400	
NISSAN Z20 Z20E Bore Dia. 85.0 mm 4 cyl. 1,952 cc CARAVAN LAUREL VANETTE SOHC 8V	KBS94590	LB94590 length 150.0 outside diameter 89.0 flange diameter flange depth 11012-W1411 11012-U6000	KB94590 length 66.9 comp. height 32.0 +0 pin = 21.0 x 72.0 circlip not required 12010-N8501 12010-N8511 12010-N8521 12010-N8701	KR94590 top 1.5 2nd 1.5 oil 4.0 N-SWN30-061/086 R-23272 / 23461 T-34042 12033-24G00/10/20 12033-N8510 12033-N8520 12033-R9400 12036-24G00/10/20 12036-N8520 12036-R9400 12038-24G00/10/20 12038-N8520 12038-R9400	

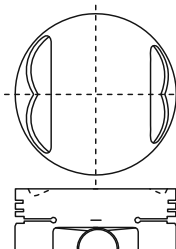
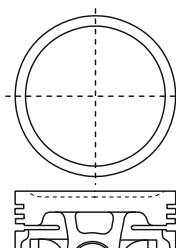
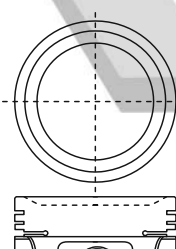
MOTOR - TYP	KOLBEN + RINGE PISTON + RINGS PISTONES + ANILLOS	LAUFBUCHSE CYL. SLEEVE CAMISAS	KOLBENSATZ PISTON SET PISTONES KIT	RINGSATZ RING SET ANILLOS	KOLBEN PISTON PISTONES
NISSAN Z20 Z20S Bore Dia. 85.0 mm 4 cyl. 1,952 cc CARAVAN LAUREL VANETTE SOHC 8V	KBS94600	LB94600 length 150.0 outside diameter 89.0 flange diameter flange depth 11012-W1411 11012-U6000	KB94600 length 67.0 comp. height 32.1 +0 pin = 21.0 x 71.4 circlip not required	KR94600 top 1.5 2nd 1.5 oil 4.0 N-SWN30-061/086 R-23272/ 23461 T-34042 12033-24G00/10/20 12033-N8510 12033-N8520 12033-R9400 12036-24G00/10/20 12036-N8520 12036-R9400 12038-24G00/10/20 12038-N8520 12038-R9400	
			pin = 21.0 x 72.0 circlip not required	N-SWN30-020 N-SWN30-048/050 R-23131/ 23581 23601 / 23605 T-34028 12033-78520/21 12033-A8701/02/13 12033-N9700 12033-U6000/01/02 12033-W0805/15 12033-W1510 12033-W1600 12036-A8702/13 12036-W0805 12038-A8702/13 12038-W0805	
			12010-U6001 12010-U6011 12010-U6021	12033-78520/21 12033-A8701/02/13 12033-N9700 12033-U6000/01/02 12033-W0805/15 12033-W1510 12033-W1600 12036-A8702/13 12036-W0805 12038-A8702/13 12038-W0805	
NISSAN L20B Bore Dia. 85.0 mm 4 cyl. 1,998 cc CEDRIL LAUREL SKYLINE SOHC 8V	KBS94610	LB94610 length outside diameter flange diameter flange depth	KB94610 length 78.3 comp. height 38.1 -3.0 pin = 21.0 x 72.0 circlip not required	KR94610 top 2.0 2nd 2.0 oil 4.0 N-SWN30-020 N-SWN30-048/050 R-23131/ 23581 23601 / 23605 T-34028 12033-78520/21 12033-A8701/02/13 12033-N9700 12033-U6000/01/02 12033-W0805/15 12033-W1510 12033-W1600 12036-A8702/13 12036-W0805 12038-A8702/13 12038-W0805	
			pin = 21.0 x 72.0 circlip not required	N-SWN30-020 N-SWN30-048/050 R-23131/ 23581 23601 / 23605 T-34028 12033-78520/21 12033-A8701/02/13 12033-N9700 12033-U6000/01/02 12033-W0805/15 12033-W1510 12033-W1600 12036-A8702/13 12036-W0805 12038-A8702/13 12038-W0805	
			12010-U6001 12010-U6011 12010-U6021	12033-78520/21 12033-A8701/02/13 12033-N9700 12033-U6000/01/02 12033-W0805/15 12033-W1510 12033-W1600 12036-A8702/13 12036-W0805 12038-A8702/13 12038-W0805	
NISSAN L20B Bore Dia. 85.0 mm 4 cyl. 1,998 cc CEDRIL LAUREL SKYLINE SOHC 8V	KBS94611	LB94611 length outside diameter flange diameter flange depth	KB94611 length 78.1 comp. height 38.1 -4.0 pin = 21.0 x 72.0 circlip not required	KR94611 top 2.0 2nd 2.0 oil 4.0 N-SWN30-020 N-SWN30-048/050 R-23131/ 23581 23601 / 23605 T-34028 12033-78520/21 12033-A8701/02/13 12033-N9700 12033-U6000/01/02 12033-W0805/15 12033-W1510 12033-W1600 12036-A8702/13 12036-W0805 12038-A8702/13 12038-W0805	
			pin = 21.0 x 72.0 circlip not required	N-SWN30-020 N-SWN30-048/050 R-23131/ 23581 23601 / 23605 T-34028 12033-78520/21 12033-A8701/02/13 12033-N9700 12033-U6000/01/02 12033-W0805/15 12033-W1510 12033-W1600 12036-A8702/13 12036-W0805 12038-A8702/13 12038-W0805	
			12010-O4W01 12010-O4W11	12033-78520/21 12033-A8701/02/13 12033-N9700 12033-U6000/01/02 12033-W0805/15 12033-W1510 12033-W1600 12036-A8702/13 12036-W0805 12038-A8702/13 12038-W0805	

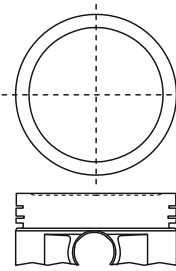
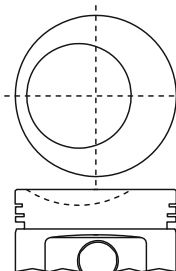
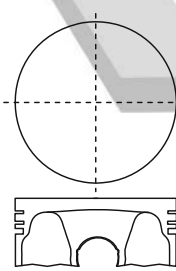
MOTOR - TYP	KOLBEN + RINGE PISTON + RINGS PISTONES + ANILLOS	LAUFBUCHSE CYL. SLEEVE CAMISAS	KOLBENSATZ PISTON SET PISTONES KIT	RINGSATZ RING SET ANILLOS	KOLBEN PISTON PISTONES
NISSAN SR20DE Bore Dia. 86.0 mm 4 cyl. 1,998 cc	KBS27000	length outside diameter flange diameter flange depth	length 63.0 comp. 32.0 height -0.8	top 1.5 2nd 1.5 oil 3.0	
			pin = 22.0 x 60.0 circlip required 12010-63J00 12010-63J01 12010-63J02 12010-63J71 12011-65J00 A2010-63J00 A2010-63J01 A2010-63J02 A2010-63J71	N-SWN30-102/109 R-23695 T-34085 12033-53J00/01 12033-53J10/20 12033-53T00 12033-60J20/21 12033-60J22/62 12035-53J00/01 12035-53J10/20 12035-60J20/21 12035-60J22/62	
SERENA C23M (92-94) DOHC 16V	KBS94620	length outside diameter flange diameter flange depth	length 70.0 comp. 38.45 height -8.5	top 1.5 2nd 1.5 oil 4.0	
CABSTAR F23 (92-94) SOHC 8V			pin = 21.0 x 64.0 circlip not required 12010-85G00 12010-85G01 12010-85G02 12010-85G72 12010-85G73	N-SWN30-159 R-23501 T-34111 12033-3T600 12033-85G00 12036-3T602 12036-3T604	
NISSAN SR20DE Bore Dia. 86.0 mm 4 cyl. 1,998 cc	KBS27001	length outside diameter flange diameter flange depth	length 63.0 comp. 32.0 height +0	top 1.5 2nd 1.5 oil 3.0	
			pin = 22.0 x 60.0 circlip required A2010-65J00 A2010-65J01 A2010-65J02 A2010-65J71	N-SWN30-102/109 R-23695 T-34085 12033-53J00/01 12033-53J10/20 12033-53T00 12033-60J20/21 12033-60J22/62 12035-53J00/01 12035-53J10/20 12035-60J20/21 12035-60J22/62	

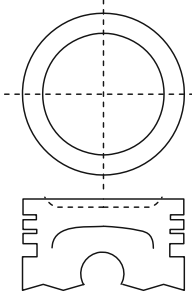
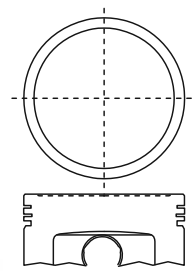
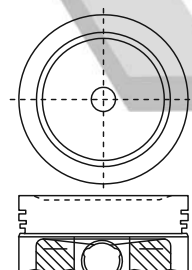
MOTOR - TYP	KOLBEN + RINGE PISTON + RINGS PISTONES + ANILLOS	LAUFBUCHSE CYL. SLEEVE CAMISAS	KOLBENSATZ PISTON SET PISTONES KIT	RINGSATZ RING SET ANILLOS	KOLBEN PISTON PISTONES
NISSAN SR20DET Bore Dia. 86.0 mm 4 cyl. 1,998 cc 200SX SUNNY N14 S14 (90-92) DOHC 16V	KBS27003	LB27003	length 59.5	top 1.5	
			outside diameter 32.0	2nd 1.5	
NISSAN KA20 Bore Dia. 86.0 mm 4 cyl. 1,990 cc NAVARA PICK UP (99)	KBS94640	LB94640	length 70.2	top 1.5	
			outside diameter 38.5	2nd 1.5	
NISSAN SR20DE Bore Dia. 86.0 mm 4 cyl. 1,998 cc SENTRA DOHC	KBS27002	LB27002	length 58.1	top 1.2	
			outside diameter 32.0	2nd 1.2	
2012 NEW					

NISSAN

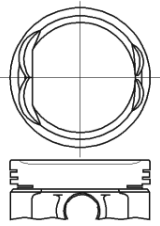
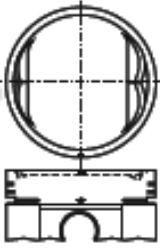
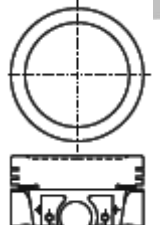
MOTOR - TYP	KOLBEN + RINGE PISTON + RINGS PISTONES + ANILLOS	LAUFBUCHSE CYL. SLEEVE CAMISAS	KOLBENSATZ PISTON SET PISTONES KIT	RINGSATZ RING SET ANILLOS	KOLBEN PISTON PISTONES
NISSAN Z22 Bore Dia. 87.0 mm 4 cyl. 2,187 cc PICK UP 720 SERIES (83) SOHC 8V	KBS94650	LB94650 length 150.0 outside diameter 91.0 flange diameter flange depth 11012-D1801	length 67.0 comp. height 31.9 -2.3 pin = 21.0 x 64.0 circlip not required	top 1.5 2nd 1.5 oil 4.0 N-SWN30-054 R-23301 / 23492 T-34050	
			12010-D8101 12010-D8102 12010-D8103 12010-D8111 12010-D8112 12010-D8113	12033-06W10 12033-06W20 12033-D8500 12033-T8300 12033-T8301 12036-06W20 12036-T8300 12036-T8301 12038-06W20 12038-T8300/01	
NISSAN Z22 Z22E Bore Dia. 87.0 mm 4 cyl. 2,187 cc CABSTER (81-83) SOHC 8V	KBS94660	LB94660 length 150.0 outside diameter 91.0 flange diameter flange depth 11012-D1801	length 71.8 comp. height 35.5 -2.3 pin = 21.0 x 72.0 circlip not required	top 1.5 2nd 1.5 oil 4.0 N-SWN30-054 R-23301 / 23492 T-34050	
			12010-06W11 12010-06W21	12033-06W10 12033-06W20 12033-D8500 12033-T8300 12033-T8301 12036-06W20 12036-T8300 12036-T8301 12038-06W20 12038-T8300/01	
NISSAN H20 Bore Dia. 87.2 mm 4 cyl. 1,982 cc URVAN E23 (80-82) SOHC 8V	KBS94670	LB94670 length 150.0 outside diameter 91.2 flange diameter flange depth	length 84.0 comp. height 41.0 -1.65 pin = 22.0 x 72.5 circlip required	top 2.0 2nd 2.5 oil 4.0 N-SWN30-023/069 R-23141 T-34017	
			12010-74001 12010-74004 12010-74006 12010-R9001 12010-R9004 12010-R9006	12033-14601 12033-50K00 12033-R9000/23 12033-Y4460 12035-50K00 12036-50K00 12036-R9000/23 12036-Y4460 12037-50K00 12038-R9000/23 12038-Y4460 12040-R9000	

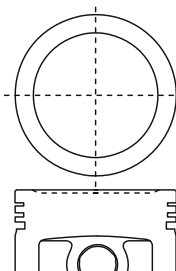
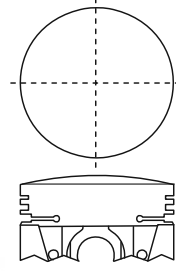
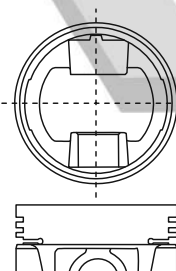
MOTOR - TYP	KOLBEN + RINGE PISTON + RINGS PISTONES + ANILLOS	LAUFBUCHSE CYL. SLEEVE CAMISAS	KOLBENSATZ PISTON SET PISTONES KIT	RINGSATZ RING SET ANILLOS	KOLBEN PISTON PISTONES
NISSAN H20 II Bore Dia. 87.2 mm 4 cyl. 1,982 cc FORKLIFT D01S J01 J01S J02 (93-00) SOHC 8V	KBS94680	LB94680 length 150.0 outside diameter 91.2 flange diameter flange depth	KB94680 length 71.0 comp. height 41.0 -1.6 pin = 20.0 x 62.0 circlip not required	KR94680 top 2.0 2nd 2.5 oil 4.0 N-SWN30-023/069 R-23141 T-34017	
			12010-50K00 12010-50K24 12010-50K70 12010-50K71 12010-50K72 12010-50K73	12033-14601 12033-50K00 12033-R9000/23 12033-Y4460 12035-50K00 12036-50K00 12036-R9000/23 12036-Y4460 12037-50K00 12038-R9000/23 12038-Y4460 12040-R9000	
NISSAN R Bore Dia. 87.2 mm 4 cyl. 1,595 cc	KBS94690	LB94690 length outside diameter flange diameter flange depth	KB94690 length 88.1 comp. height 41.0 +4.1 pin = 22.0 x 73.0 circlip required	KR94690 top 2.0 2nd 2.5 oil 4.0 N-SWN30-023/069 R-23141 T-34017	
			12010-14611	12033-14601 12033-50K00 12033-R9000/23 12033-Y4460 12035-50K00 12036-50K00 12036-R9000/23 12036-Y4460 12037-50K00 12038-R9000/23 12038-Y4460 12040-R9000	
NISSAN H20 Bore Dia. 87.2 mm 4 cyl. 1,982 cc FORKLIFT SOHC 8V	KBS94700	LB94700 length 150.0 outside diameter 91.2 flange diameter flange depth	KB94700 length 84.0 comp. height 41.0 +0 pin = 22.0 x 72.5 circlip required	KR94700 top 2.0 2nd 2.5 oil 4.0 N-SWN30-023/069 R-23141 T-34017	
			12010-74501 12010-74504 12010-74506 12010-74508 12010-79500	12033-14601 12033-50K00 12033-R9000/23 12033-Y4460 12035-50K00 12036-50K00 12036-R9000/23 12036-Y4460 12037-50K00 12038-R9000/23 12038-Y4460 12040-R9000	

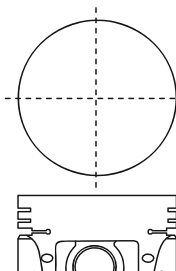
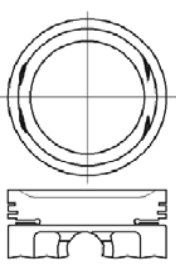
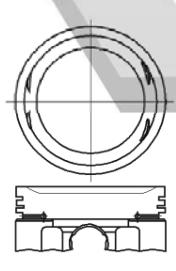

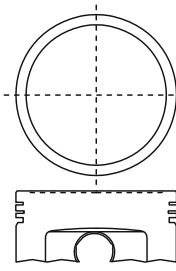
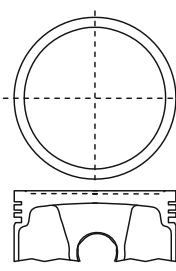
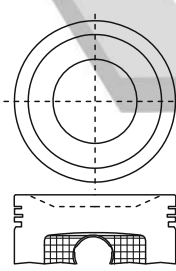
ENGINE MODEL	PISTON+RINGS	LAUFBUCHSE CYL. SLEEVE CAMISAS	KOLBENSATZ PISTON SET PISTONES KIT	RINGSATZ RING SET ANILLOS	KOLBEN PISTON PISTONES
NISSAN U20 Bore Dia. 87.2 mm 4 cyl. 1,982 cc SOHC 8V	KBS94710	LB94710 length 150.0 outside diameter 91.2 flange diameter flange depth	KB94710 length 84.2 comp. height 41.2 +0 pin = 22.0 x 72.5 circlip required	KR94710 top 2.0 2nd 2.0 oil 4.0 N- R- T-	
			12010-25511		
NISSAN Z24 Bore Dia. 89.0 mm 4 cyl. 2,389 cc 720 TRUCK DATSUN TRUCK SOHC 8V	KBS94720	LB94720 length 150.0 170.0 outside diameter 93.0 flange diameter flange depth 11012-10W01 11012-30W01	KB94720 length 70.5 comp. height 34.0 -4.0 pin = 21.0 x 66.5 circlip not required	KR94720 top 1.5 2nd 1.5 oil 4.0 N-SWN30-059 R-23270 T-34070 12010-30W01 12010-30W11 12033-10W00 12033-30W10	
NISSAN Z24 Z24I Bore Dia. 89.0 mm 4 cyl. 2,389 cc FORKLIFT URVAN VANETTE TERRANO D21 E24 GC22 H02 V02 WD21 (85-96) SOHC 8V	KBS94730	LB94730 length 150.0 170.0 outside diameter 93.0 flange diameter flange depth 11012-10W01 11012-30W01	KB94730 length 70.5 comp. height 34.0 -4.0 pin = 21.0 x 66.5 circlip not required	KR94730 top 2.0 2nd 1.5 oil 4.0 N-SWN30-085 R-23422/ 23423 23442 T-34077 12010-83W01 12010-83W02 12010-83W03 12010-83W11 12010-83W12 12010-83W13 12033-13A00 12033-13G00/10 12033-21G00/10 12033-83W00 12036-13G00/10 12036-21G00/10 12036-83W00 12038-13G00/10 12038-21G00/10 12038-83W00	

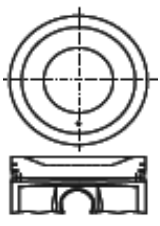
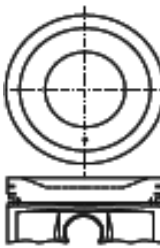
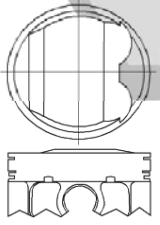
MOTOR - TYP	KOLBEN + RINGE PISTON + RINGS PISTONES + ANILLOS	LAUFBUCHSE CYL. SLEEVE CAMISAS	KOLBENSATZ PISTON SET PISTONES KIT	RINGSATZ RING SET ANILLOS	KOLBEN PISTON PISTONES
NISSAN KA24E Bore Dia. 89.0 mm 4 cyl. 2,389 cc	KBS20500 head, top and 2nd ring lands anodized	LB20500 length 150.0 170.0 outside diameter 93.0 flange diameter flange depth 11012-10W01 11012-30W01	KB20500 length 68.3 comp. height 34.0 -0.6	KR20500 top 1.5 2nd 1.5 oil 2.8	
			pin = 21.0 x 66.65 circlip not required 12010-86G20 12010-86G21 12010-86G22 12010-86G60 12010-86G61 12010-86G62 12010-86G72/73 A2010-86G20 A2010-86G21/22 A2010-86G72/73	N-SWN30-096/118 R-23125 / 23153 23935 T-34114 12033-1E400 12033-30R00 12033-4E100/10 12033-53F00/01 12033-70F00 12033-86G00/01 12036-30R02 12036-4E110 12036-53F02/03 12036-86G02/06 12036-G300A 12038-30R04 12038-4E110 12038-53F04/05 12038-86G04/08	
NISSAN KA24E Bore Dia. 89.0 mm 4 cyl. 2,389 cc	KBS20501 head, top and 2nd ring lands anodized	LB20501 length 150.0 170.0 outside diameter 93.0 flange diameter flange depth 11012-10W01 11012-30W01	KB20501 length 68.3 comp. height 34.0 -0.6	KR20501 top 1.5 2nd 1.5 oil 2.8	
TERRANO II KING CAB D21 D22 R20 (92-04) SOHC 12V			pin = 21.0 x 59.0 circlip required 12010-40F10 12010-40F11 12010-40F12 12010-40F72 12010-40F73 A2010-30R10 A2010-30R11 A2010-30R12 A2010-30R72 A2010-30R73	N-SWN30-096/118 R-23125 / 23153 23935 T-34114 12033-1E400 12033-30R00 12033-4E100/10 12033-53F00/01 12033-70F00 12033-86G00/01 12036-30R02 12036-4E110 12036-53F02/03 12036-86G02/06 12036-G300A 12038-30R04 12038-4E110 12038-53F04/05 12038-86G04/08	
NISSAN KA24DE Bore Dia. 89.0 mm 4 cyl. 2,389 cc	KBS20502 head, top and 2nd ring lands anodized	LB20502 length 150.0 170.0 outside diameter 93.0 flange diameter flange depth 11012-10W01 11012-30W01	KB20502 length 68.2 comp. height 34.0 -6.6	KR20502 top 1.5 2nd 1.5 oil 2.8	
240SX ALTIMA S13 U13U DOHC 16V			pin = 21.0 x 61.0 circlip required 12010-53F00 12010-53F01 12010-53F02 12010-53F72 12010-53F73 A2010-1E400 A2010-1E401 A2010-1E402 A2010-1E472 A2010-1E473	N-SWN30-096/118 R-23125 / 23153 23935 T-34114 12033-1E400 12033-30R00 12033-4E100/10 12033-53F00/01 12033-70F00 12033-86G00/01 12036-30R02 12036-4E110 12036-53F02/03 12036-86G02/06 12036-G300A 12038-30R04 12038-4E110 12038-53F04/05 12038-86G04/08	

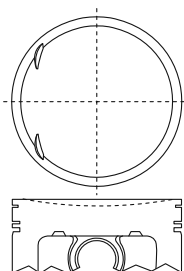
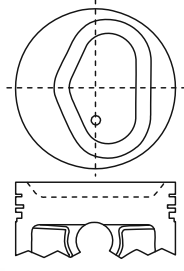
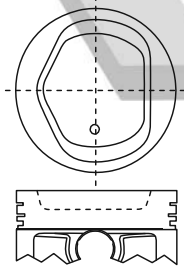
MOTOR - TYP	KOLBEN + RINGE PISTON + RINGS PISTONES + ANILLOS	LAUFBUCHSE CYL. SLEEVE CAMISAS	KOLBENSATZ PISTON SET PISTONES KIT	RINGSATZ RING SET ANILLOS	KOLBEN PISTON PISTONES
NISSAN KA24DE Bore Dia. 89.0 mm 4 cyl. 2,389 cc	KBS20503 head, top and 2nd ring lands anodized	LB20503 length 150.0 170.0 outside diameter 93.0 flange diameter flange depth 11012-10W01 11012-30W01	KB20503 length 60.8 comp. height 34.0 -6.4 pin = 21.0 x 56.9 circlip required A2010-9E000	KR20503 top 1.2 2nd 1.2 oil 2.5 N-SWN30-140 SWN30-143 R-23160/23165 T- 12033-5V110 12033-8H300 12033-8H301 12033-9E000 12033-9H500 12033-AE003 12035-8H300 12035-8H301 12035-AE003 A2033-AE003 A2035-AE003	
NISSAN KA24DE Bore Dia. 89.0 mm 4 cyl. 2,389 cc	KBS20504 head, top and 2nd ring lands anodized skirt MOS2 treated	LB20504 length 150.0 170.0 outside diameter 93.0 flange diameter flange depth 11012-10W01 11012-30W01	KB20504 length 60.8 comp. height 34.0 -6.5 pin = 21.0 x 56.9 circlip required A2010-5V110	KR20504 top 1.2 2nd 1.2 oil 2.5 N-SWN30-140 SWN30-143 R-23160/23165 T- 12033-5V110 12033-8H300 12033-8H301 12033-9E000 12033-9H500 12033-AE003 12035-8H300 12035-8H301 12035-AE003 A2033-AE003 A2035-AE003	
NISSAN QR20DE Bore Dia. 89.0 mm 4 cyl. 1,998 cc	KBS28000 head, top and 2nd ring lands anodized skirt MOS2 treated	LB28000 length outside diameter flange diameter flange depth	KB28000 length 56.9 comp. height 32.0 +1.9 pin = 20.0 x 59.0 circlip required A2010-8H311 A2010-8H312 A2010-8H376 A2010-8H501 A2010-8H502 A2010-8H571	KR28000 top 1.2 2nd 1.2 oil 2.5 N-SWN30-140 SWN30-143 R-23160/23165 T- 12033-5V110 12033-8H300 12033-8H301 12033-9E000 12033-9H500 12033-AE003 12035-8H300 12035-8H301 12035-AE003 A2033-AE003 A2035-AE003	

MOTOR - TYP	KOLBEN + RINGE PISTON + RINGS PISTONES + ANILLOS	LAUFBUCHSE CYL. SLEEVE CAMISAS	KOLBENSATZ PISTON SET PISTONES KIT	RINGSATZ RING SET ANILLOS	KOLBEN PISTON PISTONES
NISSAN QR25DE Bore Dia. 89.0 mm 4 cyl. 2,488 cc	KBS81000 head, top and 2nd ring lands anodized skirt MOS2 treated	LB81000 length outside diameter flange diameter flange depth	KB81000 length 54.9 comp. 32.0 height -4.1	KR81000 top 1.2 2nd 1.2 oil 2.5	
			pin = 20.0 x 57.0 circlip required A2010-9H511 A2010-9H512 A2010-9H576	N-SWN30-140 SWN30-143 R-23160/23165 T-	
X-TRAIL T30 (02-05) DOHC 16V				12033-5V110 12033-8H300 12033-8H301 12033-9E000 12033-9H500 12033-AE003 12035-8H300 12035-8H301 12035-AE003 A2033-AE003 A2035-AE003	
NISSAN K21 Bore Dia. 89.0 mm 4 cyl. 2,065 cc	KBS94750	LB94750 length 175.0 outside 93.0 diameter flange diameter flange depth	KB94750 length 58.0 comp. 32.5 height -7.7	KR94750 top 1.5 2nd 1.5 oil 2.8	
			pin = 20.0 x 57.0 circlip not required 12010-FU420 12010-FU421/22 12010-FU423/24 12016-FU470/71 12010-GS00A/B 12010-GS00C/D/E 12010-GS07A/B	N-SWN30-096/118 R-23125/ 23153 23935 T-34114 12033-1E400 12033-30R00 12033-4E100/10 12033-53F00/01 12033-70F00 12033-86G00/01 12036-30R02 12036-4E110 12036-53F02/03 12036-86G02/06 12036-G300A 12038-30R04 12038-4E110 12038-53F04/05 12038-86G04/08	
NISSAN K25 Bore Dia. 89.0 mm 4 cyl. 2,488 cc	KBS94760	LB94760 length 210.0 outside 93.0 diameter flange diameter flange depth	KB94760 length 58.0 comp. 32.5 height -9.9	KR94760 top 1.5 2nd 1.5 oil 2.8	
			pin = 20.0 x 57.0 circlip not required 12010-FU520 12010-FU521/22 12010-FU523/24 12010-FU570/71 12010-GS10A/B 12010-GS10C/D 12010-GS10E 12010-GS17A/B	N-SWN30-096/118 R-23125/ 23153 23935 T-34114 12033-1E400 12033-30R00 12033-4E100/10 12033-53F00/01 12033-70F00 12033-86G00/01 12036-30R02 12036-4E110 12036-53F02/03 12036-86G02/06 12036-G300A 12038-30R04 12038-4E110 12038-53F04/05 12038-86G04/08	

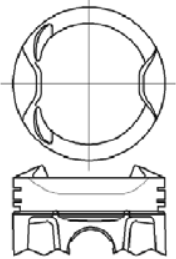
NISSAN

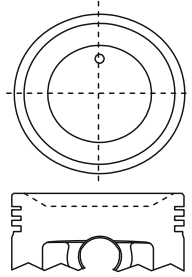
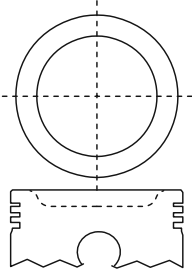
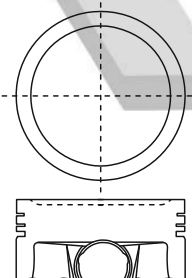

MOTOR - TYP	KOLBEN + RINGE PISTON + RINGS PISTONES + ANILLOS	LAUFBUCHSE CYL. SLEEVE CAMISAS	KOLBENSATZ PISTON SET PISTONES KIT	RINGSATZ RING SET ANILLOS	KOLBEN PISTON PISTONES
NISSAN QR25DE Bore Dia. 89.0 mm 4 cyl. 2,488 cc X-TRAIL T31 (07-) DOHC 16V	KBS81001 head, top and 2nd ring lands anodized skirt MOS2 treated	LB81001 length outside diameter flange diameter flange depth	KB81001 length comp. height pin = x	KR81001 top 2nd oil N- R- T-	
			A2010-JG31A A2010-JG32A A2010-JG39A	12033-JG30A 12035-JG30A	
NISSAN QR25DE Bore Dia. 89.0 mm 4 cyl. 2,488 cc ALTIMA ALTIMA HYBRID L32 L32HV (05-08) DOHC 16V	KBS81002 head, top and 2nd ring lands anodized skirt MOS2 treated	LB81002 length outside diameter flange diameter flange depth	KB81002 length 53.5 comp. height 32.4 -1.6 -6.6 pin = 20.0 x 57.0 circlip required	KR81002 top 1.2 2nd 1.2 oil 2.0 N- R- T-	
			12010-JA01A 12010-JA02A A2010-JA01A A2010-JA02A	12033-JA00B	
NISSAN KA24DE Bore Dia. 89.0 mm 4 cyl. 2,389 cc LARGO W30 (96-) DOHC 16V	KBS20505 head, top and 2nd ring lands anodized	LB20505 length 150.0 170.0 outside diameter 93.0 flange diameter flange depth 11012-10W01 11012-30W01	KB20505 length 68.2 comp. height 34.0 -6.6 pin = 21.0 x 61.0 circlip required A2010-53F00	KR20505 top 1.5 2nd 1.5 oil 2.8 N-SWN30-096/118 R-23125 / 23153 23935 T-34114 12033-1E400 12033-30R00 12033-4E100/10 12033-53F00/01 12033-70F00 12033-86G00/01 12036-30R02 12036-4E110 12036-53F02/03 12036-86G02/06 12036-G300A 12038-30R04 12038-4E110 12038-53F04/05 12038-86G04/08	

2012 NEW

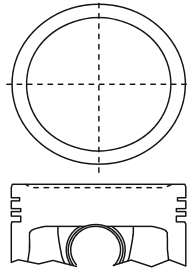
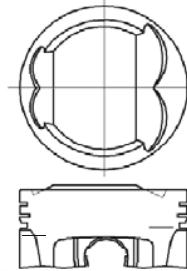
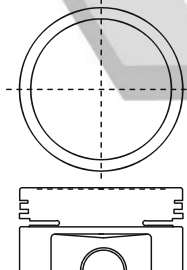
MOTOR - TYP	KOLBEN + RINGE PISTON + RINGS PISTONES + ANILLOS	LAUFBUCHSE CYL. SLEEVE CAMISAS	KOLBENSATZ PISTON SET PISTONES KIT	RINGSATZ RING SET ANILLOS	KOLBEN PISTON PISTONES
NISSAN H25 Bore Dia. 92.0 mm 4 cyl. 2,472 cc FORKLIFT D02S J02 J02S (93-00) SOHC 8V	KBS94780	LB94780 length 172.0 outside diameter 96.0 flange diameter flange depth	KB94780 length 71.0 comp. height 36.0 -7.3 pin = 21.0 x 72.0 circlip not required	KR94780 top 2.0 2nd 2.5 oil 4.0 N- R- T- 12010-60K00 12010-60K70 12010-60K71 12010-60K72	
			12033-60K00 12035-60K00 12036-60K00 12037-60K00		
NISSAN VQ20DE Bore Dia. 76.0 mm 6 cyl. 1,995 cc MAXIMA Ca33 (00) DOHC 24V	KBS94790	LB94790 length outside diameter flange diameter flange depth	KB94790 length 58.2 comp. height 30.4 -0.95 pin = 22.0 x 48.0 circlip required	KR94790 top 1.2 2nd 1.2 oil 2.5 N-SWN30-130 R-23002/ 23128 T-34112 12011-3Y500 A2011-3Y500 A2011-3Y501 A2011-3Y502 A2011-3Y571	
			12033-31U00 12033-31U01 12033-31U10 12033-3Y501 12033-3Y511 12035-31U00 12035-31U01 12035-31U10 12035-3Y501 12035-3Y511		
NISSAN VQ20DE Bore Dia. 76.0 mm 6 cyl. 1,995 cc MAXIMA CEFIRO A32 (94-96) DOHC 24V	KBS94800	LB94800 length outside diameter flange diameter flange depth	KB94800 length 58.2 comp. height 30.4 -0.95 pin = 22.0 x 48.0 circlip required	KR94800 top 1.2 2nd 1.2 oil 2.5 N-SWN30-130 R-23002/ 23128 T-34112 12010-31U60 A2010-31U60 A2010-31U61 A2010-31U62 A2010-31U71	
			12033-31U00 12033-31U01 12033-31U10 12033-3Y501 12033-3Y511 12035-31U00 12035-31U01 12035-31U10 12035-3Y501 12035-3Y511		

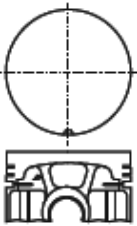
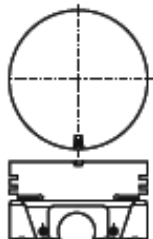
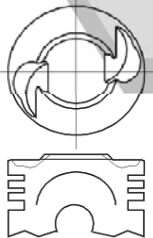
MOTOR - TYP	KOLBEN + RINGE PISTON + RINGS PISTONES + ANILLOS	LAUFBUCHSE CYL. SLEEVE CAMISAS	KOLBENSATZ PISTON SET PISTONES KIT	RINGSATZ RING SET ANILLOS	KOLBEN PISTON PISTONES
NISSAN VQ20DE Bore Dia. 76.0 mm 6 cyl. 1,995 cc	KBS94810	LB94810 length outside diameter flange diameter flange depth	length 58.1 comp. height 30.4 -1.0	top 1.2 2nd 1.2 oil 2.5	
			pin = 22.0 x 48.0 circlip required A2010-1L000 A2010-1L001 A2010-1L002 A2010-1L071	N-SWN30-130 R-23002/ 23128 T-34112 12033-31U00 12033-31U01 12033-31U10 12033-3Y501 12033-3Y511 12035-31U00 12035-31U01 12035-31U10 12035-3Y501 12035-3Y511	
NISSAN RB20 RB20E Bore Dia. 78.0 mm 6 cyl. 1,998 cc	KBS94820	LB94820 length outside diameter flange diameter flange depth	length 67.3 comp. height 32.4 +1.9	top 1.5 2nd 1.5 oil 2.8	
LAUREL SKYLINE SOHC 12V			pin = 19.0 x 62.4 circlip required 12010-55S01	N-SWN30-092 R-23230/ 23980 T- 12033-12P00 12033-65L00 12033-V5310	
NISSAN L20A II L20S Bore Dia. 78.0 mm 6 cyl. 1,998 cc	KBS94830	LB94830 length outside diameter flange diameter flange depth	length 75.2 comp. height 40.2 -0.5	top 1.5 2nd 2.0 oil 4.0	
			BLUEBIRD CEDRIC SKYLINE (75-77) SOHC 12V	pin = 20.0 x 61.0 circlip not required 12010-03L02 12010-14S01 12010-14S12	

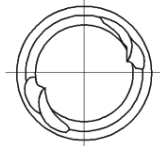
MOTOR - TYP	KOLBEN + RINGE PISTON + RINGS PISTONES + ANILLOS	LAUFBUCHSE CYL. SLEEVE CAMISAS	KOLBENSATZ PISTON SET PISTONES KIT	RINGSATZ RING SET ANILLOS	KOLBEN PISTON PISTONES
NISSAN L20A L20E Bore Dia. 78.0 mm 6 cyl. 1,998 cc CEDRIC LAUREL SKYLINE (75-85) SOHC 12V	KBS94840	LB94840	KB94840 length 79.3 comp. height 39.8 +0 pin = 21.0 x 66.5 circlip not required 12010-F5112 12010-Y7002 12010-Y7012	KR94840 top 1.2 2nd 2.0 oil 4.0 N- R-23841 T-34036 12033-Y7000 12033-Y7010 12033-Y7011	
NISSAN L20ET Bore Dia. 78.0 mm 6 cyl. 1,998 cc LEDRIC LAUREL SKYLINE (80-85) SOHC 12V	KBS94850	LB94850	KB94850 length 79.3 comp. height 39.8 +0 pin = 21.0 x 66.5 circlip not required 12010-E3001 12010-E3002	KR94850 top 2.0 2nd 2.0 oil 4.0 N-SWN30-037 R-23091 T-34025 12033-E3030 12033-V0300 12033-V0310 12033-V0400	
NISSAN VG20 Bore Dia. 78.0 mm 6 cyl. 1,998 cc CEDRIC FAIRLADY-Z (84-) SOHC 12V	KBS94860	LB94860	KB94860 length 67.2 comp. height 30.5 +1.7 pin = 20.0 x 61.0 circlip not required 12010-V5101 12010-V5111 12010-V6163	KR94860 top 1.5 2nd 1.5 oil 2.8 N-SWN30-092 R-23230/ 23980 T- 12033-12P00 12033-65L00 12033-V5310	

MOTOR - TYP	KOLBEN + RINGE PISTON + RINGS PISTONES + ANILLOS	LAUFBUCHSE CYL. SLEEVE CAMISAS	KOLBENSATZ PISTON SET PISTONES KIT	RINGSATZ RING SET ANILLOS	KOLBEN PISTON PISTONES
NISSAN VG20ET Bore Dia. 78.0 mm 6 cyl. 1,998 cc 200Z 200ZG LAUREL (84-) SOHC 12V	KBS94870	LB94870	length 65.5	top 1.5	 
			outside diameter 30.5	2nd 1.5	
			height -2.5	oil 2.8	
			flange diameter	pin = 20.0 x 61.0 circlip not required	
flange depth	12010-11P01 12010-V5311	12033-12P00 12033-65L00 12033-V5310			
NISSAN L26 Bore Dia. 83.0 mm 6 cyl. 2,565 cc BLUEBIRD CEDRIC LAUREL SKYLINE (68-73) SOHC 12V	KBS94880	LB94880	length 140.0	length 78.0	top 2.0
			outside diameter 87.0	comp. height 38.0	2nd 2.0
			flange diameter	height -1.9	oil 4.0
			flange depth	pin = 21.0 x 72.0 circlip required	N-SWN30-034 R-23890 T-34035
11012-21000	12010-23002 12010-23003 12010-23004 12010-23005 12010-23006 12010-23008 12010-E3101	12033-A8620 12033-E3100 12033-E3110 12033-W0810			
NISSAN L24 L26 Bore Dia. 83.0 mm 6 cyl. 2,393 2,565 cc BLUEBIRD CEDRIC LAUREL SKYLINE SOHC 12V	KBS94890	LB94890	length 140.0	length 78.2	top 2.0
			outside diameter 87.0	comp. height 38.7	2nd 2.0
			flange diameter	height -3.7	oil 4.0
			flange depth	pin = 21.0 x 72.0 circlip not required	N-SWN30-034 R-23890 T-34035
11012-21000	12010-H2711	12033-A8620 12033-E3100 12033-E3110 12033-W0810			

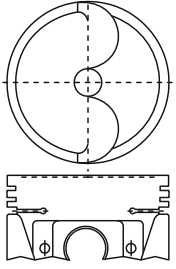
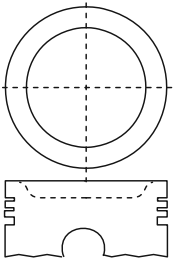
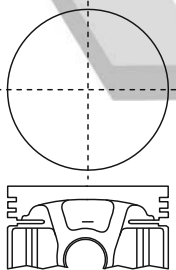
MOTOR - TYP	KOLBEN + RINGE PISTON + RINGS PISTONES + ANILLOS	LAUFBUCHSE CYL. SLEEVE CAMISAS	KOLBENSATZ PISTON SET PISTONES KIT	RINGSATZ RING SET ANILLOS	KOLBEN PISTON PISTONES
NISSAN L24 Bore Dia. 83.0 mm 6 cyl. 2,393 cc BLUEBIRD CEDRIC LAUREL SKYLINE SOHC 12V	KBS94900	LB94900 length 140.0 outside diameter 87.0 flange diameter flange depth 11012-21000	KB94900 length 78.0 comp. height 38.0 -0.8 pin = 21.0 x 72.0 circlip not required	KR94900 top 2.0 2nd 2.0 oil 4.0 N-SWN30-034 R-23890 T-34035 12033-A8620 12033-E3100 12033-E3110 12033-W0810	
			12010-H2501 12010-H2511 12010-H2512	12033-A8620 12033-E3100 12033-E3110 12033-W0810	
NISSAN L24 Bore Dia. 83.0 mm 6 cyl. 2,393 cc BLUEBIRD CEDRIC LAUREL SKYLINE SOHC 12V	KBS94901	LB94901 length 140.0 outside diameter 87.0 flange diameter flange depth 11012-21000	KB94901 length 78.2 comp. height 38.1 -3.0 pin = 21.0 x 73.0 circlip not required	KR94901 top 2.0 2nd 2.0 oil 4.0 N-SWN30-034 R-23890 T-34035 12033-A8620 12033-E3100 12033-E3110 12033-W0810	
			12010-A3500	12033-A8620 12033-E3100 12033-E3110 12033-W0810	
NISSAN L24 Bore Dia. 83.0 mm 6 cyl. 2,393 cc BLUEBIRD CEDRIC DATSUN 240Z DATSUN 260Z LAUREL SKYLINE SOHC 12V	KBS94902	LB94902 length 140.0 outside diameter 87.0 flange diameter flange depth 11012-21000	KB94902 length 78.0 comp. height 38.0 +0 pin = 21.0 x 72.0 circlip not required	KR94902 top 2.0 2nd 2.0 oil 4.0 N-SWN30-034 R-23890 T-34035 12033-A8620 12033-E3100 12033-E3110 12033-W0810	
			12010-E3111	12033-A8620 12033-E3100 12033-E3110 12033-W0810	

NISSAN

MOTOR - TYP	KOLBEN + RINGE PISTON + RINGS PISTONES + ANILLOS	LAUFBUCHSE CYL. SLEEVE CAMISAS	KOLBENSATZ PISTON SET PISTONES KIT	RINGSATZ RING SET ANILLOS	KOLBEN PISTON PISTONES
NISSAN L24E Bore Dia. 83.0 mm 6 cyl. 2,393 cc BLUEBIRD CEDRIC LAUREL SKYLINE SOHC 12V	KBS94910	LB94910 length 140.0 outside diameter 87.0 flange diameter flange depth 11012-21000	KB94910 length 78.2 comp. height 38.0 -2.9 pin = 21.0 x 72.0 circlip not required	KR94910 top 2.0 2nd 2.0 oil 4.0 N-SWN30-034 R-23890 T-34035	
			12010-A8601 12010-A8602 12010-A8612	12033-A8620 12033-E3100 12033-E3110 12033-W0810	
NISSAN L24 L24E Bore Dia. 83.0 mm 6 cyl. 2,393 cc BLUEBIRD MAXIMA SOHC 12V	KBS94920	LB94920 length 140.0 outside diameter 87.0 flange diameter flange depth 11012-21000	KB94920 length 78.1 comp. height 38.1 -1.2 pin = 21.0 x 72.0 circlip not required	KR94920 top 1.5 2nd 2.0 oil 4.0 N-SWN30-064 R-23350 T-34051	
			12010-27L02 12010-27L11	12033-W2400 12033-W2410 12033-W2420	
NISSAN L24E Bore Dia. 83.0 mm 6 cyl. 2,393 cc LAUREL C32 (85) SOHC 12V	KBS94911	LB94911 length 140.0 outside diameter 87.0 flange diameter flange depth 11012-21000	KB94911 length 65.0 comp. height 38.0 -0.9 pin = 20.0 x 61.0 circlip not required	KR94911 top 1.5 2nd 1.5 oil 4.0 N- R-23240/23260 T-34052	
			12010-51L01 12010-51L02 12010-51L03 12010-W3102 12010-W3104 12010-W3106	12033-51L00 12033-W3100 12036-W3100 12038-W3100	

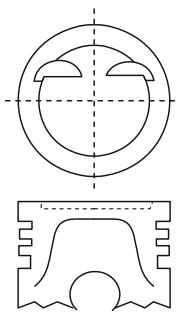
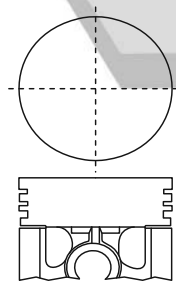
MOTOR - TYP	KOLBEN + RINGE PISTON + RINGS PISTONES + ANILLOS	LAUFBUCHSE CYL. SLEEVE CAMISAS	KOLBENSATZ PISTON SET PISTONES KIT	RINGSATZ RING SET ANILLOS	KOLBEN PISTON PISTONES
NISSAN L24E Bore Dia. 83.0 mm 6 cyl. 2,393 cc BLUEBIRD MAXIMA SOHC 12V	KBS94912	LB94912 length 140.0 outside diameter 87.0 flange diameter flange depth 11012-21000	KB94912 length 78.1 comp. height 38.1 -0.7 pin = 21.0 x 72.0 circlip not required	KR94912 top 1.5 2nd 2.0 oil 4.0 N-SWN30-064 R-23350 T-34051 12010-W2402 12033-W2400 12033-W2410 12033-W2420	
			length 58.75 comp. height 30.4 +0.55 pin = 22.0 x 54.0 circlip required	top 1.2 2nd 1.2 oil 2.0 N- R- T- 12011-2YA00 12011-9Y400 A2010-9Y400 A2010-9Y401 A2010-9Y402 A2010-9Y471 12033-AL501 12035-AL501	
			length 94.5 comp. height 53.2 +0 pin = 20.64 x 74.4 circlip not required	top 2.5 2nd 2.5 oil 4.73 N-SWN30-022 R-23460/ 23621 T-34007 12010-58000 12010-58002 12010-58003 12010-58100 12010-80005 12010-C8000 12010-C8003 12010-C8005 12010-C8010 12010-C8013/15 12033-58003 12033-58004 12033-58005 12033-58008 12033-C6000 12033-C6011 12036-58003 12038-58003	
NISSAN VQ23DE Bore Dia. 85.0 mm 6 cyl. 2,349 cc TEANA J31 (06-07) DOHC 24V	KBS94930	LB94930 length outside diameter flange diameter flange depth	KB94930 length 58.75 comp. height 30.4 +0.55 pin = 22.0 x 54.0 circlip required	KR94930 top 1.2 2nd 1.2 oil 2.0 N- R- T- 12011-2YA00 12011-9Y400 A2010-9Y400 A2010-9Y401 A2010-9Y402 A2010-9Y471 12033-AL501 12035-AL501	
NISSAN P40 Bore Dia. 85.7 mm 6 cyl. 3,956 cc CABSTAR FORKLIFT PATROL F05 (68-88) SOHC 12V	KBS94940	LB94940 length outside diameter flange diameter flange depth	KB94940 length 94.5 comp. height 53.2 +0 pin = 20.64 x 74.4 circlip not required	KR94940 top 2.5 2nd 2.5 oil 4.73 N-SWN30-022 R-23460/ 23621 T-34007 12010-58000 12010-58002 12010-58003 12010-58100 12010-80005 12010-C8000 12010-C8003 12010-C8005 12010-C8010 12010-C8013/15 12033-58003 12033-58004 12033-58005 12033-58008 12033-C6000 12033-C6011 12036-58003 12038-58003	

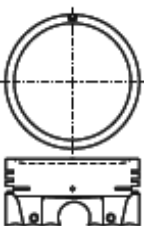
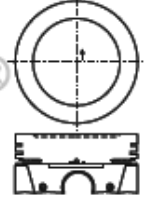
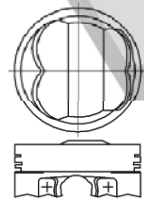
MOTOR - TYP	KOLBEN + RINGE PISTON + RINGS PISTONES + ANILLOS	LAUFBUCHSE CYL. SLEEVE CAMISAS	KOLBENSATZ PISTON SET PISTONES KIT	RINGSATZ RING SET ANILLOS	KOLBEN PISTON PISTONES
NISSAN L28E Bore Dia. 86.0 mm 6 cyl. 2,753 cc 280ZX S130 (78-82) SOHC 12V	KBS94950	LB94950 length 150.0 outside diameter 90.0 flange diameter flange depth 11012-N4200	KB94950 length 78.3 comp. height 38.3 -3.0 pin = 21.0 x 72.0 circlip not required	KR94950 top 2.0 2nd 2.0 oil 4.0 N-SWN30-047 R-23281 / 23550 T-34608	
			12010-Y4111 12010-Y4121 12010-Y4122 12010-Y4123 12010-Y4131	12033-M4210 12033-N4200 12033-N4210 12033-N4220 12033-P8360 12033-P8370 12036-N4200/20 12036-P8360/70 12038-N4200/20 12038-P8360/70	
NISSAN L28E Bore Dia. 86.0 mm 6 cyl. 2,753 cc 280ZX S130 (81) SOHC 12V	KBS94951	LB94951 length 150.0 outside diameter 90.0 flange diameter flange depth 11012-N4200	KB94951 length 78.2 comp. height 38.1 -0.65 pin = 21.0 x 72.0 circlip not required	KR94951 top 1.5 2nd 2.0 oil 4.0 N-SWN30-066/072 R-23560 / 23580 T-34055	
			12010-P8612 12010-P8615 12010-P8617	12033-P7900/10 12033-P8360 12033-P8600/10 12033-T8400 12036-P7900/10 12036-P8600/10 12036-T8400 12038-P7900/10 12038-P8600/10 12038-T8400	
NISSAN RB30 RB30E Bore Dia. 86.0 mm 6 cyl. 2,982 cc SKYLINE SOHC 12V	KBS94960	LB94960 length outside diameter flange diameter flange depth	KB94960 length 66.5 comp. height 32.5 +2.5 pin = 21.0 x 64.0 circlip required	KR94960 top 1.5 2nd 1.5 oil 2.8 N-SWN30-091 R-23490 T-34076	
			12010-67S11 12010-67S21 A2010-67S21	12033-67S10 12033-B4910	

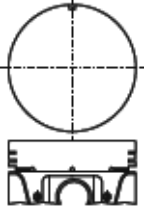
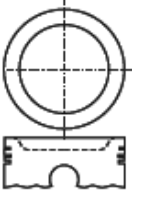
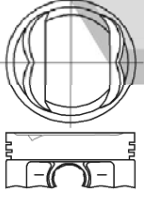
MOTOR - TYP	KOLBEN + RINGE PISTON + RINGS PISTONES + ANILLOS	LAUFBUCHSE CYL. SLEEVE CAMISAS	KOLBENSATZ PISTON SET PISTONES KIT	RINGSATZ RING SET ANILLOS	KOLBEN PISTON PISTONES
NISSAN L28 L28E Bore Dia. 86.0 mm 6 cyl. 2,753 cc 280ZX (83) SOHC 12V	KBS94970	LB94970 length 150.0 outside diameter 90.0 flange diameter flange depth 11012-N4200	KB94970 length 78.6 comp. height 38.6 +0	KR94970 top 1.5 2nd 2.0 oil 4.0	
			pin = 21.0 x 72.0 circlip not required 12010-P7902 12010-P7912	N-SWN30-066/072 R-23560 / 23580 T-34055 12033-P7900/10 12033-P8360 12033-P8600/10 12033-T8400 12036-P7900/10 12036-P8600/10 12036-T8400 12038-P7900/10 12038-P8600/10 12038-T8400	
NISSAN L28 Bore Dia. 86.0 mm 6 cyl. 2,753 cc PATROL 160 (81-86) SOHC 12V	KBS94980	LB94980 length 150.0 outside diameter 90.0 flange diameter flange depth 11012-N4200	KB94980 length 78.2 comp. height 38.1 -2.0	KR94980 top 1.5 2nd 2.0 oil 4.0	
			pin = 21.0 x 72.0 circlip not required 12010-C6412 12010-C6415 12010-C6417 12010-C6421 12010-C6422 12010-C6423	N-SWN30-066/072 R-23560 / 23580 T-34055 12033-P7900/10 12033-P8360 12033-P8600/10 12033-T8400 12036-P7900/10 12036-P8600/10 12036-T8400 12038-P7900/10 12038-P8600/10 12038-T8400	
NISSAN RB30 RB30E Bore Dia. 86.0 mm 6 cyl. 2,982 cc SKYLINE SOHC 12V	KBS94990	LB94990 length outside diameter flange diameter flange depth	KB94990 length 63.8 comp. height 32.5 -1.6	KR94990 top 1.5 2nd 1.5 oil 2.8	
			head anodized	pin = 21.0 x 64.0 circlip required	

NISSAN

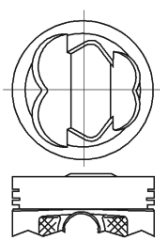
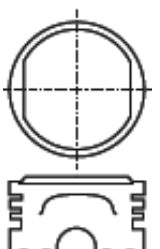
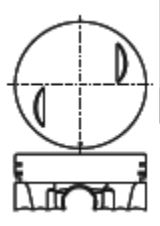
MOTOR - TYP	KOLBEN + RINGE PISTON + RINGS PISTONES + ANILLOS	LAUFBUCHSE CYL. SLEEVE CAMISAS	KOLBENSATZ PISTON SET PISTONES KIT	RINGSATZ RING SET ANILLOS	KOLBEN PISTON PISTONES
NISSAN RB24 RB24S Bore Dia. 86.0 mm 6 cyl. 2,428 cc CEFIROS SOHC 12V	KBS95000	LB95000 length outside diameter flange diameter flange depth	length 66.0 comp. height 32.5 +2.0	top 1.5 2nd 1.5 oil 2.8	
			pin = 21.0 x 64.0 circlip required	N-SWN30-091 R-23490 T-34076	
			12010-76L01	12033-67S10 12033-B4910	
NISSAN Bore Dia. 86.0 mm 6 cyl. cc	KBS95010	LB95010 length outside diameter flange diameter flange depth	length 63.0 comp. height 30.0 +3.5	top 1.5 2nd 1.5 oil 2.8	
			pin = 21.0 x 69.0 circlip required	N-SWN30-091 R-23490 T-34076	
			12010-05U11	12033-67S10 12033-B4910	
NISSAN VG30 VG30E Bore Dia. 87.0 mm 6 cyl. 2,960 cc 300ZX LAUREL C32 Z31 (84-87) DOHC 12V	KBS95020	LB95020 length outside diameter flange diameter flange depth	length 67.0 comp. height 32.0 +0	top 1.5 2nd 1.5 oil 2.8	
			pin = 21.0 x 64.0 circlip required	N-SWN30-058/094 SWN30-108 R-23590/ 23950 T-34065	
			12010-21P12/13 12010-21P61/62 12010-21P63/64/65 12010-V5901/02/03 12010-V5910/11/12 12010-V5913/61/62 12010-V5963/64/65 12010-V7101/02 12010-V7103/61/62 12010-V7163/64/65	12033-02/21P10 12033/35-03P00/10 12033/35/36-07P00 12033/35/36-17V00/01 12033-21V00 12033/35-21P00/10 12033/35/36-90E00/01 12033-96E01 12033-F6500 12033/35/36-F6510/11 12033/35/36-V8010	

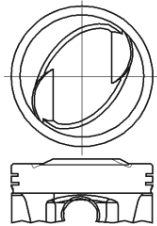
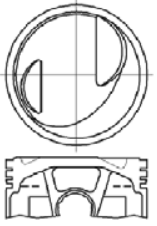
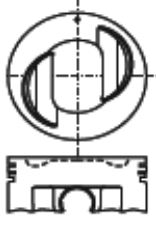
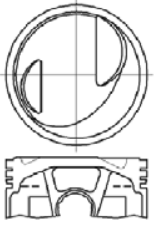
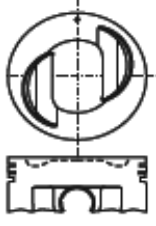
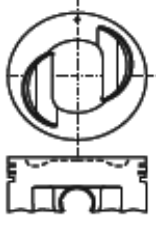
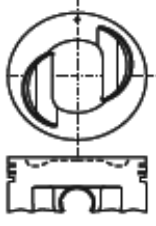
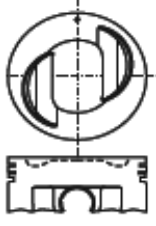
MOTOR - TYP	KOLBEN + RINGE PISTON + RINGS PISTONES + ANILLOS	LAUFBUCHSE CYL. SLEEVE CAMISAS	KOLBENSATZ PISTON SET PISTONES KIT	RINGSATZ RING SET ANILLOS	KOLBEN PISTON PISTONES
NISSAN VG30E Bore Dia. 87.0 mm 6 cyl. 2,960 cc	KBS95060	LB95060	KB95060	KR95060	
MAXIMA J30 (88-91) DOHC 12V	KBS95070	LB95070	KB95070	KR95070	
NISSAN VG30E (L/R) Bore Dia. 87.0 mm 6 cyl. 2,960 cc	KBS95080	LB95080	KB95080	KR95080	
CEDRIC MAXIMA (83-95) DOHC 12V	KBS95070	LB95070	KB95070	KR95070	
NISSAN VG33E (L/R) Bore Dia. 91.5 mm 6 cyl. 3,275 cc	KBS95080	LB95080	KB95080	KR95080	
TERRAND R50 (97-00) DOHC 12V	KBS95080	LB95080	KB95080	KR95080	
TERRAND R50 (97-00) DOHC 12V	KBS95080	LB95080	KB95080	KR95080	
TERRAND R50 (97-00) DOHC 12V	KBS95080	LB95080	KB95080	KR95080	

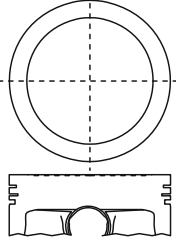
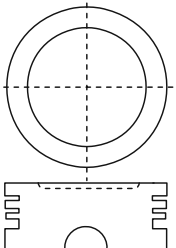
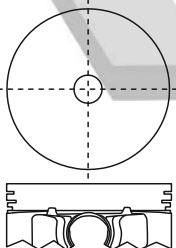
MOTOR - TYP	KOLBEN + RINGE PISTON + RINGS PISTONES + ANILLOS	LAUFBUCHSE CYL. SLEEVE CAMISAS	KOLBENSATZ PISTON SET PISTONES KIT	RINGSATZ RING SET ANILLOS	KOLBEN PISTON PISTONES	
NISSAN VQ30DE Bore Dia. 93.0 mm 6 cyl. 2,960 cc	KBS95090 head anodized skirt MOS2 treated	LB95090 length outside diameter flange diameter flange depth	KB95090 length 58.3 comp. 30.2 height -0.4	KR95090 top 1.2 2nd 1.2 oil 2.5		
			pin = 22.0 x 58.0 circlip required A2010-38U10 A2010-38U11 A2010-38U12 A2010-38U71 A2010-39U00 A2010-39U01 A2010-39U02 A2010-39U71	N-SWN30-115/119 R-23016 T-34091 12033-2Y900/01 12033-2Y902/03 12033-38U00/01/02 12033-47001 12033-47U01 12035-2Y900/01 12035-2Y902/03 12035-38U00/01/02 12035-47001 12035-47U03 12035-AG301		
MAXIMA A32 (94-98) DOHC 24V	NISSAN VQ30DE Bore Dia. 93.0 mm 6 cyl. 2,960 cc	KBS95091 head anodized skirt MOS2 treated	LB95091 length outside diameter flange diameter flange depth	KB95091 length 58.0 comp. 30.4 height -0.5	KR95091 top 1.2 2nd 1.2 oil 2.5	
				pin = 22.0 x 58.0 circlip required A2010-2Y900 A2010-2Y901 A2010-2Y902 A2010-2Y910 A2010-2Y911 A2010-2Y912 A2010-2Y971 A2010-2Y976	N-SWN30-115/119 R-23016 T-34091 12033-2Y900/01 12033-2Y902/03 12033-38U00/01/02 12033-47001 12033-47U01 12035-2Y900/01 12035-2Y902/03 12035-38U00/01/02 12035-47001 12035-47U03 12035-AG301	
MAXIMA CA33 (00) DOHC 24V	NISSAN VQ35DE Bore Dia. 95.5 mm 6 cyl. 3,498 cc	KBS64001 head, top and 2nd ring lands anodized skirt MOS2 treated	LB64001 length outside diameter flange diameter flange depth	KB64001 length 53.1 comp. 29.6 height +0	KR64000 top 1.2 2nd 1.2 oil 2.5	
				pin = 22.0 x 58.0 circlip not required A2010-4W100 A2010-4W101 A2010-4W102 A2010-4W110 A2010-4W111 A2010-4W112 A2010-4W170 A2010-4W171	N-SWN30-131/132 R-23830 T-34130 12033-4W003/4 12033-4W005/7 12033-8J100 12033-JP00A 12035-4W003 12035-4W004 12035-4W005 12035-4W007 12035-8J100	
TERRANO R50 (00-01) DOHC 24V						

NISSAN

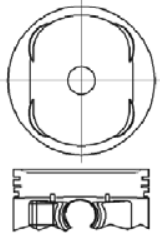
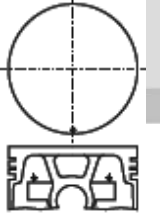
MOTOR - TYP	KOLBEN + RINGE PISTON + RINGS PISTONES + ANILLOS	LAUFBUCHSE CYL. SLEEVE CAMISAS	KOLBENSATZ PISTON SET PISTONES KIT	RINGSATZ RING SET ANILLOS	KOLBEN PISTON PISTONES
NISSAN VQ35DE Bore Dia. 95.5 mm 6 cyl. 3,498 cc 350Z MURAND TEANA INFINITI FX35/M35 Z33 Z50 J31 S50 Y50 (03-) DOHC 24V	KBS64000	LB64000 length outside diameter flange diameter flange depth	KB64000 length comp. height pin = x	KR64000 top 1.2 2nd 1.2 oil 2.5 N-SWN30-131/132 R-23830 T-34130	
			A2010-8J110 A2010-8J111 A2010-8J112 A2010-8J172	12033-4W003/4 12033-4W005/7 12033-8J100 12033-JP00A 12035-4W003 12035-4W004 12035-4W005 12035-4W007 12035-8J100	
NISSAN VQ40DE Bore Dia. 95.5 mm 6 cyl. 3,954 cc PATHFINDER R51 R51M (04-08) DOHC 24V	KBS46500 head, top and 2nd ring lands anodized skirt MOS2 treated	LB46500 length outside diameter flange diameter flange depth	KB46500 length 55.1 comp. 31.6 height -2.0 -2.7 pin = 22.0 x 58.0 circlip required	KR46500 top 1.2 2nd 1.2 oil 2.5 N-SWN30-131/132 R-23830 T-34130	
			12010-EA200 12010-EA201 12010-EA202	12033-4W003/4 12033-4W005/7 12033-8J100 12033-JP00A 12035-4W003 12035-4W004 12035-4W005 12035-4W007 12035-8J100	
NISSAN TB42 Bore Dia. 96.0 mm 6 cyl. 4,169 cc FORKLIFT PATROL F03 F05 Y60 (88-89) SOHC 12V	KBS95100	LB95100 length outside diameter flange diameter flange depth	KB95100 length 80.0 comp. 40.5 height +0 pin = 23.0 x 76.0 circlip required	KR95100 top 2.0 2nd 2.0 oil 4.0 N-SWN30-122 R-23121 T-34087	
			12010-03J10 12010-03J11 12010-03J61 12010-03J62 12010-03J63 12010-03J64 12010-03J65	12033-03J00 12033-03J10 12036-03J00 12038-03J00	

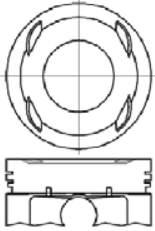
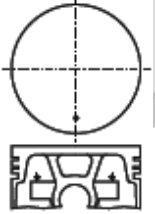
MOTOR - TYP	KOLBEN + RINGE PISTON + RINGS PISTONES + ANILLOS	LAUFBUCHSE CYL. SLEEVE CAMISAS	KOLBENSATZ PISTON SET PISTONES KIT	RINGSATZ RING SET ANILLOS	KOLBEN PISTON PISTONES
NISSAN VH45DE Bore Dia. 93.0 mm 8 cyl. 4,494 cc	KBS95110 skirt MOS2 treated	LB95110 length outside diameter flange diameter flange depth	KB95110 length 62.5 comp. 32.0 height -1.7 -1.9	KR95110 top 1.5 2nd 1.5 oil 2.8	
			pin = 22.0 x 61.0 circlip required A2010-60U00 A2010-60U01 A2010-60U02 A2010-60U71	N- R- T- 12033-60U00 12033-60U01 12033-60U02 12035-60U00 12035-60U01 12035-60U02	
INFINITI Q45 PRESIDENT G50 (89-02) DOHC 32V					
NISSAN VK56DE Bore Dia. 98.0 mm 8 cyl. 5,552 cc	KBS95120 head, top and 2nd ring lands anodized skirt MOS2 treated	LB95120 length outside diameter flange diameter flange depth	KB95120 length 52.0 comp. 31.6 height -2.2 -4.2	KR95120 top 1.5 2nd 1.5 oil 2.5	
			pin = 22.0 x 59.6 circlip required 12010-7S000 12010-7S001 12010-7S002 A2010-7S000 A2010-7S001 A2010-7S002	N-SWN30-149 R- T- 12033-7S000 12033-7S001 12033-7S002 12033-ZE00A	
ARMADA INFINITI QX56 J60A TA60 (03-08) DOHC 32V					
NISSAN TB45 Bore Dia. 99.5 mm 6 cyl. 4,169 cc	KBS95130 head, top and 2nd ring lands anodized	LB95130 length outside diameter flange diameter flange depth	KB95130 length 80.0 comp. 40.3 height +0	KR95130 top 2.0 2nd 1.5 oil 4.0	
			pin = 23.0 x 65.0 circlip required A2010-VB010 A2010-VB011 A2010-VB061 A2010-VB062 A2010-VB063 A2010-VB064	N-SWN30-181 R-23665 T-34104 12033-VB000 12033-VC200 12036-VB000 12038-VB000	
FORKLIFT PATROL SAFARI Y61 (97-02) SOHC 12V					

2012 NEW

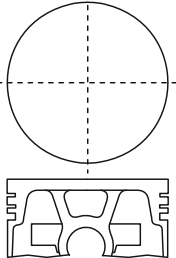
MOTOR - TYP	KOLBEN + RINGE PISTON + RINGS PISTONES + ANILLOS	LAUFBUCHSE CYL. SLEEVE CAMISAS	KOLBENSATZ PISTON SET PISTONES KIT	RINGSATZ RING SET ANILLOS	KOLBEN PISTON PISTONES
NISSAN TB48DE Bore Dia. 99.5 mm 6 cyl. 4,759 cc	KBS95140 top and 2nd ring lands anodized	LB95140 length outside diameter flange diameter flange depth	length 80.0 comp. height 40.3 +0	top 2.0 2nd 1.5 oil 4.0	
			pin = 23.0 x 61.0 circlip required A2010-VC200 A2010-VC201 A2010-VC202 A2010-VC203 A2010-VC204 A2010-VC210 A2010-VC211	N-SWN30-181 R-23665 T-34104 12033-VB000 12033-VC200 12036-VB000 12038-VB000	
FORKLIFT PATROL SAFARI Y61 (97-02) SOHC 12V					2012 NEW
		length outside diameter flange diameter flange depth	length comp. height pin = x	top 2nd oil N- R- T-	
		length outside diameter flange diameter flange depth	length comp. height pin = x	top 2nd oil N- R- T-	

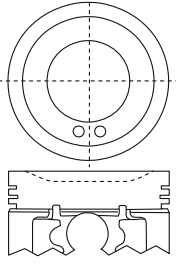
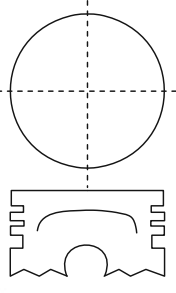
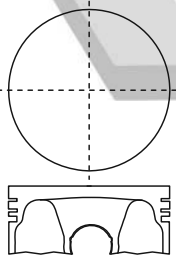
MOTOR - TYP	KOLBEN + RINGE PISTON + RINGS PISTONES + ANILLOS	LAUFBUCHSE CYL. SLEEVE CAMISAS	KOLBENSATZ PISTON SET PISTONES KIT	RINGSATZ RING SET ANILLOS	KOLBEN PISTON PISTONES
SAMSUNG SM3 Bore Dia. 73.6 mm 4 cyl. 1,497 cc DOHC	KBS95150	LB95150 length outside diameter flange diameter flange depth	length 51.6 comp. height 29.1 -4.8	top 1.5 2nd 1.5 oil 2.8	
			pin = 19.0 x 49.0 circlip required	N- R- T-	
SAMSUNG SM5 Bore Dia. 82.5 mm 4 cyl. 1,838 cc DOHC	KBS95160	LB95160 length outside diameter flange diameter flange depth	length 63.0 comp. height 32.0 +0	top 1.5 2nd 1.5 oil 3.0	
			pin = 22.0 x 56.0 circlip required	N- R- T-	
SAMSUNG SM5 Bore Dia. 86.0 mm 4 cyl. 1,998 cc DOHC	KBS95161	LB95161 length outside diameter flange diameter flange depth	length 63.0 comp. height 32.0 +0	top 1.5 2nd 1.5 oil 3.0	
			pin = 22.0 x 60.0 circlip required	N- R- T-	

SAMSUNG

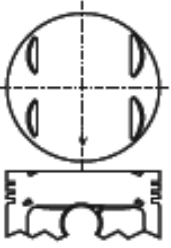
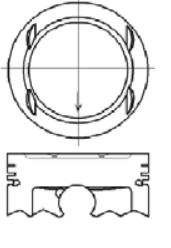
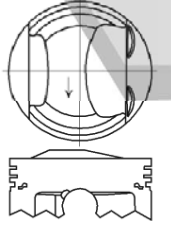
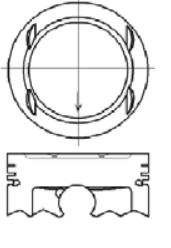
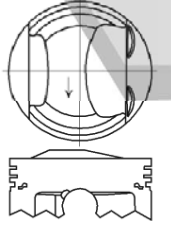
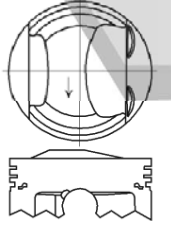
MOTOR - TYP	KOLBEN + RINGE PISTON + RINGS PISTONES + ANILLOS	LAUFBUCHSE CYL. SLEEVE CAMISAS	KOLBENSATZ PISTON SET PISTONES KIT	RINGSATZ RING SET ANILLOS	KOLBEN PISTON PISTONES																																																																		
SSANGYONG M111 Bore Dia. 89.9 mm 4 cyl. 1,998 cc KORANDO MUSSO 16V	KBS86000	LB86000	KB86000	KR86000		skirt MOS2 treated	length	length 55.65	top 1.5		outside diameter	comp. height 36.65 -1.55 -2.05	2nd 1.75 oil 3.0		flange diameter	pin = 22.0 x 56.0 circlip required	N- R- T-			flange depth				SSANGYONG M111 Bore Dia. 89.9 mm 4 cyl. 1,998 cc KORANDO MUSSO 16V	KBS86001	LB86001	KB86001	KR86001		skirt MOS2 treated	length	length 55.15	top 1.5		outside diameter	comp. height 31.65 -2.35	2nd 1.75 oil 3.0		flange diameter	pin = 22.0 x 56.0 circlip required	N- R- T-			flange depth				SSANGYONG M111 Bore Dia. 89.9 mm 4 cyl. 1,998 cc KORANDO MUSSO 16V	KBS86002	LB86002	KB86002	KR86002			length	length 59.5	top 1.5		outside diameter	comp. height 30.0 +6.0	2nd 1.75 oil 3.0		flange diameter	pin = 22.0 x 56.0 circlip required	N- R- T-			flange depth			
						skirt MOS2 treated	length	length 55.65	top 1.5																																																														
							outside diameter	comp. height 36.65 -1.55 -2.05	2nd 1.75 oil 3.0																																																														
							flange diameter	pin = 22.0 x 56.0 circlip required	N- R- T-																																																														
		flange depth																																																																					
SSANGYONG M111 Bore Dia. 89.9 mm 4 cyl. 1,998 cc KORANDO MUSSO 16V	KBS86001	LB86001	KB86001	KR86001		skirt MOS2 treated	length	length 55.15	top 1.5		outside diameter	comp. height 31.65 -2.35	2nd 1.75 oil 3.0		flange diameter	pin = 22.0 x 56.0 circlip required	N- R- T-			flange depth				SSANGYONG M111 Bore Dia. 89.9 mm 4 cyl. 1,998 cc KORANDO MUSSO 16V	KBS86002	LB86002	KB86002	KR86002			length	length 59.5	top 1.5		outside diameter	comp. height 30.0 +6.0	2nd 1.75 oil 3.0		flange diameter	pin = 22.0 x 56.0 circlip required	N- R- T-			flange depth																											
						skirt MOS2 treated	length	length 55.15	top 1.5																																																														
							outside diameter	comp. height 31.65 -2.35	2nd 1.75 oil 3.0																																																														
							flange diameter	pin = 22.0 x 56.0 circlip required	N- R- T-																																																														
		flange depth																																																																					
SSANGYONG M111 Bore Dia. 89.9 mm 4 cyl. 1,998 cc KORANDO MUSSO 16V	KBS86002	LB86002	KB86002	KR86002			length	length 59.5	top 1.5		outside diameter	comp. height 30.0 +6.0	2nd 1.75 oil 3.0		flange diameter	pin = 22.0 x 56.0 circlip required	N- R- T-			flange depth																																																			
							length	length 59.5	top 1.5																																																														
							outside diameter	comp. height 30.0 +6.0	2nd 1.75 oil 3.0																																																														
							flange diameter	pin = 22.0 x 56.0 circlip required	N- R- T-																																																														
		flange depth																																																																					

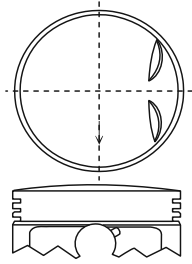
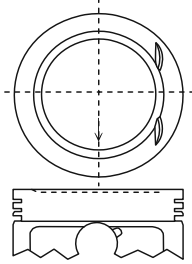
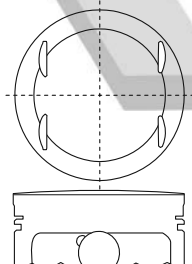
MOTOR - TYP	KOLBEN + RINGE PISTON + RINGS PISTONES + ANILLOS	LAUFBUCHSE CYL. SLEEVE CAMISAS	KOLBENSATZ PISTON SET PISTONES KIT	RINGSATZ RING SET ANILLOS	KOLBEN PISTON PISTONES
SSANGYONG M111 Bore Dia. 90.9 mm 4 cyl. 2,295 cc KORANDO MUSSO 16V	KBS86003 skirt MOS2 treated	LB86003 length outside diameter flange diameter flange depth	KB86003	KR86003	
			length 57.9	top 1.5	
			comp. height 30.0 +2.9	2nd 1.75 oil 3.0	
			pin = 22.0 x 56.0 circlip required	N- R- T-	
SSANGYONG M111 Bore Dia. 90.9 mm 4 cyl. 2,295 cc KORANDO MUSSO 16V	KBS86004 skirt MOS2 treated	LB86004 length outside diameter flange diameter flange depth	KB86004	KR86004	
			length 55.0	top 1.5	
			comp. height 30.0 -1.1	2nd 1.75 oil 3.0	
			pin = 22.0 x 56.0 circlip required	N- R- T-	
SSANGYONG M104 Bore Dia. 89.9 mm 6 cyl. 2,799 cc CHAIRMAN 24V	KBS95170	LB95170 length outside diameter flange diameter flange depth	KB95170	KR95170	
			length 57.1	top 1.5	
			comp. height 32.4 +1.2	2nd 1.75 oil 3.0	
			pin = 22.0 x 56.0 circlip required	N- R- T-	

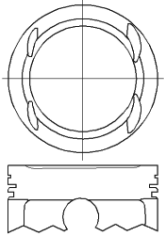
MOTOR - TYP	KOLBEN + RINGE PISTON + RINGS PISTONES + ANILLOS	LAUFBUCHSE CYL. SLEEVE CAMISAS	KOLBENSATZ PISTON SET PISTONES KIT	RINGSATZ RING SET ANILLOS	KOLBEN PISTON PISTONES																																																															
SSANGYONG M104 Bore Dia. 89.9 mm 6 cyl. 3,199 cc MUSSO REXTON RX 24V	KBS95171	LB95171	KB95171	KR95171		length	length 54.6	top 1.5	outside diameter	comp. height 31.1 -1.2	2nd 1.75 oil 3.0	flange diameter	pin = 22.0 x 56.0 circlip required	N- R- T-			flange depth						length	length	top				outside diameter	comp. height	2nd				flange diameter	pin = x	oil				flange depth		N- R- T-				length	length	top				outside diameter	comp. height	2nd				flange diameter	pin = x	oil				flange depth		N- R- T-	
						length	length 54.6	top 1.5																																																												
						outside diameter	comp. height 31.1 -1.2	2nd 1.75 oil 3.0																																																												
						flange diameter	pin = 22.0 x 56.0 circlip required	N- R- T-																																																												
		flange depth																																																																		
		length	length	top																																																																
		outside diameter	comp. height	2nd																																																																
		flange diameter	pin = x	oil																																																																
		flange depth		N- R- T-																																																																
		length	length	top																																																																
		outside diameter	comp. height	2nd																																																																
		flange diameter	pin = x	oil																																																																
		flange depth		N- R- T-																																																																

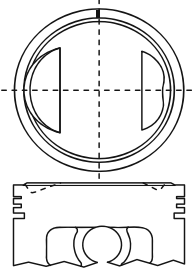
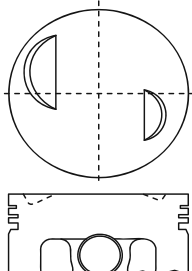
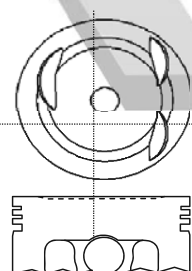
MOTOR - TYP	KOLBEN + RINGE PISTON + RINGS PISTONES + ANILLOS	LAUFBUCHSE CYL. SLEEVE CAMISAS	KOLBENSATZ PISTON SET PISTONES KIT	RINGSATZ RING SET ANILLOS	KOLBEN PISTON PISTONES		
SUBARU EK23 New Bore Dia. 76.0 mm 2 cyl. 544 cc REX 550 SANBA 550 TRUCK OHC 4V	KBS95180	LB95180	length	length 54.0	top 1.5		
			outside diameter	comp. height 27.8 +1.0	2nd 1.5		oil 2.8
			flange diameter	pin = 17.0 x 62.0 circlip required	N-SWF20-023 R-14020 T-35514		
			flange depth	41351-5401	48003-5400		
SUBARU EF10 Bore Dia. 78.0 mm 3 cyl. 997 cc DOMINGO JUSTY SOHC 6V	KBS95190	LB95190	length	length 55.35	top 1.2		
			outside diameter	comp. height 28.35 -2.87 -4.77	2nd 1.5		oil 2.8
			flange diameter	pin = 18.0 x 61.0 circlip required	N-SWF20-052/054 R-14270/ 14470 14480 T-35520/ 35521		
			flange depth	12009-KA121 12011-KA920	12033-KA181 48003-5600 48003-5610 48003-5700 48003-5800		
SUBARU EF12 Bore Dia. 78.0 mm 3 cyl. 1,189 cc JUSTY SOHC 9V	KBS95200	LB95200	length	length 55.0	top 1.2		
			outside diameter	comp. height 28.0 -1.1	2nd 1.5		oil 2.8
			flange diameter	pin = 18.0 x 61.0 circlip required	N-SWF20-052/054 R-14270/ 14470 14480 T-35520/ 35521		
			flange depth	12009-KB060	12033-KA181 48003-5600 48003-5610 48003-5700 48003-5800		

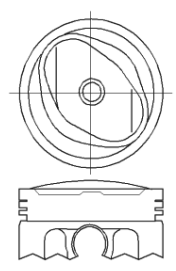
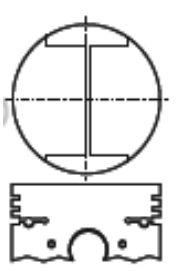
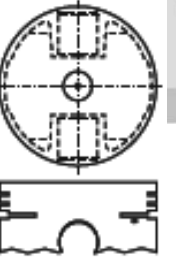
MOTOR - TYP	KOLBEN + RINGE PISTON + RINGS PISTONES + ANILLOS	LAUFBUCHSE CYL. SLEEVE CAMISAS	KOLBENSATZ PISTON SET PISTONES KIT	RINGSATZ RING SET ANILLOS	KOLBEN PISTON PISTONES
SUBARU EF10 Bore Dia. 78.0 mm 3 cyl. 997 cc CARBURETOR SOHC 6V	KBS95210	LB95210 length outside diameter flange diameter flange depth	length 55.4 comp. height 28.4 -3.3	top 1.2 2nd 1.5 oil 2.8	
			pin = 18.0 x 61.0 circlip required	N-SWF20-052/054 R-14270/ 14470 14480 T-35520/ 35521	
			12033-KA181 48003-5600 48003-5610 48003-5700 48003-5800		
SUBARU EA61 Bore Dia. 76.0 mm 4 cyl. 1,088 cc FF-1 STARG G (70-72) OHV	KBS95220	LB95220 length outside diameter flange diameter flange depth	length 65.7 comp. height 32.7 +0	top 2.0 2nd 2.0 oil 4.0	
			pin = 19.0 x 67.0 circlip required	N-SXF20-007 R- T-35508	
			88005-6100	88003-6100	
SUBARU EA65 New Bore Dia. 83.0 mm 4 cyl. 1,298 cc CABBURETOR OHV 8V	KBS95230	LB95230 length outside diameter flange diameter flange depth	length 67.0 comp. height 32.0 +0	top 1.2 2nd 1.5 oil 4.0	
			pin = 21.0 x 74.0 circlip required	N-SWF20-032 R-14640 T-35522	
			48005-7010	48003-7010	

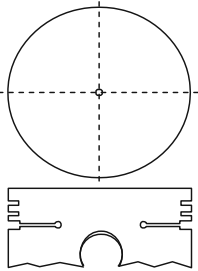
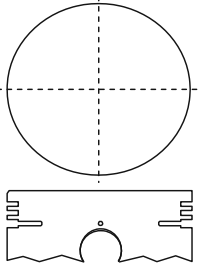
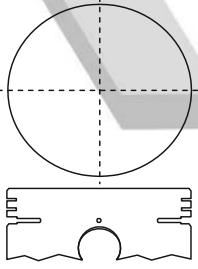
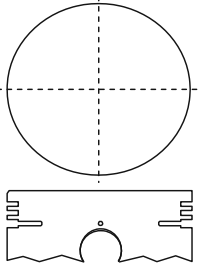
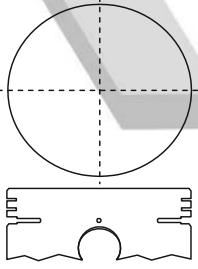
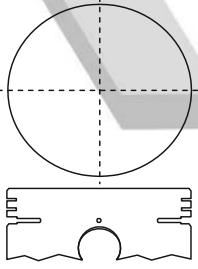
MOTOR - TYP	KOLBEN + RINGE PISTON + RINGS PISTONES + ANILLOS	LAUFBUCHSE CYL. SLEEVE CAMISAS	KOLBENSAT PISTON SET PISTONES KIT	RINGSATZ RING SET ANILLOS	KOLBEN PISTON PISTONES																																																									
SUBARU EA63 Bore Dia. 85.0 mm 4 cyl. 1,361 cc LEONE (73-76) OHV	KBS95240	LB95240	KB95240	KR95240		length	length 67.5	top 2.0	outside diameter	comp 32.5 height +0	2nd 2.0 oil 4.0	flange diameter	pin = 20.0 x 76.0	N-SWF20-014			flange depth	circlip required 38005-0100	R-14540 T-35509 38003-0110		SUBARU EA71 Bore Dia. 92.0 mm 4 cyl. 1,595 cc LEONE ` BRAT (76-87) OHV	KBS95250	LB95250	KB95250	KR95250		length	length 71.5	top 2.0	outside diameter	comp. 32.0 height +0	2nd 2.0 oil 4.0	flange diameter	pin = 21.0 x 82.0 circlip required	N-SWF20-017 R-14200 T-35510			flange depth	38005-4300 38005-4310 38005-4320	38003-4300 38003-4320		SUBARU EA71 New Bore Dia. 92.0 mm 4 cyl. 1,595 cc LEONE ` BRAT (76-87) OHV	KBS95260	LB95260	KB95260	KR95260		length	length 71.1	top 1.2	outside diameter	comp. 31.6 height +0	2nd 1.5 oil 4.0	flange diameter	pin = 21.0 x 82.0 circlip required	N-SWF20-039/057 R-14070 / 14510 T-35517			flange depth	48005-7100	12033-AA000 12033-AA330 48003-7100	
						length	length 67.5	top 2.0																																																						
						outside diameter	comp 32.5 height +0	2nd 2.0 oil 4.0																																																						
						flange diameter	pin = 20.0 x 76.0	N-SWF20-014																																																						
		flange depth	circlip required 38005-0100	R-14540 T-35509 38003-0110																																																										
SUBARU EA71 Bore Dia. 92.0 mm 4 cyl. 1,595 cc LEONE ` BRAT (76-87) OHV	KBS95250	LB95250	KB95250	KR95250		length	length 71.5	top 2.0	outside diameter	comp. 32.0 height +0	2nd 2.0 oil 4.0	flange diameter	pin = 21.0 x 82.0 circlip required	N-SWF20-017 R-14200 T-35510			flange depth	38005-4300 38005-4310 38005-4320	38003-4300 38003-4320		SUBARU EA71 New Bore Dia. 92.0 mm 4 cyl. 1,595 cc LEONE ` BRAT (76-87) OHV	KBS95260	LB95260	KB95260	KR95260		length	length 71.1	top 1.2	outside diameter	comp. 31.6 height +0	2nd 1.5 oil 4.0	flange diameter	pin = 21.0 x 82.0 circlip required	N-SWF20-039/057 R-14070 / 14510 T-35517			flange depth	48005-7100	12033-AA000 12033-AA330 48003-7100																						
						length	length 71.5	top 2.0																																																						
						outside diameter	comp. 32.0 height +0	2nd 2.0 oil 4.0																																																						
						flange diameter	pin = 21.0 x 82.0 circlip required	N-SWF20-017 R-14200 T-35510																																																						
		flange depth	38005-4300 38005-4310 38005-4320	38003-4300 38003-4320																																																										
SUBARU EA71 New Bore Dia. 92.0 mm 4 cyl. 1,595 cc LEONE ` BRAT (76-87) OHV	KBS95260	LB95260	KB95260	KR95260		length	length 71.1	top 1.2	outside diameter	comp. 31.6 height +0	2nd 1.5 oil 4.0	flange diameter	pin = 21.0 x 82.0 circlip required	N-SWF20-039/057 R-14070 / 14510 T-35517			flange depth	48005-7100	12033-AA000 12033-AA330 48003-7100																																											
						length	length 71.1	top 1.2																																																						
						outside diameter	comp. 31.6 height +0	2nd 1.5 oil 4.0																																																						
						flange diameter	pin = 21.0 x 82.0 circlip required	N-SWF20-039/057 R-14070 / 14510 T-35517																																																						
		flange depth	48005-7100	12033-AA000 12033-AA330 48003-7100																																																										

SUBARU

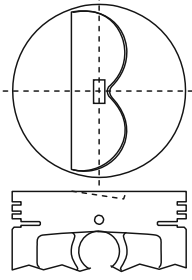
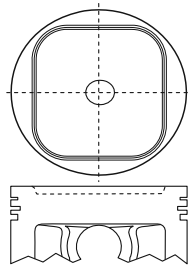
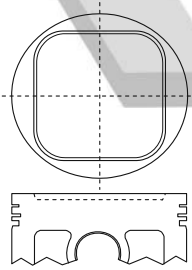
MOTOR - TYP	KOLBEN + RINGE PISTON + RINGS PISTONES + ANILLOS	LAUFBUCHSE CYL. SLEEVE CAMISAS	KOLBENSATZ PISTON SET PISTONES KIT	RINGSATZ RING SET ANILLOS	KOLBEN PISTON PISTONES	
SUBARU EA82 (L/R) Bore Dia. 92.0 mm 4 cyl. 1,781 cc ALCYONE LEONE XT (84-94) SOHC	KBS95270	LB95270 length outside diameter flange diameter flange depth	KB95270 length 65.0 comp. height 31.5 +0	KR95270 top 2.0 2nd 2.0 oil 4.0		
			pin = 21.0 x 70.0 circlip required	N-SWF20-017 R-14200 T-35510		
			12013-AA030	38003-4300 38003-4320		
SUBARU EJ20T Bore Dia. 92.0 mm 4 cyl. 1,994 cc IMPREZA LEGACY (89-00) 16V	KBS72000	LB72000 length outside diameter flange diameter flange depth	KB72000 length 54.1 comp. height 33.3 -3.6	KR72000 top 1.5 2nd 1.5 oil 3.0		
			head, top and 2nd ring lands anodized skirt MOS2 treated	pin = 23.0 x 62.0 circlip required		N-SWF20-044 R- T-
				12006-AA630		12033-AA610
SUBARU EJ20T Bore Dia. 92.0 mm 4 cyl. 1,994 cc IMPREZA LEGACY (89-00) 16V	KBS72001	LB72001 length outside diameter flange diameter flange depth	KB72001 length 54.1 comp. height 33.3 -3.5	KR72001 top 1.2 2nd 1.5 oil 3.0		
			head, top and 2nd ring lands anodized skirt MOS2 treated	pin = 23.0 x 62.0 circlip required		N-SWF20-051 R-14241 T-
						12033-AA510 12033-AA604

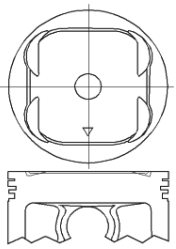
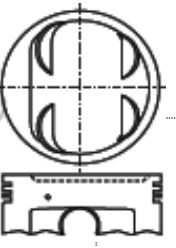
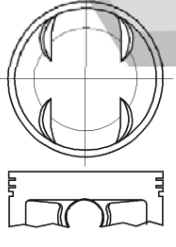
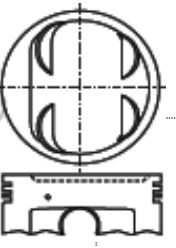
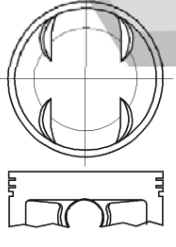
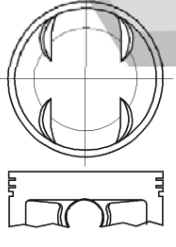
MOTOR - TYP	KOLBEN + RINGE PISTON + RINGS PISTONES + ANILLOS	LAUFBUCHSE CYL. SLEEVE CAMISAS	KOLBENSATZ PISTON SET PISTONES KIT	RINGSATZ RING SET ANILLOS	KOLBEN PISTON PISTONES																																																																																				
SUBARU EJ20 Bore Dia. 92.0 mm 4 cyl. 1,994 cc IMPREZA LEGACY (89-00) 16V	KBS72002	LB72002	KB72002	KR72001		skirt MOS2 treated	length	length 54.1	top 1.2		outside diameter	comp. height 33.3 -1.5	2nd 1.5		flange diameter	pin = 23.0 x 58.0 circlip required	oil 3.0			flange depth	12006-AA380	N-SWF20-051 R-14241 T-						12033-AA510 12033-AA604		SUBARU EJ22 (L/R) Bore Dia. 96.9 mm 4 cyl. 2,212 cc IMPREZA LEGACY (89-01) SOHC 16V	KBS81500	LB81500	KB81500	KR81500			length	length 68.1	top 1.2		outside diameter	comp. height 33.3 -2.6	2nd 1.5		flange diameter	pin = 23.0 x 58.0 circlip required	oil 3.0			flange depth	12018-AA231(L) 12013-AA231(R)	N-SWF20-045 R-14365 T-						12033-AA210		SUBARU EJ25 Bore Dia. 99.5 mm 4 cyl. 2,457 cc IMPREZA (98-) SOHC 16V	KBS70000	LB70000	KB70000	KR70000		skirt MOS2 treated	length	length 50.0	top 1.2		outside diameter	comp. height 29.5 -1.7	2nd 1.2		flange diameter	pin = 23.0 x 64.0 circlip required	oil 2.5			flange depth	12006-AB470	N-SWF20-066 R- T-						12033-AB010	
						skirt MOS2 treated	length	length 54.1	top 1.2																																																																																
							outside diameter	comp. height 33.3 -1.5	2nd 1.5																																																																																
							flange diameter	pin = 23.0 x 58.0 circlip required	oil 3.0																																																																																
		flange depth	12006-AA380	N-SWF20-051 R-14241 T-																																																																																					
				12033-AA510 12033-AA604																																																																																					
SUBARU EJ22 (L/R) Bore Dia. 96.9 mm 4 cyl. 2,212 cc IMPREZA LEGACY (89-01) SOHC 16V	KBS81500	LB81500	KB81500	KR81500			length	length 68.1	top 1.2		outside diameter	comp. height 33.3 -2.6	2nd 1.5		flange diameter	pin = 23.0 x 58.0 circlip required	oil 3.0			flange depth	12018-AA231(L) 12013-AA231(R)	N-SWF20-045 R-14365 T-						12033-AA210		SUBARU EJ25 Bore Dia. 99.5 mm 4 cyl. 2,457 cc IMPREZA (98-) SOHC 16V	KBS70000	LB70000	KB70000	KR70000		skirt MOS2 treated	length	length 50.0	top 1.2		outside diameter	comp. height 29.5 -1.7	2nd 1.2		flange diameter	pin = 23.0 x 64.0 circlip required	oil 2.5			flange depth	12006-AB470	N-SWF20-066 R- T-						12033-AB010																															
							length	length 68.1	top 1.2																																																																																
							outside diameter	comp. height 33.3 -2.6	2nd 1.5																																																																																
							flange diameter	pin = 23.0 x 58.0 circlip required	oil 3.0																																																																																
		flange depth	12018-AA231(L) 12013-AA231(R)	N-SWF20-045 R-14365 T-																																																																																					
				12033-AA210																																																																																					
SUBARU EJ25 Bore Dia. 99.5 mm 4 cyl. 2,457 cc IMPREZA (98-) SOHC 16V	KBS70000	LB70000	KB70000	KR70000		skirt MOS2 treated	length	length 50.0	top 1.2		outside diameter	comp. height 29.5 -1.7	2nd 1.2		flange diameter	pin = 23.0 x 64.0 circlip required	oil 2.5			flange depth	12006-AB470	N-SWF20-066 R- T-						12033-AB010																																																													
						skirt MOS2 treated	length	length 50.0	top 1.2																																																																																
							outside diameter	comp. height 29.5 -1.7	2nd 1.2																																																																																
							flange diameter	pin = 23.0 x 64.0 circlip required	oil 2.5																																																																																
		flange depth	12006-AB470	N-SWF20-066 R- T-																																																																																					
				12033-AB010																																																																																					

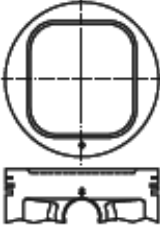
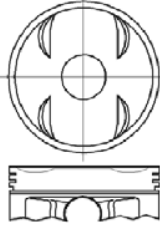
MOTOR - TYP	KOLBEN + RINGE PISTON + RINGS PISTONES + ANILLOS	LAUFBUCHSE CYL. SLEEVE CAMISAS	KOLBENSATZ PISTON SET PISTONES KIT	RINGSATZ RING SET ANILLOS	KOLBEN PISTON PISTONES
SUBARU EJ25 Bore Dia. 99.5 mm 4 cyl. 2,457 cc	KBS70001 skirt MOS2 treated	LB70001 length outside diameter flange diameter flange depth	KB70001 length 51.1 comp. height 30.3 -3.1 pin = 23.0 x 62.0 circlip required	KR70001 top 1.2 2nd 1.5 oil 2.8 N-SWF20-064 R-14355 T- 12006-AB410 12033-AA760	
SUBARU EJ257 Bore Dia. 99.5 mm 4 cyl. 2,457 cc	KBS39500 head, top and 2nd ring lands anodized skirt MOS2 treated	LB39500 length outside diameter flange diameter flange depth	KB39500 length 51.5 comp. height 30.7 -1.8 -5.3 pin = 23.0 x 64.0 circlip required	KR39500 top 1.2 2nd 1.2 oil 2.0 N-SWF20-068 R- T- 12006-AC390 12006-AC400 12006-AC410 12006-AC420 12033-AB340 12033-AC000 12033-AC010 12033-AC020	
		length outside diameter flange diameter flange depth	length comp. height pin = x	top 2nd oil N- R- T-	

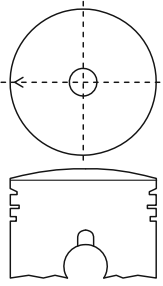
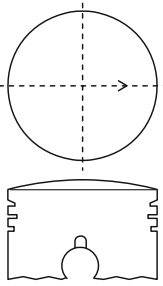
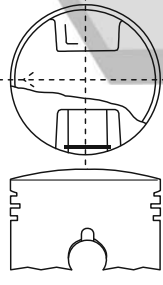
MOTOR - TYP	KOLBEN + RINGE PISTON + RINGS PISTONES + ANILLOS	LAUFBUCHSE CYL. SLEEVE CAMISAS	KOLBENSATZ PISTON SET PISTONES KIT	RINGSATZ RING SET ANILLOS	KOLBEN PISTON PISTONES
SUZUKI L30 L40 Bore Dia. 61.0 mm 2 cyl. 359 cc CARRY TRUCK	KBS95300	LB95300 length outside diameter flange diameter flange depth	KB95300 length 76.2 comp. height 37.2 +4.0 pin = 18.0 x 48.5 circlip required 12110-52301	KR95300 top 2.0 half keystone 2nd 2.0 3rd 2.0 N- R-26450 T-35551 / 35574 12140-61010 12140-63850 12140-67810 12140-67811	
SUZUKI L50 Bore Dia. 61.0 mm 2 cyl. 359 cc CARRY TRUCK	KBS95310	LB95310 length outside diameter flange diameter flange depth	KB95310 length 71.0 comp. height 31.7 +4.3 pin = 16.0 x 52.0 circlip required 12110-67004	KR95310 top 2.0 half keystone 2nd 2.0 3rd 2.0 N- R-26450 T-35551 / 35574 12140-61010 12140-63850 12140-67810 12140-67811	
SUZUKI L50 Bore Dia. 61.0 mm 2 cyl. 359 cc CARRY TRUCK	KBS95311	LB95311 length outside diameter flange diameter flange depth	KB95311 length 71.0 comp. height 32.0 +4.0 pin = 16.0 x 52.0 circlip required 12110-67001	KR95311 top 2.0 half keystone 2nd 2.0 3rd 2.0 N- R-26450 T-35551 / 35574 12140-61010 12140-63850 12140-67810 12140-67811	

SUZUKI

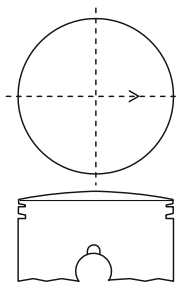
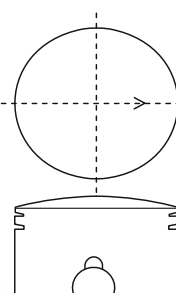
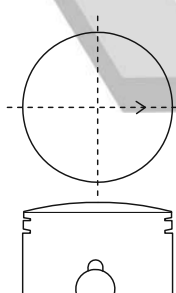
MOTOR - TYP	KOLBEN + RINGE PISTON + RINGS PISTONES + ANILLOS	LAUFBUCHSE CYL. SLEEVE CAMISAS	KOLBENSATZ PISTON SET PISTONES KIT	RINGSATZ RING SET ANILLOS	KOLBEN PISTON PISTONES	
SUZUKI L60 Bore Dia. 68.0 mm 2 cyl. 550 cc	KBS95320	LB95320	length	length 70.9	top 1.2 half keystone	
			outside diameter	comp. height +3.8	2nd 2.0 half keystone	
			flange diameter	pin = 16.0 x 59.0 circlip required	N-SBS20-079 R-26040/ 27540 T-35570	
			flange depth	12110-67101	12140-67820	
SUZUKI LJ50 ST10 LJ50 ST20 Bore Dia. 61.0 mm 3 cyl. 539 cc CARRY TRUCK JIMMY 4WD	KBS95330	LB95330	length	length 71.0	top 1.2 half keystone	
			outside diameter	comp. height +4.0	2nd 2.0 half keystone	
			flange diameter	pin = 16.0 x 52.0 circlip required	N-SBS20-078 R-26010/ 26870 27670 T-35569/ 35579	
			flange depth	12110-67002 12110-72102	12140-63871 12140-67011 12140-67810 12140-68811 12140-72810 12140-72811	
SUZUKI LJ50 ST30 Bore Dia. 61.0 mm 3 cyl. 539 cc CARRY TRUCK JIMMY 4WD	KBS95340	LB95340	length	length 71.0	top 1.2 half keystone	
			outside diameter	comp. height +4.0	2nd 2.0 half keystone	
			flange diameter	pin = 16.0 x 52.0 circlip required	N-SBS20-078 R-26010/ 26870 27670 T-35569/ 35579	
			flange depth	12110-67007	12140-63871 12140-67011 12140-67810 12140-68811 12140-72810 12140-72811	

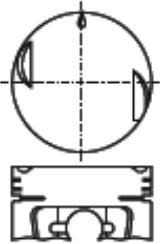
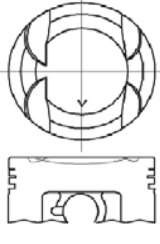
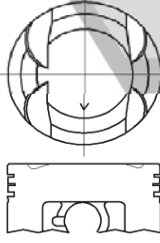
MOTOR - TYP	KOLBEN + RINGE PISTON + RINGS PISTONES + ANILLOS	LAUFBUCHSE CYL. SLEEVE CAMISAS	KOLBENSATZ PISTON SET PISTONES KIT	RINGSATZ RING SET ANILLOS	KOLBEN PISTON PISTONES
SUZUKI F5A Bore Dia. 62.0 mm 3 cyl. 543 cc FRONTE 550	KBS95350	LB95350 length 120.0 outside diameter 66.0 flange diameter flange depth	KB95350 length 57.5 comp. height 27.5 +0 pin = 16.0 x 50.0 circlip required 12111-78110 12111-78111	KR95350 top 1.5 2nd 1.5 oil 2.8 N-SWS20-138 R-26220 / 27220 T-35572 12140-73000 12140-73010 12140-73011	
SUZUKI F6A Bore Dia. 65.0 mm 3 cyl. 657 cc ALUT CELVO	KBS95360	LB95360 length outside diameter flange diameter flange depth	KB95360 length 52.5 comp. height 25.5 -0.5 -2.7 pin = 16.0 x 49.5 circlip required 12111-51E00	KR95360 top 1.2 2nd 1.5 oil 2.5 N-SWS20-128 R-13313 / 26313 26015 T-35582 12140-51E50 12140-73D00	
SUZUKI F6A Bore Dia. 65.0 mm 3 cyl. 657 cc	KBS95361	LB95361 length outside diameter flange diameter flange depth	KB95361 length 52.5 comp. height 25.5 -0.5 pin = 16.0 x 49.0 circlip required 12111-71G00	KR95361 top 1.0 2nd 1.2 oil 2.0 N- R- T- 12140-70G00	

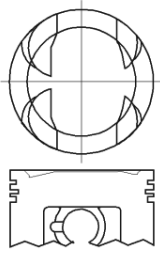
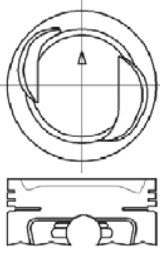
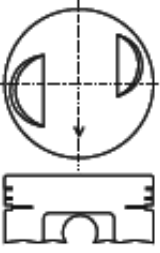
MOTOR - TYP	KOLBEN + RINGE PISTON + RINGS PISTONES + ANILLOS	LAUFBUCHSE CYL. SLEEVE CAMISAS	KOLBENSATZ PISTON SET PISTONES KIT	RINGSATZ RING SET ANILLOS	KOLBEN PISTON PISTONES
SUZUKI F6A Bore Dia. 65.0 mm 3 cyl. 657 cc ALUT CELVO	KBS95362	LB95362 length outside diameter flange diameter flange depth	KB95362	KR95362	
			length 52.6	top 1.2	
			comp. height 25.6 -0.7	2nd 1.5 oil 2.5	
			pin = 16.0 x 50.0 circlip required 12111-86050	N-SWS20-128 R-13313 / 26015 26313 T-35582 12140-51E50 12140-73D00	
SUZUKI F8B Bore Dia. 68.5 mm 3 cyl. 796 cc ALTO FRONTE	KBS95370	LB95370 length 160.0 outside diameter 72.5 flange diameter flange depth	KB95370	KR95370	
			length 55.0	top 1.5	
			comp. height 25.0 -3.0	2nd 1.5 oil 2.8	
			pin = 16.0 x 53.5 circlip required 12110-78400 12110-78402 12111-78400 12111-78402	N-SWS20-120 R-26856 / 26910 T-35586 12140-78410 12140-78411 12140-78412	
SUZUKI G10 Bore Dia. 74.0 mm 3 cyl. 993 cc CALTUS	KBS95380	LB95380 length 140.0 outside diameter 78.0 flange diameter flange depth	KB95380	KR95380	
			length 55.3	top 1.2	
			comp. height 28.3 +0	2nd 1.5 oil 2.8	
			pin = 17.0 x 62.0 circlip not required 12111-82010	N-SWS20-131 R-26060 / 26070 T-35580 / 35584 12140-82001 12140-82050 12140-82051 12140-82161	

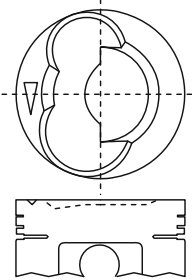
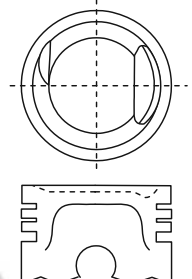
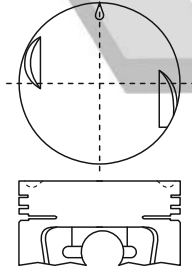
MOTOR - TYP	KOLBEN + RINGE PISTON + RINGS PISTONES + ANILLOS	LAUFBUCHSE CYL. SLEEVE CAMISAS	KOLBENSATZ PISTON SET PISTONES KIT	RINGSATZ RING SET ANILLOS	KOLBEN PISTON PISTONES
SUZUKI G10 G10A Bore Dia. 74.0 mm 3 cyl. 993 cc CALTUS	KBS95390	LB95390 length 140.0 outside diameter 78.0 flange diameter flange depth	KB95390 length 55.7 comp. height 28.7 -1.9 -3.7 pin = 17.0 x 65.0 circlip not required 12100-61810 12111-60B00 12111-60B50 12111-61810	KR95390 top 1.2 2nd 1.5 oil 2.8 N-SWS20-131 R-26060/ 26070 T-35580/ 35584 12140-82001 12140-82050 12140-82051 12140-82161	
SUZUKI G10T Bore Dia. 74.0 mm 3 cyl. 993 cc CALTUS	KBS95400	LB95400 length 140.0 outside diameter 78.0 flange diameter flange depth	KB95400 length 55.3 comp. height 28.3 -1.3 pin = 19.0 x 62.0 circlip required 12111-82152	KR95400 top 1.2 2nd 1.5 oil 2.8 N-SWS20-131 R-26060/ 26070 T-35580/ 35584 12140-82001 12140-82050 12140-82051 12140-82161	
SUZUKI F8A Bore Dia. 62.0 mm 4 cyl. 797 cc JIMMY CARRY TRUCK ST90	KBS95410	LB95410 length 120.0 outside diameter 66.0 flange diameter flange depth	KB95410 length 57.5 comp. height 27.5 +0 pin = 16.0 x 50.0 circlip required 12111-78110 12111-78111	KR95410 top 1.5 2nd 1.5 oil 2.8 N-SWS20-098 R-26220/ 26866 T-35573 12140-73000 12140-73010 12140-73011	

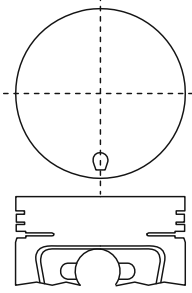
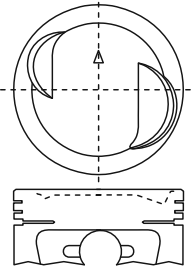
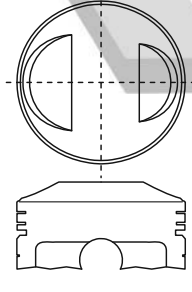

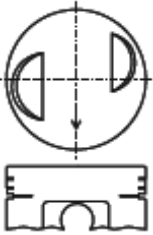
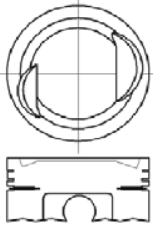
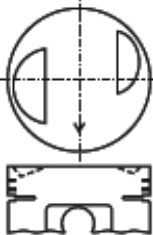
MOTOR - TYP	KOLBEN + RINGE PISTON + RINGS PISTONES + ANILLOS	LAUFBUCHSE CYL. SLEEVE CAMISAS	KOLBENSATZ PISTON SET PISTONES KIT	RINGSATZ RING SET ANILLOS	KOLBEN PISTON PISTONES
SUZUKI F8A Bore Dia. 62.0 mm 4 cyl. 797 cc	KBS95411	LB95411 length 120.0 outside diameter 66.0 flange diameter flange depth	KB95411 length 57.5 comp. height 27.5 +0 pin = 16.0 x 50.0 circlip required	KR95411 top 1.5 2nd 1.5 oil 2.8 N-SWS20-098 R-26220/ 26866 T-35573	
JIMMY CARRY TRUCK ST90					
SUZUKI F10A Bore Dia. 65.5 mm 4 cyl. 970 cc	KBS95420	LB95420 length 125.0 outside diameter 69.5 flange diameter flange depth	KB95420 length 55.0 comp. height 24.5 -2.0 pin = 16.0 x 53.5 circlip required	KR95420 top 1.5 2nd 1.5 oil 2.8 N-SWS20-106 R-26020/ 26030 26868 T-35576/ 35585	
ALUT JIMMY SJ410					
SUZUKI G10 Bore Dia. 72.0 mm 4 cyl. 993 cc	KBS95430	LB95430 length outside diameter flange diameter flange depth	KB95430 length 75.3 comp. height 25.6 +8.0 pin = 18.0 x 55.0 circlip not required	KR95430 top 1.5 2nd 1.5 oil 2.8 N- R- T-	

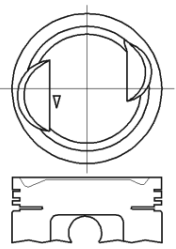
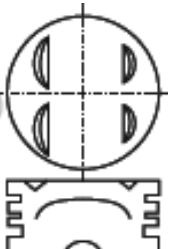
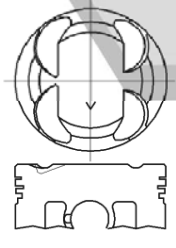
MOTOR - TYP	KOLBEN + RINGE PISTON + RINGS PISTONES + ANILLOS	LAUFBUCHSE CYL. SLEEVE CAMISAS	KOLBENSATZ PISTON SET PISTONES KIT	RINGSATZ RING SET ANILLOS	KOLBEN PISTON PISTONES	
SUZUKI G13 Bore Dia. 74.0 mm 4 cyl. 1,298 cc CALTAS SWIFT	KBS95440	LB95440 length 140.0 outside diameter 78.0 flange diameter flange depth	KB95440 length 55.3 comp. height 28.3 +0 pin = 17.0 x 65.0 circlip not required	KR95440 top 1.2 2nd 1.5 oil 2.8 N-SWS20-141 R-26070/ 26090 26492 T-33580/ 33587 35614 12140-82050 12140-82051 12140-82X50		
						12111-82010
SUZUKI G13 G13A Bore Dia. 74.0 mm 4 cyl. 1,298 cc CALTAS SWIFT	KBS95450	LB95450 length 140.0 outside diameter 78.0 flange diameter flange depth	KB95450 length 55.4 comp. height 28.4 -1.3 -5.3 pin = 17.0 x 65.0 circlip not required	KR95450 top 1.2 2nd 1.5 oil 2.8 N-SWS20-141 R-26070/ 26090 26492 T-33580/ 33587 35614 12140-82050 12140-82051 12140-82X50		
						12111-83000
SUZUKI G13 Bore Dia. 74.0 mm 4 cyl. 1,298 cc CALTAS SWIFT	KBS95460	LB95460 length 140.0 outside diameter 78.0 flange diameter flange depth	KB95460 length 56.2 comp. height 29.3 +0 pin = 17.0 x 65.0 circlip not required	KR95460 top 1.2 2nd 1.5 oil 2.8 N-SWS20-141 R-26070/ 26090 26492 T-33580/ 33587 35614 12140-82050 12140-82051 12140-82X50		
						12111-63B00

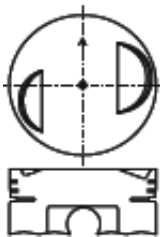
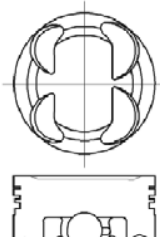
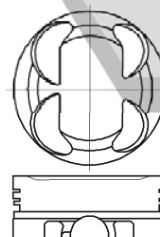
MOTOR - TYP	KOLBEN + RINGE PISTON + RINGS PISTONES + ANILLOS	LAUFBUCHSE CYL. SLEEVE CAMISAS	KOLBENSATZ PISTON SET PISTONES KIT	RINGSATZ RING SET ANILLOS	KOLBEN PISTON PISTONES	
SUZUKI G13 Bore Dia. 74.0 mm 4 cyl. 1,298 cc CALTAS SWIFT SF413	KBS95470	LB95470 length 140.0 outside diameter 78.0 flange diameter flange depth	KB95470 length 56.4 comp. height 29.5 -1.2 pin = 17.0 x 65.0 circlip not required	KR95470 top 1.2 2nd 1.5 oil 2.8 N-SWS20-141 R-26070/ 26090 26492 T-33580/ 33587 35614 12140-82050 12140-82051 12140-82X50		
						12111-63B50
SUZUKI G13 G13B Bore Dia. 74.0 mm 4 cyl. 1,298 cc CALTS SWIFT	KBS95480	LB95480 length 140.0 outside diameter 78.0 flange diameter flange depth	KB95480 length 56.1 comp. height 29.1 +0 pin = 19.0 x 62.0 circlip required	KR95480 top 1.2 2nd 1.5 oil 2.8 N-SWS20-141 R-26070/ 26090 26492 T-33580/ 33587 35614 12140-82050 12140-82051 12140-82X50		
						12111-86501
SUZUKI G13 G13A Bore Dia. 74.0 mm 4 cyl. 1,298 cc SWIFT Y58	KBS95490	LB95490 length 140.0 outside diameter 78.0 flange diameter flange depth	KB95490 length 56.1 comp. height 29.1 -1.8 pin = 19.0 x 63.0 circlip required	KR95490 top 1.2 2nd 1.2 oil 2.5 N-SWS20-186 R-26025 T-35598 12140-63E50		
						12111-63E10

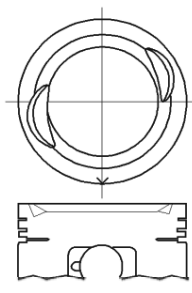
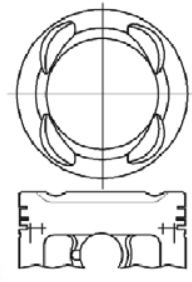
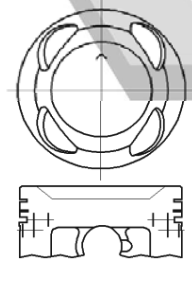
MOTOR - TYP	KOLBEN + RINGE PISTON + RINGS PISTONES + ANILLOS	LAUFBUCHSE CYL. SLEEVE CAMISAS	KOLBENSATZ PISTON SET PISTONES KIT	RINGSATZ RING SET ANILLOS	KOLBEN PISTON PISTONES
SUZUKI G13 G13B Bore Dia. 74.0 mm 4 cyl. 1,298 cc CALTS SWIFT	KBS95500	LB95500 length 140.0 outside diameter 78.0 flange diameter flange depth	KB95500 length 56.2 comp. height 29.2 +0 pin = 17.0 x 65.0 circlip not required 12100-61840	KR95500	
				top 1.2 2nd 1.5 oil 2.8	
				N-SWS20-141 R-26070/ 26090 26492 T-33580/ 33587 35614	
				12140-82050 12140-82051 12140-82X50	
SUZUKI G13BB Bore Dia. 74.0 mm 4 cyl. 1,298 cc CALTS SWIFT DOHC 16V	KBS47000	LB47000 length 140.0 outside diameter 78.0 flange diameter flange depth	KB47000 length 56.0 comp. height 29.0 -1.9 pin = 19.0 x 56.0 circlip required	KR47000	
				top 1.2 2nd 1.5 oil 2.8	
				N-SWS20-141 R-26070/ 26090 26492 T-33580/ 33587 35614	
				12140-82050 12140-82051 12140-82X50	
SUZUKI G13BB Bore Dia. 74.0 mm 4 cyl. 1,298 cc CALTS SWIFT DOHC 16V	KBS47001	LB47001 length 140.0 outside diameter 78.0 flange diameter flange depth	KB47001 length 56.0 comp. height 29.0 -1.8 -5.1 pin = 19.0 x 63.0 circlip required 12100-63880	KR47001	
				top 1.2 2nd 1.2 oil 2.5	
				N-SWS20-186 R-26025 T-35598	
				12140-63E50	

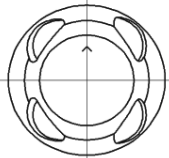
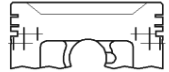
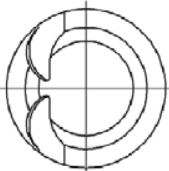
MOTOR - TYP	KOLBEN + RINGE PISTON + RINGS PISTONES + ANILLOS	LAUFBUCHSE CYL. SLEEVE CAMISAS	KOLBENSATZ PISTON SET PISTONES KIT	RINGSATZ RING SET ANILLOS	KOLBEN PISTON PISTONES
SUZUKI G16 G16A Bore Dia. 75.0 mm 4 cyl. 1,590 cc ESCUDO 8V	KBS95510	LB95510 length 138.0 outside diameter 79.0 flange diameter flange depth	KB95510	KR95510	
			length 58.3 comp. height 28.3 -3.3	top 1.2 2nd 1.5 oil 2.8	
			pin = 19.0 x 61.5 circlip required	N-SWS20-142 R-26110/ 26140 26251 T-35583	
			12111-60A00 12111-60A02	12140-60A50 12140-61A00	
SUZUKI G16 G16B Bore Dia. 75.0 mm 4 cyl. 1,590 cc ESCUDO 16V	KBS95520	LB95520 length 138.0 outside diameter 79.0 flange diameter flange depth	KB95520	KR95520	
			length 55.2 comp. height 28.2 -4.1	top 1.2 2nd 1.5 oil 2.8	
			pin = 19.0 x 61.5 circlip required	N-SWS20-142 R-26110/ 26140 26251 T-35583	
			12100-71820	12140-60A50 12140-61A00	
SUZUKI G16 Bore Dia. 75.0 mm 4 cyl. 1,590 cc ESCUDO	KBS95530	LB95530 length 138.0 outside diameter 79.0 flange diameter flange depth	KB95530	KR95530	
			length 55.3 comp. height 28.3 -6.0	top 1.2 2nd 1.5 oil 2.8	
			pin = 19.0 x 62.0 circlip required	N-SWS20-142 R-26110/ 26140 26251 T-35583	
			12111-71C51	12140-60A50 12140-61A00	

MOTOR - TYP	KOLBEN + RINGE PISTON + RINGS PISTONES + ANILLOS	LAUFBUCHSE CYL. SLEEVE CAMISAS	KOLBENSATZ PISTON SET PISTONES KIT	RINGSATZ RING SET ANILLOS	KOLBEN PISTON PISTONES
SUZUKI G16 Bore Dia. 75.0 mm 4 cyl. 1,590 cc ESCUDO	KBS95531	LB95531 length 138.0 outside diameter 79.0 flange diameter flange depth	KB95531 length 55.3 comp. height 28.3 -6.1 pin = 19.0 x 62.0 circlip not required	KR95531 top 1.2 2nd 1.5 oil 2.8	 
SUZUKI M13A Bore Dia. 78.0 mm 4 cyl. 1,328 cc SWIFT RS413 (04-) DOHC 16V	KBS36500 skirt MOS2 treated	LB36500 length outside diameter flange diameter flange depth	KB36500 length 59.5 comp. height 29.4 -1.9 -4.2 pin = 20.0 x 58.0 circlip required	KR36500 top 1.2 2nd 1.2 oil 2.5	 
SUZUKI M15A Bore Dia. 78.0 mm 4 cyl. 1,490 cc SWIFT SX4 RS415 RW415 (04-) DOHC 16V	KBS37500	LB37500 length outside diameter flange diameter flange depth	KB37500 length comp. height pin = x circlip required	KR37500 top 1.2 2nd 1.2 oil 2.5	

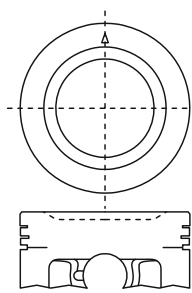
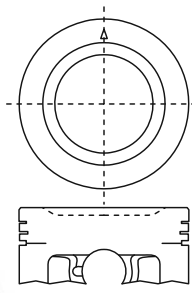
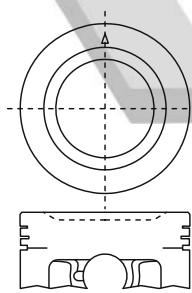
MOTOR - TYP	KOLBEN + RINGE PISTON + RINGS PISTONES + ANILLOS	LAUFBUCHSE CYL. SLEEVE CAMISAS	KOLBENSATZ PISTON SET PISTONES KIT	RINGSATZ RING SET ANILLOS	KOLBEN PISTON PISTONES
SUZUKI J20A Bore Dia. 84.0 mm 4 cyl. 1,995 cc	KBS36000	LB36000 length 135.0 outside diameter 88.0 flange diameter flange depth	KB36000 length 58.9 comp. height 29.4 -4.9 pin = 21.0 x 59.0 circlip required 12100-65810 12100-65811	KR36000 top 1.2 2nd 1.5 oil 2.5 N- R- T- 12140-77E00 12140-86FA0	
SUZUKI H20A Bore Dia. 78.0 mm 6 cyl. 1,998 cc VITARA SV620 (94-98) DOHC 24V	KBS95560	LB95560 length 110.0 outside diameter 82.0 flange diameter flange depth	KB95560 length 58.9 comp. height 29.4 -3.2 pin = 20.0 x 57.7 circlip required 12111-8JFA1	KR95560 top 1.2 2nd 1.5 oil 2.5 N- R- T-35610 12140-85FA0	
SUZUKI H25A Bore Dia. 84.0 mm 6 cyl. 2,493 cc	KBS95570	LB95570 length 135.0 outside diameter 88.0 flange diameter flange depth	KB95570 length 58.9 comp. height 29.4 -4.9 pin = 21.0 x 57.5 circlip required 12100-86830 12100-86831 12111-86FA1	KR95570 top 1.2 2nd 1.5 oil 2.5 N- R- T- 12140-77E00 12140-86FA0	

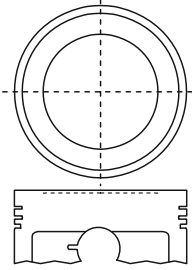

MOTOR - TYP	KOLBEN + RINGE PISTON + RINGS PISTONES + ANILLOS	LAUFBUCHSE CYL. SLEEVE CAMISAS	KOLBENSATZ PISTON SET PISTONES KIT	RINGSATZ RING SET ANILLOS	KOLBEN PISTON PISTONES
SUZUKI H27A Bore Dia. 88.0 mm 6 cyl. 2,736 cc	KBS38500	LB38500	KB38500	KR38500	
	head, top and 2nd ring lands anodized	length 138.0 outside diameter 92.0 flange diameter flange depth	length 58.8 comp. height 29.3 -4.8 pin = 21.0 x 58.7 circlip required 12100-52810-025 12100-52811-025 12100-52811-050 12100-52812-050 12100-52811-0A0 12100-52811-0B0 12100-52812-0A0 12100-52812-0B0	top 1.2 2nd 1.5 oil 2.8 N- R-26160 T-35627 12140-52D00	
GRAND VITARA XL-7 JA627 (00-) DOHC 24V					
		length outside diameter flange diameter flange depth	length comp. height pin = x	top 2nd oil N- R- T-	
		length outside diameter flange diameter flange depth	length comp. height pin = x	top 2nd oil N- R- T-	

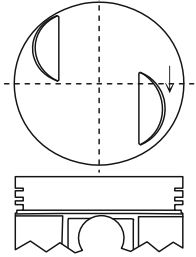

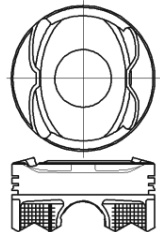
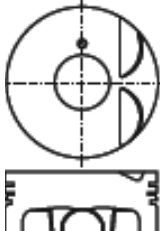
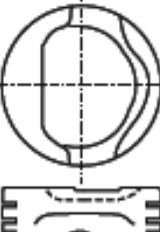
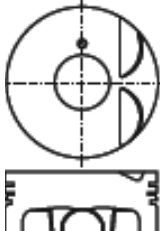
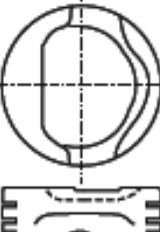
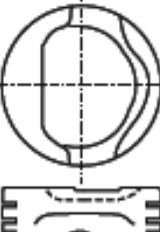
MOTOR - TYP	KOLBEN + RINGE PISTON + RINGS PISTONES + ANILLOS	LAUFBUCHSE CYL. SLEEVE CAMISAS	KOLBENSATZ PISTON SET PISTONES KIT	RINGSATZ RING SET ANILLOS	KOLBEN PISTON PISTONES			
TATA 1.4 MPEI Bore Dia. 75.0 mm 4 cyl. 1,405 cc INDICA (04-) DOHC 8V	KBS95580	LB95580	KB95580	KR95580				
						length	length 52.5	top 1.2
						outside diameter	comp. height 27.5 -3.0	2nd 1.5 oil 2.8
						flange diameter	pin = 20.0 x 59.1 circlip not required	N- R- T-
flange depth								
		length	length	top				
		outside diameter	comp. height	2nd				
		flange diameter	pin = x	oil				
		flange depth		N- R- T-				
		length	length	top				
		outside diameter	comp. height	2nd				
		flange diameter	pin = x	oil				
		flange depth		N- R- T-				

MOTOR - TYP	KOLBEN + RINGE PISTON + RINGS PISTONES + ANILLOS	LAUFBUCHSE CYL. SLEEVE CAMISAS	KOLBENSATZ PISTON SET PISTONES KIT	RINGSATZ RING SET ANILLOS	KOLBEN PISTON PISTONES																																																							
TOYOTA 1KR-FE Bore Dia. 71.0 mm 3 cyl. 998 cc AYGO PASSO VITZ YARIS KGB10 KSP90 (05-) DOHC 12V	KBS97000	LB97000	KB97000	KR97000		skirt MOS2 treated	length	length 47.05	top 1.0	outside diameter	comp. height 29.25 -3.0 -6.3	2nd 1.0 oil 1.5	flange diameter	pin = 18.0 x 47.0 circlip not required	N- R- T-	flange depth	13101-40020 13101-40021	13011-0Q010 13011-40030	TOYOTA 1SZ-FE Bore Dia. 69.0 mm 4 cyl. 997 cc ECHO VITZ YARIS SCP10 (99- 02) DOHC 16V	KBS10500	LB10500	KB10500	KR10500		length	length 44.0	top 1.2	outside diameter	comp. height 26.0 +0.2 -2.2	2nd 1.2 oil 2.0	flange diameter	pin = 18.0 x 47.2 circlip not required	N-SWT10-201 R-28067 T-	flange depth	13101-23020 13103-23020	13011-23040 13011-23041 13011-23051 13013-23040 13013-23041	TOYOTA 1E 1E-L Bore Dia. 70.5 mm 4 cyl. 999 cc STARLET EP70 EP80 (84-92) SOHC 12V	KBS95600	LB95600	KB95600	KR95600		length 132.0	length 56.0	top 1.5	outside diameter 74.5	comp. height 28.0 -4.7	2nd 1.5 oil 3.0	flange diameter	pin = 18.0 x 59.0 circlip not required	N-SWT10-104 R-28035 T-35878	flange depth	13101-10033 13103-10033	13011-10070 13011-10071 13011-10072 13011-10080 13011-10081 13012-10070 13013-10070 13013-10071 13013-10072 13013-10081			11461-10080			
							skirt MOS2 treated	length	length 47.05	top 1.0																																																		
								outside diameter	comp. height 29.25 -3.0 -6.3	2nd 1.0 oil 1.5																																																		
						flange diameter		pin = 18.0 x 47.0 circlip not required	N- R- T-																																																			
flange depth	13101-40020 13101-40021	13011-0Q010 13011-40030																																																										
TOYOTA 1SZ-FE Bore Dia. 69.0 mm 4 cyl. 997 cc ECHO VITZ YARIS SCP10 (99- 02) DOHC 16V	KBS10500	LB10500	KB10500	KR10500		length	length 44.0	top 1.2	outside diameter	comp. height 26.0 +0.2 -2.2	2nd 1.2 oil 2.0	flange diameter	pin = 18.0 x 47.2 circlip not required	N-SWT10-201 R-28067 T-	flange depth	13101-23020 13103-23020	13011-23040 13011-23041 13011-23051 13013-23040 13013-23041	TOYOTA 1E 1E-L Bore Dia. 70.5 mm 4 cyl. 999 cc STARLET EP70 EP80 (84-92) SOHC 12V	KBS95600	LB95600	KB95600	KR95600		length 132.0	length 56.0	top 1.5	outside diameter 74.5	comp. height 28.0 -4.7	2nd 1.5 oil 3.0	flange diameter	pin = 18.0 x 59.0 circlip not required	N-SWT10-104 R-28035 T-35878	flange depth	13101-10033 13103-10033	13011-10070 13011-10071 13011-10072 13011-10080 13011-10081 13012-10070 13013-10070 13013-10071 13013-10072 13013-10081			11461-10080																						
							length	length 44.0	top 1.2																																																			
								outside diameter	comp. height 26.0 +0.2 -2.2	2nd 1.2 oil 2.0																																																		
						flange diameter		pin = 18.0 x 47.2 circlip not required	N-SWT10-201 R-28067 T-																																																			
flange depth	13101-23020 13103-23020	13011-23040 13011-23041 13011-23051 13013-23040 13013-23041																																																										
TOYOTA 1E 1E-L Bore Dia. 70.5 mm 4 cyl. 999 cc STARLET EP70 EP80 (84-92) SOHC 12V	KBS95600	LB95600	KB95600	KR95600		length 132.0	length 56.0	top 1.5	outside diameter 74.5	comp. height 28.0 -4.7	2nd 1.5 oil 3.0	flange diameter	pin = 18.0 x 59.0 circlip not required	N-SWT10-104 R-28035 T-35878	flange depth	13101-10033 13103-10033	13011-10070 13011-10071 13011-10072 13011-10080 13011-10081 13012-10070 13013-10070 13013-10071 13013-10072 13013-10081			11461-10080																																								
							length 132.0	length 56.0	top 1.5																																																			
								outside diameter 74.5	comp. height 28.0 -4.7	2nd 1.5 oil 3.0																																																		
						flange diameter		pin = 18.0 x 59.0 circlip not required	N-SWT10-104 R-28035 T-35878																																																			
flange depth	13101-10033 13103-10033	13011-10070 13011-10071 13011-10072 13011-10080 13011-10081 13012-10070 13013-10070 13013-10071 13013-10072 13013-10081																																																										
		11461-10080																																																										

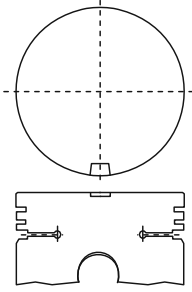
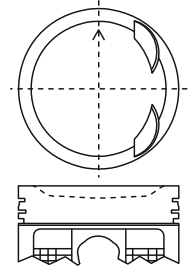
TOYOTA

MOTOR - TYP	KOLBEN + RINGE PISTON + RINGS PISTONES + ANILLOS	LAUFBUCHSE CYL. SLEEVE CAMISAS	KOLBENSATZ PISTON SET PISTONES KIT	RINGSATZ RING SET ANILLOS	KOLBEN PISTON PISTONES
TOYOTA 2K Bore Dia. 72.0 mm 4 cyl. 993 cc PUBLICA STARLET TOYOTA1000 KP3# KP36 KP60 (69-88) OHV 8V	KBS95610	LB95610	KB95610	KR95610	
		length 122.2 outside diameter 76.0 flange diameter flange depth	length 72.1 comp. height 36.0 +0 pin = 18.0 x 58.2 circlip required 13101-12010 13102-12010 13103-12010 13104-12010 13105-12010	top 2.0 2nd 2.0 oil 4.0 N-SWT10-029 R-28590 T-35823 13011-12010/30/31 13012-12010/30/31 13013-12010/30/31 13014-12010/30/31 13015-12010/30/31	
TOYOTA 2SZ-FE Bore Dia. 72.0 mm 4 cyl. 1,296 cc YARIS SCP90 (05-) DOHC 16V	KBS26500	LB26500	KB26500	KR26500	
		length outside diameter flange diameter flange depth	length 46.2 comp. height 28.2 -2.7 -4.05 pin = 18.0 x 48.0 circlip not required 13101-03020 13103-03020 13101-0J020	top 1.2 2nd 1.2 oil 2.0 N- R- T- 13011-23060 13013-23060	
TOYOTA 3SZ-FE Bore Dia. 72.0 mm 4 cyl. 1,495 cc AVANZA F602 (06-) DOHC 16V	KBS95620	LB95620	KB95620	KR95620	
	head anodized skirt MOS2 treated	length outside diameter flange diameter flange depth	length 45.5 comp. height 28.0 -6.7 pin = 18.0 x 54.0 circlip not required 13101-BZ100 13101-BZ140 13101-BZ170 13103-BZ020	top 1.2 2nd 1.2 oil 2.0 N- R- T-31055 13011-BZ110 13013-BZ020	

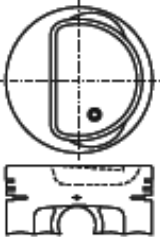
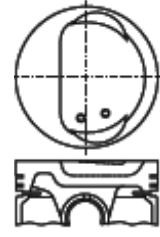
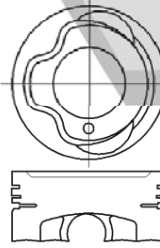
MOTOR - TYP	KOLBEN + RINGE PISTON + RINGS PISTONES + ANILLOS	LAUFBUCHSE CYL. SLEEVE CAMISAS	KOLBENSATZ PISTON SET PISTONES KIT	RINGSATZ RING SET ANILLOS	KOLBEN PISTON PISTONES
TOYOTA 2E Bore Dia. 73.0 mm 4 cyl. 1,295 cc COROLLA CORSA SPRINTER STARLET TAZZ EE80/90/97 EP71 (84-92) SOHC 12V	KBS95630	LB95630 length 138.0 outside diameter 77.0 flange diameter flange depth 11461-11030 11461-11050	KB95630 length 58.0 comp. height 30.0 -9.3 pin = 18.0 x 59.0 circlip not required 13101-11050 13101-11051	KR95630 top 1.5 2nd 1.5 oil 3.0 N-SWT10-105/143 R-28012/ 28971 T-35879/ 35883 35919 13011-11040/41 13011-11060/61 13011-11062/64 13011-11072/80 13011-11090 13012-11060 13013-11060/61 13013-11062/63 13013-11080/90	
TOYOTA 2E Bore Dia. 73.0 mm 4 cyl. 1,295 cc STARLET EP71 EP81 (84-96) SOHC 12V	KBS95640	LB95640 length 138.0 outside diameter 77.0 flange diameter flange depth 11461-11030 11461-11050	KB95640 length 58.0 comp. height 30.0 -7.7 pin = 18.0 x 59.0 circlip not required 13101-11030 13101-11090 13102-11030 13103-11030 13103-11090	KR95640 top 1.5 2nd 1.5 oil 3.0 N-SWT10-105/143 R-28012/ 28971 T-35879/ 35883 35919 13011-11040/41 13011-11060/61 13011-11062/64 13011-11072/80 13011-11090 13012-11060 13013-11060/61 13013-11062/63 13013-11080/90	
TOYOTA 3E 3E-E Bore Dia. 73.0 mm 4 cyl. 1,456 cc TERCEL EL EL31 EL42 (86-94) SOHC 12V	KBS95650	LB95650 length 138.0 outside diameter 77.0 flange diameter flange depth 11461-11030 11461-11050	KB95650 length 62.0 comp. height 30.0 -2.9 pin = 18.0 x 59.0 circlip not required 13101-11080 13101-11081 13103-11080 13103-11081	KR95650 top 1.5 2nd 1.5 oil 3.0 N-SWT10-105/143 R-28012/ 28971 T-35879/ 35883 35919 13011-11040/41 13011-11060/61 13011-11062/64 13011-11072/80 13011-11090 13012-11060 13013-11060/61 13013-11062/63 13013-11080/90	

TOYOTA

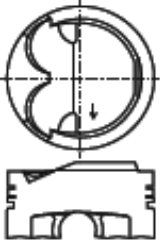
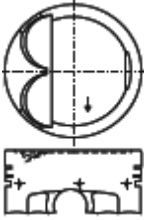
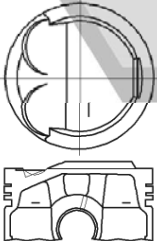
MOTOR - TYP	KOLBEN + RINGE PISTON + RINGS PISTONES + ANILLOS	LAUFBUCHSE CYL. SLEEVE CAMISAS	KOLBENSATZ PISTON SET PISTONES KIT	RINGSATZ RING SET ANILLOS	KOLBEN PISTON PISTONES
TOYOTA 4E-FE Bore Dia. 74.0 mm 4 cyl. 1,331 cc	KBS95660	length 140.0 outside diameter 78.0 flange diameter flange depth 11461-11040	length 62.8 comp. height +4.7	top 1.2 2nd 1.2 oil 3.0	
COROLLA STARLET EL51 EP91 (96-99) DOHC 16V			pin = 18.0 x 59.0 circlip not required 13101-11101	N-SWT10-128/164 R-28705/ 28804 T-35954 13011-11122 13011-11140 13011-11160 13011-11170 13011-11180	
TOYOTA 5E-FE Bore Dia. 74.0 mm 4 cyl. 1,497 cc	KBS95670	length 140.0 outside diameter 78.0 flange diameter flange depth 11461-11040	length 58.8 comp. height -5.4	top 1.2 2nd 1.2 oil 3.0	
PASEO TERCEL EL44 EL53 EL54 (91-99) DOHC 16V			pin = 18.0 x 57.0 circlip not required 13101-11130 13101-11131	N-SWT10-128/164 R-28705/ 28804 T-35954 13011-11122 13011-11140 13011-11160 13011-11170 13011-11180	
TOYOTA 5E-FE Bore Dia. 74.0 mm 4 cyl. 1,497 cc	KBS95671	length 140.0 outside diameter 78.0 flange diameter flange depth 11461-11040	length 61.5 comp. height +3.5	top 1.2 2nd 1.2 oil 3.0	
RESEO RAUM SERA TERCEL EL44 EL53 EL54 (94-99) DOHC 16V			pin = 18.0 x 59.0 circlip not required 13101-11160 13101-11161	N-SWT10-128/164 R-28705/ 28804 T-35954 13011-11122 13011-11140 13011-11160 13011-11170 13011-11180	

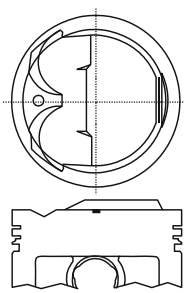
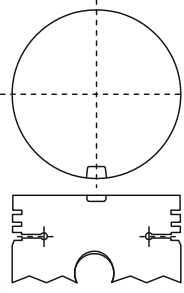
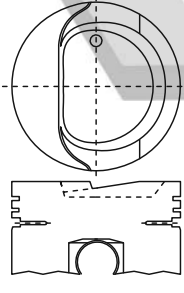

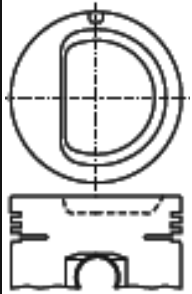
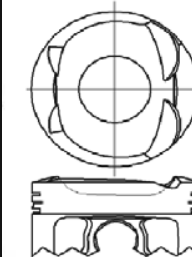
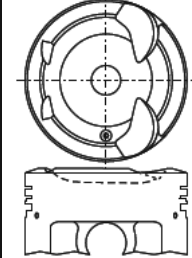
MOTOR - TYP	KOLBEN + RINGE PISTON + RINGS PISTONES + ANILLOS	LAUFBUCHSE CYL. SLEEVE CAMISAS	KOLBENSATZ PISTON SET PISTONES KIT	RINGSATZ RING SET ANILLOS	KOLBEN PISTON PISTONES
TOYOTA 4E-FE Bore Dia. 74.0 mm 4 cyl. 1,331 cc	KBS95680 head anodized	LB95680 length 140.0 outside diameter 78.0 flange diameter flange depth 11461-11040	KB95680 length 51.0 comp. height 30.0 +4.5	KR95680 top 1.2 2nd 1.2 oil 3.0	
			pin = 18.0 x 53.0 circlip not required 13101-11170	N-SWT10-128/164 R-28705 / 28804 T-35954 13011-11122 13011-11140 13011-11160 13011-11170 13011-11180	
COROLLA STARLET TERCEL (89-) DOHC 16V					
TOYOTA 3K / 3K-H(J) 4K / 4K-C(J) Bore Dia. 75.0 mm 4 cyl. 1,166 cc 1,290 cc	KBS95690	LB95690 length 122.0 outside diameter 79.0 flange diameter flange depth 11461-24010	KB95690 length 75.0 comp. height 36.0 +0	KR95690 top 2.0 2nd 2.0 oil 4.0	
			pin = 18.0 x 61.0 circlip required 13101-24010 13101-24011 13102-24011 13103-24010 13104-24010 13105-24010	N-SWT10-052 R-28510 T-35815 13011-22011/12 13011-24010/11/12 13011-24020/23/30 13012-22012/24010 13013-22012 13013-24010/11/12 13014-22012 13014-24010/11/12 13015-22012 13015-24010/11/12	
COROLLA LITEACE STARLET TOYOTA1000 KM1# KM20 KP37 KP61 KP62 (71-85) OHV 8V					
TOYOTA 4K 4K-E 4K-U Bore Dia. 75.0 mm 4 cyl. 1,290 cc	KBS95700	LB95700 length 140.0 outside diameter 79.0 flange diameter flange depth 11461-13010	KB95700 length 68.9 comp. height 36.0 -7.1	KR95700 top 1.5 2nd 1.5 oil 4.0	
			pin = 18.0 x 61.0 circlip required 13101-13020 13101-13021 13103-13020 13103-13021 13104-13020 13104-13021 13105-13020 13105-13021	N-SWT10-109 R-28940 T-35863 13011-13010 13011-13060 13013-13010 13014-13010 13015-13010	
COROLLA LITEACE STARLET KE70 KM20 KP61 (79-84) OHV 8V					

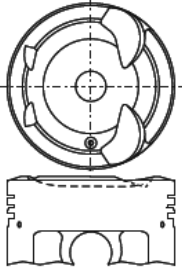
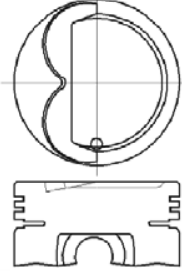
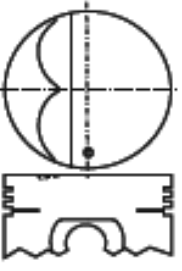
MOTOR - TYP	KOLBEN + RINGE PISTON + RINGS PISTONES + ANILLOS	LAUFBUCHSE CYL. SLEEVE CAMISAS	KOLBENSATZ PISTON SET PISTONES KIT	RINGSATZ RING SET ANILLOS	KOLBEN PISTON PISTONES
TOYOTA 4K Bore Dia. 75.0 mm 4 cyl. 1,290 cc COROLLA LITEACE STARLET KE70 KM20 KP61 (79-84) OHV 8V	KBS95710	LB95710 length 140.0 outside diameter 79.0 flange diameter flange depth 11461-13010	KB95710 length 68.9 comp. height 36.0 -7.5 pin = 18.0 x 61.0 circlip required	KR95710 top 2.0 2nd 2.0 oil 4.0 N- R-28851 T-35896 13011-13030 13013-13030 13014-13030 13015-13030	
			13101-13022 13103-13022 13104-13022 13105-13022		
TOYOTA 1NZ-FE 2NZ-FE Bore Dia. 75.0 mm 4 cyl. 1,298 cc COROLLA ECHO VERSO VIOS VITZ YARIS NCP11/12/20/22 NCP42/90/91/95 (02-) DOHC 16V	KBS27500	LB27500 length 140.0 outside diameter 79.0 flange diameter flange depth 11461-13010	KB27500 length 49.8 comp. height 30.7 -6.2 pin = 18.0 x 53.0 circlip not required	KR27500 top 1.2 2nd 1.2 oil 2.0 N-SWT10-192 R-28125 T-35973 / 35974 13011-21030 13011-21041 13011-21050 13011-21070	
			13101-21070 13101-21080		
TOYOTA 1NZ-FE Bore Dia. 75.0 mm 4 cyl. 1,496 cc DOHC	KBS27501	LB27501 length 140.0 outside diameter 79.0 flange diameter flange depth 11461-13010	KB27501 length 49.1 comp. height 30.0 -6.0 pin = 18.0 x 53.0 circlip not required	KR27500 top 1.2 2nd 1.2 oil 2.0 N-SWT10-192 R-28125 T-35973 / 35974 13011-21030 13011-21041 13011-21050 13011-21070	
			13101-21030		

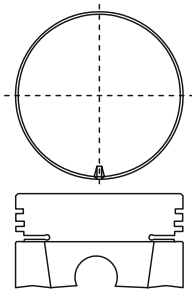
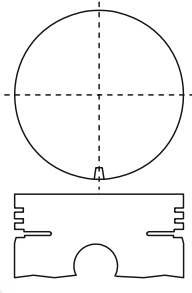
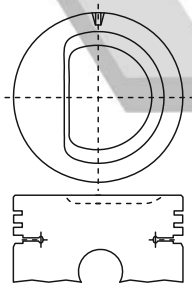

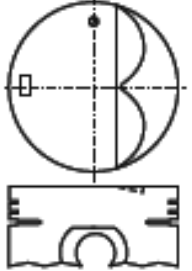
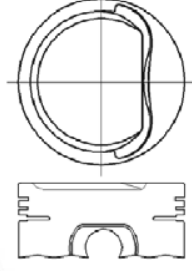
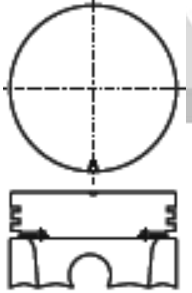
MOTOR - TYP	KOLBEN + RINGE PISTON + RINGS PISTONES + ANILLOS	LAUFBUCHSE CYL. SLEEVE CAMISAS	KOLBENSATZ PISTON SET PISTONES KIT	RINGSATZ RING SET ANILLOS	KOLBEN PISTON PISTONES
TOYOTA 2NZ-FE Bore Dia. 75.0 mm 4 cyl. 1,298 cc ECHO VITZ YARIS NCP10/11/15 (99-02) DOHC 16V	KBS95730	LB95730 length 140.0 outside diameter 79.0 flange diameter flange depth 11461-13010	KB95730 length 48.9 comp. height 30.0 -2.7 pin = 18.0 x 53.0 circlip not required 13101-21040	KR95730 top 1.2 2nd 1.2 oil 2.0 N-SWT10-192 R-28125 T-35973 / 35974 13011-21030 13011-21041 13011-21050 13011-21070	
TOYOTA 2A Bore Dia. 76.0 mm 4 cyl. 1,295 cc TERCEL AL20 (82-84) SOHC 8V	KBS95740	LB95740 length outside diameter flange diameter flange depth	KB95740 length 65.0 comp. height 34.0 -4.1 pin = 18.0 x 61.0 circlip not required 13101-14020 13103-14020 13104-14020 13105-14020	KR95740 top 2.0 2nd 2.0 oil 4.0 N-SXT10-068 SWT10-068 R-28070 T-35857 13011-14010 13011-14011 13011-14020 13011-14021 13013-14020 13014-14020 13015-14020	
TOYOTA 2A Bore Dia. 76.0 mm 4 cyl. 1,295 cc TERCEL AL11 (79-82) SOHC 8V	KBS95741	LB95741 length outside diameter flange diameter flange depth	KB95741 length 64.3 comp. height 33.3 +0 pin = 18.0 x 61.0 circlip not required 13101-14010 13103-14010 13104-14010 13105-14010	KR95741 top 2.0 2nd 2.0 oil 4.0 N-SXT10-068 SWT10-068 R-28070 T-35857 13011-14010 13011-14011 13011-14020 13011-14021 13013-14020 13014-14020 13015-14020	

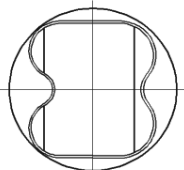
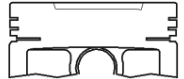
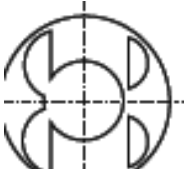
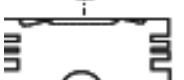
MOTOR - TYP	KOLBEN + RINGE PISTON + RINGS PISTONES + ANILLOS	LAUFBUCHSE CYL. SLEEVE CAMISAS	KOLBENSATZ PISTON SET PISTONES KIT	RINGSATZ RING SET ANILLOS	KOLBEN PISTON PISTONES
TOYOTA 3P Bore Dia. 76.6 mm 4 cyl. 1,345 cc FORKLIFT (72-79) OHV 8V	KBS95750	LB95750 length 137.0 outside diameter 81.0 flange diameter flange depth 11462-23010	length 76.0 comp. height 38.0 +0	top 2.0 2nd 2.0 oil 4.0	
			pin = 20.0 x 65.5 circlip required	N-SWT10-009 R-28500 T-35822	
			13101-23010 13101-23011	13011-23010 13011-23030	
TOYOTA 4P Bore Dia. 76.6 mm 4 cyl. 1,493 cc FORKLIFT OHV 8V	KBS95760	LB95760 length 163.0 outside diameter 81.0 flange diameter flange depth	length 71.0 comp. height 33.0 +0	top 2.0 2nd 2.0 oil 4.0	
			pin = 20.0 x 65.0 circlip required	N-SWT10-009 R-28500 T-35822	
			13101-78001 13101-96001	13011-23010 13011-23030	
TOYOTA 4P Bore Dia. 76.6 mm 4 cyl. 1,493 cc FORKLIFT OHV 8V	KBS95761	LB95761 length outside diameter flange diameter flange depth	length 72.4 comp. height 34.4 -3.5	top 2.0 2nd 2.0 oil 4.0	
			pin = 20.0 x 65.0 circlip required	N-SWT10-009 R-28500 T-35822	
				13011-23010 13011-23030	

MOTOR - TYP	KOLBEN + RINGE PISTON + RINGS PISTONES + ANILLOS	LAUFBUCHSE CYL. SLEEVE CAMISAS	KOLBENSATZ PISTON SET PISTONES KIT	RINGSATZ RING SET ANILLOS	KOLBEN PISTON PISTONES
TOYOTA 1A 1A-C 1A-U Bore Dia. 77.5 mm 4 cyl. 1,452 cc	KBS95770	LB95770	KB95770	KR95770	
COROLLA (78-79) SOHC 8V		outside diameter 81.5	comp. height -2.67	oil 2.8	
		flange depth	13101-15010	13011-15010/11 13011-15020/21 13011-15030/31 13013-15010/30 13013-15031 13014-15010/30 13015-15010/30	
		11461-15010			
TOYOTA 3A Bore Dia. 77.5 mm 4 cyl. 1,452 cc	KBS95780	LB95780	KB95780	KR95780	
TERCEL AL21 (82-88) SOHC 8V		outside diameter 81.5	comp. height -2.8	oil 2.8	
		flange depth	13101-15020 13103-15020 13104-15020 13105-15020	13011-15010/11 13011-15020/21 13011-15030/31 13013-15010/30 13013-15031 13014-15010/30 13015-15010/30	
		11461-15010			
TOYOTA 2R Bore Dia. 78.0 mm 4 cyl. 1,490 cc	KBS95790	LB95790	KB95790	KR95790	
HILUX STOUT TOYOACE (64-69) SOHC 8V		outside diameter 82.0	comp. height 39.7 +0	oil 4.0	
		flange depth	13101-31010 13101-31011	13011-31010 13011-31030 13011-31040	
		11462-31010			

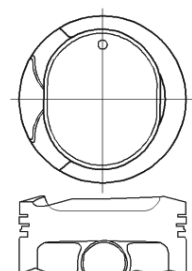
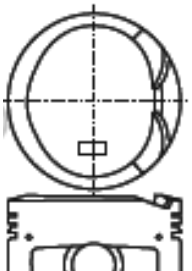
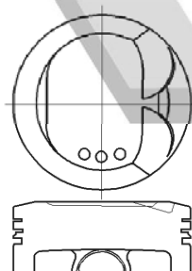
MOTOR - TYP	KOLBEN + RINGE PISTON + RINGS PISTONES + ANILLOS	LAUFBUCHSE CYL. SLEEVE CAMISAS	KOLBENSATZ PISTON SET PISTONES KIT	RINGSATZ RING SET ANILLOS	KOLBEN PISTON PISTONES
TOYOTA 5A-F Bore Dia. 78.7 mm 4 cyl. 1,498 cc	KBS95800	LB95800 length 140.0 outside diameter 82.7 flange diameter flange depth 11461-15040	KB95800 length 59.5 comp. height 30.5 -2.4 -3.0 pin = 18.0 x 61.0 circlip not required 13101-15040	KR95800 top 1.5 2nd 1.5 oil 3.0 N-SWT10-161 R-28244 T-35894 13011-15050	 
TOYOTA 5A-F Bore Dia. 78.7 mm 4 cyl. 1,498 cc	KBS95810	LB95810 length 140.0 outside diameter 82.7 flange diameter flange depth 11461-15040	KB95810 length 55.5 comp. height 30.5 -2.5 pin = 18.0 x 56.0 circlip not required 13101-15050	KR95810 top 1.2 2nd 1.5 oil 3.0 N-SWT10-181 R-28019 T-35920 13011-15100 13011-15120	 
TOYOTA 8A-FE Bore Dia. 78.7 mm 4 cyl. 1,342 cc	KBS95820	LB95820 length outside diameter flange diameter flange depth	KB95820 length 63.6 comp. height 35.65 +1.1 pin = 20.0 x 56.2 circlip not required 13101-14050	KR95820 top 1.2 2nd 1.5 oil 3.0 N- R-28853 T-35939 13011-15130	 

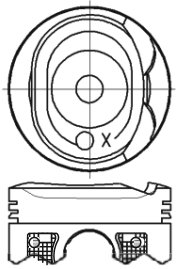
MOTOR - TYP	KOLBEN + RINGE PISTON + RINGS PISTONES + ANILLOS	LAUFBUCHSE CYL. SLEEVE CAMISAS	KOLBENSATZ PISTON SET PISTONES KIT	RINGSATZ RING SET ANILLOS	KOLBEN PISTON PISTONES
TOYOTA 1ZZ-FE Bore Dia. 79.0 mm 4 cyl. 1,794 cc	KBS11000 head, top and 2nd ring lands anodized	LB11000 length 220.0 outside diameter 83.0 flange diameter flange depth	KB11000 length 51.6 comp. height 32.1 -6.5	KR11000 top 1.2 2nd 1.2 oil 3.0	
			pin = 20.0 x 50.0 circlip required 13101-22020 13101-22030 13101-22031 13101-22140	N-SWT10-183 R-28785 T-35950 13011-OD010 13011-22030 13011-22040 13011-22090 13011-22100 13011-22111 13011-22200	
TOYOTA 3ZZ-FE Bore Dia. 79.0 mm 4 cyl. 1,598 cc	KBS57000 head, top and 2nd ring lands anodized	LB57000 length 193.5 outside diameter 83.0 flange diameter flange depth	KB57000 length 52.2 comp. height 32.2 -3.9	KR57000 top 1.2 2nd 1.2 oil 3.0	
			pin = 20.0 x 50.0 circlip required 13101-OD070	N-SWT10-183 R-28785 T-35950 13011-OD010 13011-22030 13011-22040 13011-22090 13011-22100 13011-22111 13011-22200	
TOYOTA 4ZZ-FE Bore Dia. 79.0 mm 4 cyl. 1,398 cc	KBS68000 head, top and 2nd ring lands anodized	LB68000 length outside diameter flange diameter flange depth	KB68000 length 51.7 comp. height 32.2 -1.48	KR11000 top 1.2 2nd 1.2 oil 3.0	
			pin = 20.0 x 50.0 circlip required 13101-22051 13101-22071	N-SWT10-183 R-28785 T-35950 13011-OD010 13011-22030 13011-22040 13011-22090 13011-22100 13011-22111 13011-22200	

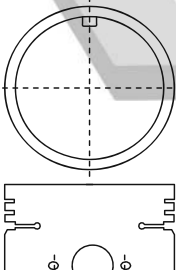
MOTOR - TYP	KOLBEN + RINGE PISTON + RINGS PISTONES + ANILLOS	LAUFBUCHSE CYL. SLEEVE CAMISAS	KOLBENSATZ PISTON SET PISTONES KIT	RINGSATZ RING SET ANILLOS	KOLBEN PISTON PISTONES
TOYOTA 1ZZ-FE Bore Dia. 79.0 mm 4 cyl. 1,794 cc	KBS11001 head, top and 2nd ring lands anodized skirt MOS2 treated	LB11001 length outside diameter flange diameter flange depth	KB11001 length 51.7 comp. height 32.2 -5.3 -6.6	KR11001 top 1.2 2nd 1.2 oil 3.0	
			pin = 20.0 x 50.0 circlip required 13101-22060	N-SWT10-183 R-28785 T-35950 13011-OD010 13011-22030 13011-22040 13011-22090 13011-22100 13011-22111 13011-22200	
COROLLA ZZE110 (97-) DOHC 16V					
TOYOTA 1ZZ-FE Bore Dia. 79.0 mm 4 cyl. 1,794 cc	KBS11002	LB11002 length 193.5 outside diameter 83.0 flange diameter flange depth	KB11002 length comp. height	KR11002 top 1.2 2nd 1.2 oil 2.0	
			pin = x	N- R- T- 13011-22240	
					2012 NEW
TOYOTA 12R Bore Dia. 80.5 mm 4 cyl. 1,587 cc	KBS95840	LB95840 length 144.0 outside diameter 84.5 flange diameter flange depth 11461-31020 11462-31020	KB95840 length 80.0 comp. height 39.0 +0	KR95840 top 2.0 2nd 2.0 oil 4.0	
			pin = 20.0 x 66.0 circlip required 13101-31020 13101-31021/22 13102-31020 13103-31020 13103-31021/22 13104-31020 13104-31021/22 13105-31020 13105-31021/22 13106-31020 13107-31020	N-SWT10-042 SX T10-042 R-28810 / 28818 28835 T-35830 / 35907 13011-31050/51 13011-31060/61 13011-31070/81 13011-31090/91 13011-81088 13012-31060/70 13013-31060/61/70 13014-31060/61/70 13015-31060/61/70 13016-31060/70 13017-31060/70	
HIACE HILUX TOYOACE RH11/20/30 RN20/25/30/40 RY10/12/20/30 (71-85) OHV 8V					

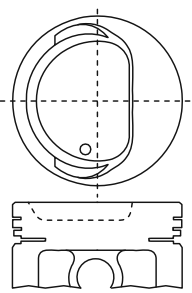
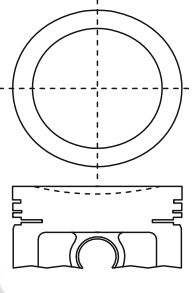
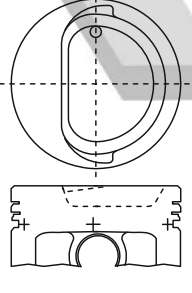
MOTOR - TYP	KOLBEN + RINGE PISTON + RINGS PISTONES + ANILLOS	LAUFBUCHSE CYL. SLEEVE CAMISAS	KOLBENSATZ PISTON SET PISTONES KIT	RINGSATZ RING SET ANILLOS	KOLBEN PISTON PISTONES
TOYOTA 5K Bore Dia. 80.5 mm 4 cyl. 1,486 cc 1,496 cc COROLLA LATEACE VAN WAGON KM3# KR2# (83-96) SOHC 8V	KBS95850	LB95850 length 146.0 outside diameter 84.5 flange diameter flange depth 11461-13040	KB95850 length 68.9 comp. height 36.0 -8.3 pin = 20.0 x 61.0 circlip required	KR95850 top 1.5 2nd 1.5 oil 4.0 N-SWT10-080/099 SWT10-160/169 R-28750/28867 28998 T-35861/35922	
			13101-13040 13103-13030	13011-13040/50 13011-13080/90 13011-13100/10 13011-13120 13011-63010/11 13011-63020/30 13011-63031 13013-13090 13013-63030 13014-63030 13015-63030	
TOYOTA 5K Bore Dia. 80.5 mm 4 cyl. 1,486 cc 1,496 cc COROLLA HIACE LITEACE VAN WAGON KIJANG KM30 KM36 (83-96) SOHC 8V	KBS95851	LB95851 length 146.0 outside diameter 84.5 flange diameter flange depth 11461-13040	KB95851 length 69.0 comp. height 36.0 -3.0 pin = 18.0 x 61.0 circlip required	KR95851 top 1.5 2nd 1.5 oil 4.0 N-SWT10-080/099 SWT10-160/169 R-28750/28867 28998 T-35861/35922	
			13101-13030 13103-13040	13011-13040/50 13011-13080/90 13011-13100/10 13011-13120 13011-63010/11 13011-63020/30 13011-63031 13013-13090 13013-63030 13014-63030 13015-63030	
TOYOTA 7K Bore Dia. 80.5 mm 4 cyl. 1,812 cc LITEACE KIJANG REVO (83-) SOHC 8V	KBS95860	LB95860 length 165.0 outside diameter 84.5 flange diameter flange depth 11461-13060	KB95860 length 58.7 comp. height 33.7 -9.7 pin = 20.0 x 56.0 circlip not required	KR95860 top 1.5 2nd 1.5 oil 4.0 N-SWT10-080/099 SWT10-160/169 R-28750/28867 28998 T-35861/35922	
			13101-06030	13011-13040/50 13011-13080/90 13011-13100/10 13011-13120 13011-63010/11 13011-63020/30 13011-63031 13013-13090 13013-63030 13014-63030 13015-63030	

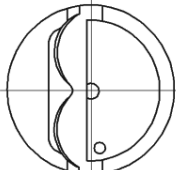
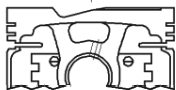
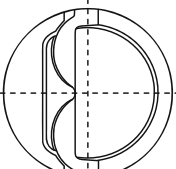
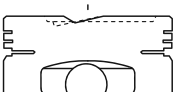
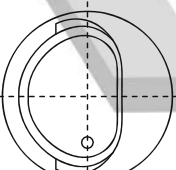
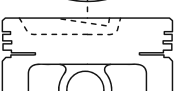
ENGINE MODEL	PISTON+RINGS	LAUFBUCHSE CYL. SLEEVE CAMISAS	KOLBENSATZ PISTON SET PISTONES KIT	RINGSATZ RING SET ANILLOS	KOLBEN PISTON PISTONES
TOYOTA 1S 1S-L 1S-U Bore Dia. 80.5 mm 4 cyl. 1,832 cc	KBS95870	LB95870	KB95870	KR95870	 
CAMRY SV10 SV20 (82-88) SOHC 8V		length 170.0 outside diameter 84.5 flange diameter flange depth	length 67.8 comp. height 33.0 -1.6 pin = 20.0 x 66.0 circlip not required 13101-63010 13101-63011 13103-63010 13103-63011 13104-63010 13104-63011 13105-63010 13105-63011	top 1.5 2nd 1.5 oil 4.0 N-SWT10-080/099 SWT10-160/169 R-28750/28867 28998 T-35861/35922 13011-13040/50 13011-13080/90 13011-13100/10 13011-13120 13011-63010/11 13011-63020/30 13011-63031 13013-13090 13013-63030 13014-63030 13015-63030	
TOYOTA 1S 1S-L 1S-U Bore Dia. 80.5 mm 4 cyl. 1,832 cc	KBS95871	LB95871	KB95871	KR95871	 
CAMRY CARINA CELICA CORONA VISTA SA60 SA60G ST140 ST150 SV10 (81-88) SOHC 8V		length 170.0 outside diameter 84.5 flange diameter flange depth	length 68.0 comp. height 33.0 -2.5 -4.5 pin = 20.0 x 66.0 circlip not required 13101-63020	top 1.5 2nd 1.5 oil 4.0 N-SWT10-080/099 SWT10-160/169 R-28750/28867 28998 T-35861/35922 13011-13040/50 13011-13080/90 13011-13100/10 13011-13120 13011-63010/11 13011-63020/30 13011-63031 13013-13090 13013-63030 13014-63030 13015-63030	
TOYOTA 5K Bore Dia. 80.5 mm 4 cyl. 1,486 cc 1,496 cc	KBS95880	LB95880	KB95880	KR95880	 
COROLLA HIACE LITEACE KIJANG (83-96) SOHC 8V		length 146.0 outside diameter 84.5 flange diameter flange depth 11461-13040	length 67.7 comp. height 34.7 -7.5 pin = 18.0 x 61.0 circlip required	top 1.5 2nd 1.5 oil 4.0 N-SWT10-080/099 SWT10-160/169 R-28750/28867 28998 T-35861/35922 13011-13040/50 13011-13080/90 13011-13100/10 13011-13120 13011-63010/11 13011-63020/30 13011-63031 13013-13090 13013-63030 13014-63030 13015-63030	

MOTOR - TYP	KOLBEN + RINGE PISTON + RINGS PISTONES + ANILLOS	LAUFBUCHSE CYL. SLEEVE CAMISAS	KOLBENSATZ PISTON SET PISTONES KIT	RINGSATZ RING SET ANILLOS	KOLBEN PISTON PISTONES
TOYOTA 3ZR-FE Bore Dia. 80.5 mm 4 cyl. 1,986 cc AVENSIS NOAH VOXY DOHC 16V	KBS30500 head, top and 2nd ring lands anodized skirt MOS2 treated	LB30500 length 165.0 outside diameter 84.5 flange diameter flange depth 11461-13060	KB30500 length comp. height pin = 20.0 x 50.0 circlip required	KR30500 top 1.2 2nd 1.0 oil 2.0 N- R- T- 13011-37150	
			13101-37130		
2012 NEW					
TOYOTA 3ZR-FAE 3ZR-FBE Bore Dia. 80.5 mm 4 cyl. 1,986 cc	KBS95890	LB95890 length 165.0 outside diameter 84.5 flange diameter flange depth	KB95890 length comp. height pin = x	KR95890 top 1.2 2nd 1.0 oil 2.0 N- R- T- 13011-37150	
			13101-37150		
2012 NEW					
TOYOTA 2ZR-FE Bore Dia. 80.5 mm 4 cyl. 1,797 cc COROLLA YARIS (06-) DOHC 16V	KBS29500 head, top and 2nd ring lands anodized skirt MOS2 treated	LB29500 length outside diameter flange diameter flange depth	KB29500 length 50.1 comp. height 31.0 -6.3 pin = 20.0 x 50.0 circlip required	KR29500 top 1.0 2nd 1.0 oil 1.5 N- R- T- 13011-37090	
			13101-37071		
2012 NEW					

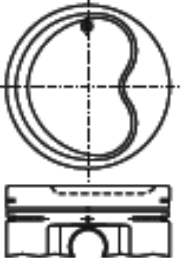
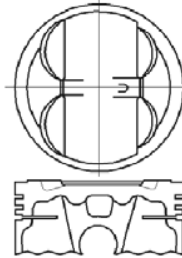
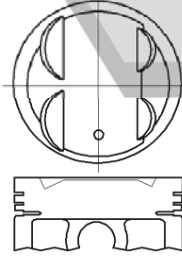
MOTOR - TYP	KOLBEN + RINGE PISTON + RINGS PISTONES + ANILLOS	LAUFBUCHSE CYL. SLEEVE CAMISAS	KOLBENSATZ PISTON SET PISTONES KIT	RINGSATZ RING SET ANILLOS	KOLBEN PISTON PISTONES
TOYOTA 4A-C 4A-LC Bore Dia. 81.0 mm 4 cyl. 1,587 cc	KBS95900	LB95900 length 150.0 outside diameter 85.0 flange diameter flange depth 11461-16010	KB95900 length 60.6 comp. height 30.6 -3.3 pin = 18.0 x 61.0 circlip not required 13101-16010 13103-16010	KR95900 top 1.5 2nd 1.5 oil 2.8 N-SWT10-101/108 SWT10-145 R-28210 / 28560 28600 / 28902 T-35876 / 35951	
CARINA II COROLLA AE71 AE82 AE86 (83-87) SOHC 8V					
TOYOTA 4A-GE 4A-GEL Bore Dia. 81.0 mm 4 cyl. 1,587 cc	KBS95910	LB95910 length 150.0 outside diameter 85.0 flange diameter flange depth 11461-16010	KB95910 length 64.7 comp. height 30.5 +0.2 pin = 18.0 x 61.0 circlip not required 13101-16030 13103-16030	KR95910 top 1.5 2nd 1.5 oil 2.8 N-SWT10-101/108 SWT10-145 R-28210 / 28560 28600 / 28902 T-35876 / 35951	
CARINA CELICA COROLLA MR2 AA63 AE86 AT160 AW11 (83-87) DOHC 16V					
TOYOTA 4A / 4A-GE 4A-GEC 4A-GELC Bore Dia. 81.0 mm 4 cyl. 1,587 cc	KBS95920	LB95920 length 150.0 outside diameter 85.0 flange diameter flange depth 11461-16010	KB95920 length 64.5 comp. height 30.5 -0.9 pin = 18.0 x 61.0 circlip not required 13101-16020 13103-16020	KR95920 top 1.5 2nd 1.5 oil 2.8 N-SWT10-101/108 SWT10-145 R-28210 / 28560 28600 / 28902 T-35876 / 35951	
COROLLA CELICA MR2 SPRINTER AA63 AE86 AW11 (83-87) DOHC 16V					

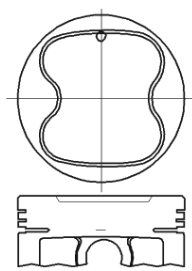
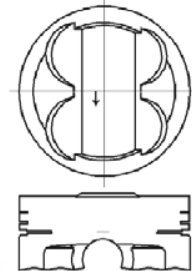
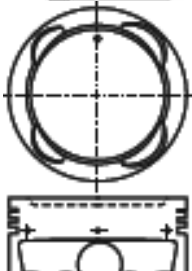
MOTOR - TYP	KOLBEN + RINGE PISTON + RINGS PISTONES + ANILLOS	LAUFBUCHSE CYL. SLEEVE CAMISAS	KOLBENSATZ PISTON SET PISTONES KIT	RINGSATZ RING SET ANILLOS	KOLBEN PISTON PISTONES
TOYOTA 4A-F 4A-FE Bore Dia. 81.0 mm 4 cyl. 1,587 cc CARINA 2 CELICA COROLLA MR2 AE95/101/171 AT180/190/192 (87-97) DOHC 16V	KBS13000	LB13000 length 150.0 outside diameter 85.0 flange diameter flange depth 11461-16010	KB13000 length 61.0 comp. height 30.5 -2.8 pin = 18.0 x 61.0 circlip not required 13101-16090 13101-16110 13101-16200 13103-16090 13103-16110 13103-16200	KR13000 top 1.5 2nd 1.5 oil 3.0 N-SWT10-142 R-28260/28265 T-35908 13011-16070 13011-16120 13011-16130 13011-16140 13011-16150 13013-16120 13013-16140	
			13011-16090 13011-16110 13011-16200 13011-16120 13011-16130 13011-16140 13011-16150 13013-16120 13013-16140		
TOYOTA 4A-GEU Bore Dia. 81.0 mm 4 cyl. 1,587 cc CARINA CELICA COROLLA MR2 (83-87) DOHC 16V	KBS95940	LB95940 length 150.0 outside diameter 85.0 flange diameter flange depth 11461-16010	KB95940 length 66.0 comp. height 30.5 +1.5 pin = 20.0 x 61.0 circlip required 13101-16121 13101-16212	KR95940 top 1.2 2nd 1.5 oil 2.8 N-SWT10-150 R-28212 / 28221 T-35910 13011-16190 13011-16200 13011-16210	
			13011-16121 13011-16212		
TOYOTA 7A-FE Bore Dia. 81.0 mm 4 cyl. 1,762 cc AVENSIS CARINA CELICA COROLLA SPRINTER AT191 AT200 (92-) DOHC 16V	KBS95950	LB95950 length 150.0 outside diameter 85.0 flange diameter flange depth 11461-16010	KB95950 length 55.6 comp. height 30.5 -3.3 pin = 20.0 x 56.0 circlip not required 13101-16150	KR95950 top 1.2 2nd 1.5 oil 3.0 N-SWT10-156 R-28093 / 28256 28331 / 28672 T-35913 / 35976 35989 13011-16230 13011-16280 13011-16290 13011-16300 13011-16320 13011-16330 13011-16340 13011-16350	
			13011-16150		

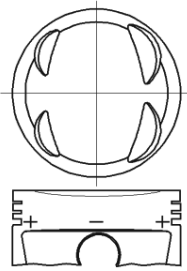
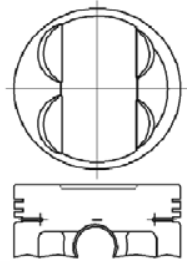
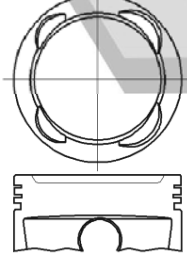
MOTOR - TYP	KOLBEN + RINGE PISTON + RINGS PISTONES + ANILLOS	LAUFBUCHSE CYL. SLEEVE CAMISAS	KOLBENSATZ PISTON SET PISTONES KIT	RINGSATZ RING SET ANILLOS	KOLBEN PISTON PISTONES
TOYOTA 4A-F 4A-FE Bore Dia. 81.0 mm 4 cyl. 1,762 cc CARINA CELICA COROLLA MR2 AE95/101 AT171/180/190 (87-97) DOHC 16V	KBS13001	LB13001 length 150.0 outside diameter 85.0 flange diameter flange depth 11461-16010	KB13001 length 55.7 comp. height 30.5 -2.5 pin = 20.0 x 56.0 circlip not required 13101-16160 13101-16171 13103-16171	KR13001 top 1.2 2nd 1.5 oil 3.0 N-SWT10-156 R-28093 / 28256 28331 / 28672 T-35913 / 35976 35989	
			13011-16230 13011-16280 13011-16290 13011-16300 13011-16320 13011-16330 13011-16340 13011-16350		
TOYOTA 4A 4A-GEL 4A-GELC Bore Dia. 81.0 mm 4 cyl. 1,587 cc CELICA COROLLA MR2 SPRINTER AE82 AE92 AW11 AT160 AT171 (87-92) DOHC 16V	KBS95970	LB95970 length 150.0 outside diameter 85.0 flange diameter flange depth 11461-16010	KB95970 length 64.6 comp. height 30.6 -1.0 pin = 20.0 x 61.0 circlip required 13101-16070 13103-16070	KR95970 top 1.5 2nd 1.5 oil 2.8 N-SWT10-101/108 SWT10-145 R-28210 / 28560 28600 / 28902 T-35876 / 35951	
			13011-16010/11 13011-16030/31 13011-16032/50 13011-16070/80 13011-16090 13011-16180 13011-16290 13013-16032/50 13013-16070 13013-16180		
TOYOTA 7A-FE Bore Dia. 81.0 mm 4 cyl. 1,762 cc AVENSIS CARINA CELICA COROLLA AT191 AT200 (93-99) DOHC 16V	KBS95980	LB95980 length 150.0 outside diameter 85.0 flange diameter flange depth 11461-16010	KB95980 length 55.6 comp. height 30.5 -3.61 pin = 20.0 x 56.0 circlip not required 13101-16190 13103-16190	KR95980 top 1.2 2nd 1.5 oil 3.0 N-SWT10-156 R-28093 / 28256 28331 / 28672 T-35913 / 35976 35989	
			13011-16230 13011-16280 13011-16290 13011-16300 13011-16320 13011-16330 13011-16340 13011-16350		

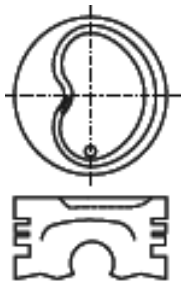
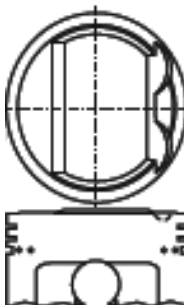
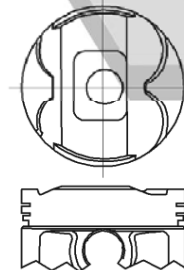
MOTOR - TYP	KOLBEN + RINGE PISTON + RINGS PISTONES + ANILLOS	LAUFBUCHSE CYL. SLEEVE CAMISAS	KOLBENSATZ PISTON SET PISTONES KIT	RINGSATZ RING SET ANILLOS	KOLBEN PISTON PISTONES
TOYOTA 4A-L Bore Dia. 81.0 mm 4 cyl. 1,587 cc	KBS95990	LB95990 length 150.0 outside diameter 85.0 flange diameter flange depth 11461-16010	length 60.5 comp. height 30.5 -2.8	top 1.5 2nd 1.5 oil 3.0	
			pin = 18.0 x 61.0 circlip not required 13101-16050 13103-16150	N-SWT10-142 R-28260/28265 T-35908 13011-16070 13011-16120 13011-16130 13011-16140 13011-16150 13013-16120 13013-16140	
CELICA AT160 (85-89) SOHC 8V	TOYOTA 4A-GE Bore Dia. 81.0 mm 4 cyl. 1,587 cc	LB96000 length 150.0 outside diameter 85.0 flange diameter flange depth 11461-16010	length 50.2 comp. height 30.4 +1.8	top 1.2 2nd 1.5 oil 3.0	
COROLLA AE111 (95-01) DOHC 20V			pin = 20.0 x 56.3 circlip required 13101-16220 13101-16221 13103-16220	N-SWT10-156 R-28093 / 28256 28331 / 28672 T-35913 / 35976 35989 13011-16230 13011-16280 13011-16290 13011-16300 13011-16320 13011-16330 13011-16340 13011-16350	
TOYOTA 2ZZ-GE Bore Dia. 82.0 mm 4 cyl. 1,796 cc	KBS77000	LB77000 length outside diameter flange diameter flange depth	length 56.2 comp. height 31.2 +1.5	top 1.2 2nd 1.2 oil 3.0	
			pin = 20.0 x 56.5 circlip required 13101-88600 13101-88601	N-SWT10-196 R- T- 13011-88600 13011-88601	
CELICA ZZT230 ZZT231 (99-05) DOHC 16V					

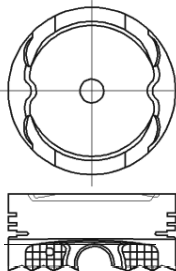
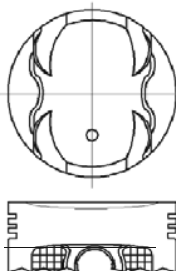
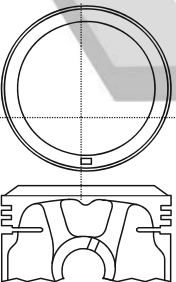
MOTOR - TYP	KOLBEN + RINGE PISTON + RINGS PISTONES + ANILLOS	LAUFBUCHSE CYL. SLEEVE CAMISAS	KOLBENSATZ PISTON SET PISTONES KIT	RINGSATZ RING SET ANILLOS	KOLBEN PISTON PISTONES
TOYOTA 4S-FE 4S-FI Bore Dia. 82.5 mm 4 cyl. 1,838 cc CRESTA SX80 (88-92) SOHC 8V	KBS96010	LB96010 length outside diameter flange diameter flange depth	KB96010	KR96010	
			length 70.3 comp. height 35.4 -3.2	top 1.5 2nd 1.5 oil 4.0	
			pin = 20.0 x 66.0 circlip not required	N-SWT10-123 R-23023 T-35917	
			13101-74071 13103-74071 13104-74071	13011-74110 13011-74120 13011-74121 13013-74110 13013-74120 13014-74110 13014-74120	
TOYOTA 4S Bore Dia. 82.5 mm 4 cyl. 1,838 cc CRESTA SX80 (88-92) SOHC 8V	KBS96020	LB96020 length outside diameter flange diameter flange depth	KB96020	KR96020	
			length 67.8 comp. height 35.0 -2.7	top 1.5 2nd 1.5 oil 4.0	
			pin = 22.0 x 66.0 circlip required	N-SWT10-123 R-28023 T-35917	
			13101-74160 13103-74160 13104-74160	13011-74110 13011-74120 13011-74121 13013-74110 13013-74120 13014-74110 13014-74120	
TOYOTA 21R Bore Dia. 84.0 mm 4 cyl. 1,972 cc SOHC 8V	KBS96030	LB96030 length 150.0 outside diameter 88.0 flange diameter flange depth	KB96030	KR96030	
			length 84.0 comp. height 39.0 +5.0	top 2.0 2nd 2.0 oil 4.0	
			pin = 22.0 x 72.0 circlip required	N-SXT10-067 R-28660 T-	
			13101-37010	13011-37010	

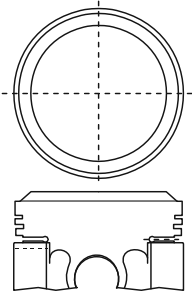
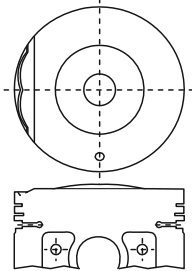
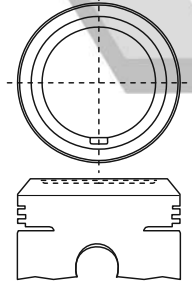
MOTOR - TYP	KOLBEN + RINGE PISTON + RINGS PISTONES + ANILLOS	LAUFBUCHSE CYL. SLEEVE CAMISAS	KOLBENSATZ PISTON SET PISTONES KIT	RINGSATZ RING SET ANILLOS	KOLBEN PISTON PISTONES
TOYOTA 21R Bore Dia. 84.0 mm 4 cyl. 1,972 cc CELICA RA60 RA61 (81-84) SOHC 8V	KBS96031	LB96031 length 150.0 outside diameter 88.0 flange diameter flange depth	KB96031 length 84.0 comp. height 39.0 +5.0 pin = 22.0 x 72.5 circlip required	KR96031 top 1.5 2nd 2.0 oil 4.0 N-SWT10-076 R-28920 T-35853	
			13101-37030 13101-37050 13103-37040 13103-37060 13105-37040 13105-37060	13011-37030 13011-37050 13011-37060 13013-37050 13013-37060 13015-37050 13015-37060	
TOYOTA 21R Bore Dia. 84.0 mm 4 cyl. 1,972 cc CELICA RA61 (84-85) SOHC 8V	KBS96032	LB96032 length 150.0 outside diameter 88.0 flange diameter flange depth	KB96032 length 65.4 comp. height 34.9 +2.5 pin = 22.0 x 66.0 circlip required	KR96032 top 1.5 2nd 1.5 oil 4.0 N-SWT0-102 R-28661 / 28662 T-35880	
			13101-37060 13101-37061 13103-37070 13105-37070	13011-37070 13011-37071 13013-37070 13015-37070	
TOYOTA 21R 21R-C Bore Dia. 84.0 mm 4 cyl. 1,972 cc SOHC 8V	KBS96040	LB96040 length 150.0 outside diameter 88.0 flange diameter flange depth	KB96040 length 85.8 comp. height 39.0 +7.1 pin = 22.0 x 72.5 circlip required	KR96040 top 1.5 2nd 2.0 oil 4.0 N-SWT10-076 R-28920 T-35853	
			13011-37030 13011-37050 13011-37060 13013-37050 13013-37060 13015-37050 13015-37060		

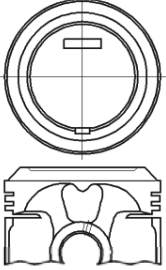
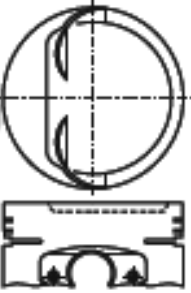
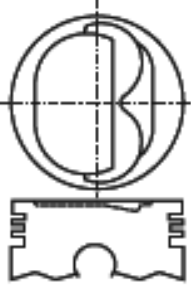
MOTOR - TYP	KOLBEN + RINGE PISTON + RINGS PISTONES + ANILLOS	LAUFBUCHSE CYL. SLEEVE CAMISAS	KOLBENSATZ PISTON SET PISTONES KIT	RINGSATZ RING SET ANILLOS	KOLBEN PISTON PISTONES
TOYOTA 21R-C Bore Dia. 84.0 mm 4 cyl. 1,972 cc	KBS96050	LB96050 length outside diameter flange diameter flange depth	KB96050 length 85.4 comp. height 38.9 +6.8	KR96050 top 1.5 2nd 2.0 oil 4.0	
			pin = 22.0 x 72.0 circlip required 13101-37020 13103-37030 13105-37030	N-SWT10-076 R-28920 T-35853 13011-37030 13011-37050 13011-37060 13013-37050 13013-37060 13015-37050 13015-37060	
CELICA RA60 (81-83) SOHC 8V	TOYOTA 2S-C 2S-ELC Bore Dia. 84.0 mm 4 cyl. 1,955 cc	LB96060 length outside diameter flange diameter flange depth	KB96060 length 70.3 comp. height 33.4 -4.2	KR96060 top 1.5 2nd 1.5 oil 4.0	
CAMRY CELICA SV11 (83-86) SOHC 8V			pin = 22.0 x 66.0 circlip not required 13101-74010 13101-74011 13103-74010 13103-74011 13104-74010 13104-74011 13105-74010 13105-74011	N-SWT10-088 R-28007/ 28031 T-35866 13011-74010 13011-74020 13011-74030 13011-74040/41 13013-74020 13013-74030/40 13014-74020 13014-74030/40 13015-74020 13015-74030/40	
TOYOTA 2S-EL Bore Dia. 84.0 mm 4 cyl. 1,955 cc	KBS96070	LB96070 length outside diameter flange diameter flange depth	KB96070 length 70.2 comp. height 33.4 -3.3	KR96070 top 1.5 2nd 1.5 oil 4.0	
			CAMRY SV11 (83-86) SOHC 8V	pin = 20.0 x 66.0 circlip not required 13101-74020 13101-74021 13103-74020 13103-74021 13104-74020 13104-74021 13105-74020 13105-74021	

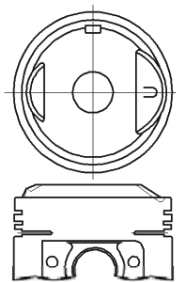
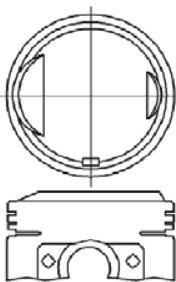
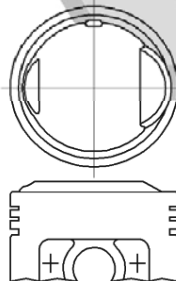
MOTOR - TYP	KOLBEN + RINGE PISTON + RINGS PISTONES + ANILLOS	LAUFBUCHSE CYL. SLEEVE CAMISAS	KOLBENSATZ PISTON SET PISTONES KIT	RINGSATZ RING SET ANILLOS	KOLBEN PISTON PISTONES
TOYOTA 2T Bore Dia. 85.0 mm 4 cyl. 1,588 cc CARINA CELICA TA1# TA40 (75-77) SOHC 8V	KBS96080	LB96080 length 150.0 outside diameter 89.0 flange diameter flange depth 11461-25010 11461-28010	KB96080 length 91.7 comp. height 39.0 +7.0 pin = 22.0 x 66.0 circlip not required	KR96080 top 2.0 2nd 2.0 oil 4.0 N-SWT10-040 S X T10-040 R-28030 T-35825	
			13101-26030 13103-26030 13104-26030 13105-26030	13011-26020/30 13011-26040/41 13011-27020 13012-26010/30 13012-26040/41 13013-26010/30 13013-26040/41 13013-27020 13014-26010/30 13014-26040/41 13014-27020 13015-26010/30 13015-26040/41 13015-27020	
TOYOTA 3T Bore Dia. 85.0 mm 4 cyl. 1,770 cc CARINA TA47 TA62 (79-83) SOHC 8V	KBS96090	LB96090 length 150.0 outside diameter 89.0 flange diameter flange depth 11461-25010 11461-28010	KB96090 length 82.5 comp. height 35.2 +5.3 pin = 22.0 x 66.0 circlip not required	KR96090 top 1.5 2nd 1.5 oil 4.0 N-SWT10-059 S X T10-059 R-28900 T-35845/ 35958	
			13101-28010 13103-28010 13104-28010 13105-28010	13011-28010/11 13011-28012/20 13011-28030/31 13011-28070/71 13013-28011 13013-28030/31 13014-28011 13014-28030/31 13015-28011 13015-28030/31	
TOYOTA 2T 2T-B Bore Dia. 85.0 mm 4 cyl. 1,588 cc CARINA CELICA TA12 TA40 (70-77) SOHC 8V	KBS96100	LB96100 length 150.0 outside diameter 89.0 flange diameter flange depth 11461-25010 11461-28010	KB96100 length 90.6 comp. height 39.0 +5.8 pin = 20.0 x 66.0 circlip not required	KR96100 top 2.0 2nd 2.0 oil 4.0 N-SWT10-040 S X T10-040 R-28030 T-35825	
			13101-26010 13101-26011 13102-26010 13102-26011 13103-26010 13103-26011 13104-26010 13104-26011 13105-26010 13105-26011	13011-26020/30 13011-26040/41 13011-27020 13012-26010/30 13012-26040/41 13013-26010/30 13013-26040/41 13013-27020 13014-26010/30 13014-26040/41 13014-27020 13015-26010/30 13015-26040/41 13015-27020	

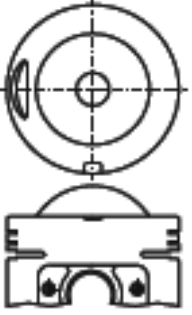
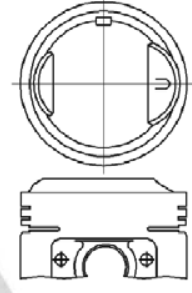
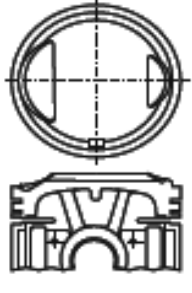
MOTOR - TYP	KOLBEN + RINGE PISTON + RINGS PISTONES + ANILLOS	LAUFBUCHSE CYL. SLEEVE CAMISAS	KOLBENSATZ PISTON SET PISTONES KIT	RINGSATZ RING SET ANILLOS	KOLBEN PISTON PISTONES
TOYOTA 2T 2T-C Bore Dia. 85.0 mm 4 cyl. 1,588 cc SOHC 8V	KBS96110	LB96110 length 150.0 outside diameter 89.0 flange diameter flange depth 11461-25010 11461-28010	KB96110 length 99.4 comp. height 39.2 +14.5 pin = 22.0 x 66.0 circlip not required 13101-26020 13101-26021	KR96110 top 2.0 2nd 2.0 oil 4.0 N-SWT10-040 S X T10-040 R-28030 T-35825 13011-26020/30 13011-26040/41 13011-27020 13012-26010/30 13012-26040/41 13013-26010/30 13013-26040/41 13013-27020 13014-26010/30 13014-26040/41 13014-27020 13015-26010/30 13015-26040/41 13015-27020	
TOYOTA 2T 2T-B 2T-C Bore Dia. 85.0 mm 4 cyl. 1,588 cc CARINA CELICA TA40 TA60 (77-85) SOHC 8V	KBS96120	LB96120 length 150.0 outside diameter 89.0 flange diameter flange depth 11461-25010 11461-28010	KB96120 length 91.7 comp. height 39.0 +7.0 pin = 22.0 x 66.0 circlip not required 13101-26031 13103-26031 13104-26031 13105-26031	KR96120 top 1.5 2nd 1.5 oil 4.0 N-SWT10-059 S X T10-059 R-28900 T-35845/ 35958 13011-28010/11 13011-28012/20 13011-28030/31 13011-28070/71 13013-28011 13013-28030/31 13014-28011 13014-28030/31 13015-28011 13015-28030/31	
TOYOTA 2T-B Bore Dia. 85.0 mm 4 cyl. 1,588 cc CARINA CELICA TA40 (77-79) SOHC 8V	KBS96130	LB96130 length 150.0 outside diameter 89.0 flange diameter flange depth 11461-25010 11461-28010	KB96130 length 90.8 comp. height 39.0 +5.8 pin = 20.0 x 66.0 circlip not required 13101-26040 13103-26040 13104-26040 13105-26040	KR96130 top 1.5 2nd 1.5 oil 4.0 N-SWT10-059 S X T10-059 R-28900 T-35845/ 35958 13011-28010/11 13011-28012/20 13011-28030/31 13011-28070/71 13013-28011 13013-28030/31 13014-28011 13014-28030/31 13015-28011 13015-28030/31	

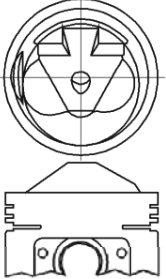
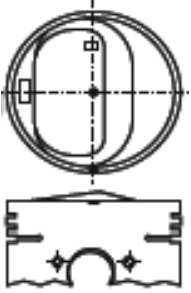
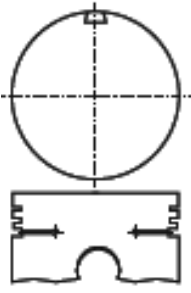
MOTOR - TYP	KOLBEN + RINGE PISTON + RINGS PISTONES + ANILLOS	LAUFBUCHSE CYL. SLEEVE CAMISAS	KOLBENSATZ PISTON SET PISTONES KIT	RINGSATZ RING SET ANILLOS	KOLBEN PISTON PISTONES
TOYOTA 13T Bore Dia. 85.0 mm 4 cyl. 1,588 cc COROLLA (77-80) SOHC 8V	KBS96140	LB96140 length 150.0 outside diameter 89.0 flange diameter flange depth 11461-25010 11461-28010	KB96140 length 97.3 comp. height 39.0 +0.2 +16.6	KR96140 top 1.5 2nd 1.5 oil 4.0	
			pin = 22.0 x 65.0 circlip not required 13101-27040	N-SWT10-059 SXT10-059 R-28900 T-35845/35958 13011-28010/11 13011-28012/20 13011-28030/31 13011-28070/71 13013-28011 13013-28030/31 13014-28011 13014-28030/31 13015-28011 13015-28030/31	
TOYOTA 8R Bore Dia. 86.0 mm 4 cyl. 1,858 cc CORONA HILUX (68-73) SOHC 8V	KBS96150	LB96150 length outside diameter flange diameter flange depth	KB96150 length 85.8 comp. height 39.3 +4.5	KR96150 top 2.0 2nd 2.5 oil 4.0	
			pin = 22.0 x 73.0 circlip required 13101-33021 13101-33022 13101-33023 13101-33024	N-SWT10-019 R-28580 T-35820 13011-31010 13011-33010 13011-33020 13011-33021 13011-33022 13011-33030	
TOYOTA 8R Bore Dia. 86.0 mm 4 cyl. 1,858 cc CORONA HILUX (68-73) SOHC 8V	KBS96160	LB96160 length outside diameter flange diameter flange depth	KB96160 length 84.8 comp. height 39.8 +0	KR96160 top 2.0 2nd 2.5 oil 4.0	
			pin = 22.0 x 73.0 circlip required 13101-33010 13101-33012 13101-33013 13101-33014	N-SWT10-019 R-28580 T-35820 13011-31010 13011-33010 13011-33020 13011-33021 13011-33022 13011-33030	

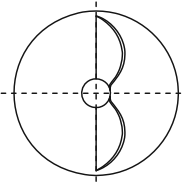
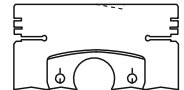
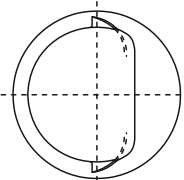
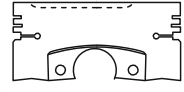
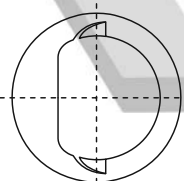
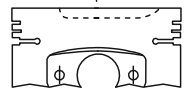
MOTOR - TYP	KOLBEN + RINGE PISTON + RINGS PISTONES + ANILLOS	LAUFBUCHSE CYL. SLEEVE CAMISAS	KOLBENSATZ PISTON SET PISTONES KIT	RINGSATZ RING SET ANILLOS	KOLBEN PISTON PISTONES
TOYOTA 1Y Bore Dia. 86.0 mm 4 cyl. 1,626 cc HILUX LITEACE DYNA 100 / 150 YH80 YM20 YN50 YN55 (83-98) OHV 8V	KBS96170	LB96170 length 144.0 outside diameter 90.0 flange diameter flange depth 11461-71010	KB96170 length 74.0 comp. height 39.0 -2.0 pin = 22.0 x 66.0 circlip not required 13101-71010 13103-71010 13104-71010 13105-71010	KR96170 top 1.5 2nd 1.5 oil 4.0 N-SWT10-090 R-28720/ 28805 T-35869/ 35930 13011-71010/20/21 13011-71030/31/33 13011-71040 13011-72020 13013-71020/21 13013-71030/31 13014-71020/21 13014-71030/31 13015-71020/21 13015-71030/31	 
			13011-71010/20/21 13011-71030/31/33 13011-71040 13011-72020 13013-71020/21 13013-71030/31 13014-71020/21 13014-71030/31 13015-71020/21 13015-71030/31		
TOYOTA 2Y 2Y-C Bore Dia. 86.0 mm 4 cyl. 1,812 cc DYNA DYNA 1000 HIACE HILUX LITEACE MODEL-F YH50/60/81 YM21 YN51/56/85/90 YR20 YY100 (82-01) OHV 8V	KBS96180	LB96180 length 154.0 outside diameter 90.0 flange diameter flange depth 11462-72010	KB96180 length 70.0 comp. height 35.0 -2.3 pin = 22.0 x 66.0 circlip not required 13101-72010 13103-72010 13104-72010 13105-72010	KR96180 top 1.5 2nd 1.5 oil 4.0 N-SWT10-090 R-28720/ 28805 T-35869/ 35930 13011-71010/20/21 13011-71030/31/33 13011-71040 13011-72020 13013-71020/21 13013-71030/31 13014-71020/21 13014-71030/31 13015-71020/21 13015-71030/31	 
			13011-71010/20/21 13011-71030/31/33 13011-71040 13011-72020 13013-71020/21 13013-71030/31 13014-71020/21 13014-71030/31 13015-71020/21 13015-71030/31		
TOYOTA 3Y 3Y-EC Bore Dia. 86.0 mm 4 cyl. 1,812 cc COMUTER DYNA 150 HIACE HILUX MODEL-F VAN YM51/61/71 YN52/57/60/65 YR2/21 YU6#/70/80 YY211 (82-01) OHV 8V	KBS96190	LB96190 length 144.0 outside diameter 90.0 flange diameter flange depth 11461-73010	KB96190 length 70.0 comp. height 35.0 -5.0 pin = 22.0 x 66.0 circlip not required 13101-73010 13103-73010 13104-73010 13105-73010	KR96190 top 1.5 2nd 1.5 oil 4.0 N-SWT10-090 R-28720/ 28805 T-35869/ 35930 13011-71010/20/21 13011-71030/31/33 13011-71040 13011-72020 13013-71020/21 13013-71030/31 13014-71020/21 13014-71030/31 13015-71020/21 13015-71030/31	 
			13011-71010/20/21 13011-71030/31/33 13011-71040 13011-72020 13013-71020/21 13013-71030/31 13014-71020/21 13014-71030/31 13015-71020/21 13015-71030/31		

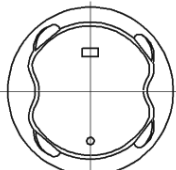
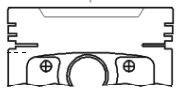
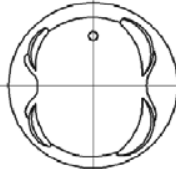
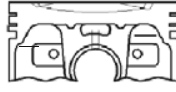
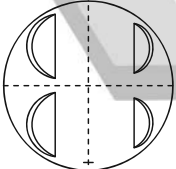
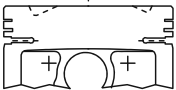
MOTOR - TYP	KOLBEN + RINGE PISTON + RINGS PISTONES + ANILLOS	LAUFBUCHSE CYL. SLEEVE CAMISAS	KOLBENSATZ PISTON SET PISTONES KIT	RINGSATZ RING SET ANILLOS	KOLBEN PISTON PISTONES
TOYOTA 3S-FE Bore Dia. 86.0 mm 4 cyl. 1,998 cc CAMRY SV2# SV25 (87-90) DOHC 16V	KBS96200	LB96200 length 177.8 outside diameter 90.0 flange diameter flange depth 11461-61030	KB96200 length 68.4 comp. height 35.4 -4.4 pin = 20.0 x 66.0 circlip not required 13101-74040 13103-74040	KR96200 top 1.5 2nd 1.5 oil 4.0 N-SWT10-119 R-28001 / 28027 T-35885 / 35902 35942 13011-74070/71 13011-74072/80 13011-74081/91 13011-74131 13011-74280 13013-74071/72 13013-74091 13013-74131 13013-74280	 
			13011-74070/71 13011-74072/80 13011-74081/91 13011-74131 13011-74280 13013-74071/72 13013-74091 13013-74131 13013-74280		
TOYOTA 3S-FE Bore Dia. 86.0 mm 4 cyl. 1,998 cc RAV 4 SXA1# (94-97) DOHC 16V	KBS96201	LB96201 length 177.8 outside diameter 90.0 flange diameter flange depth 11461-61030	KB96201 length 68.0 comp. height 35.0 -4.3 pin = 22.0 x 66.0 circlip required 13101-74100 13103-74100	KR96201 top 1.5 2nd 1.5 oil 4.0 N-SWT10-119 R-28001 / 28027 T-35885 / 35902 35942 13011-74070/71 13011-74072/80 13011-74081/91 13011-74131 13011-74280 13013-74071/72 13013-74091 13013-74131 13013-74280	 
			13011-74070/71 13011-74072/80 13011-74081/91 13011-74131 13011-74280 13013-74071/72 13013-74091 13013-74131 13013-74280		
TOYOTA 3S-GELU Bore Dia. 86.0 mm 4 cyl. 1,998 cc CAMRY VISTA SV12 (85-86) DOHC 16V	KBS96210	LB96210 length 177.8 outside diameter 90.0 flange diameter flange depth 11461-61030	KB96210 length 67.1 comp. height 35.1 +0 pin = 22.0 x 66.0 circlip required 13101-74030 13101-74031 13101-74032	KR96210 top 1.2 2nd 1.5 oil 4.0 N-SWT10-141 R-28891 T-35995 13011-74100 13011-88362 13011-88363 13011-88380 13013-88380	 
			13011-74100 13011-88362 13011-88363 13011-88380 13013-88380		

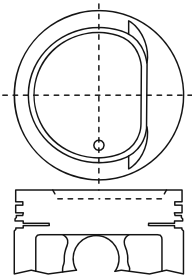
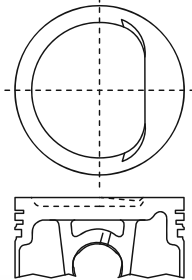
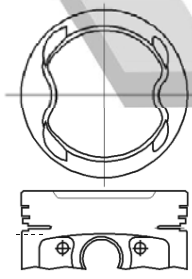
MOTOR - TYP	KOLBEN + RINGE PISTON + RINGS PISTONES + ANILLOS	LAUFBUCHSE CYL. SLEEVE CAMISAS	KOLBENSATZ PISTON SET PISTONES KIT	RINGSATZ RING SET ANILLOS	KOLBEN PISTON PISTONES
TOYOTA 1RZ Bore Dia. 86.0 mm 4 cyl. 1,998 cc COMUTER HIACE VAN RZH102 RZH104 RZH112 RZH114 (89-97) SOHC 8V	KBS96220	LB96220 length 170.0 outside diameter 89.5 flange diameter flange depth 11461-75010	KB96220 length 67.4 comp. height 35.5 -4.2 pin = 24.0 x 61.0 circlip required 13101-75010 13103-75010	KR96220 top 1.75 2nd 1.5 oil 4.0 N-SWT10-125 R-28002/ 28775 T-35904 13011-75010 13011-75020 13011-75080 13013-75020 13013-75080	
			length 170.0 outside diameter 89.5 flange diameter flange depth 11461-75010	length 59.0 comp. height 35.5 -4.4 pin = 24.0 x 61.0 circlip required 13011-75010 13011-75020 13011-75080 13013-75020 13013-75080	
TOYOTA 1RZ Bore Dia. 86.0 mm 4 cyl. 1,998 cc SOHC 8V	KBS96221	LB96221 length 170.0 outside diameter 89.5 flange diameter flange depth 11461-75010	KB96221 length 59.0 comp. height 35.5 -4.4 pin = 24.0 x 61.0 circlip required 13011-75010 13011-75020 13011-75080 13013-75020 13013-75080	KR96221 top 1.75 2nd 1.5 oil 4.0 N-SWT10-125 R-28002/ 28775 T-35904 13011-75010 13011-75020 13011-75080 13013-75020 13013-75080	
			length 170.0 outside diameter 89.5 flange diameter flange depth 11461-75010	length 68.0 comp. height 35.0 -3.9 pin = 20.0 x 66.0 circlip not required 13101-74112	
TOYOTA 3S-FE Bore Dia. 86.0 mm 4 cyl. 1,998 cc DOHC 16V	KBS96230	LB96230 length 177.8 outside diameter 90.0 flange diameter flange depth 11461-61030	KB96230 length 68.0 comp. height 35.0 -3.9 pin = 20.0 x 66.0 circlip not required 13101-74112	KR96230 top 1.5 2nd 1.5 oil 4.0 N-SWT10-119 R-28001/ 28027 T-35885/ 35902 35942 13011-74070/71 13011-74072/80 13011-74081/91 13011-74131 13011-74280 13013-74071/72 13013-74091 13013-74131 13013-74280	
			length 177.8 outside diameter 90.0 flange diameter flange depth 11461-61030	length 68.0 comp. height 35.0 -3.9 pin = 20.0 x 66.0 circlip not required 13101-74112	

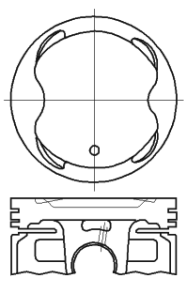
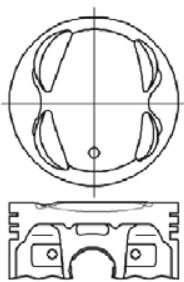
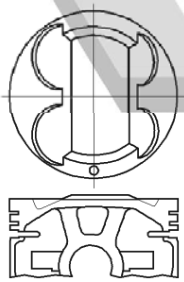

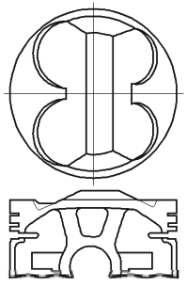
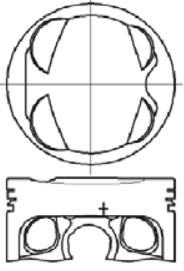
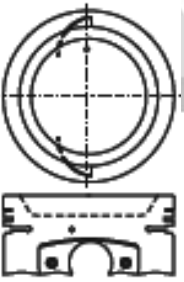
MOTOR - TYP	KOLBEN + RINGE PISTON + RINGS PISTONES + ANILLOS	LAUFBUCHSE CYL. SLEEVE CAMISAS	KOLBENSATZ PISTON SET PISTONES KIT	RINGSATZ RING SET ANILLOS	KOLBEN PISTON PISTONES
TOYOTA 3S-FE Bore Dia. 86.0 mm 4 cyl. 1,998 cc CAMRY CARINA 2 MR2 ST171 SV21 SV25 SW20 (90-92) DOHC 16V	KBS96231	LB96231 length 177.8 outside diameter 90.0 flange diameter flange depth 11461-61030	KB96231 length 68.5 comp. height 35.5 -3.3 pin = 20.0 x 66.0 circlip not required 13101-74120 13103-74120	KR96231 top 1.5 2nd 1.5 oil 4.0 N-SWT10-119 R-28001 / 28027 T-35885 / 35902 35942 13011-74070/71 13011-74072/80 13011-74081/91 13011-74131 13011-74280 13013-74071/72 13013-74091 13013-74131 13013-74280	
			length 65.5 comp. height 35.0 -3.3 pin = 22.0 x 66.0 circlip required 13101-74170 13103-74170	top 1.5 2nd 1.5 oil 4.0 N-SWT10-119 R-28001 / 28027 T-35885 / 35902 35942 13011-74070/71 13011-74072/80 13011-74081/91 13011-74131 13011-74280 13013-74071/72 13013-74091 13013-74131 13013-74280	
TOYOTA 3S-FE Bore Dia. 86.0 mm 4 cyl. 1,998 cc CARINA RAV 4 ST191 SXA1# (92-96) DOHC 16V	KBS96232	LB96232 length 177.8 outside diameter 90.0 flange diameter flange depth 11461-61030	KB96232 length 65.5 comp. height 35.0 -3.3 pin = 22.0 x 66.0 circlip required 13101-74170 13103-74170	KR96232 top 1.5 2nd 1.5 oil 4.0 N-SWT10-119 R-28001 / 28027 T-35885 / 35902 35942 13011-74070/71 13011-74072/80 13011-74081/91 13011-74131 13011-74280 13013-74071/72 13013-74091 13013-74131 13013-74280	
			length 69.2 comp. height 35.1 +2.1 pin = 22.0 x 66.0 circlip required 13101-88362	top 1.2 2nd 1.5 oil 4.0 N-SWT10-141 R-28891 T-35995 13011-74100 13011-88362 13011-88363 13011-88380 13013-88380	
TOYOTA 3S-GEL 3S-GELC Bore Dia. 86.0 mm 4 cyl. 1,998 cc CELICA ST162 (85-88) DOHC 16V	KBS96240	LB96240 length 177.8 outside diameter 90.0 flange diameter flange depth 11461-61030	KB96240 length 69.2 comp. height 35.1 +2.1 pin = 22.0 x 66.0 circlip required 13101-88362	KR96240 top 1.2 2nd 1.5 oil 4.0 N-SWT10-141 R-28891 T-35995 13011-74100 13011-88362 13011-88363 13011-88380 13013-88380	
			length 69.2 comp. height 35.1 +2.1 pin = 22.0 x 66.0 circlip required 13101-88362	top 1.2 2nd 1.5 oil 4.0 N-SWT10-141 R-28891 T-35995 13011-74100 13011-88362 13011-88363 13011-88380 13013-88380	

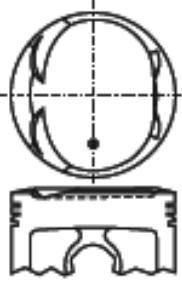
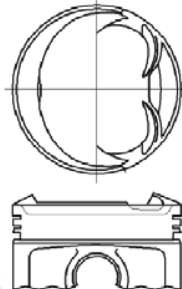
MOTOR - TYP	KOLBEN + RINGE PISTON + RINGS PISTONES + ANILLOS	LAUFBUCHSE CYL. SLEEVE CAMISAS	KOLBENSATZ PISTON SET PISTONES KIT	RINGSATZ RING SET ANILLOS	KOLBEN PISTON PISTONES
TOYOTA 3S-GE Bore Dia. 86.0 mm 4 cyl. 1,998 cc CARINA CELICA MR2 ST182 ST191 SW20 (89- 94) DOHC 16V	KBS21500	LB21500 length 177.8 outside diameter 90.0 flange diameter flange depth 11461-61030	KB21500 length 71.6 comp. height 35.1 +4.5 pin = 22.0 x 66.0 circlip required 13101-88363 13103-88363	KR21500 top 1.2 2nd 1.5 oil 4.0 N-SWT10-141 R-28891 T-35995 13011-74100 13011-88362 13011-88363 13011-88380 13013-88380	
			13101-88363 13103-88363	13011-74100 13011-88362 13011-88363 13011-88380 13013-88380	
TOYOTA 3S-FE Bore Dia. 86.0 mm 4 cyl. 1,998 cc RAV 4 SXA1# SXM10 (96-01) DOHC 16V	KBS96233	LB96233 length 177.8 outside diameter 90.0 flange diameter flange depth 11461-61030	KB96233 length 59.2 comp. height 35.0 -3.0 pin = 22.0 x 56.0 circlip not required 13101-14180 13101-74180 13103-74180	KR96233 top 1.2 2nd 1.2 oil 3.0 N-SWT10-162 R- T-35984 13011-74320 13011-74340 13011-74361 13013-74320 13013-74340	
			13101-14180 13101-74180 13103-74180	13011-74320 13011-74340 13011-74361 13013-74320 13013-74340	
TOYOTA 3Y 3Y-C Bore Dia. 86.0 mm 4 cyl. 1,998 cc DYNA DYNA 150 YU60 YU80 YY211 (84-01) DOHC 16V	KBS96260	LB96260 length 144.0 outside diameter 90.0 flange diameter flange depth 11461-73010	KB96260 length 70.0 comp. height 35.0 -10.3 pin = 22.0 x 66.0 circlip not required 13101-73020 13103-73020 13104-73020 13105-73020	KR96260 top 1.5 2nd 1.5 oil 4.0 N-SWT10-090 R-28720/ 28805 T-35869/ 35930 13011-71010/20/21 13011-71030/31/33 13011-71040 13011-72020 13013-71020/21 13013-71030/31 13014-71020/21 13014-71030/31 13015-71020/21 13015-71030/31	
			13101-73020 13103-73020 13104-73020 13105-73020	13011-71010/20/21 13011-71030/31/33 13011-71040 13011-72020 13013-71020/21 13013-71030/31 13014-71020/21 13014-71030/31 13015-71020/21 13015-71030/31	

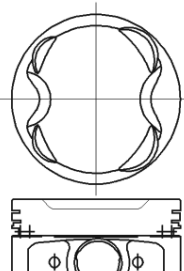
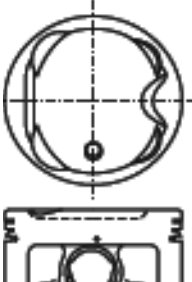
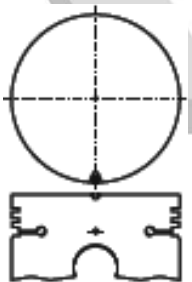
MOTOR - TYP	KOLBEN + RINGE PISTON + RINGS PISTONES + ANILLOS	LAUFBUCHSE CYL. SLEEVE CAMISAS	KOLBENSATZ PISTON SET PISTONES KIT	RINGSATZ RING SET ANILLOS	KOLBEN PISTON PISTONES
TOYOTA 1AZ-FE Bore Dia. 86.0 mm 4 cyl. 1,998 cc AVENSIS RAV4 ACV31 AZT250 (02-) DOHC 16V	KBS10000 skirt MOS2 treated	LB10000 length 144.0 outside diameter 90.0 flange diameter flange depth 11461-73010	KB10000 length 60.8 comp. height 40.8 -6.0	KR10000 top 1.2 2nd 1.2 oil 2.0	
			pin = 22.0 x 56.0 circlip required	N-SWT10-186 R- T-35962/35963 35997	
			13101-28061	13011-28110 13011-28120 13011-28121 13011-74400	
TOYOTA 1TR-FE Bore Dia. 86.0 mm 4 cyl. 1,998 cc HIACE TRH102/112/200 (03-) DOHC 16V	KBS96270 head, top and 2nd ring lands anodized skirt MOS2 treated	LB96270 length 177.8 outside diameter 90.0 flange diameter flange depth 11461-61030	KB96270 length 55.0 comp. height 35.0 +5.5 -6.3	KR96270 top 1.2 2nd 1.2 oil 2.0	
			pin = 22.0 x 56.0 circlip required	N-SDT10-185 R- T-35960	
			13101-75120 13103-75120	13011-75100 13011-75120 13013-75100	
TOYOTA 3S-GE Bore Dia. 86.0 mm 4 cyl. 1,998 cc CORINA (ED) ST18# (89-93) DOHC 16V	KBS21501	LB21501 length 177.8 outside diameter 90.0 flange diameter flange depth 11461-61030	KB21501 length comp. height	KR21501 top 1.2 2nd 1.5 oil 4.0	
			pin = 22.0 x 66.0 circlip required	N-SWT10-141 R-28891 T-35995	
			13101-74090	13011-74100 13011-88362 13011-88363 13011-88380 13013-88380	

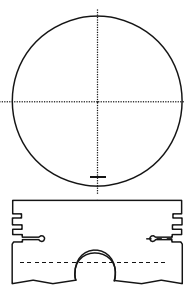
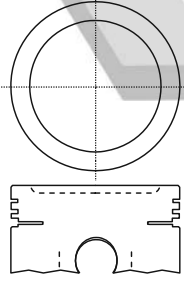
MOTOR - TYP	KOLBEN + RINGE PISTON + RINGS PISTONES + ANILLOS	LAUFBUCHSE CYL. SLEEVE CAMISAS	KOLBENSATZ PISTON SET PISTONES KIT	RINGSATZ RING SET ANILLOS	KOLBEN PISTON PISTONES
TOYOTA 5S-FE Bore Dia. 87.0 mm 4 cyl. 2,164 cc CAMRY CELICA MR2 ST184 SW21 SXV10 SXV20 (90-01) DOHC 16V	KBS82500	LB82500 length outside diameter flange diameter flange depth	length 63.0 comp. height 32.5 -4.8	top 1.5 2nd 1.5 oil 4.0	
			pin = 22.0 x 66.0 circlip required 13101-74080 13101-74130 13103-74080 13103-74130	N-SWT10-133 R-28683 T-35921 / 35943 13011-74150 13011-74190 13011-74260 13011-74261 13011-74290 13011-74300 13013-74150 13013-74190 13013-74290	
TOYOTA 5S-FE Bore Dia. 87.0 mm 4 cyl. 2,164 cc DOHC 16V	KBS82501	LB82501 length outside diameter flange diameter flange depth	length 56.5 comp. height 32.5 -4.3	top 1.2 2nd 1.2 oil 3.0	
			pin = 22.0 x 66.0 circlip required 13101-03060	N-SWT10-166/171 R-28913 T-35944 13011-74370 13011-74380 13011-74410 13013-74370	
TOYOTA 3R Bore Dia. 88.0 mm 4 cyl. 1,897 cc CROWN STOUT RK1000 RS30 RS31 RS40 RS41 RS46 (59-68) SOHC 8V	KBS96300	LB96300 length outside diameter flange diameter flange depth	length 91.0 comp. height 41.0 +0	top 2.5 2nd 2.5 oil 5.0	
			pin = 24.0 x 76.0 circlip required 13101-40010	N-SWT10-022 R-28460 T- 13011-40010 13011-49010 13011-49021	

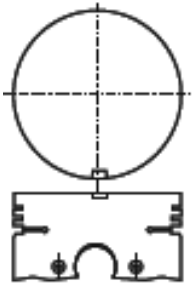
MOTOR - TYP	KOLBEN + RINGE PISTON + RINGS PISTONES + ANILLOS	LAUFBUCHSE CYL. SLEEVE CAMISAS	KOLBENSATZ PISTON SET PISTONES KIT	RINGSATZ RING SET ANILLOS	KOLBEN PISTON PISTONES
TOYOTA 5R Bore Dia. 88.0 mm 4 cyl. 1,994 cc CROWN DYNA STOUT TOYOACE RK100 RS80 RS110 RU2# RU30 RY16 RY31 (72-86) OHV 8V	KBS96310	LB96310 length 150.0 outside diameter 92.0 flange diameter flange depth 11461-44020	KB96310 length 85.0 comp. height 39.0 +0 pin = 22.0 x 75.0 circlip required 13101-44011/12 13101-44013/14/15 13102-44013/14 13103-44013/14/15 13104-44013/14/15 13105-44013/14/15 13106-44013/14 13107-44013/14	KR96310 top 2.0 2nd 2.5 oil 4.0 N-SWT10-069 SXT10-069 R-28550 T-35810/ 35905 13011-44010/11/30 13011-44031/32/33 13011-44040/41/42 13011-44043/44/60 13011-44061/62 13011-44063/73 13012-44032/33/40 13012-44041/60 13013-44032/33/40 13013-44041/43/44 13013-44060/61/62 13014-44032/33/40 13014-44041/43/44 13014-44060/61 13015-44032/33/40 13015-44041/43/44 13015-44060/62 13016-44040/41/60 13017-44040/41/60	
TOYOTA 5R Bore Dia. 88.0 mm 4 cyl. 1,994 cc DYNA TOYOACE RU20 RU30 RY16 RY31 (75-84) OHV 8V	KBS96312	LB96312 length 150.0 outside diameter 92.0 flange diameter flange depth 11461-44020	KB96312 length 85.0 comp. height 39.0 -3.9 pin = 22.0 x 75.0 circlip required 13101-44020 13101-44021 13103-44020 13103-44021 13104-44020 13104-44021 13105-44020 13105-44021	KR96312 top 2.0 2nd 2.5 oil 4.0 N-SWT10-069 SXT10-069 R-28550 T-35810/ 35905 13011-44010/11/30 13011-44031/32/33 13011-44040/41/42 13011-44043/44/60 13011-44061/62 13011-44063/73 13012-44032/33/40 13012-44041/60 13013-44032/33/40 13013-44041/43/44 13013-44060/61/62 13014-44032/33/40 13014-44041/43/44 13014-44060/61 13015-44032/33/40 13015-44041/43/44 13015-44060/62 13016-44040/41/60 13017-44040/41/60	

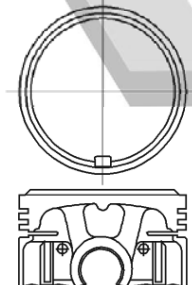
MOTOR - TYP	KOLBEN + RINGE PISTON + RINGS PISTONES + ANILLOS	LAUFBUCHSE CYL. SLEEVE CAMISAS	KOLBENSATZ PISTON SET PISTONES KIT	RINGSATZ RING SET ANILLOS	KOLBEN PISTON PISTONES
TOYOTA 18R Bore Dia. 88.5 mm 4 cyl. 1,968 cc HIACE HILUX RH22/25/32/42 RN22/27/31/36/41/46 (74-83) SOHC 8V	KBS96320	LB96320 length 150.0 outside diameter 92.5 flange diameter flange depth 11461-34010	KB96320 length 84.8 comp. height 39.6 +0 pin = 22.0 x 75.5 circlip required	KR96320 top 2.0 2nd 2.5 oil 4.0 N-SJT10-043 SXT10-04 3 R-28820 T-35831	
			13101-34010 13101-34030/40 13102-34010 13103-34010 13103-34030/40 13104-34010 13105-34010 13105-34030/40	13011-34012/13/20 13011-34021/22/23 13011-34030/40/50 13011-38010/20 13011-38040/60 13012-34022 13013-34022/23 13013-34030/40 13013-38010 13014-34022 13015-34022/23 13015-34030/40 13015-38010	
TOYOTA 20R Bore Dia. 88.5 mm 4 cyl. 2,189 cc HILUX (75-80) SOHC 8V	KBS96330	LB96330 length 150.0 outside diameter 92.5 flange diameter flange depth 11461-34010	KB96330 length 88.6 comp. height 39.0 +2.7 pin = 22.0 x 75.0 circlip required	KR96330 top 2.0 2nd 2.5 oil 4.0 N-SJT10-043 SXT10-04 3 R-28820 T-35831	
			13101-38010 13101-38020	13011-34012/13/20 13011-34021/22/23 13011-34030/40/50 13011-38010/20 13011-38040/60 13012-34022 13013-34022/23 13013-34030/40 13013-38010 13014-34022 13015-34022/23 13015-34030/40 13015-38010	
TOYOTA 20R Bore Dia. 88.5 mm 4 cyl. 2,189 cc HILUX (75-80) SOHC 8V	KBS96331	LB96331 length 150.0 outside diameter 92.5 flange diameter flange depth 11461-34010	KB96331 length 88.9 comp. height 39.0 +2.9 pin = 22.0 x 75.0 circlip required	KR96331 top 2.0 2nd 2.5 oil 4.0 N-SJT10-043 SXT10-04 3 R-28820 T-35831	
			13101-38050	13011-34012/13/20 13011-34021/22/23 13011-34030/40/50 13011-38010/20 13011-38040/60 13012-34022 13013-34022/23 13013-34030/40 13013-38010 13014-34022 13015-34022/23 13015-34030/40 13015-38010	

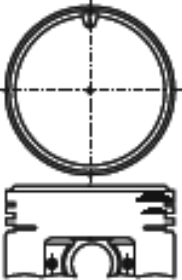
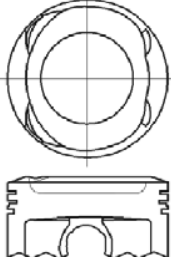
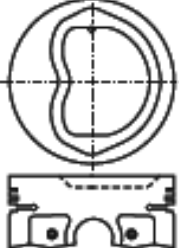
MOTOR - TYP	KOLBEN + RINGE PISTON + RINGS PISTONES + ANILLOS	LAUFBUCHSE CYL. SLEEVE CAMISAS	KOLBENSATZ PISTON SET PISTONES KIT	RINGSATZ RING SET ANILLOS	KOLBEN PISTON PISTONES
TOYOTA 20R (4) RINGS Bore Dia. 88.5 mm 4 cyl. 2,189 cc	KBS96340	LB96340 length 150.0 outside diameter 92.5 flange diameter flange depth 11461-34010	KB96340 length 88.6 comp. height 39.0 +2.7 pin = 22.0 x 75.0 circlip required 13101-38030 13101-38031 13103-38030 13105-38030	KR96340 top 2.0 2nd 2.5 oil 4.0 oil 4.0 N-SJT10-063 R- T-35849 13011-38030 13013-38030 13015-38030	
TOYOTA 2AZ-FE Bore Dia. 88.5 mm 4 cyl. 2,362 cc	KBS48000	LB48000 length 200.0 outside diameter 92.5 flange diameter flange depth	KB48000 length 55.8 comp. height 35.8 -8.6 pin = 22.0 x 56.0 circlip required 13211-28030 13211-28031	KR48000 top 1.2 2nd 1.2 oil 2.0 N-SWT10-172/182 SWT10-187 R- T-35967 13011-23100 13011-28100 13011-28101 13011-28102 13011-28141 13011-28150 13011-28151 13011-28180	
TOYOTA 4Y 4Y-EC Bore Dia. 91.0 mm 4 cyl. 2,237 cc	KBS96350	LB96350 length 164.5 outside diameter 95.0 flange diameter flange depth 11461-73030	KB96350 length 65.0 comp. height 35.0 -6.2 pin = 22.0 x 66.0 circlip not required 13101-73030 13101-73031 13101-73032 13103-73030 13103-73031	KR96350 top 1.5 2nd 1.5 oil 4.0 N-SWT10-111 R-28008 / 28420 T-35887 / 35932 13011-73020/21 13011-73030/31 13011-73032/40 13011-73042 13013-71031/33 13013-73020/21	

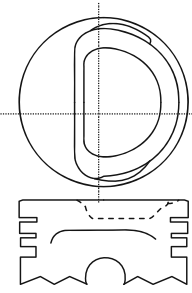
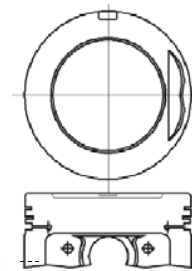
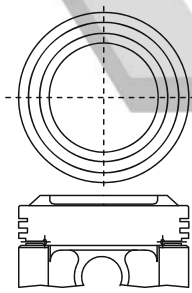

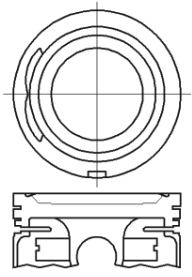
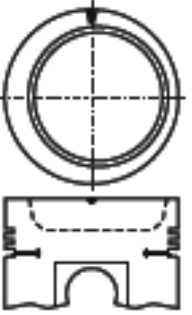
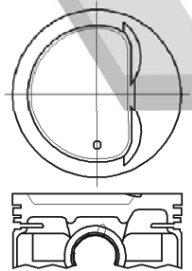
MOTOR - TYP	KOLBEN + RINGE PISTON + RINGS PISTONES + ANILLOS	LAUFBUCHSE CYL. SLEEVE CAMISAS	KOLBENSATZ PISTON SET PISTONES KIT	RINGSATZ RING SET ANILLOS	KOLBEN PISTON PISTONES
TOYOTA 4Y Bore Dia. 91.0 mm 4 cyl. 2,237 cc DYNA YU62 YU63 YU81 (86-87) OHV 8V	KBS96360	LB96360 length 164.5 outside diameter 95.0 flange diameter flange depth 11461-73030	KB96360 length 65.0 comp. height 35.0 -10.0 pin = 22.0 x 66.0 circlip not required 13101-73040 13103-73040	KR96360 top 1.5 2nd 1.5 oil 4.0 N-SWT10-111 R-28008 / 28420 T-35887 / 35932 13011-73020/21 13011-73030/31 13011-73032/40 13011-73042 13013-71031/33 13013-73020/21	
			13101-73040 13103-73040	13011-73020/21 13011-73030/31 13011-73032/40 13011-73042 13013-71031/33 13013-73020/21	
			13101-73040 13103-73040	13011-73020/21 13011-73030/31 13011-73032/40 13011-73042 13013-71031/33 13013-73020/21	
TOYOTA 22R 22R-E 22R-EC Bore Dia. 91.9 mm 4 cyl. 2,366 cc 4 RUNNER CELICA HILUX LAND CRUISER RA65 RJ7# RN5#/6#/7#/8#/12# RN10/58/61/67/90 RU65/75/85 (84-98) SOHC 8V	KBS96370	LB96370 length 180.0 outside diameter 96.0 flange diameter flange depth 11461-35020	KB96370 length 64.0 comp. height 35.0 -2.2 pin = 22.0 x 70.0 circlip required 13101-35030 13101-35031 13101-35032 13103-35040 13103-35041 13103-35042 13105-35040 13105-35041 13105-35042	KR96370 top 1.5 2nd 1.5 oil 4.0 N-SWT10-103 R-28025 / 28541 T-35881 / 35933 35945 13011-35040/41 13011-35050/51 13011-35052/60 13011-35061/70 13011-35071 13013-35040/41 13013-35050/51 13013-35052 13015-35040/41 13015-35051/52	
			13101-35030 13101-35031 13101-35032 13103-35040 13103-35041 13103-35042 13105-35040 13105-35041 13105-35042	13011-35040/41 13011-35050/51 13011-35052/60 13011-35061/70 13011-35071 13013-35040/41 13013-35050/51 13013-35052 13015-35040/41 13015-35051/52	
			13101-35030 13101-35031 13101-35032 13103-35040 13103-35041 13103-35042 13105-35040 13105-35041 13105-35042	13011-35040/41 13011-35050/51 13011-35052/60 13011-35061/70 13011-35071 13013-35040/41 13013-35050/51 13013-35052 13015-35040/41 13015-35051/52	
TOYOTA 22R Bore Dia. 91.9 mm 4 cyl. 2,366 cc 4 RUNNER RN5# RN6# (83-84) SOHC 8V	KBS96380	LB96380 length 180.0 outside diameter 96.0 flange diameter flange depth 11461-35020	KB96380 length 92.0 comp. height 39.0 +6.0 pin = 22.0 x 75.0 circlip required 13101-35010 13101-35020 13103-35030 13105-35030	KR96380 top 2.0 2nd 2.5 oil 4.0 N-SWT10-077 S X T10-077 R-28540 T-35852 13011-35010 13011-35020 13011-35030	
			13101-35010 13101-35020 13103-35030 13105-35030	13011-35010 13011-35020 13011-35030	
			13101-35010 13101-35020 13103-35030 13105-35030	13011-35010 13011-35020 13011-35030	

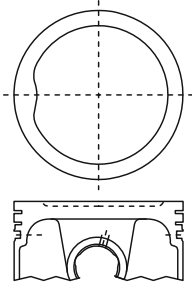
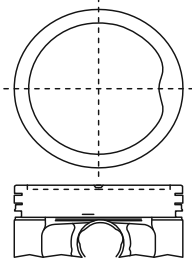
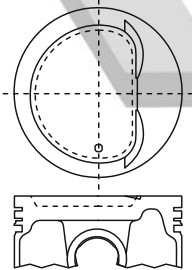
MOTOR - TYP	KOLBEN + RINGE PISTON + RINGS PISTONES + ANILLOS	LAUFBUCHSE CYL. SLEEVE CAMISAS	KOLBENSATZ PISTON SET PISTONES KIT	RINGSATZ RING SET ANILLOS	KOLBEN PISTON PISTONES
TOYOTA 22R-TEC Bore Dia. 91.9 mm 4 cyl. 2,366 cc 4 RUNNER RN55 RN6# (85-88) SOHC 8V	KBS96390	LB96390 length 180.0 outside diameter 96.0 flange diameter flange depth 11461-35020	KB96390 length 63.8 comp. height 34.8 -5.6 pin = 22.0 x 73.0 circlip required	KR96390 top 1.5 2nd 1.5 oil 4.0 N-SWT10-103 R-28025/ 28541 T-35881/ 35933 35945	
			13101-35050 13103-35050 13105-35050	13011-35040/41 13011-35050/51 13011-35052/60 13011-35061/70 13011-35071 13013-35040/41 13013-35050/51 13013-35052 13015-35040/41 13015-35051/52	
TOYOTA 5P Bore Dia. 93.0 mm 4 cyl. 2,771 cc FORKLIFT SOHC 8V	KBS96400	LB96400 length outside diameter flange diameter flange depth	KB96400 length 97.2 comp. height 52.2 -17.1 pin = 27.0 x 74.0 circlip required	KR96400 top 2.5 2nd 2.5 oil 4.0 N-SWT10-048 R- T-	
			13101-78101 13101-96101	13011-96102	
TOYOTA 2RZ Bore Dia. 95.0 mm 4 cyl. 2,438 cc COMUTER HIACE RZH10#/103/105/113 RZH115/117/125 (89-95) SOHC 8V	KBS96410	LB96410 length outside diameter flange diameter flange depth	KB96410 length 67.6 comp. height 35.5 -5.7 pin = 24.0 x 70.0 circlip required	KR96410 top 1.75 2nd 1.5 oil 4.0 N-SWT10-127 R-28185/ 28315 28653 T-35952/ 35956	
			head, top and 2nd ring lands anodized	13101-75020 13103-75020	

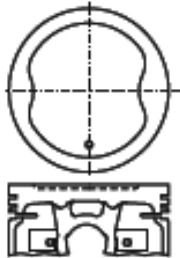
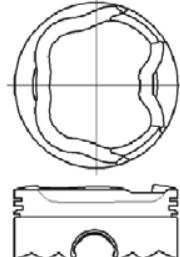
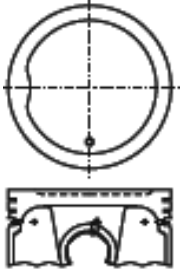
MOTOR - TYP	KOLBEN + RINGE PISTON + RINGS PISTONES + ANILLOS	LAUFBUCHSE CYL. SLEEVE CAMISAS	KOLBENSATZ PISTON SET PISTONES KIT	RINGSATZ RING SET ANILLOS	KOLBEN PISTON PISTONES
TOYOTA 3RZ-FE Bore Dia. 95.0 mm 4 cyl. 2,693 cc 4 RUNNER DYNA 200 HIACE S.B.V RCH13/19/23/29 RU100 RZN18# (95-) DOHC 16V	KBS96420 head, top and 2nd ring lands anodized skirt MOS2 treated	LB96420 length 177.8 outside diameter 99.0 flange diameter flange depth	KB96420 length 61.0 comp. height 37.5 -2.6 pin = 24.0 x 70.0 circlip required 13101-75040 13101-75041 13103-75040 13103-75041	KR96420 top 1.5 2nd 1.5 oil 4.0 N-SWT10-139 R-28313 T- 13011-75040 13011-75041 13013-75040 13013-75041	
			13101-75040 13101-75041 13103-75040 13103-75041	13011-75040 13011-75041 13013-75040 13013-75041	
TOYOTA 2RZ-FE Bore Dia. 95.0 mm 4 cyl. 2,438 cc HILUX RZN168 RZN173 (97-98) DOHC 16V	KBS96430 head, top and 2nd ring lands anodized skirt MOS2 treated	LB96430 length outside diameter flange diameter flange depth	KB96430 length 58.9 comp. height 35.5 -0.8 pin = 24.0 x 70.0 circlip required 13101-75070 13103-75070	KR96430 top 1.5 2nd 1.5 oil 4.0 N- R-28313 T- 13011-75040 13013-75040	
			13101-75070 13103-75070	13011-75040 13013-75040	
TOYOTA 2RZ-E Bore Dia. 95.0 mm 4 cyl. 2,438 cc COMUTER HIACE VAN RZH103/105 RZH113/115/155 RCH12/22/28 (95-) SOHC 8V	KBS96440	LB96440 length outside diameter flange diameter flange depth	KB96440 length 58.1 comp. height 35.2 -6.0 pin = 24.0 x 70.0 circlip required 13101-75080 13103-75080	KR96440 top 1.75 2nd 1.5 oil 4.0 N-SWT10-127 R-28185 / 28315 28653 T-35952 / 35956 13011-75030 13011-75060 13011-75070 13011-75110 13011-76010 13011-76050 13013-75030 13013-75070	
			13101-75080 13103-75080	13011-75030 13011-75060 13011-75070 13011-75110 13011-76010 13011-76050 13013-75030 13013-75070	

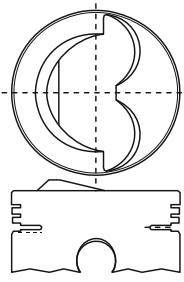
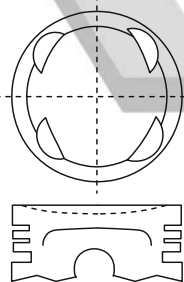

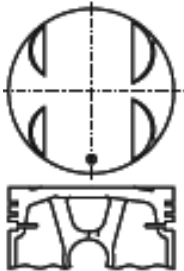

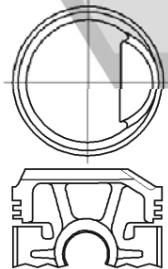
MOTOR - TYP	KOLBEN + RINGE PISTON + RINGS PISTONES + ANILLOS	LAUFBUCHSE CYL. SLEEVE CAMISAS	KOLBENSATZ PISTON SET PISTONES KIT	RINGSATZ RING SET ANILLOS	KOLBEN PISTON PISTONES
TOYOTA 2TZ-FE Bore Dia. 95.0 mm 4 cyl. 2,438 cc PREVIA TCR10 TCR20 (92-96) DOHC 16V	KBS78500	LB78500 length outside diameter flange diameter flange depth	KB78500 length 67.5 comp. height 35.5 -2.5 pin = 24.0 x 70.0 circlip required 13101-76041 13103-76041	KR78500 top 1.75 2nd 1.5 oil 4.0 N-SWT10-127 R-28185/ 28315 28653 T-35952/ 35956 13011-75030 13011-75060 13011-75070 13011-75110 13011-76010 13011-76050 13013-75030 13013-75070	
TOYOTA 2TR-FE Bore Dia. 95.0 mm 4 cyl. 2,694 cc HIACE TRH21# (04-) DOHC 16V	KBS96450	LB96450 length 177.8 outside diameter 99.0 flange diameter flange depth	KB96450 length 59.3 comp. height 39.3 -4.5 -8.6 pin = 22.0 x 62.0 circlip required 13101-75130 13103-75130	KR96450 top 1.2 2nd 1.2 oil 2.0 N-SDT10-193 R- T-35961 13011-75110 13011-75130 13013-75110	
TOYOTA 3RZ-FE Bore Dia. 95.0 mm 4 cyl. 2,693 cc 4 RUNNER DYNA 200 HIACE S.B.V RCH13/19/23/29 RU100 RZN18# (95-) DOHC 16V	KBS96460	LB96460 length 177.8 outside diameter 99.0 flange diameter flange depth	KB96460 length 61.0 comp. height 37.5 -2.6 pin = 24.0 x 70.0 circlip required	KR96460 top 1.75 2nd 1.5 oil 4.0 N-SWT10-127 R-28185/ 28315 28653 T-35952/ 35956 13011-75030 13011-75060 13011-75070 13011-75110 13011-76010 13011-76050 13013-75030 13013-75070	

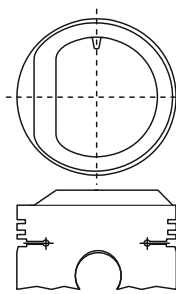
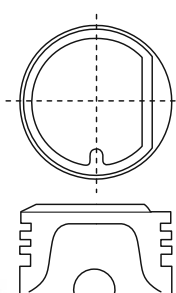
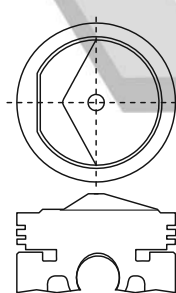

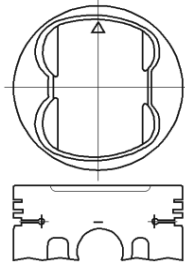
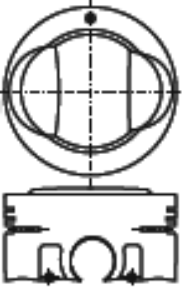
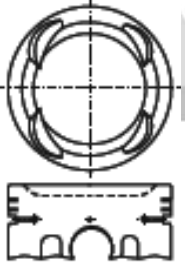

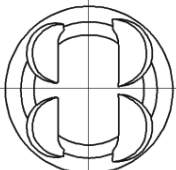
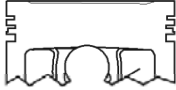
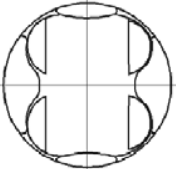

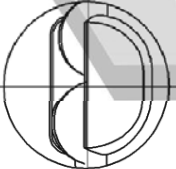
MOTOR - TYP	KOLBEN + RINGE PISTON + RINGS PISTONES + ANILLOS	LAUFBUCHSE CYL. SLEEVE CAMISAS	KOLBENSATZ PISTON SET PISTONES KIT	RINGSATZ RING SET ANILLOS	KOLBEN PISTON PISTONES
TOYOTA 1G-E Bore Dia. 75.0 mm 6 cyl. 1,988 cc CRESSIDA GX6# (82-85) SOHC 12V	KBS96470	LB96470 length 140.0 outside diameter 79.0 flange diameter flange depth	KB96470 length 67.5 comp. height 32.5 +5.0 pin = 18.0 x 61.0 circlip required 13101-70020 13103-70020 13104-70020 13105-70020	KR96470 top 1.5 2nd 1.5 oil 4.0 N-SWT10-073 S X T10-073 R-28690 T-35858 13011-70010 13011-70030 13011-70080 13013-70030 13013-70080 13014-70030 13014-70080 13015-70030 13015-70080	
TOYOTA 1G-GZE Bore Dia. 75.0 mm 6 cyl. 1,988 cc CRESTA GX81 (88-90) DOHC 24V	KBS96480	LB96480 length 140.0 outside diameter 79.0 flange diameter flange depth	KB96480 length 62.5 comp. height 32.5 -5.0 pin = 20.0 x 61.0 circlip required 13101-70040 13103-70040	KR96480 top 1.5 2nd 1.5 oil 4.0 N-SWT10-073 S X T10-073 R-28690 T-35858 13011-70010 13011-70030 13011-70080 13013-70030 13013-70080 13014-70030 13014-70080 13015-70030 13015-70080	

MOTOR - TYP	KOLBEN + RINGE PISTON + RINGS PISTONES + ANILLOS	LAUFBUCHSE CYL. SLEEVE CAMISAS	KOLBENSATZ PISTON SET PISTONES KIT	RINGSATZ RING SET ANILLOS	KOLBEN PISTON PISTONES
TOYOTA 1G-FE Bore Dia. 75.0 mm 6 cyl. 1,988 cc DOHC 24V	KBS96490	LB96490 length 140.0 outside diameter 79.0 flange diameter flange depth	KB96490 length 62.5 comp. height 32.0 +0	KR96490 top 1.5 2nd 1.5 oil 4.0	
			pin = 18.0 x 61.0 circlip not required	N-SWT10-073 S X T10-073 R-28690 T-35858	
			13011-70010 13011-70030 13011-70080 13013-70030 13013-70080 13014-70030 13014-70080 13015-70030 13015-70080		
TOYOTA 1G-GEU Bore Dia. 75.0 mm 6 cyl. 1,988 cc CHASER MARK II SOARER GX71 GZ10 (82-85) DOHC 24V	KBS96500	LB96500 length 140.0 outside diameter 79.0 flange diameter flange depth	KB96500 length 62.5 comp. height 32.5 -2.3	KR96500 top 1.2 2nd 1.5 oil 2.8	
			pin = 18.0 x 61.0 circlip required	N- R-28963 T-	
			13101-88300 13103-88300	13011-88300 13013-88300	
TOYOTA 2M Bore Dia. 75.0 mm 6 cyl. 2,253 cc CROWN (66-72) SOHC 12V	KBS96510	LB96510 length outside diameter flange diameter flange depth	KB96510 length 80.2 comp. height 33.5 +8.7	KR96510 top 2.0 2nd 2.0 oil 4.0	
			pin = 22.0 x 63.0 circlip required	N-SXT10-004 R-28480 T-35816	
			13101-42010	13011-41011 13011-41015 13011-41040	

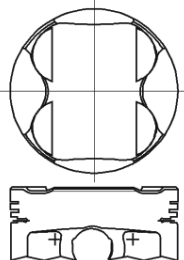

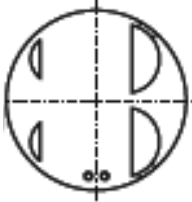
MOTOR - TYP	KOLBEN + RINGE PISTON + RINGS PISTONES + ANILLOS	LAUFBUCHSE CYL. SLEEVE CAMISAS	KOLBENSATZ PISTON SET PISTONES KIT	RINGSATZ RING SET ANILLOS	KOLBEN PISTON PISTONES
TOYOTA 2M Bore Dia. 75.0 mm 6 cyl. 2,253 cc CROWN (66-72) SOHC 12V	KBS96511	LB96511 length outside diameter flange diameter flange depth	length 78.1 comp. height 32.9 +7.2	top 2.0 2nd 2.0 oil 4.0	
			pin = 22.0 x 64.0 circlip required	N-SWT10-004 R-28480 T-35816	
			13101-42011	13011-41011 13011-41015 13011-41040	
TOYOTA 4M Bore Dia. 80.0 mm 6 cyl. 2,563 cc SOHC 12V	KBS96520	LB96520 length outside diameter flange diameter flange depth	length 74.5 comp. height 33.3 +3.2	top 2.0 2nd 2.0 oil 4.0	
			pin = 22.0 x 63.0 circlip required	N-SXT10-041 R-28010 T-35832	
			13101-45010	13011-45021 13011-45040 13011-46030 13013-45021 13013-45040 13014-45021 13014-45040 13015-45021 13015-45040	
TOYOTA 4M Bore Dia. 80.0 mm 6 cyl. 2,563 cc CROWN MS8# MS95 (74-76) SOHC 12V	KBS96521	LB96521 length outside diameter flange diameter flange depth	length 80.5 comp. height 32.8 +9.7	top 2.0 2nd 2.0 oil 4.0	
			pin = 22.0 x 63.5 circlip required	N-SXT10-041 R-28010 T-35832	
			13101-45011 13103-45011 13104-45011 13105-45011	13011-45021 13011-45040 13011-46030 13013-45021 13013-45040 13014-45021 13014-45040 13015-45021 13015-45040	

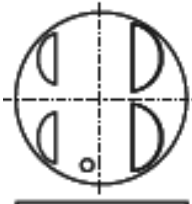
MOTOR - TYP	KOLBEN + RINGE PISTON + RINGS PISTONES + ANILLOS	LAUFBUCHSE CYL. SLEEVE CAMISAS	KOLBENSATZ PISTON SET PISTONES KIT	RINGSATZ RING SET ANILLOS	KOLBEN PISTON PISTONES
TOYOTA 7M-GE Bore Dia. 83.0 mm 6 cyl. 2,954 cc CRESSIDA WAGON SUPRA MA70 MX75 (88-93) DOHC 24V	KBS96550	LB96550 length outside diameter flange diameter flange depth	length 71.0 comp. height 33.0 -2.9	top 1.5 2nd 1.5 oil 4.0	
			pin = 22.0 x 66.0 circlip required 13101-42060 13101-42068 13101-42070 13103-42070	N-SWT10-079/115 R-28806/ 28970 T-35860/ 35893 13011-42010/11 13011-42020/30 13011-42040/60 13011-43050/80 13013-42011/12 13013-42040/60 13013-43050/80 13014-43050/80 13015-43050/80	
TOYOTA 5M-GE Bore Dia. 83.0 mm 6 cyl. 2,759 cc CELICA CROWN MA61 MS123 (84-87) SOHC 12V	KBS96560	LB96560 length outside diameter flange diameter flange depth	length 74.1 comp. height 33.0 +3.3	top 1.5 2nd 1.5 oil 4.0	
			pin = 22.0 x 66.0 circlip required 13101-43051 13103-43051 13104-43051 13105-43051	N-SWT10-079/115 R-28806/ 28970 T-35860/ 35893 13011-42010/11 13011-42020/30 13011-42040/60 13011-43050/80 13013-42011/12 13013-42040/60 13013-43050/80 13014-43050/80 13015-43050/80	
TOYOTA 7M-GTE Bore Dia. 83.0 mm 6 cyl. 2,954 cc PUPRA MA70 (88-93) DOHC 24V	KBS96570	LB96570 length outside diameter flange diameter flange depth	length 71.0 comp. height 33.0 -5.6	top 1.5 2nd 1.5 oil 4.0	
			pin = 22.0 x 66.0 circlip required 13101-42050 13101-42080 13103-42080	N-SWT10-079/115 R-28806/ 28970 T-35860/ 35893 13011-42010/11 13011-42020/30 13011-42040/60 13011-43050/80 13013-42011/12 13013-42040/60 13013-43050/80 13014-43050/80 13015-43050/80	

MOTOR - TYP	KOLBEN + RINGE PISTON + RINGS PISTONES + ANILLOS	LAUFBUCHSE CYL. SLEEVE CAMISAS	KOLBENSATZ PISTON SET PISTONES KIT	RINGSATZ RING SET ANILLOS	KOLBEN PISTON PISTONES
TOYOTA 2JZ-GE Bore Dia. 86.0 mm 6 cyl. 2,997 cc GS300 SUPRA JAZ80 JZS147 (93-97) DOHC 24V	KBS96580	LB96580	KB96580	KR96580	 
TOYOTA 3VZ-FE Bore Dia. 87.5 mm 6 cyl. 2,958 cc CAMRY (WG) VCV10 (91-96) DOHC 24V	KBS96590	LB96590	KB96590	KR96590	 
TOYOTA 3VZ-E (L/R) Bore Dia. 87.5 mm 6 cyl. 2,958 cc 4 RUNNER HILUX VZN10/85/9# VZN120/130 (91-95) DOHC 12V	KBS96600	LB96600	KB96600	KR96600	 

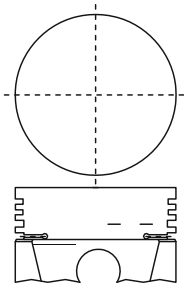
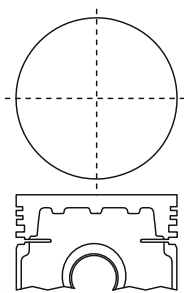
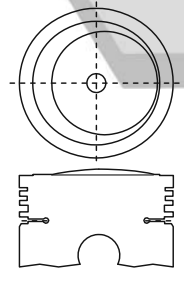
MOTOR - TYP	KOLBEN + RINGE PISTON + RINGS PISTONES + ANILLOS	LAUFBUCHSE CYL. SLEEVE CAMISAS	KOLBENSATZ PISTON SET PISTONES KIT	RINGSATZ RING SET ANILLOS	KOLBEN PISTON PISTONES
TOYOTA 2VZ-FE Bore Dia. 87.5 mm 6 cyl. 2,507 cc CAMRY ES250 VZV21 (88-91) DOHC 24V	KBS96610	LB96610 length outside diameter flange diameter flange depth	KB96610 length 65.0 comp. height 32.2 -2.1 pin = 21.0 x 62.0 circlip not required 13101-62020 13103-62020	KR96610 top 1.5 2nd 1.5 oil 3.0 N-SWT10-148 R-28321 T- 13011-62040 13013-62040	 
			length 51.2 comp. height 31.2 +0	top 1.2 2nd 1.2 oil 3.0 N-SWT10-177 R-28033 / 28955 T-35935	
			pin = 22.0 x 54.0 circlip required 13101-20010(R) 13301-20010(L)	13011-0A020 13011-20010 13011-20012 13011-20020 13011-20021 13011-20022 13011-20050	
			length 55.2 comp. height 31.2 -1.3 -2.7 pin = 22.0 x 54.0 circlip required 13101-0A020(R) 13301-0A020(L)	top 1.2 2nd 1.2 oil 3.0 N-SWT10-177 R-28033 / 28955 T-35935 13011-0A020 13011-20010 13011-20012 13011-20020 13011-20021 13011-20022 13011-20050	
TOYOTA 1MZ-FE (L/R) Bore Dia. 87.5 mm 6 cyl. 2,994 cc CAMRY MCV10 MCV20 (93-97) DOHC 24V	KBS96620	LB96620 length outside diameter flange diameter flange depth	KB96620 length 51.2 comp. height 31.2 +0	KR96620 top 1.2 2nd 1.2 oil 3.0 N-SWT10-177 R-28033 / 28955 T-35935	 
length 55.2 comp. height 31.2 -1.3 -2.7			top 1.2 2nd 1.2 oil 3.0 N-SWT10-177 R-28033 / 28955 T-35935		
pin = 22.0 x 54.0 circlip required 13101-0A020(R) 13301-0A020(L)			13011-0A020 13011-20010 13011-20012 13011-20020 13011-20021 13011-20022 13011-20050		
length 55.2 comp. height 31.2 -1.3 -2.7 pin = 22.0 x 54.0 circlip required 13101-0A020(R) 13301-0A020(L)			top 1.2 2nd 1.2 oil 3.0 N-SWT10-177 R-28033 / 28955 T-35935 13011-0A020 13011-20010 13011-20012 13011-20020 13011-20021 13011-20022 13011-20050		
TOYOTA 1MZ-FE (L/R) Bore Dia. 87.5 mm 6 cyl. 2,994 cc CAMRY MCV20 (00-) DOHC 24V	KBS96621	LB96621 length outside diameter flange diameter flange depth	KB96621 length 55.2 comp. height 31.2 -1.3 -2.7 pin = 22.0 x 54.0 circlip required 13101-0A020(R) 13301-0A020(L)	KR96621 top 1.2 2nd 1.2 oil 3.0 N-SWT10-177 R-28033 / 28955 T-35935	 
length 55.2 comp. height 31.2 -1.3 -2.7			top 1.2 2nd 1.2 oil 3.0 N-SWT10-177 R-28033 / 28955 T-35935		
pin = 22.0 x 54.0 circlip required 13101-0A020(R) 13301-0A020(L)			13011-0A020 13011-20010 13011-20012 13011-20020 13011-20021 13011-20022 13011-20050		
length 55.2 comp. height 31.2 -1.3 -2.7 pin = 22.0 x 54.0 circlip required 13101-0A020(R) 13301-0A020(L)			top 1.2 2nd 1.2 oil 3.0 N-SWT10-177 R-28033 / 28955 T-35935 13011-0A020 13011-20010 13011-20012 13011-20020 13011-20021 13011-20022 13011-20050		

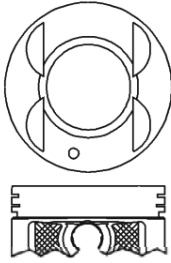
ENGINE MODEL	PISTON+RINGS	LAUFBUCHSE CYL. SLEEVE CAMISAS	KOLBENSATZ PISTON SET PISTONES KIT	RINGSATZ RING SET ANILLOS	KOLBEN PISTON PISTONES
TOYOTA F Bore Dia. 90.0 mm 6 cyl. 3,878 cc	KBS96630	LB96630	KB96630	KR96630	
	LAND CRUISER FJ4# FJ55 (69-72) OHV 12V	length 187.0 outside diameter 94.0 flange diameter flange depth 11462-60010	length 95.5 comp. height 47.5 +0 pin = 25.15 x 80.0 circlip not required 13101-60010 13101-60011 13102-60011 13104-60011 13106-60011 13107-60011 13108-60011 13109-60011 13301-60011	top 3.0 2nd 3.0 oil 4.0 oil 4.0 N-SNT10-026 SWT10-026 R-28610 T-35806 13011-60011 13011-69021 13013-60011 13015-60011 13016-60011 13017-60011 13018-60011 13019-60011 13013-69021 13015-69021 13016-69021 13017-69021	
TOYOTA F Bore Dia. 90.0 mm 6 cyl. 3,878 cc	KBS96631	LB96631	KB96631	KR96631	
	LAND CRUISER FJ4# FJ55 (72-75) OHV 12V	length 187.0 outside diameter 94.0 flange diameter flange depth 11462-60010	length 95.5 comp. height 47.43 +0 pin = 25.15 x 80.0 circlip not required 13101-60020 13102-60020 13103-60020 13104-60020 13105-60020 13107-60020	top 2.0 2nd 2.5 oil 4.0 oil 4.0 N-SCT10-044 SWT10-044 R-28100 T-35835 13011-60040 13012-60040 13013-60040 13014-60040 13015-60040 13017-60040	
TOYOTA F Bore Dia. 90.0 mm 6 cyl. 3,878 cc	KBS96632	LB96632	KB96632	KR96632	
	LAND CRUISER FJ4# FJ55 (73-75) SOHC 12V	length 187.0 outside diameter 94.0 flange diameter flange depth 11462-60010	length 99.4 comp. height 47.5 +3.9 pin = 25.15 x 80.0 circlip not required 13101-60030 13103-60030 13105-60030	top 2.0 2nd 2.5 oil 4.0 oil 4.0 N-SCT10-044 SWT10-044 R-28100 T-35835 13011-60040 13012-60040 13013-60040 13014-60040 13015-60040 13017-60040	

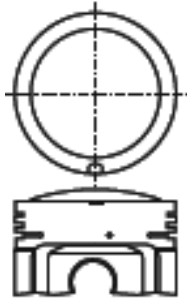
MOTOR - TYP	KOLBEN + RINGE PISTON + RINGS PISTONES + ANILLOS	LAUFBUCHSE CYL. SLEEVE CAMISAS	KOLBENSATZ PISTON SET PISTONES KIT	RINGSATZ RING SET ANILLOS	KOLBEN PISTON PISTONES
TOYOTA 3MZ-FE Bore Dia. 92.0 mm 6 cyl. 3,310 cc RX400H MHU38 (05-07) DOHC 24V	KBS96640 head, top and 2nd ring lands anodized skirt MOS2 treated	LB96640 length outside diameter flange diameter flange depth	KB96640	KR96640	
			length 54.5 comp. height 31.2 -0.6 -1.35 pin = 22.0 x 56.0 circlip required 13101-0A040 13101-20050	top 1.2 2nd 1.2 oil 3.0 N- R- T- 13011-20060 13011-20061	
TOYOTA 5VZ-FE Bore Dia. 93.5 mm 6 cyl. 3,378 cc 4 RUNNER LAND CRUISER 90 VZJ9# VZN18# (95-02) DOHC 24V	KBS96650 head anodized	LB96650 length outside diameter flange diameter flange depth	KB96650	KR96650	
			length 63.0 comp. height 34.0 -4.9 pin = 22.0 x 62.0 circlip required 13101-62060 13103-62060	top 1.5 2nd 1.5 oil 4.0 N-SWT10-178 R-28305 T-35959 13011-62100 13011-62110 13011-62120 13013-62100 13013-62110	
TOYOTA 2F Bore Dia. 94.0 mm 6 cyl. 4,230 cc LAND CRUISER FJ4# FJ40 FJ55 (76-80) SOHC 12V	KBS96660	LB96660 length 191.0 outside diameter 98.0 flange diameter flange depth 11461-61010	KB96660	KR96660	
			length 102.5 comp. height 47.5 +7.0 pin = 25.15 x 71.0 circlip not required 13101-61020 13103-61020 13105-61020 13107-61020	top 2.0 2nd 2.5 oil 4.0 N-SXT10-049 R-28090 T-35836 13011-61010 13011-61040 13013-61010 13013-61020 13015-61010 13015-61020 13017-61010 13017-61020	

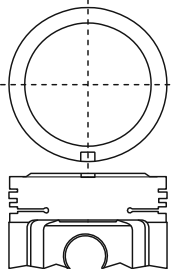
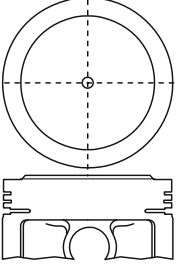
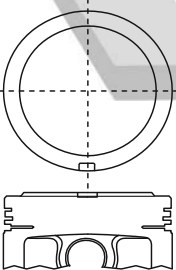
MOTOR - TYP	KOLBEN + RINGE PISTON + RINGS PISTONES + ANILLOS	LAUFBUCHSE CYL. SLEEVE CAMISAS	KOLBENSATZ PISTON SET PISTONES KIT	RINGSATZ RING SET ANILLOS	KOLBEN PISTON PISTONES
TOYOTA 2F Bore Dia. 94.0 mm 6 cyl. 4,230 cc	KBS96661	LB96661 length 191.0 outside diameter 98.0 flange diameter flange depth 11461-61010	KB96661 length 95.75 comp. height 47.55 +0.2 pin = 25.15 x 71.8 circlip not required 13101-61010 13101-61011 13103-61010 13103-61011 13105-61010 13105-61011 13107-61010 13107-61011	KR96661 top 2.0 2nd 2.5 oil 4.0 N-SXT10-049 R-28090 T-35836 13011-61010 13011-61040 13013-61010 13013-61020 13015-61010 13015-61020 13017-61010 13017-61020	
TOYOTA 3F Bore Dia. 94.0 mm 6 cyl. 3,955 cc	KBS96670	LB96670 length 191.0 outside diameter 98.0 flange diameter flange depth 11461-61010	KB96670 length 79.5 comp. height 37.5 +0.3 pin = 22.0 x 75.0 circlip required 13101-61030 13101-61031 13103-61030 13103-61031 13105-61030 13105-61031 13107-61030 13107-61031	KR96670 top 1.5 2nd 1.5 oil 4.0 N-SWT10-106 R-28040/ 28140 T-35882 13011-61060 13011-61061 13013-61060 13013-61061 13015-61060 13015-61061 13017-61060 13017-61061	
TOYOTA 3F-E Bore Dia. 94.0 mm 6 cyl. 3,955 cc	KBS96680	LB96680 length outside diameter flange diameter flange depth	KB96680 length 71.2 comp. height 37.3 +0.2 pin = 22.0 x 75.0 circlip required 13101-61032 13103-61032 13105-61032 13107-61032	KR96680 top 2.0 2nd 2.0 oil 4.0 N-SWT10-140/151 R-28060 T-35914 13011-61062 13013-61062 13015-61062 13017-61062	

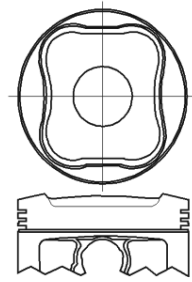
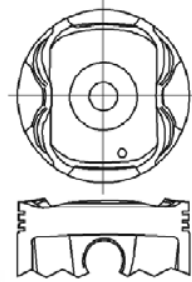
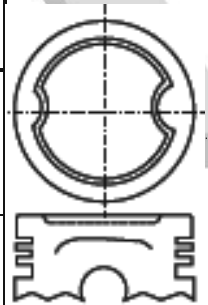
MOTOR - TYP	KOLBEN + RINGE PISTON + RINGS PISTONES + ANILLOS	LAUFBUCHSE CYL. SLEEVE CAMISAS	KOLBENSATZ PISTON SET PISTONES KIT	RINGSATZ RING SET ANILLOS	KOLBEN PISTON PISTONES
TOYOTA 1GR-FE Bore Dia. 94.0 mm 6 cyl. 3,955 cc	KBS31500 head, top and 2nd ring lands anodized skirt MOS2 treated	LB31500 length outside diameter flange diameter flange depth	KB31500 length 53.5 comp. height 32.5 +3.5	KR31500 top 1.2 2nd 1.2 oil 2.0	
			pin = 22.0 x 62.0 circlip required	N-SWT10-195 R- T-35968	
			13101-31030	13011-31100	
LAND CRUISER 120 GRJ12# (03-) DOHC 24V					
TOYOTA 2GR-FE Bore Dia. 94.0 mm 6 cyl. 3,456 cc	KBS32500 head, top and 2nd ring lands anodized skirt MOS2 treated	LB32500 length outside diameter flange diameter flange depth	KB32500 length 50.5 comp. height 31.0 +4.0	KR32500 top 1.2 2nd 1.2 oil 2.0	
			pin = 22.0 x 56.0 circlip required	N-SDT10-194 R- T-36002	
			13101-31090	13011-31130	
CAMRY RX300 GSU35 GSV40 (06-) DOHC 24V					
TOYOTA 1FZ-FE Bore Dia. 100.0 mm 6 cyl. 4,476 cc	KBS86500	LB86500 length outside diameter flange diameter flange depth	KB86500 length 76.0 comp. height 42.0 -4.0	KR86500 top 2.0 2nd 2.0 oil 4.0	
			pin = 26.0 x 62.8 circlip required	N-SWT10-168 R-28021 T-	
			13101-66020	13011-66020	
LAND CRUISER 80 DOHC 24V					

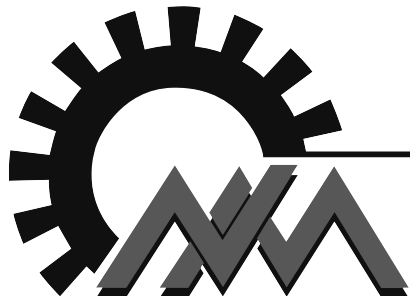

NM-Motorservice

Engine Components



Katalog überreicht durch:
Catalogue provided by:



www.NM-Motorservice.com

NM-Motorservice GmbH • Siemensstrasse 20 • 48619 Heek • Germany
Tel.: +49 (0) 2568 93 44 0 • Fax: +49 (0) 2568 93 44 11